

Title	GEOBIM, BIM integrated geohazard monitoring of at risk slopes and historical retaining structures
Authors	Pantoja Porro, Roberto
Publication date	2022-06-30
Original Citation	Pantoja Porro, R. 2022. GEOBIM, BIM integrated geohazard monitoring of at risk slopes and historical retaining structures. MSc Thesis, University College Cork.
Type of publication	Masters thesis (Research)
Rights	© 2022, Roberto Pantoja Porro. - <a href="https://creativecommons.org/licenses/by-nc-nd/4.0/">https://creativecommons.org/licenses/by-nc-nd/4.0/</a>
Download date	2024-11-08 06:24:22
Item downloaded from	<a href="https://hdl.handle.net/10468/14059">https://hdl.handle.net/10468/14059</a>



**GEOBIM, BIM INTEGRATED GEO HAZARD MONITORING OF AT RISK  
SLOPES AND HISTORICAL RETAINING STRUCTURES.**

A Dissertation

Submitted to the Department of Civil, Structural and Environmental Engineering,  
University College Cork

In the partial fulfilment of the requirements for the degree of  
Masters by Research (MSc)

By

Roberto Pantoja Porro

Student number: 121126657

Head of School: Prof. Jorge Oliveira

Supervised by:

Dr Michael O'Shea

Dr Jimmy Murphy

## Abstract

Over time, structures such as slopes and retaining walls are increasingly deteriorating, resulting in a risk of collapse. Factors such as climate change, human activities, societal development, rapid growth of cities, increasing population and economy make geological disasters occur more frequently than usual. Geological hazards of nature, slope collapse, slope fractures or slope movements have become a problem to be solved by civil engineering. With the advent of low-cost sensors, optical topographic surveying and BIM (Building Information Modelling), such risk could be mitigated and, in some cases, eliminated. The main aim of this research was to use wireless sensors to monitor slopes that are potentially at risk and to incorporate all the information obtained in BIM (Building Information Modelling), in order to make a digitalized vision of the structures in real time. High precision and innovative tools, such as drone flights and slope scanners were utilized for a detailed analysis of the risk of change in the geohazards including soil slopes and historic retaining walls. Through the combination of data from sensors with point clouds generated from drone flights, an early warning system was developed. This early warning system was clearly able to display when there was surface changes therefore highlighting the areas of high risk of collapse. This thesis shows how continuous real-time surveillance of soil slopes and retaining walls can be achieved clearly and concisely, in a cost-effective manner.

<b>ABSTRACT</b> .....	<b>2</b>
<b>LIST OF FIGURES</b> .....	<b>5</b>
<b>LIST OF EQUATIONS</b> .....	<b>7</b>
<b>LIST OF TABLES</b> .....	<b>7</b>
<b>LIST OF ACRONYMS</b> .....	<b>8</b>
<b>LIST OF SYMBOLS</b> .....	<b>8</b>
<b>1. INTRODUCTION</b> .....	<b>1</b>
1.1 BACKGROUND .....	3
1.2 MOTIVATION.....	6
1.3 RESEARCH QUESTIONS .....	7
1.4 APPROACH.....	8
1.5 OUTLINE.....	10
<b>2. STUDY SITE</b> .....	<b>11</b>
2.1 GEOLOGICAL SETTING.....	14
<b>3. LITERATURE REVIEW</b> .....	<b>17</b>
3.1 STRUCTURAL HEALTH MONITORING (SHM) .....	19
3.1.1 SHM case studies .....	21
3.2 DIFFERENT METHODOLOGIES .....	28
3.2.1 Geodetic methods.....	28
3.2.2 Geotechnical methods .....	31
3.2.3 Geophysical methods.....	35
3.2.4 Remote sensing.....	37
3.3 SLOPE INSPECTION .....	40
3.3.1 Routine visual inspections.....	40
3.4 TOPOGRAPHIC SURVEYING .....	41
3.4.1 Laser scanner .....	41
3.4.2 Drone .....	43
3.5 BUILDING INFORMATION MODELLING (BIM) .....	45
3.5.1 Introduction to BIM.....	45
3.5.2 Advantages of using BIM.....	46
3.5.3 Dynamo.....	48
3.5.4 Digital Twin .....	48
3.5.5 Economics of SHM .....	52
3.6 CONCLUSION .....	53
<b>4. DATA COLLECTION METHODOLOGY</b> .....	<b>56</b>
4.1 IDENTIFICATION AND VISUAL INSPECTION OF RETAINING WALLS AND SLOPES .....	56
4.1.1 Laundry Hill .....	59
4.1.2 Hillview Terrace .....	59
4.1.3 Church Street .....	60
4.1.4 Lower Road .....	60
4.1.5 Saint Colman’s Cathedral Buttresses .....	61
4.1.6 Connolly Street.....	62
4.2 TOPOGRAPHIC DATA COLLECTION .....	70
4.2.1 Laser Scanner Data collection.....	70
4.2.2 Drone Surveying methodology.....	74

4.3 REAL-TIME SENSORS DATA COLLECTION .....	77
4.3.1 <i>Sensor Network Design</i> .....	78
4.3.2 <i>Sensors</i> .....	79
4.3.3 <i>Inertial measurement sensor</i> .....	80
4.3.4 <i>Wireless connectivity</i> .....	81
4.3.5 <i>Sensor storage</i> .....	82
4.3.6 <i>Sensor programming</i> .....	83
4.3.7 <i>Field Deployment;</i> .....	88
.....	90
4.4 SHM INTEGRATION WITH BIM PLATFORM .....	90
4.4.1 <i>Early warning methodology</i> .....	92
4.5 VISUALISATION OF SENSOR DATA IN BIM .....	93
4.5.1 <i>Programming requirements;</i> .....	93
4.5.2 <i>Visual Programming</i> .....	94
4.6 VISUALISING THE EARLY WARNING SYSTEM .....	100
4.6.1 <i>Programming scheme</i> .....	101
4.6.2 <i>Data visualisation</i> .....	106
<b>5. RESULTS .....</b>	<b>108</b>
5.1 TOPOGRAPHIC SURVEY RESULTS.....	108
5.1.1 <i>Laser scanner</i> .....	108
5.1.2 <i>Drone</i> .....	114
5.1.3 SENSORS .....	118
5.1.3.1 <i>Case studies</i> .....	119
5.2 INTEGRATED BIM BASED SHM TOOL.....	122
5.2.1 <i>Level 0</i> .....	123
5.2.2 <i>Level 1</i> .....	124
5.2.3 <i>Level 2</i> .....	125
5.3 ECONOMIC ANALYSIS OF BIM SHM SYSTEM.....	127
<b>6. DISCUSSION .....</b>	<b>129</b>
6.1 LIMITATIONS .....	129
<b>7. CONCLUSIONS.....</b>	<b>130</b>
7.1 CONCLUSION SUMMARY.....	130
7.2 TOPOGRAPHIC SURVEILLANCE CONCLUSIONS.....	130
7.3 MONITORING .....	132
7.4 BIM AS AN SHM PLATFORM .....	133
7.5 APPLICATION .....	135
7.6 RECOMMENDATIONS FOR FUTURE WORKS.....	135
<b>APPENDIX 1 .....</b>	<b>137</b>
TECHNICAL CHARACTERISTICS OF ARDUINO UNO WiFi REV2 .....	137
<b>REFERENCES.....</b>	<b>138</b>
<b>IMAGE REFERENCES.....</b>	<b>143</b>

## List of Figures

Figure 1. 1 displays the landslide on Connolly Street slope and its proximity to a primary road (1) .....	5
Figure 1. 2 showcases a section of further partial landslide on the Connolly Street slope (1).....	6
Figure 1. 3 Flow diagram highlighting the steps carried out to develop a GEOBIM SHM .....	10
Figure 2. 1 Aerial view of Cobh highlighting the topography of the town (2) .....	11
Figure 2. 2 Shotcrete protection on a slope in Harbour Row, a slope previously at risk of collapse (3) ....	12
Figure 2. 3 Shotcrete protection on a slope at Saint Colman's Cathedral, previously at risk (3) .....	13
Figure 2. 4 Landslide at the Connolly Street slope prior to any preventative measures (1) .....	14
Figure 2. 5 GSI Classification of landslide susceptibility in the Cobh area (4).....	15
Figure 2. 6 GSI Classification of landslide susceptibility.....	15
Figure 3. 1 Sensor network layout on the Commodore Barry Bridge, USA (5).....	23
Figure 3. 2 Monitoring over the Commodore Barry Bridge, USA (5) .....	23
Figure 3. 3 Sensor monitoring at Cabril Dam, Portugal (6).....	24
Figure 3. 4 Sensor deployment at Cabril Dam, Portugal (6) .....	25
Figure 3. 5 Sensor monitoring at Guangzhou TV tower, China (7) .....	26
Figure 3. 6 Principle of operation of Synthetic Aperture Radar (8).....	30
Figure 3. 7 Principle of LiDAR operation (9).....	30
Figure 3. 8 Extensometer in action (10).....	32
Figure 3. 9 Small Crack Extensometers monitoring cracks (10).....	32
Figure 3. 10 Mechanism of extensometers for vertical movements (10) .....	33
Figure 3. 11 Mechanism of action for an Inclinator (10) .....	34
Figure 3. 12 Mechanism of action of Piezometer (11).....	35
Figure 3. 13 Diagram of potential geophysical methods of surveillance (12) .....	37
Figure 3. 14 Principle of operation of photogrammetry (13).....	39
Figure 3. 15 Infrared Camera Operating Principle (14) .....	39
Figure 3. 16 Chetwynd Viaduct, Cork previously subject to laser scanning technology (15).....	42
Figure 3. 17 Principle of Leica laser scanner operation (16).....	43
Figure 3. 18 Drone Camera for image taking (17).....	44
Figure 3. 19 Quadcopter drone for surveillance (17).....	44
Figure 3. 20 Diagram of the different levels of BIM development.....	46
Figure 3. 21 Application of digital Twins (18) .....	49
Figure 4. 1 Overview of the methodology applied in the research project.....	57
Figure 4. 2 Aerial view of the slope and retaining walls for monitoring in Cobh (19).....	58
Figure 4. 3 Laundry Hill (19).....	59
Figure 4. 4 Hillview Terrace (19) .....	59
Figure 4. 5 Church Street (19).....	60
Figure 4. 6 Lower Road (19).....	61
Figure 4. 7 Saint Colman's Cathedral Buttresses (19).....	62
Figure 4. 8 Partial landslide at the Connolly Street Slope (19).....	63
Figure 4. 9 Design geometry and materials in Plaxis software.....	64
Figure 4. 10 Study of the stability as a function of the water table at low tide.....	65
Figure 4. 11 Slope stresses at low tide.....	66
Figure 4. 12 Total displacements at low tide.....	66
Figure 4. 13 Total incremental displacements at low tide.....	67
Figure 4. 14 Study of the stability as a function of the water table at high tide .....	67
Figure 4. 15 Slope stresses at high tide .....	68

Figure 4. 16 Total incremental displacements of the slope at high tide .....	69
Figure 4. 17 Total strains of the slope at high tide .....	69
Figure 4. 18 Laser scanner in action at the Connolly Street slope, Cobh .....	71
Figure 4. 19 Point cloud resulting from the laser scan of the Connolly Street slope.....	73
Figure 4. 20 Selection of the area to be flown by the drone over the Connolly Street slope, Cobh .....	75
Figure 4. 21 Photogrammetry points collected by the drone .....	76
Figure 4. 22 Overview of Topographic Data Collection .....	79
Figure 4. 23 Arduino Uno WiFi Rev2 (20).....	79
Figure 4. 24 Arduino Uno WiFi Rev2 components (20) .....	80
Figure 4. 25 Inertial measurement sensor (20).....	80
Figure 4. 26 Connection Inertial measurement sensor to Arduino Uno WiFi (20) .....	81
Figure 4. 27 Wireless connectivity (21).....	81
Figure 4. 28 Sensor storage (20).....	82
Figure 4. 29 Sensor measurement axes (22).....	83
Figure 4. 30 Overview of the sensor network design.....	84
Figure 4. 31 Libraries Code .....	85
Figure 4. 32 Modem and Google Sheet connection code .....	85
Figure 4. 33 SD card storage code .....	86
Figure 4. 34 WiFi and SD card connection code.....	86
Figure 4. 35 Sending and Reading data code .....	87
Figure 4. 36 Sensor box applied to the Connolly Street slope .....	88
Figure 4. 37 Waterproof sensor case.....	88
Figure 4. 38 Sensor deployment on Connolly Street slope, Cobh.....	89
Figure 4. 39 Sensor deployment on Connolly Street slope, Cobh.....	89
Figure 4. 40 Aerial view of the location of the Connolly Street slope at Cobh.....	90
Figure 4. 41 Overview of SHM integration and format transfer.....	91
Figure 4. 42 Overview of Sensor Data Collection and study levels .....	93
Figure 4. 43 Programming scheme for mesh creation using a point cloud to Revit through Dynamo. ....	96
Figure 4. 44 Python script for mesh creation.....	97
Figure 4. 45 Cloud points in Dynamo geometry .....	99
Figure 4. 46 Correction of the resulting Python script points .....	99
Figure 4. 47 Point indexes for mesh creation .....	99
Figure 4. 48 Mesh visualisation in Revit .....	100
Figure 4. 49 Overview of the mesh creation programme.....	100
Figure 4. 50 Programming scheme for the design of the Early Warning System marker .....	101
Figure 4. 51 Python script for communication with the database.....	102
Figure 4. 52 Text to number conversion .....	103
Figure 4. 53 Rounding numbers to two decimal places.....	103
Figure 4. 54 Assignment of parameters .....	104
Figure 4. 55 Assignment of parameters II.....	104
Figure 4. 56 ID selection for text and marker .....	104
Figure 4. 57 Setting range limits for the alert level .....	105
Figure 4. 58 Setting range limits for the alert level II.....	105
Figure 4. 59 Set colour scale for results display.....	105
Figure 4. 60 Cobh 3D Visualisation in Revit .....	107
Figure 4. 61 BIM Early Warning System Design Overview.....	107
Figure 5. 1 Laundry Hill; Point Cloud and Mesh.....	110
Figure 5. 2 Hillview Terrace; Point Cloud and Mesh .....	110
Figure 5. 3 Church Street; Point Cloud and Mesh .....	111
Figure 5. 4 Cathedral Buttresses; Point Cloud and Mesh.....	111
Figure 5. 5 Connolly Street slope; Point Cloud and Mesh .....	112

Figure 5. 6 Photographs resulting from the flight over the soil slope on Connolly Street .....	114
Figure 5. 7 Point cloud resulting from drone flight over Connolly St slope, Cobh.....	115
Figure 5. 8 Connolly Street slope mesh.....	117
Figure 5. 9 Connolly Street slope coloured mesh.....	118
Figure 5. 10 Googlesheet spreadsheet .....	118
Figure 5. 11 Sensor data; Level 0.....	120
Figure 5. 12 Sensor data, Level 1.....	121
Figure 5. 13 Sensor data; Level 2.....	121
Figure 5. 14 Point Cloud of Connolly St. slope in Revit.....	122
Figure 5. 15 Googlesheet spreadsheet; Level 0 .....	123
Figure 5. 16 Marker visualisation for Level 0 in Revit.....	124
Figure 5. 17 Marker for Level 0.....	124
Figure 5. 18 Googlesheet spreadsheet; Level 1 .....	124
Figure 5. 19 Marker visualization for Level 1.....	125
Figure 5. 20 Marker for Level 1.....	125
Figure 5. 21 Googlesheet spreadsheet; Level 1 .....	125
Figure 5. 22 Marker visualization for Level 2.....	126
Figure 5. 23 Marker for Level 2.....	126

## List of Equations

Equation 1 Aceleration .....	82
Equation 2 Force and acceleration .....	82
Equation 3 Angular velocity.....	83

## List of Tables

Table 1.Factors increasing landslide risk .....	4
Table 2 BIM interoperability formats .....	47
Table 3 Surveyed walls and soil slope.....	58
Table 4 Dynamo coding library.....	94
Table 5 Summary of the point cloud and mesh characteristics .....	109
Table 6 3D Points from 2D key point Matches .....	116
Table 7 Capital cost of establishing SHM.....	128
Table 8 Ten year cost projection of SHM.....	128



## List of Acronyms

Abbreviation	Description
BIM	Building Information Modelling
SHM	Structural Health Monitoring
FHWA	Federal Highway Administration
ICOLD	International Commission on Large Dams
LNEC	National Laboratory of Civil Engineering
ADM	Aerial Deformation Measurement
SAR	Synthetic Aperture Radar
LiDAR	Light Detection and Ranging
IRT	Infrared Thermography
HSI	Hyperspectral Imaging
GNSS	Global Navigation Satellite System
GPS	Global Positioning System
IFC	Industry Foundation Classes
CDBB	Centre for Digital Built Britain
BEIS	Department for Business, Energy & Industry Strategy
MEMS	Micro Electro Mechanical System
EWS	Early Warning System
UAV	Unnamed Aerial Vehicle

## List of Symbols

Symbol	Description	Unit
KN	Kilonewton	
GHz	Gigahertz	
h	Hour	s
m	Metre	
m <sup>2</sup>	Square meter	
mAh	Miliampere hour	
$\alpha$	acceleration	m/s <sup>2</sup>
v	Velocity	
t	Time	s
F	Force	N
m	Mass	Kg
$\omega$	Angular velocity	s <sup>-1</sup>
$\pi$	pi	
$\gamma_{\text{unsat}}$	Unsaturated unit weight	KN/m <sup>3</sup>
$\gamma_{\text{sat}}$	Saturated unit weight	KN/m <sup>3</sup>
v	Poisson's ratio	
$\varphi$	Friction angle	°
$\psi$	Dilatancy angle	°
E	Young's modulus	KN/m <sup>2</sup>
C	Cohesion	KN/m <sup>2</sup>

## 1. Introduction

Mass movement and landslides occur due to a multitude of factors such as rainfall, coastal erosion, human interaction (1). The size of a landslide may appear small however its effect could be extensive resulting in loss of infrastructure, land, and even lives (2). Ireland is not a country considered to be impacted greatly by significant geohazard events however it is a country that experiences landslides of different magnitude (3).

Towns and cities built in locations exposed to adverse conditions are at increased risk of landslides(4). One such example of this is Cobh, Co. Cork. This town was built on the land of steep topography located overlooking Cork harbour. Its soil is primarily sandstone and so, due to the location and strata beneath the town, Cobh relies heavily on retaining walls for the preservation and safety of the town. Due to an increasing population and changing climates, the retaining walls of Cobh as well as the soil slopes in the area are gradually deteriorating and some such structures have collapsed (5). These collapses promoted preventative measures being carried out on high risk areas in the past however these measures were extremely costly and difficult to carry out (6). Following the completion of these works further high-risk structures were identified that require continuous monitoring and will require stabilising measures to prevent significant deterioration.

Current methods for geo-structural surveillance require lengthy periods of analyses and monitoring of structures at risk of collapse. The time needed for adequate surveillance is lengthy whilst the technology used is expensive (7). The cost of surveillance is high whilst the results are of low yield, given that these analyses only occur up to four times a year. In the interval between analysis, the damage that could occur may be dramatic whilst the repairs required for such change's damages may be extensive. There is always a risk to human life if an at-risk structure is not adequately monitored and intervention applied in time.

It is clear that expansion and development of current surveillance methods is required in order to provide real-time, high quality results continuously so that adequate information on at risk structures is known to prevent further deterioration and losses. Novel technologies need to be applied to further enhance the surveillance methods in a manner that is quicker in time and cheaper in cost. The results of such analyses need to be clear in their information and also identify areas requiring intervention at optimal times.

This research project aims to combine the use of novel technologies such as drones, sensors and BIM software to develop an early warning system. This early warning system aims to provide continuous data on at risk structures under surveillance remotely. Following the deployment of laser scanners and drone software, 3D object-oriented models of the structure under surveillance will be created. Through the use of sensors, the slope or retaining wall surface behaviour can be monitored and any movements identified. By combining the sensor data with the 3D object-oriented model, using Revit software, a BIM structural health monitoring early warning system will be developed.

The above methodology was applied to a number of at-risk structures in Cobh, Cork. One soil slope was at significantly high risk of collapse and so was the focus of this study. Following the use of a drone to capture a series of images, a point cloud was developed of the soil slope. By using an accelerometer and gyroscope sensor, live data of the slope surface movements were obtained. This data was then incorporated, through Dynamo and Revit, to formulate a BIM structural health monitoring system that was cheap, effective and accurate in its results.

Through this research thesis, it can be seen that novel technologies provide a means for accurate measurement and surveillance of at-risk structures in a manner that is less costly financially and in time. These methods also provide results that are more sensitive to structural changes and therefore enable for early intervention and prevention of structural collapse.

## 1.1 Background

The effects of climate change i.e. extreme weather variations, heavy rainfalls and strong winds, puts soil slopes and retaining masonry walls under increased stress. Retaining masonry walls are important and necessary barriers that protect infrastructures, overcoming landslide hazards that could potentially happen by withstanding the lateral pressure of soil and rock masses (8). Over time, natural deterioration occurs however, extreme weather events caused by climate change accelerate the destruction of these structures of importance. The destruction and deterioration of masonry walls results in landslides which pose large socioeconomic risks for communities (2, 9). The term landslide describes a number of processes resulting in the downward and outward movement of materials under the force of gravity (3).

The level of mass movement, more specifically rotational landslides, has intensified in recent years. These landslides are caused by the combination of a number of natural factors; topography, heavy rainfall, overloaded housing, poor solid waste disposal, seismicity (10). Landslides are considered to be the most destructive geological processes affecting humans, resulting in a large amount of economic loss as well as putting lives at risk (11). 90% of the losses caused by landslides are considered avoidable, through early detection of areas of weakness and early intervention with preventative measures (10). Although the magnitude, and effect of a landslide can vary with the consequences causing serious disruption and loss of lives, the size of the landslide does not often correlate with the consequences. A small landslide could result in road or transport infrastructure collapse, injury or death (3).

Based on the geographical location of Ireland, along with the soil types found across the country, it is not considered to be high risk for major geohazard events. However, landslides have, and will continue to occur with serious consequences. The combination of complex terrain with extreme weather events such as heavy rainfall lowers the threshold for landslides in at risk areas (12, 13). Several factors increase the risk of landslides (Table 1) which are bound to increase due to changing climate. Although considered a benign country in relation to geohazards and landslides, Ireland is not immune to such events and their consequences. Events, such as that in Castlegarde, Co. Limerick resulting in 21 deaths (3, 14), or Cobh Co Cork, resulting in the death of a child

highlight how these events occur and impact this country. A total of 34 people have died to date in landslides in Ireland (15). The effect of such events, irrespective of their size, needs to be analysed and assessed to implement measures to prevent further damage and avoid possible losses (15). In late 2003, two major landslides occurred in Ireland resulting in millions of euro worth of damage. One of these landslides occurred in Derrybrien, Co. Galway resulted in the dislodgement of 450,000 cubic metres of peat over a 32Km<sup>2</sup> area (15). There were no deaths following these two events however they resulted in a shift in perspectives towards landslides in Ireland and raised awareness towards their seriousness. Figure 1.1 shows an example of a landslide on Connolly Street in Cobh in close proximity to a busy road and a number of houses that illustrates some of the dangers.

*Table 1. Factors increasing landslide risk*

<b>Underlying Rock</b>	Rock type, grain size, what the rock is made of, degree of weathering
<b>Physical features</b>	slope elevation, slope incline, direction the slope is facing
<b>Drainage</b>	slope drainage direction, how fast the ground drains
<b>Land Cover</b>	vegetation type, land use
<b>Rainfall</b>	total amount, intensity, time interval
<b>Natural erosion</b>	slope surface, base of slope
<b>Man-made</b>	undercutting of slopes, removal of retaining walls, land drainage



*Figure 1. 1 displays the landslide on Connolly Street slope and its proximity to a primary road (1)*

This research proposes a novel method of slope surveillance that is more cost effective, accurate and accessible than current techniques used for slope and structural monitoring. In order to accurately assess of the current state of an at-risk slope, it is necessary to compile different geometric, geotechnical, geological and hydrological parameters that allow a model to be developed that mimics reality and thus allows for the topographical and geotechnical behaviour of the slope to be deduced.

In the analysis of potential landslides and slope collapse, one of the most important aspects to be considered in a slope stability analysis is the safety factor, which expresses the ratio between the resistant forces of the terrain and the destabilising forces (16). When this value exceeds one, it indicates stable conditions whilst, on the contrary, when it indicates values lower than one, it indicates unstable conditions. When the result is equal to one, it is at the breaking point which means that the resistant forces are equal to the destabilising forces and the slopes has the potential to become destabilised with little additional destabilising forces (16).

Traditionally, the task of monitoring the structural health of a slope is an arduous task to carry out that requires skilled personnel and a lot of time. However, in the event of deterioration of slope stability, the result of the analysis identifies the point of damage

and therefore facilitates the necessary corrective measures to be applied to the structural model to prevent future landslides from occurring (17).



*Figure 1. 2 showcases a section of further partial landslide on the Connolly Street slope (1)*

Consequently, the results provided by structural health monitoring includes multiple points of assessment of the slope under study. Therefore, it is important to recognise and classify any type of movement or damage that could negatively affect the structural integrity and stability. It is important to recognise and classify the materials that compose it, and it will be possible to estimate the behaviour of the terrain and its possible reactions to different stresses.

## 1.2 Motivation

The current techniques used for the surveillance of soil slopes and retaining structures at risk of damage are complex in their nature as they are time- and resource- intensive laborious undertakings. It requires expensive tools to allow for accurate evaluation and therefore the identification of structural problems of the slope stability (18). Due to the numerous factors implicated in the damage to soil slopes and retaining structures of importance, the task of structural monitoring is made difficult by prolonging the surveillance and affecting the accuracy of results.

Prior to the analysis of the structural behaviour of a slope, the various material constituents of the slope or structure are required, as well as their strata and measurements. To do this, it is necessary to carry out a geotechnical borehole, which allows for a geotechnical survey of the terrain. Boreholes are small diameter drillings,

normally carried out mechanically, from which core samples are obtained from the drilled ground, samples which, after tests are carried out, determine the characteristics and properties of the ground. Although important in the process of slope surveillance, this is an invasive procedure. In the surveillance of an active slope with risk of landslide, the process of carrying out a borehole has the potential to worsen the slopes stability with the possibility of causing an acute deterioration in the slope stability, therefore increasing the risk exponentially. A non-invasive slope surveillance technique is required that allows for accurate active monitoring of slope changes without contributing to slope damage.

There are various approaches to slope monitoring at present (19), however each of these processes lack the ability to continuously provide data whilst they are also labour intensive. The requirements of structural monitoring vary according to the structure however it is a mechanical procedure carried out by experts that involve several days of preparation as well as days of work to carry out the procedure. Therefore, it is clear that current methods are cost and time intensive. Through the development of a digital real time structural health monitoring system, the costs of surveillance are reduced dramatically whilst providing more in-depth well-rounded information of structural health (20).

Building information modelling (BIM) allows for the integration of multi-disciplinary data to form a digital representation of a structure allowing for better visibility, clarity in decision making and financial effectiveness (21). BIM was initially developed and used in traditional construction, whereby it was implemented during the construction stages of a building for optimal design, operation and maintenance of the building. By using the same principles and technology, BIM can be applied to geotechnical engineering whereby it can be adapted to allow for continuous monitoring of slopes whilst also aiding in preventative measures if required in a deteriorating slope or retaining wall (22).

### 1.3 Research questions

Two areas have been identified that require further research and development. Firstly, from a geomorphological point of view, the quality of the 3D modelling results of the slopes require further information and expansion. Secondly, the evolution of the



structural behaviour over time needs to be developed to provide continuous real-time data to be obtained. To further this understanding, the following research questions and objectives were posed:

- How can a true-to-life 3D object-oriented model be developed and what alternatives are there?
- How can structural health surveillance be carried out on a slope?
- Is there a means of linking such 3D modelling with structural health surveillance?
- Does the implementation of SHM lead to an increase in project budgets?

By answering these questions, a sufficient basis is obtained to achieve the objective of this research, which is to:

Demonstrate the feasibility of a Building Information Modelling (BIM) integrated into geohazard monitoring tool for high-risk slopes and historic structures.

#### 1.4 Approach

Based on the issues raised, this research project is focused on two distinct areas of study; 1. Providing high resolution 3D object-oriented models and, 2. Real-time structural health monitoring. The aim of this research is to bring both of these methods together to generate a single information model.

First, a literature review is carried out to establish the current methods of 3D object-oriented modelling as well as various techniques for soil slope and retaining wall surveillance. (section3). Case studies displaying the use of structural health monitoring across different civil infrastructures; bridges, dams and megastructures. These examples highlight the relevance of structural health monitoring as well as show how sensors provide a means for accurate real time structural monitoring. From carrying out this review, it was seen that 3D object-oriented modelling has not been applied for the active surveillance of geostructures such as soil slopes but instead has been limited to civil structures during their construction. The various surveying methods were analysed to establish the optimal approach in slope and retaining wall surveying and continuous monitoring. Finally, the integration of this information into BIM was reviewed in order to approach the development of an early warning system in a structured manner.

In this project, two different methods of inspection, laser scanners and drones, is used and therefore, enables the contrasting of the information obtained. This allows an assessment to gauge if the chosen method is fit-for-purpose. Various factors such as their use and handling, quality of results and economic cost were considered to select an appropriate method.

Secondly, a visual inspection of the slopes and retaining walls is carried out (section 4). From this point, an order of priority is established for the study of the slopes or retaining walls. Furthermore, a review is also carried out of various studies previously carried out on the slopes, in order to establish what actions have been undertaken and what information on the slope/retaining wall is available for the present investigation.

The slope selected for detailed analysis is replicated through the use of a drone and a laser scanner. This enables a point cloud to be developed before a mesh of the slope surface can be formed. The resulting point clouds are compared and the higher quality result is used for the creation of the early warning system.

Thirdly, the structural health of the slopes is monitored. To do this, the results of the literature review are applied in the selection process of the sensors to be used. The slope monitoring study is carried out using Arduino Uno WiFi sensors, which have been specifically assembled and programmed for this study. In this way, the economic costs have been reduced, which will be evaluated later in the study. The sensors are applied to the soil slope most at risk for collapse and data is recorded over a period of time to assess for any slope surface changes and signs of instability. This data is then transferred to an online database in the form of Google sheet.

Lastly, and as the main goal of the research, to combine all the information collected to form a single 3D object-oriented model. To this end, it has been possible to connect the 3D modelling obtained through different methods with the monitoring of structural health. In other words, an early warning system can be created which, when the sensors located on the slopes exceed predefined values, the risk level of the slopes in the 3D object-oriented model by means of a colour scale will be identified. Thus, structural health monitoring is simplified by anticipating the actions on the slope by means of the early warning system.

## 1.5 Outline

Chapter 1 introduces the study topic and the motivation of research. From here, the research questions and the aims of the research are defined. Furthermore, an approach is formulated which distinguished the design steps to be followed.

In chapter 2 the fundamental theoretical background is presented. This also includes the background of Cobh and the site of study.

The literature review is summarised in chapter 3. This is where concepts such as structural health monitoring, slope inspection and BIM are defined. In addition, the different methods that currently exist to carry out slope inspection and different infrastructures are explained, as well as an economic study.

Chapter 4 details the methods used in the research. Therefore, it explains in detail how the different methods defined in the previous chapter have been carried out. To close the chapter, the economic cost.

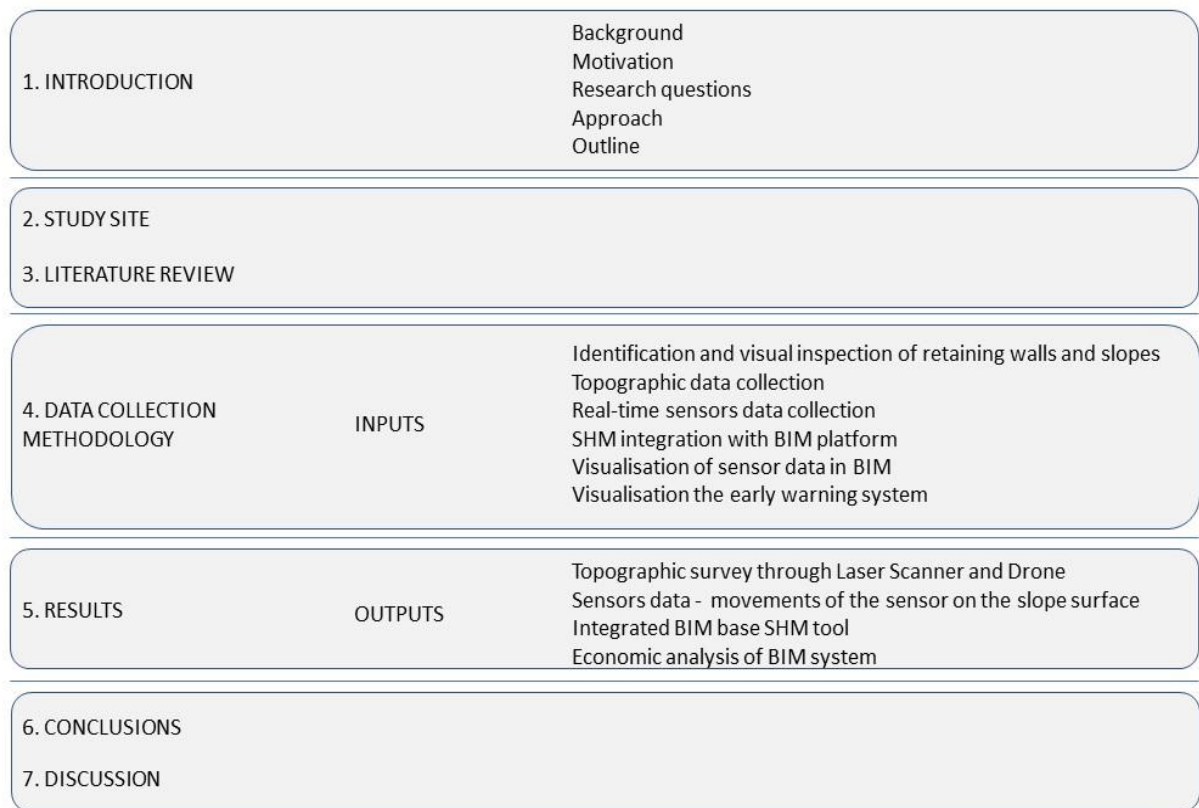

Figure 1. 3 Flow diagram highlighting the steps carried out to develop a GEOBIM SHM

## 2. Study Site

The town of Cobh is situated in the south of Ireland. It has a privileged location overlooking the entrance to Cork Harbour, which enabled the town to become a strategic and developmental point. However, the location of the town is on the side of a hill, which has a steep topography overlooking the sea.



*Figure 2. 1 Aerial view of Cobh highlighting the topography of the town (2)*

It was from 1800 onwards, due to the construction of the Haulbowline Naval Base, that the population of Cobh increased considerably, from hundreds of inhabitants to over 7000. Consequently, and due to the complexity of the topography of the terrain, retaining walls became very important. Built in masonry during the British rule of the island, the retaining walls have been under great stress due to the rapid growth of the town. Lack of monitoring of the condition of the walls, overloading, and weather all play a role in the structural health of these historic retaining walls. In the last 30 years, both rock falls and landslides on slopes have caused damage to property and even resulted in the loss of life of a child in 1980 (23).

In recent years, there has been the development of an unsafe embankment adjacent to a main road on Connolly Street that is used daily by heavy fishery lorries as well as refuse trucks and is a main road connecting the main town to a popular memorial garden. Located close to a site of a major 1997 landslide on East Hill, the Connolly Street slope has the potential to significantly impact the residents and business people of Cobh. With ongoing deterioration in its condition and extremely close proximity to the main road of Connolly Street, this unstable slope is an area of concern for many.

Cobh is a town that requires investment in both preventative measures as well as surveillance for the safety of the public. Such preventative works have already occurred in the town at a significant financial cost. In late 2009, Malachy Walsh and Co carried out a number of projects in the town such as new reinforced concrete wall construction, rock bolting, rockfall safety netting, reinforced shotcreting and repair of existing walls at five key sites in the locality to ensure the safety and stability of retaining walls, earth and rock slopes (24).



*Figure 2. 2 Shotcrete protection on a slope in Harbour Row, a slope previously at risk of collapse (3)*



*Figure 2. 3 Shotcrete protection on a slope at Saint Colman's Cathedral, previously at risk (3)*

Three such critical locations, East Hill, Harbour Road and Wolfe Tone Street, underwent extensive works which ensured the stability of the retaining walls and slopes. This was achieved through funding from the Department of the Environment, which provided €2.8 million, together with Cork County Council and Cork City Council, for a total amount of over €7 million for the rehabilitation and maintenance of the retaining walls at these critical points (23). On completion of the main works, approximately 200 other walls and slopes were not stabilised but identified for continuous monitoring as they presented risks which could eventually lead to collapse or damage if left unmonitored. It is these walls that form the subject matter of this research. A wall monitoring programming including visual and manual inspection on a quarterly basis was ongoing until 2016 however this has ceased, thus providing an ideal case study for wireless low cost SHM as presented in this study. On analysis of the cost of traditional surveillance techniques, traditional SHM costs an estimated €38,400 per annum, capital cost and over a ten-year period totals €384,000. In comparison it is estimated that the cost of a novel continuous monitoring system would be approximately €51,000 over a ten-year period with the majority of this originating in the first months, to establish the SHM system.

In this dissertation, a slope and retaining wall monitoring and surveillance study is carried out using various methodologies integrated in BIM. Firstly, a visual inspection of the current state of the different slopes and walls in the locality was carried out. After the visual inspection, it was decided to focus the study of the present investigation on one of the slopes located in Connolly Street, due to an active slope failure.



*Figure 2. 4 Landslide at the Connolly Street slope prior to any preventative measures (1)*

The main objective of the thesis is to provide a tool to monitor the structural health of retaining walls and slopes and to create an early warning system, using the Cobh locality as a case study. The tool will be used by asset owners, in this case the local authorities of Cork County Council, which will allow them to have up to date information on the structural condition of monitored retaining walls and slopes in real time.

The monitoring is based on a network of sensors distributed on the slope surface. This low-cost sensor network is made up of accelerometers that take readings of possible movements of the slope in real time. In this way, the monitoring costs currently incurred are considerably reduced. The information provided by the sensor network is integrated in BIM, which allows the visualisation of the state of health of the monitored infrastructures in a 3D object-oriented model in a simple manner and the creation of an early warning system, reducing intervention times and avoiding greater risks.

### 2.1 Geological setting

The geological strata that make up the terrain of the Cobh area are largely made up of three different sandstone strata:

- Sandstone with mudstone and siltstone
- Narrow sandstone layer with sandstone bedding and minor mudstone
- Sandstone with sand and mudstone bedding down to the shore of the harbour

The composition of the terrain, together with the cold and rainy climate of the area, has led to several landslide events in recent years. In early 1997, a landslide occurred in the

Fort Villas area, where the soil composition consisted of Courceyan mudstone and sandstone, causing serious damage to infrastructure. This was followed shortly afterwards in 1999 by the collapse of a retaining wall in the Easthill area, very close to Connolly Street, with the same geological composition as in Fort Villas (25).

Following the events in the locality, Cobh Town Council together with Cork County Council decided to implement the Development Plan 2009 in which a survey of those walls at risk was carried out to initiate a monitoring plan for control, follow-up and action.

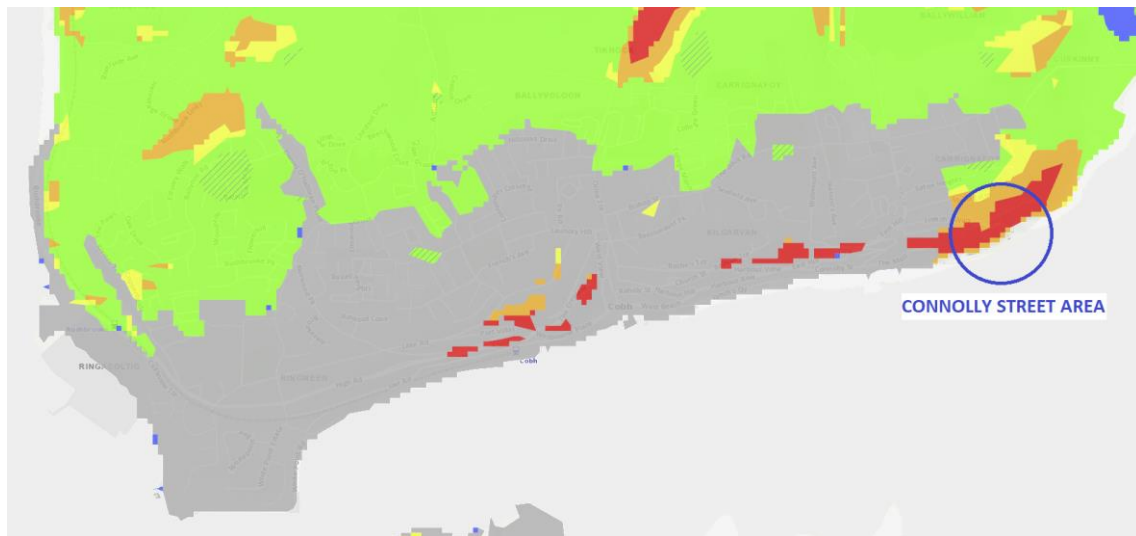

Figure 2. 5 GSI Classification of landslide susceptibility in the Cobh area (4)

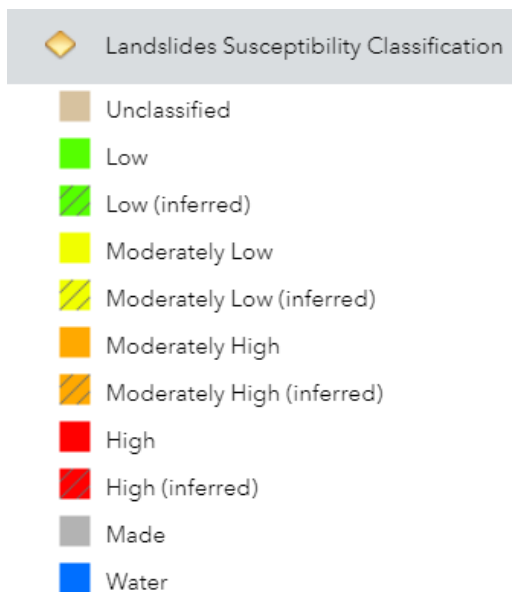

Figure 2. 6 GSI Classification of landslide susceptibility



A classification of landslide susceptibility in the Cobh area can be seen above. This shows that there are a large number of areas in the locality considered to be between moderately high and high risk for landslides.

Based on the topography of Cobh town along with the large number of retaining walls and soil slopes, Cobh was considered to be a suitable location for the development and application of a novel early warning system. The town has already undergone a number of previous restoration and preservation works at a large cost and so it was intended to develop a more cost effective system for the surveillance of retaining walls and soil slopes at risk in the surrounding area (5).

### 3. Literature review

Civil infrastructure provides the means for today's society to function, including various types of buildings, bridges, tunnels, power and nuclear power plants, foundations and excavations (26). Hence the importance today of analysing the state of preservation of all types of infrastructure for optimal maintenance and proper structural performance as well as safety.

Since the middle of the 20<sup>th</sup> century, various methods of structural health monitoring (SHM) have been in use and are still active and working well today (26). In recent years, the different methods used have evolved by incorporating and developing important improvements in order to provide comprehensive coverage, analysis and reporting on the status of the monitored infrastructures/assets. Consequently, structural health monitoring systems are now focused on digital systems, given the quality of the results obtained and the speed with which they can be obtained. At the same time, another point that has favoured the increase in structural health monitoring is the reduction of economic costs. Thus, it is an aspect that has been especially taken into account, since it not only translates into cost savings, but also allows for greater investment in safety issues, becoming a potential factor in current projects involving structural health monitoring (27). Within this framework, companies are investing more study time and various resources in structural health monitoring of infrastructure and slopes, making SHM a key transcendental component in structural health monitoring projects (28).

Structural health studies aim to provide a diagnosis of the state of the structure as a whole, i.e. over its lifetime. Over time, every structure undergoes natural deterioration due to various factors such as climatic impact, use or even damage caused by accidents (27). For this reason, structural health monitoring aims to detect damage to infrastructure in its early stages, and consequently provide a solution to prevent further structural health complications. The aim is to clarify as much as possible the definition of the damage caused, which implies any change in the material properties and geometry of the infrastructure, and which may negatively affect the current and future structural behaviour of the infrastructure (28). While it is true that not every type of damage caused to structures implies that it is necessarily irreversible, i.e. loss of

functionality of the system, but rather that the damaged structure will cease to function optimally and with a negative progression (28). This is why it is important to define persistent damage to infrastructure in the early stages of structural monitoring. However, it must be emphasised that structural health surveillance puts the safety of people before the use of the infrastructure.

The implementation of SHM in a project must start from a visibly planned objective. To do this, it is necessary to know in advance what types of structures are to be studied and to score the damage to the infrastructure. Once this has been done, it is advisable to be aware of the different methods that currently exist for structural health monitoring, in order to optimise their use and results, in addition to avoiding a loss of traceability in the study and also, increasing the economic costs.

The field of study for the implementation of SHM is becoming wider and wider, allowing the current state of different infrastructures to be known in real time. Below are several studies from different fields that use structural health monitoring for structural surveillance. Of note, SHM does not always imply that there is damage to the infrastructure, i.e. the implementation of SHM involves structural health monitoring, providing a report on the current state which, in the event of real damage, SHM will be adapted to refine and purify the information obtained and provide an optimal solution. Conversely, if there is no damage to the infrastructure, the SHM will serve as an early warning system and, ultimately, an optimal real-time monitoring that will prevent future damage.

Within structural health monitoring studies, one must consider several factors such as the importance of its use, the risk of collapse and the danger to the public. All of these factors are necessary for proper inspection, surveillance and maintenance of the infrastructure (26). Similarly, other external factors that put structural health at risk must be noted in the case of landslides. Nowadays, landslides have become an area of concern for geotechnical engineering, as heavy rainfall following long dry spells alter the geological properties of slopes causing large internal cracks (29). Because of this, it is particularly well known that being able to detect in advance any kind of anomaly in a landslide affected by rainfall is a more complex task than when the landslide is due to other causes, such as its use, vegetation or natural movements of the ground (30).

### 3.1 Structural health monitoring (SHM)

Construction has grown exponentially in the last number of decades, and with it, new ways of building and the use of new materials, allowing for a significant improvement in the conservation of infrastructures over time (31). In this same context, one of the main keys to the current state of infrastructures is the use of construction materials such as concrete, which opened a new era in civil engineering, allowing the construction of buildings and infrastructures in a much faster, safer and more durable way over time.

Due to the condition monitoring of structures, various structures can be measured, inspected and evaluated in an up-to-date and cost-effective way (32). Thus, it is considered that the structural performance of infrastructures can be assessed through a continuous monitoring process, focusing solely on the deformation properties of the structures. Therefore, the monitoring of structures through SHM allows asset owners to be informed about the continuous changes, whether gradual or sudden, in the structures (26). Ultimately, the main objective pursued by the vast majority of industries is to be able to detect damage to infrastructure in time. To this end, extensive research has been carried out in recent years for new techniques to provide various information on the state of infrastructures. However, no system for real-time continuous data acquisition represented on a 3-D object-oriented model has been developed.

The Internet of Things, structural health monitoring and smart structures are terms that are increasingly being used in project studies. Thus, these concepts are responsible for new searches for technologies for structural damage detection. In addition, another key research challenge is the use of new technologies to facilitate the data processing algorithm (31). Therefore, structural health monitoring is at a crucial point of growth and development.

The exploitation of SHM systems is not limited to civil engineering infrastructures. It extends to a wide range of projects and studies. To exemplify the above, aerospace companies, together with government agencies, are investigating the use of various SHM technologies, in order to categorise damage to the special shuttle control surface that is hidden by heat shields on vehicles designed for outer space (28).

Another example where SHM facing a development challenge is in the monitoring of buildings after an earthquake. At present, there are no technologies available to assess the structural health of a building after an earthquake, which would minimise the uncertainty associated with this type of assessment (28). For this reason, researchers aim to develop a SHM system that facilitates and speeds up this type of inspection.

For the calculation of slope stability there currently are a large number of tools that facilitate the analysis. One such software is 'Slide', which allows a 2D analysis of slope stability. This is done using the limit equilibrium method. The limit equilibrium method is one of the most commonly used methods of slope stability analysis whereby potential failure mechanisms are identified and factors of safety are obtained (33). In addition, it includes steady-state finite element groundwater analysis, and integrates sensitivity and retrospective analysis capabilities where the horizontal and vertical components of forces are calculated (34).

A software also commonly used is Plaxis (4), which through the modelling of the slope and the application of numerical methods and novel computational solutions, allows for the study of the behaviour of the slope and the effects on stabilisation as the various factors that come into play in its stability vary. As with the aforementioned software, Plaxis allows finite element analysis including deformation, stability and water flow. In addition, and thanks to the evolution of technology, Plaxis has re-launched a 3D version, which allows a modelling of the slope and an improved visualisation of how the parameters affect the stability.

The Plaxis analysis results are of very high quality, however, the 3D modelling is an estimation of the slope and is therefore far from reality at times and does not allow the slope to be seen in detail. Using a 3D visualisation tool that allows for a detailed view of any anomalies on the slope surface facilitates the understanding of pathologies and diagnosis of the structural behaviour of the slope.

Secondly, these analyses and calculations carried out to date on the structural behaviour of the slopes do not provide an evolution of this behaviour over time, but are rather one-off analyses. Through these limitation in the Plaxis software, this thesis proposes to

develop a method of predicting the structural integrity of the slope via real-time slope surface surveillance in collaboration with 3-D orientated models.

Although SHM is well established and its use integral to structural maintenance, the need for a real-time 3 D object-oriented model early warning system is highlighted with no current process established. Integration of multiple sources of information on structural health into one system would allow for more detailed surveillance whilst structural changes identified earlier and more accurately.

### 3.1.1 SHM case studies

Before implementing structural health surveillance, it is necessary to consider minimum requirements. These are not minimum technical requirements, but characteristics that must be fulfilled in order to achieve sustainable and consistent structural health monitoring. Therefore, structural health monitoring must meet the "AtoE" characteristic, i.e. accuracy, benefit, completeness, durability and ease of operation, in the design of a long-term reliable structural health monitoring system (32).

Furthermore, as it states (35) it would first be necessary to identify which infrastructures are suitable for structural monitoring, e.g.

- Any modification or change to an existing infrastructure.
- Structures affected by external works
- Fatigue assessment
- New construction systems
- Demolition
- Comprehensive post-earthquake assessment
- Structures subject to movement and/or degradation of materials.

Another classification to consider when monitoring structural health is that there are two types of structural health damage, linear and non-linear. When the structure suffers damage, but does not lose its elastic properties and can therefore continue to be used in a normal way, this is linear damage. However, when we speak of non-linear damage, the equations representing the movement of the structure change radically, because of a typical response of the structure (36).

There are currently a multitude of projects where studies have been carried out through structural health monitoring. The following are some examples of projects where, thanks to structural monitoring, it has been possible to determine an effective action project.

#### *3.1.1.1 Structural health study of long-span bridges in the United States;*

In the United States, more than 600,000 bridges are inspected once every two years to proactively manage the structural health of bridges by proactively (37) i.e. by diagnosing damage and facilitating an optimal and effective response to operational incidents, natural hazards and other emergencies.

The way to rate the structural health of bridges in the United States is through a rating scale defined by the Federal Highway Administration. This rating starts from a score of 0 for a defective condition to a maximum of 9 for a new bridge. However, these ratings only take into account the structure as it was built at the time, without considering the deterioration of its load-bearing capacity (37). The first step in the early detection of structural health is a visual inspection, which reveals the current state of deterioration of the structure and how this is affected over time (37). The problem with this type of inspection is the high cost of execution for long bridges. For example, the two inspections carried out on the Brooklyn Bridge in New York take more than 3 months and cost more than one million dollars (38). However, according to the FHWA (Federal Highway Administration), the results of these inspections were not very reliable. The US researchers concluded that by monitoring bridge structures with sensors and diagnostic algorithms, the results were more accurate once the data was processed. In addition, data collection was faster and less expensive, making it possible to increase the number of bridges to be studied in a shorter period of time.

This method of classifying the structural health of infrastructures allows an initial assessment of their current state in a visual, quick and simple manner. This classification and visual inspection technique is carried out in the structural health monitoring study of the slopes and retaining walls located in Cobh and the object of study of this project. First of all, a visual inspection is carried out to identify the possible damage caused in the accessible points of the slopes and walls. Once they have been marked and identified, a brief classification is made, which may be numerical, to establish an order

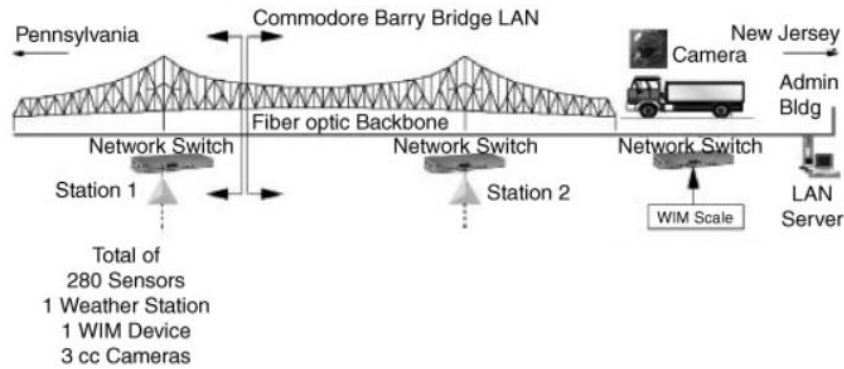

Figure 3. 2 Monitoring over the Commodore Barry Bridge, USA (5)

of priority for action, with those with the highest level of damage at the top of the list and, therefore, those at greatest risk. This brief classification will help to speed up the process of action on the slopes of certain and coherent slopes.

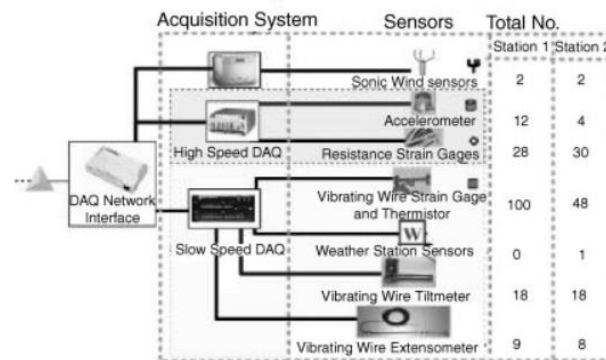

Figure 3. 1 Sensor network layout on the Commodore Barry Bridge, USA (5)

### 3.1.1.2 Study of earthquakes using structural health monitoring systems in dams;

The evaluation of the behaviour of dams under different parameters such as operational vibrations, changes due to environmental effects and seismic movements has been a clear study objective to be carried out by the International Commission on Large Dams (ICOLD)(39). The result of such studies provides a database on the current state of the dam structure, the possible seismic response and the dynamic behaviour over time. This study has been carried out on hundreds of dams around the world, such as the Cahora Bassa dam (Mozambique) or the Pacoima dam (USA). The results from both dams were accurate and valid for engineers and researchers to use finite model calculations to characterise the dynamic response to seismic vibrations, natural frequencies and the response of the structure to modal damping (39).



A clear example of the use of structural health monitoring in dams can be found in Portugal, where the National Laboratory of Civil Engineering (LNEC) and Portugal's largest electricity company, EDP, have made a strong commitment to the use of SHM for monitoring and studies in the country's water dams. Thus, the Cabril dam, located on the Cecere river, 136 metres high and one of the largest freshwater reservoirs in the country, was the subject of a study using SHM. This provided parameters of the dam's behaviour in the event of vibrations and seismic events. The technology used here has been extended to many other dams in the country today, due to the quality of the results obtained. The system used to monitor the dams was through sensors, accelerometers that work in continuous time and in an automated way (39). Through an external server and routers, the survey data were obtained remotely in real time. The data were then fed into finite model software for data processing. The information obtained can be classified into the following points;

- Changes in modal parameters over time, according to variations in reservoir water level and thermal variations.
- Structural changes due to deterioration of materials over time.
- Analyse existing seismic vibrations in the structure.
- To make a comparison of the structural effects caused by seismic events against a reference model without damage. The aim is to analyse how cracks are produced and how they behave in the presence of environmental vibrations.

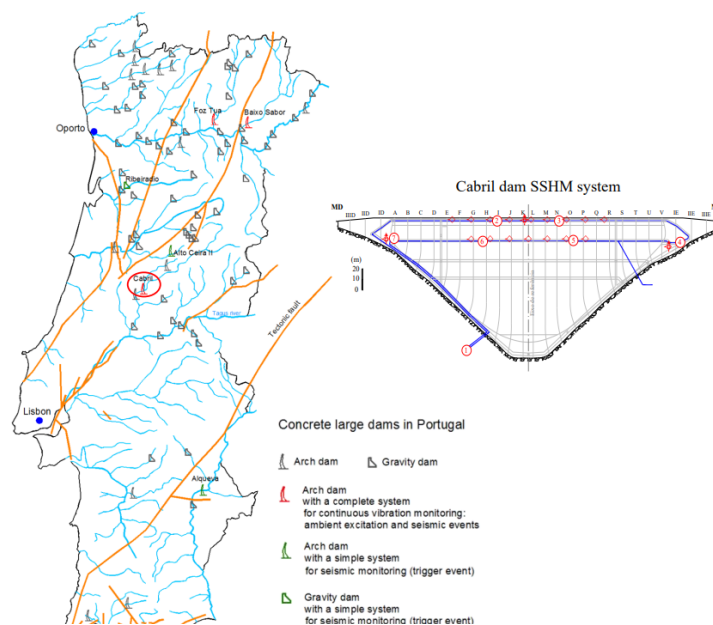

Figure 3. 3 Sensor monitoring at Cabril Dam, Portugal (6)

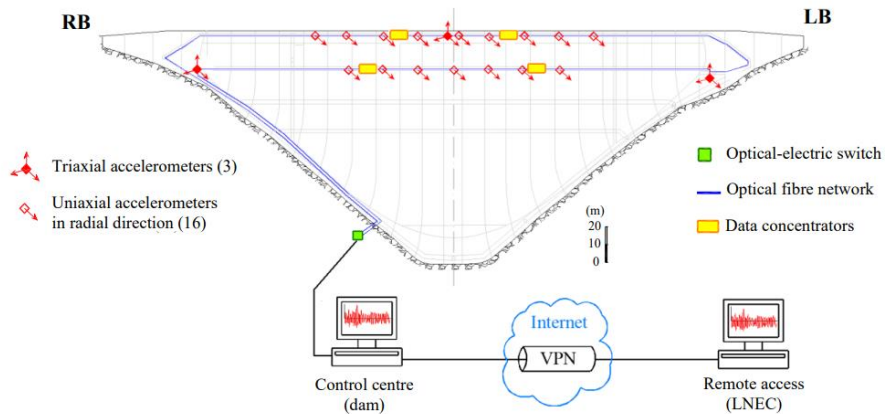

Figure 3. 4 Sensor deployment at Cabril Dam, Portugal (6)

### 3.1.1.3 SHM in megastructures

The silhouette of large cities is based on large skyscrapers. Mega-structures subjected to multiple factors that test their resistance. Seismic events, environmental vibrations, soil-structure interaction and climatic effects such as wind are the main objects of study in this type of building (40). Visual inspection is an arduous but necessary task, where the evolution of the structure over time is observed. But in these buildings, visual inspection becomes an impossible task, with high personnel and economic costs. This is when the implementation of structural health monitoring systems plays a very important role in these buildings.

The new television tower in Guangzhou, China, is a clear example of exemplary monitoring of the structural health of the tower. It is a tubular structure 610 metres high. It consists of an inner reinforced concrete tube and an outer steel tube connected to concrete columns. The main use of the tower is for broadcasting the television signal, but it is also used for offices, restaurants and sightseeing because of its height, with panoramic views of the city (41).

The way in which the monitoring of the tower superstructure has been carried out is by implementing a monitoring system based on 800 sensors for real-time monitoring. The system was implemented in the structure during its construction, so it has been able to provide data on the structural behaviour from the early stages of construction (40). The results obtained allow engineers to work with analytical and experimental models of the tower, measuring the environmental vibration parameters, the structural response to climatic agents such as typhoons and earthquakes, against the values obtained in a finite element model, in order to obtain a reference model for monitoring and anticipating damage to the structure, as well as to check the effectiveness of the operation of the different vibration control devices placed on the structure (40).

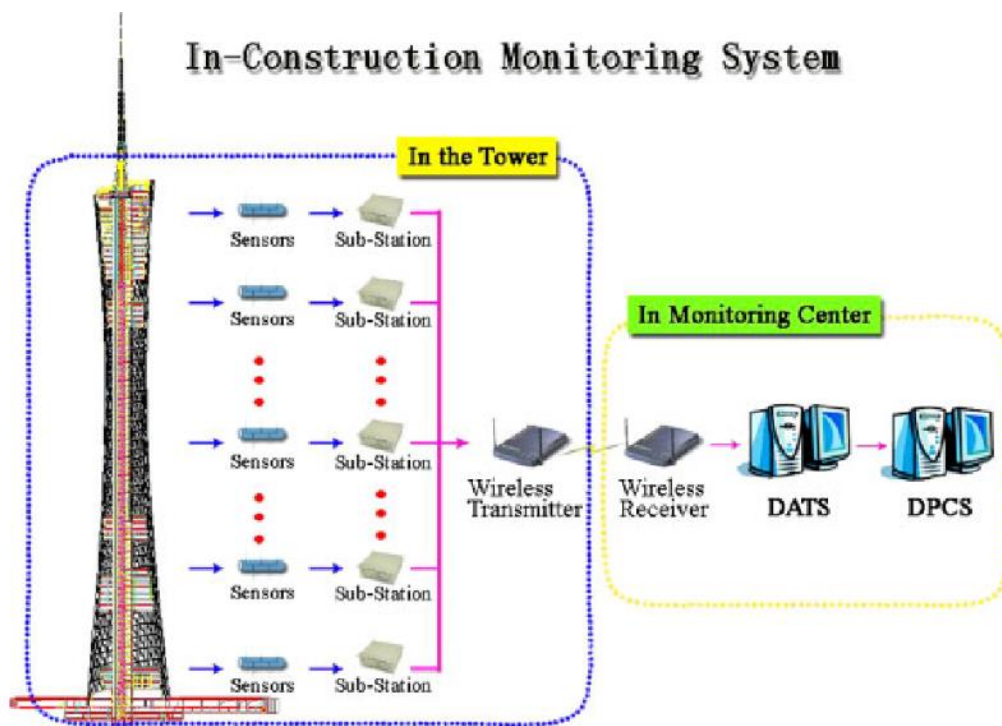

Figure 3. 5 Sensor monitoring at Guangzhou TV tower, China (7)

Similarly, in Turkey, a country subject to major seismic movements, numerous structural health studies are carried out given the deterioration suffered by structures in the country. For this reason, since 2019, SHM systems have been mandatory in large buildings in Turkey, allowing engineers and researchers to know the structural behaviour before, during and after an earthquake, in an optical, precise and objective manner (42).

In conclusion, the use of SHM extends beyond a single structure. SHM systems are part of the project development of any structure and are envisaged from the early stages of construction, in order to avoid potential catastrophes and to anticipate mainly any weather-related havoc.

The degree to which structural health monitoring is required will always depend on the damage to the infrastructure and the data required for its design. From the evidence obtained in the exposed projects of the dams in Portugal and the skyscrapers in Guangzhou, it has been possible to verify how, through sensors, all the required information on the infrastructure is obtained, not only to know its current state but also to predict the behaviour of the infrastructure both with the passage of time and in the event of specific events.

Structural health monitoring applied to geotechnical systems is still remained an area to be developed. There is a lack of knowledge surrounding this area of study. However, there is evidence of projects currently being carried out in which, through the use of sensors, the behaviour of this type of structure has been studied. In the case of the reinforced concrete retaining wall that forms part of the new Student House at the University of Molise, Italy (43), the dynamic behaviour of the structure was studied throughout its useful life since construction by means of piezometric sensors embedded in the piles. In addition, with the use of accelerometers placed in the walls of the building next to the Student House, it was possible to evaluate how the retaining wall interacted with the structures of the adjacent building.

Therefore, a multitude of sensor types are available for structural health monitoring, which provide highly accurate information. The choice of the type of sensor to be used in the project depends on what factors are to be evaluated and what information is required. In this thesis, studying the slope at Connolly Street, the evaluation has been carried out using an accelerometer and gyroscope sensor. The aim of the project was to evaluate any possible movement on the slope surface. For this reason, this type of sensor fulfilled the expectations of the project, as well as being easy to use and inexpensive.

### 3.2 Different methodologies

Using current surveillance and monitoring, the cost to carry out a single analysis is significant with a lengthy amount of time required to complete a full analysis. Current methods call for quarterly surveillance of at-risk slopes and retaining walls. Through this process, it can be estimated that a laser scanner would take approximately two hours per wall. Through the works of Malachy and Walsh (6) a total of 24 high risk structures were identified in Cobh town and area. If only these high-risk structures were chosen for surveillance, this would mean an estimated 60 hours to scan the structures in total prior to the analyses of the images. This process requires repeated scans and would be done a minimum of four analyses each year. In total, with the laser scanner costing approximately €1700-€2000 per week as well as the cost of employment and the number of walls to be scanned and analysed, the annual cost is approximately €40,000.

Furthermore, as this process is only carried out quarterly, the results only provide interval data with significant time between each data collection point. The possibility of structural damage or changes occurring during this interval is high. The amount of damage that could have occurred during these analyses could vary according to the seasons or use of the structures and so the level of damage may vary. With this varied rate of damage, the restorative measures required could increase dramatically. Through early identification of at-risk areas in a structure, preventative measures can then be implemented to prevent further deterioration and therefore be cost saving.

#### 3.2.1 Geodetic methods

Geodesy is one of the oldest sciences, and its main focus is the shape and dimension of the earth, considering gravity and its temporal variations. Geodesy is a science based on physical and mathematical foundations and is used in practices such as surveying, mapping, photogrammetry, navigation and engineering (44).

The monitoring of the structural health of bridges is mostly done by geodetic methods, as the geometry of the bridge prevents or makes it very difficult to monitor it by sensors (45). Therefore, in order to avoid possible catastrophes in this type of infrastructure, and due to the reliability and stability of their results, the use of geodetic systems for the study of deformations and the monitoring of structures is becoming increasingly common (46).

One method that has the potential to be very accurate in its results is the acquisition of satellite data for slope monitoring. These are capable of providing high resolution data. These are very high-quality photographs which, when processed correctly through appropriate software, allow damage to the infrastructure surface to be analysed with millimetre accuracy. They are widely used to study natural hazards. On slopes, for example, one of the first signs of a landslide are cracks in the original slope surface. These cracks evolve into a main scarp in the area of the landslide (47). Thanks to satellites and the information they provide, such as rainfall data, very precise studies can be carried out to help prevent rain-induced landslides (48). The information collected by satellites is reliable, accurate and continuously updated. It is easy to collect and makes it possible to observe the deterioration of infrastructures over time. In addition, it allows the first study steps to be taken in the project, as all the information provided by the satellites is currently collected and it is not necessary to make an on-site visit to the slopes under study or to the retaining walls.

To avoid human and material losses, high priority is being given to techniques that work in real time, thus providing the necessary information for the study on a continuous basis.

It is thanks to technological advances, accuracy, automation and data processing that have made the geodetic method one of the first steps in structural health monitoring. At the same time, remote sensing is another of the most widely used processes in structural health monitoring. In the following, the different measurement techniques are briefly summarised;

- ADM (Areal Deformation Measurement)
- Terrestrial laser scanning
- Terrestrial SAR (Synthetic Aperture Radar)
- LiDAR

The SAR is mainly composed of a transmitter, a receiver, an antenna and a system that will facilitate the data storage process and finally a system to process the data. It is a very practical and easy-to-interpret system, as the information it returns is a reflectivity map of the area it illuminates. Depending on the reflected signal, the system can

eliminate objects that are not within the study area. Objects that return more signal to the radar would appear as bright spots in the image. Although it is one of the most widely used methods, it has a disadvantage to be taken into account, as the interpretation and processing of the data is somewhat complex (49).

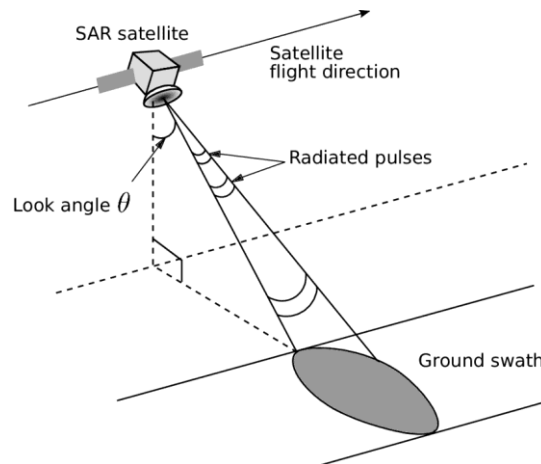

Figure 3. 6 Principle of operation of Synthetic Aperture Radar (8)

While LiDAR is a high-precision technique, it uses electromagnetic radiation to calculate the distance from the optical centre of the instrument itself to a reflecting surface (50). The application of this technique, used from a ground-based platform, provides very detailed information on steep slopes. To obtain more accurate measurement results, shorter ranges should be considered, as well as a brief study of the location of the instrument to try to make it as static as possible (51).

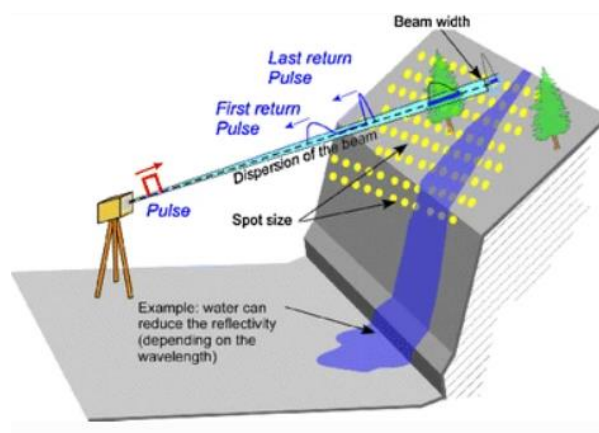

Figure 3. 7 Principle of LiDAR operation (9)

### 3.2.2 Geotechnical methods

Slope monitoring by geotechnical methods is one of the most effective methods to prevent landslides in time or, in the worst case, to reduce them (52). In order to carry out such a study, it is necessary to perform field measurements on slopes and hillsides that are considered unstable or at high risk of becoming unstable, with appropriate instrumentation and equipment, resulting in effective and accurate monitoring.

The vast majority of the measurements carried out in geotechnical methodology are field measurements, i.e. they are carried out in situ by appropriate and qualified personnel. Although there is instrumentation that works in an automated way, currently and more specifically in the study of slope stability, these instruments are still used for their quality, ease of reading and data processing.

Geotechnical instrumentation for measuring slope deformation;

There are many types of geotechnical instrumentation, but when considering slopes, as is the object of study of the present project, a specific field instrumentation is required to obtain mainly the following points, as established by Aldo Oliva Gonzalez (53);

- Horizontal and vertical movements
- Cracks in the ground
- Acting forces
- Pressures and water levels
- Effects of earthquakes, impacts and vibrations.
- Internal water flow characteristics of the slope
- Measurement of mechanical properties

The instrumentation used to obtain the above parameters includes extensometers, inclinometers and piezometers.



### 3.2.2.1 Extensometers

It is mainly used to measure displacements between points, and this can be done by means of a rope extensometer, which is based on a uniaxial displacement capable of measuring the length variation between two bolts anchored in the floor (53). It is used for measurements on the ground surface to monitor the existing displacement and the evolution of cracks over time. This type of instrumentation is equipped with a digital readout, which can also be stored in a data logger and transferred to a computer (52).



Figure 3. 8 Extensometer in action (10)

For small cracks in walls, smaller extensometers are available which can measure with an accuracy of  $\pm 0,01$  mm the crack opening. They can be digital readout extensometers, equipped with sensors inside that measure the linear displacement. Likewise, they can be biaxial or uniaxial measuring extensometers, depending on the information to be obtained and the demand of the project.

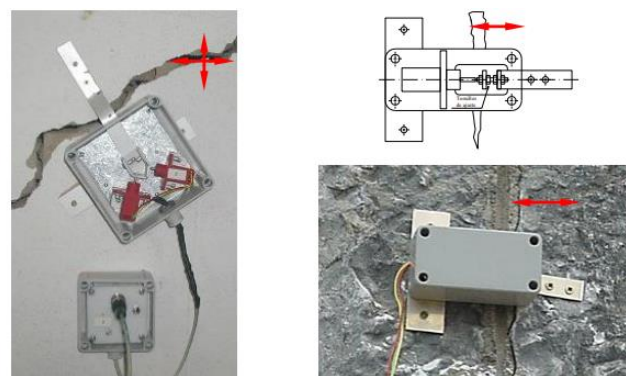

Figure 3. 9 Small Crack Extensometers monitoring cracks (10)

Finally, there is a type of extensometers that are better known as strain gauges, which are able to measure the deformations in the longitudinal direction of a borehole, which allows to know the vertical movements of the ground or slope (53).

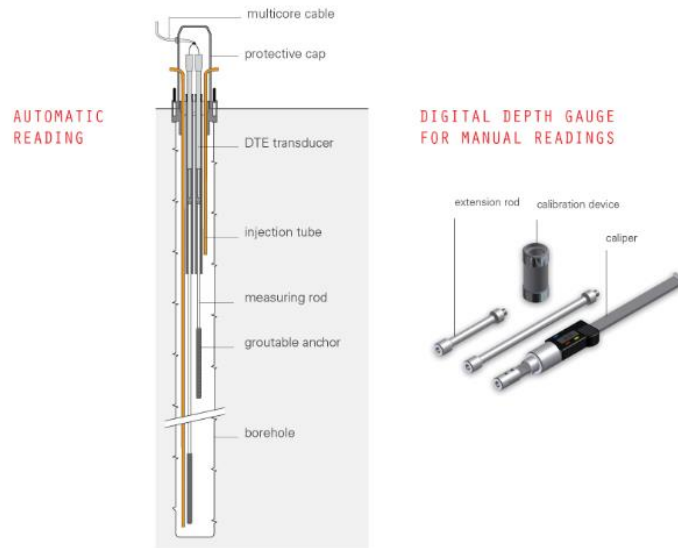

Figure 3. 10 Mechanism of extensometers for vertical movements (10)

### 3.2.2.2 Inclinometers

Slope inclinometers are used to determine the magnitude, direction, depth and type of landslide movement (54). The electrical probe which forms the main part of the inclinometer is usually lowered through a guide casing to the base of the borehole. On reaching almost to the bottom, when the electric probe starts to rise, and in the meantime, it provides the inclination in two orthogonal planes at certain, previously marked intervals (52). The results obtained are profiles of the borehole in the planes, by means of a series of points. Basically, it is a measurement obtained through different responses generated after the behaviour of a pendulum acting by gravity (55).

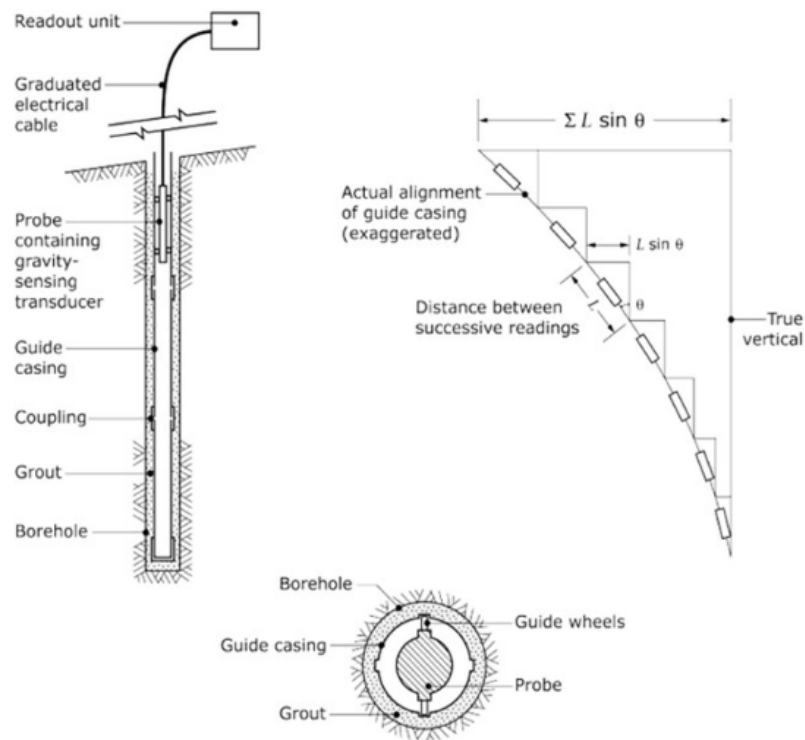

Figure 3. 11 Mechanism of action for an Inclinometer (10)

### 3.2.2.3 Piezometers

The piezometer measures the pressure load of the water at a chosen point in the ground or on the slope. The great majority of piezometers work with a kind of back pressure, in order to obtain the pressure exerted by the water inside the ground on a sensitive unit (53). They are used in an open standpipe, but the standpipe is completely sealed in the backfilled embankment, or can simply be driven into the ground (52).

The principle of operation of the piezometer is based on a pressure gauge, which can be electric, hydraulic or mechanical.

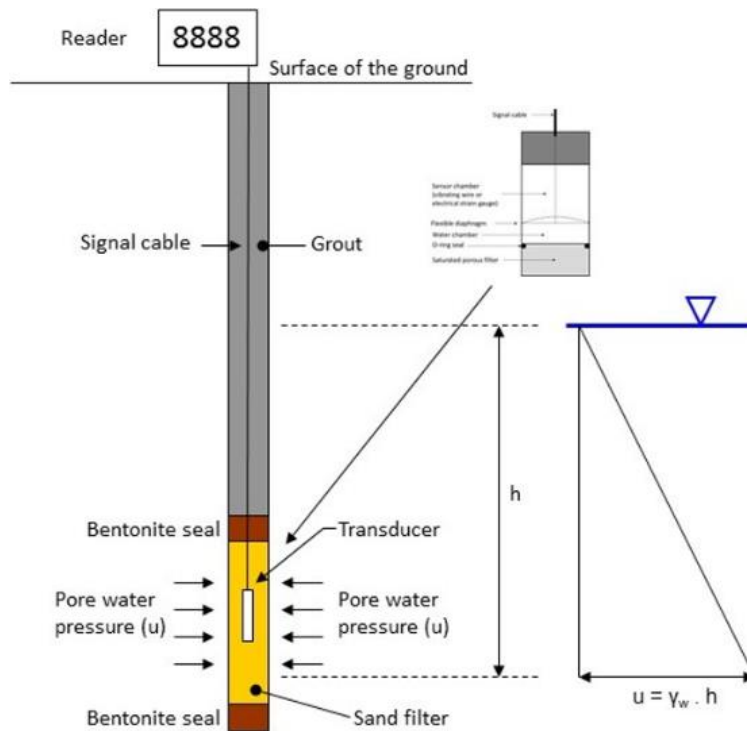

Figure 3. 12 Mechanism of action of Piezometer (11)

### 3.2.3 Geophysical methods

The evaluation of the different geotechnical conditions of a soil or slope as a base for the foundation of a future civil structure can be carried out by means of different methodologies. One of these types of methodology is through geophysical techniques, such as vertical electrical soundings, which allow to perfectly recognise the conditions of the subsoil and its properties.

The advantage of this method is the speed with which the inspection data is transmitted and, at the same time, it does not entail a high economic cost for the project. This is one of the reasons why this technique is widely used in many projects in which the characteristics of the terrain are to be evaluated in terms of its physical magnitudes. It should be borne in mind that this methodology is considered complementary to other methodologies. It must be accompanied by complementary information to provide real and effective values.

Geophysical methods can be classified into the following categories:

- Gravimetric methods
- Electrical methods
- Seismic methods
- Magnetic methods

When monitoring spatial and temporal temperature distributions, geophysical techniques are commonly used to monitor geothermal systems. The current use of the methodology in this application is based on being able to provide an optimal design of the geothermal system and the monitoring network, prevent possible thermal feedbacks and thermal recycling and, finally, thermally control the study area in a much more visual and intuitive way (56).

In particular, the study of soil and slope stabilisation is carried out with long-term projects, where the key point is to be able to study and evaluate how and in what way the different characteristics and properties of the terrain evolve (57). For this reason, continuous monitoring and high-quality results are required. Therefore, it is here where geophysical methods have a high presence in the projects. As it is an indirect methodology, it provides the quality of results required in this type of project and a low cost of execution. In addition, another point in its favour is that it is a non-invasive methodology.

Another field in which the use of geophysical techniques is very common is the hydrological study of the terrain. The study carried out by Robinson et al (58) shows that important advances can be made between geophysics and hydrology. In addition, the article highlights the instrumentation used for the measurement of geological structure and, in turn, the identification of flow paths using two different geophysical techniques, an electrical and a magnetic technique. The study demonstrates that both techniques could revolutionise the hydrogeological interpretation of the terrain. In addition, the use of the electromagnetic methodology and the clarity of its results, allows a visual interpretation with a 3D terrain model that makes the interpretation of the results of the study much simpler and visual.

The purpose of this research project does not require the use of geophysical methodology. No invasive geotechnical method is applied on the slope, so the geophysical methodology, although well regarded for the quality of the results it provides, has not been considered for this research project. The objective was to minimise the geotechnical impact on the slope, as well as a considerable reduction in the economic cost.

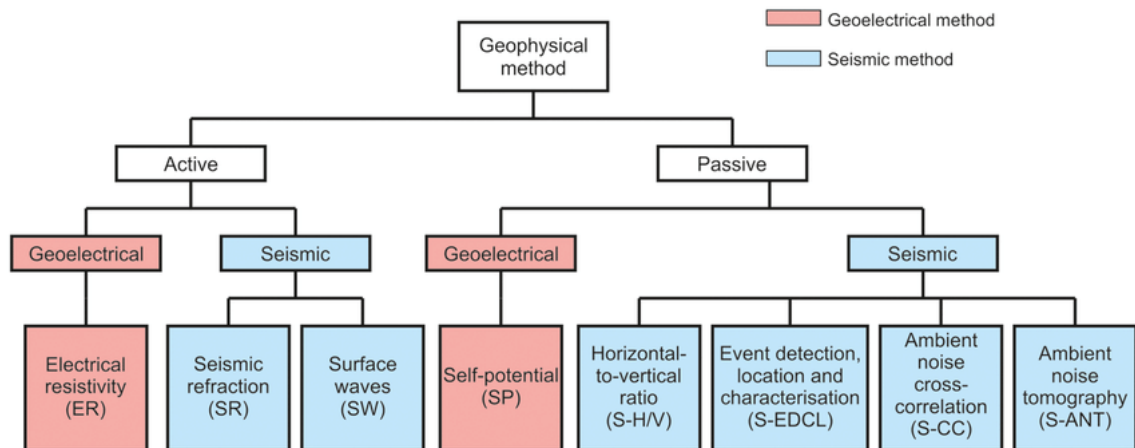

Figure 3. 13 Diagram of potential geophysical methods of surveillance (12)

### 3.2.4 Remote sensing

Remote sensing is today's fastest growing ground data acquisition methodology. Since the basic principle of data acquisition is through sensors, and therefore in full development due to the rapid and constant evolution of sensors, remote sensing is today the most effective technique in obtaining data through electromagnetic interaction between the ground and the sensor.

In particular, remote sensing provides a data set that covers the area of the existing soil or terrain under surveillance. As explained by Mulder (59) the set of remotely sensed results can be processed in several ways. Firstly, it allows the landscape to be divided into homogeneous soil portions, on which classical methods can be used to perform composition assessment and classification studies. Secondly, all remotely sensed data can be analysed by physical or empirical methods, which allows the different properties of the terrain to be understood.

The study of the behaviour of the slope in this study will be carried out by means of sensors. These will be placed at different points on the slope and will change position

every so often. The aim is to be able to study the behaviour of the slope at different points at certain time intervals. It will be the data obtained from the triaxial sensors that will determine the surface movement that the slope may undergo. In recent years, the use of sensors and, at the same time, the development of different software that provide images of the movement of the sensors, is a growing application (60). Therefore, all this development and evolution in the use of sensors in remote sensing, favours the use of photogrammetry. Due to the demand and requirement for information on the current state of the ground, stability and behaviour over time, the quality of the projects is very exhaustive with the results obtained.

Regarding the different methodologies used in remote sensing, first of all, it is necessary to know what information it is going to provide and its data processing. In the study of a rock massif by remote sensing carried out by Stead et al (61). In the study of a rock massif by remote sensing, we can observe the classification of the different typologies that exist in the study of the terrain with remote sensing.

- Digital photogrammetry; study of the terrain through digital photogrammetry, which gives access to the creation of a 3D model, through high-resolution photographs taken from different points. It is through a semi-automated procedure where a pairing of pixels is produced within the photograph resulting in the study scene. This type of photography is usually carried out using drones equipped with high-resolution cameras.
- Laser scanning techniques; a representation of the slope is obtained in a point cloud. It is based on a laser pulse emitted by the instrument that reaches the slope and is reflected by the instrument. Nowadays there are different computer programmes that help to process the data obtained, which allow the images obtained to be refined and thus facilitate the required structural analysis.
- IRT studies; which are based on knowledge of the temperature distribution.
- HSI studies; allows the electromagnetic radiation reflected from the object of study to be known.

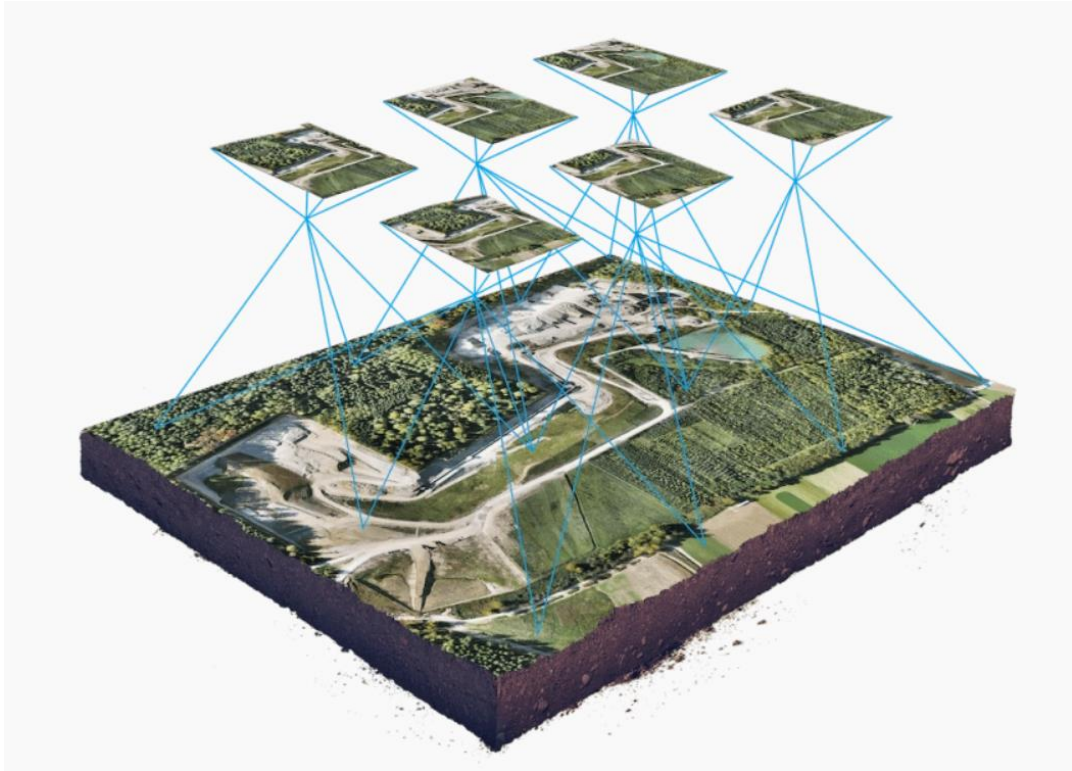

Figure 3. 14 Principle of operation of photogrammetry (13)

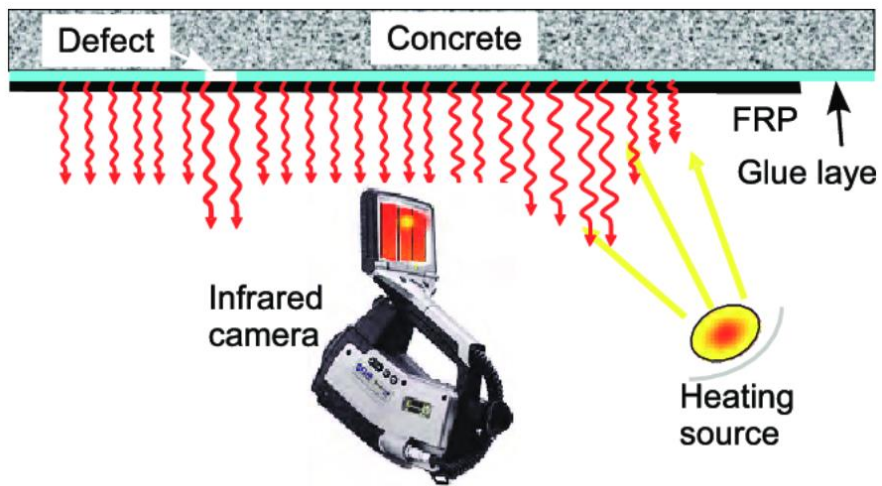

Figure 3. 15 Infrared Camera Operating Principle (14)



### 3.3 Slope inspection

The constant growth of public transport and the demand associated with the construction of new road networks leads to natural cuts in slopes (62). As a result, the properties of the slope structure change. To prevent slope collapse, a slope condition survey is carried out to ensure the stability of the structure.

Depending on the geometry and location of the slopes, slope inspection can be an arduous task. Normally, inspection personnel take measurements of the fractures to which they have access, check crack gauges and take photographs. However, sometimes it is impossible to access the study area, so it is impossible to inspect the slope and a full assessment of the damage cannot be made. As a result, a multitude of different methodologies are now available to facilitate the inspection process. During this research project, different inspection methodologies have been implemented that demonstrate the quality of the results obtained, ease of use, time saving and without endangering the inspection personnel.

#### 3.3.1 Routine visual inspections

One of the main tasks within slope monitoring is the routine visual inspection, which allows us to know retrospectively how the slopes are evolving, and in our case, how they are going to evolve.

In recent times, the investigation of slope stability has become one of the most important debates in environmental engineering. The stability of slopes depends on multiple factors that put their structure at risk. These are factors such as the height of the slope, the angle of the existing discontinuity or fracture plane, the degree of topographic slope, as well as the physical and mechanical properties of the slope (63).

The existence of fractures or collapses in the slope raises the conservation problems of the slope to a high risk, putting at risk the conservation of roads, buildings near the slope and the prevention of catastrophes. Moreover, the collapse of a slope is marked by a progressive internal cracking of the slope (64). For this, it is important to have a structural health surveillance that works as an early warning system, which continuously indicates the parameters of the structural behaviour.

There are different methodologies and procedures to carry out the corresponding slope inspections. As a starting point for the visual inspection, it is considered very important to start from the historical data of the slope. It is important to know if any other study has been previously carried out on the slope or if any kind of work has been done on the slope. Once the historical data is known, a routine visual inspection of the slope can be carried out in full knowledge of the facts.

One of the methods to carry out a correct visual inspection of slopes is through radar. It allows for the analysis of slope stability and to carry out deformation measurements almost in real time through conventional geodetic monitoring programmes. (63). The main objective of such metrology is to generate an early warning system that allows the creation of new cracks in the slope to be foreseen in advance and the prevention of slope destabilisation.

Visual inspection is considered the preliminary step to any other survey or application of the data detection methodology. It is a complementary technique that serves as a basis for providing the first sources of information for the study. This structural health inspection stage, depending on the location and geometry of the slope under study, can be considered of low complexity for its elaboration.

### 3.4 Topographic surveying

#### 3.4.1 Laser scanner

Laser scanners are a topographic equipment that captures massive geospatial data. As a result, a cloud of points is obtained that represents reality, three-dimensionally, with rigorous precision, allowing its systematic acquisition at high frequencies, in real time and associated with colour-coded values (51). The modus operandi of the laser scanner is to scan a surface, capturing thousands of points per second with a laser beam. The result, as indicated above, is a three-dimensional representation of the surface, consisting of hundreds of thousands of points, each with its corresponding coordinates (x, y, z). The resulting visualisation becomes highly accurate, as the whole point cloud can even have the same colour as the scanned surface. This is because the laser scanner also has a camera, where it relates each pixel obtained to the image taken, resulting in the exact colour of reality on the point cloud.

At present, the use of laser scanners is in great demand in projects. Given its wide scope of application in projects such as industrial measurements, topographic surveys, tunnels, installations, quarries, among many others, it is justified given the large amount of information that can be extracted from its results. As an example, the iconic Chetwynd Viaduct, built in 1851 and located just outside Cork City, was partially dismantled in the 1960s. Subsequently, it was intended to rehabilitate the bridge for pedestrian and cycling use. To this end, a survey and topographical survey was carried out using 3D laser scanning technology. The information provided by this technology was effective and optimal for determining the actions to be carried out, in addition to the control and surveillance of the infrastructure (52) throughout its useful life.



*Figure 3. 16 Chetwynd Viaduct, Cork previously subject to laser scanning technology (15)*

In addition, the use and handling of this type of topographic material does not require highly qualified personnel, and with basic topographic knowledge, field work can be carried out without difficulty in the process.

#### *3.4.1.1 Leica Nova MS60 Multistation*

In the study that is the subject of this thesis, the Leica Nova MS60 MultiStation model has been used. This is a latest generation model, which allows through the fusion of sensors to obtain total station capabilities, 3D laser scanning up to a maximum of 30,000 points per second, GNSS connectivity (Global Navigation Satellite System) and digital imaging.

This laser scanner is equipped with integrated software, which facilitates the surveying tasks to be performed. It has a function, called AutoHeight, which simplifies the arduous

task of parking the surveying device. In addition, thanks to GNSS connectivity, it enables direct georeferencing in the workflow and data structure.

The Leica Nova MS60 can be used for complex structural and object analyses, measurements of buildings and structures, 3D object-oriented models and photographic documentation of facades, elevations and heritage sites. For the monitoring and evolution of heritage structures, the use of this the Leica Nova MS60 Multistation facilitates their analysis due to the precision and quality of its results. Likewise, it is used in traditional topographic surveys for topography and mapping, as well as in inspection and analysis of soils and structures, this being the main reason for the analysis of the state of structural health of the slope located on Connolly Street.

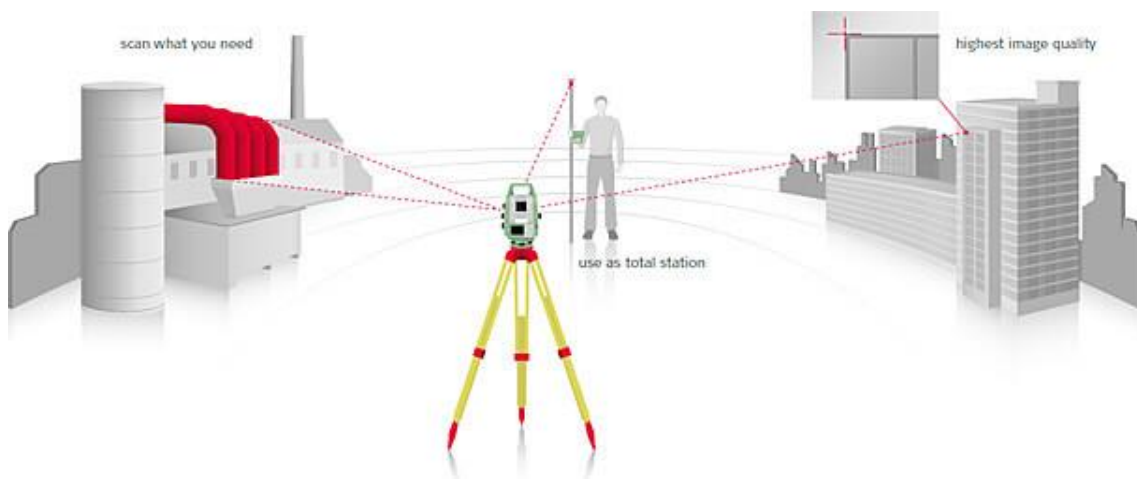

Figure 3. 17 Principle of Leica laser scanner operation (16)

### 3.4.2 Drone

A drone, also known as an unmanned aerial vehicle, is a vehicle capable of maintaining a controlled and sustained level of autonomous flight. Currently, the use of drones is at the forefront of aerial imaging, due to their speed of movement over almost all types of terrain and their ability to overcome obstacles. In addition, they offer high-resolution images and videos from a bird's eye view with the ability to carry different types of cameras, without putting anyone at risk.

There are currently a multitude of different types of drones. Some of them are called quadcopters, hexacopters or octacopters, depending on whether they have 4, 6 or 8 propellers. The drone is operated by remote control, which in most cases allows

connection to mobile phones or tablets, making it easier to see the images that the drone's camera is recording in real time.

The concept of their operation is similar to that of a helicopter, i.e. the engines are started and the propellers move to enable flight. The remote control is used to direct the flight, in a simple way, although based on the fact that it is an aerial vehicle, licencing and authorisation of flight is required. Many drones are equipped with GPS, which makes it possible to set a predefined route, i.e. the drone will automatically follow this route without needing to be controlled.



*Figure 3. 19 Quadcopter drone for surveillance (17)*



*Figure 3. 18 Drone Camera for image taking (17)*

The use of drones for civil infrastructure inspections is in great demand. Bridges are infrastructures that make inspection tasks very complex due to the difficulty of accessing certain elements of the infrastructure, such as the lower part of the deck, long-span arches and stay cables. Inspection tasks carried out in the traditional way have serious economic and time limitations and need to be performed by qualified personnel. Nowadays, this problem has found a solution in the use of drone inspection flights.

Drones are equipped with different types of payloads, i.e. depending on the type of camera or sensors they support, different types of inspections can be carried out. Thanks to the quality of the camera optics used in drone inspections, it is now easy to detect and measure cracks and fissures in infrastructures through image processing and geopositioning systems.

Another of the most common applications of drones is the creation of digital models. Due to the use of photogrammetry or LiDAR, it is possible to obtain a cloud of points

that can be processed for the creation of 3D object-oriented models. In the case of this study, one of the 3D object-oriented models generated of the Connolly Street slope has been created thanks to the flights made with a drone.

### 3.5 Building Information Modelling (BIM)

#### 3.5.1 Introduction to BIM

The Building Information Modelling (BIM) methodology is an idea proposed in the last century. Specifically, it was Charles Eastman, together with other people, who in 1974 presented a study called "Building Description System Outline", where the basis of what is currently known as BIM was born. (65). It was from then on that 3D modelling began to be developed, with the first designs supported by BIM (66) modelling and the first CAD supported designs. For years, the construction sector was limited to the usual 2D design, and it was not possible to incorporate innovative tools (67) and it was not possible to incorporate innovative tools of the time for parametric modelling and analysis.

The incorporation of 3D modelling together with existing parametric analysis tools revolutionised the construction industry. It started the representation of information in a structured way (68). Moreover, thanks to the compatibility of the use of different types of software and tools, it allowed the design, management and sharing of information in a digitised way between different multidisciplinary sectors (69).

BIM is based on a collaborative work methodology, i.e., where the entire life cycle of the project can be covered from a single digital model. This, in turn, will be managed through various computer tools, where all the people involved in the project work on the evolution of the project in real time and simultaneously without negatively affecting its development. The result of its use is focused on the pre-planning, design and construction of projects, whether they are buildings or infrastructures. Focusing the study from the first life cycles, through maintenance and/or renovation, and ending in the final phase of the structure's useful life (70) (67).

BIM projects include not only a geometrical definition of any element, but all possible information that can be included in it. It is a common misconception that BIM is only a 3D modelling of unattributed objects, i.e. objects that lack information (71). In reality, BIM methodology is considered as 7D modelling, i.e. there are different levels of

development depending on the design phase considered (72). It starts from a 3D digital model, which is considered the basis for further extensions, and from there, when temporal data relating to the construction phase of the project is added, the model is elevated to a higher level of development, in this case 4D models, where it is possible to carry out work and cost planning (5D models). When facility management procedures are incorporated into the model, the development level is 6D models, after which the various sustainability assessments can be carried out in so-called 7D models. The following figure shows the different levels of development in more detail;

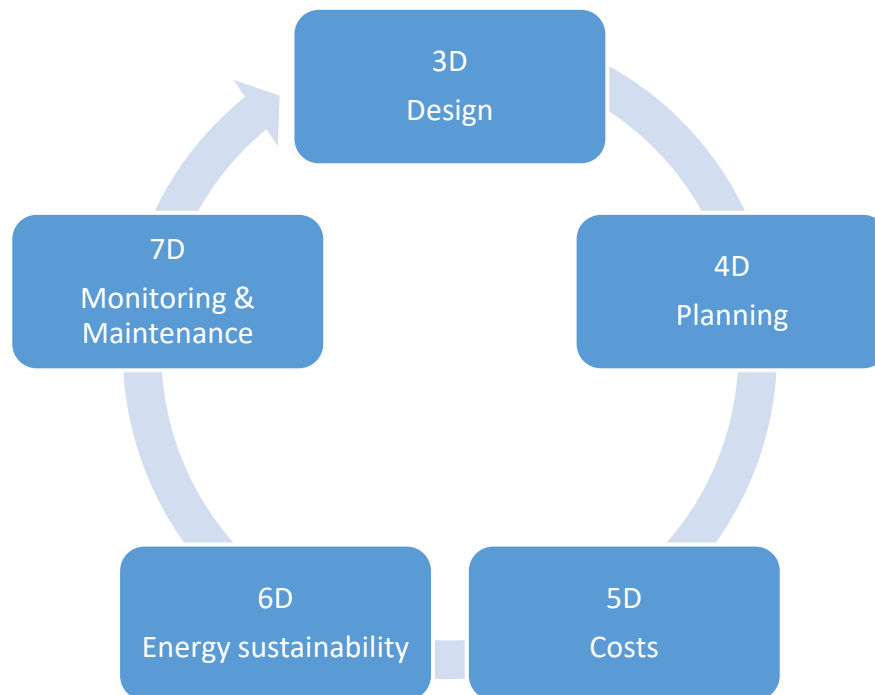

Figure 3. 20 Diagram of the different levels of BIM development

### 3.5.2 Advantages of using BIM

- Information grouped into a single model with data integrity, allowing for immediate updates to the model. This provides real time information through the combination of slope sensor data integrated onto the 3-D orientated models.
- Possibility of pre-construction, i.e. following the identification of slopes or retaining walls requiring interventions, such repair works can be planned and designed in advance allowing for a structured and clear approach.

- Reduction of project modification times. Through the incorporation of slope data, vulnerable areas as well as repair plans onto a single model, inconsistencies and margins of error are reduced.
- Reduction of production, construction and operating costs.
- Detection of design errors. Since BIM integrates a wide variety of model visualisation software, it allows for the detection of possible design errors. Furthermore, thanks to interoperability, it allows for a flow of information between different software's ensuring structural integrity.

One of the great advantages of processing data from structural health monitoring in BIM is the visualisation of the modelling as a whole. Rio J (73) presented a study in which he evaluated the Industry Foundation Classes (IFC) standard as a tool for a real building that was instrumented and equipped with sensors. In doing so, he wanted to show the limitations of the IFC model and propose extensions of the sensor classes in SHM. Similarly, Theiler M (74) presents a study where he describes the information related to monitoring through information modelling in BIM. It is an IFC-based approach, being an open BIM standard facilitating the interoperability of BIM models. Therefore, interoperability can be considered as a mandatory requirement that makes BIM a multidimensional tool.

There are a multitude of different formats associated with BIM, which offer the possibility of being able to work and analyse a model in different software without any issues. In this way, a parametric model created in Revit can be exported to Tekla, a BIM software for the detailed structures analysis. The following table shows some of the formats associated with BIM.

*Table 2 BIM and data exchange formats*

<b>DXF, DWF, DWX, DWG, DXF, SAT, IFC</b>	AutoCAD
<b>RVT, RTD, NWC, ISO-STEP</b>	Revit, Robot, Naviswork
<b>GEO</b>	AutoCAD Civil 3D
<b>XLS</b>	Excel
<b>CSV, DAT, TXT</b>	Software exchange



### 3.5.3 Dynamo

Dynamo is a software that was developed in the last fifty years as a means of simulating system dynamics. Its use is gaining popularity through advances in the various areas that it can be applied (75). Dynamo allows the capabilities of Revit to be extended in relation to its capacity to work with data and the logic of a graphic editor of algorithms. In order to do so, it must be done through Revit, using it as a plugin.

Through the use of simple nodes, Dynamo simplifies processes that would otherwise be arduous and time-consuming. However, Dynamo simplifies programming tasks also thanks to the help of external packages with infinite functions in their contents.

Another aspect promoting the use of Dynamo is in the creation of complex structures. Revit does not have a library of families dedicated to civil works, which greatly limits the ability to create complex structures. Dynamo allows the creation of any type of geometry without limits. Moreover, as it is a Revit plugin, the connection between both software is immediate, i.e., the possibility of visualising the Dynamo design in Revit is active during the whole process of its elaboration.

The presence of Dynamo as a visualisation tool is becoming an increasingly common feature in structural health study projects. Due to the high resolution of 3D images and the amount of information provided, BIM methodology is required as a data management tool, where data analysis and evaluation for structural health monitoring can be carried out. Recently, the monitoring of a three-storey high aluminium structure was carried out, where Dynamo was successfully implemented to manage the information between sensors and the BIM model. Thus, Dynamo enabled a data reading language to be established, creating a defined threshold for possible damage to the structure, thereby creating an early warning system for structural anomalies (76).

### 3.5.4 Digital Twin

The definition of structural health monitoring is intrinsically linked to BIM today. This is due to the great advantages of implementing BIM in a structural health project, be it in cost reduction, time or the power of visualisation. It is now increasingly common to speak of the 'Digital Twin', a concept that perfectly defines the binomial between BIM and SHM.

It was in 2002 when Michael Grieves (77) gave one of the first definitions of ‘Digital Twin’, described as a construction of digital information based on a physical system, created as an entity in itself and connected to the physical system. Later, it was Stargel Glaessgen (78) who provided a more precise definition of what is nowadays understood as Digital Twin: "The digital twin is a probabilistic, multi-physical, multi-scale simulation of a complex product that uses the best available physical models, sensor updates, etc., to accurately reflect the life of its corresponding twin".

The digital twin system (Figure 3.21) refers to the virtual replica of a product, be it a part of a wind turbine, building, infrastructure, etc. This replica is fed back with real-time data, which can be captured through sensors, or ‘Big Data’ technologies. It is very common to confuse a Digital Twin with a simulation, but the reality is that there are big differences between both concepts. A simulation aims to study a specific process, while a Digital Twin carries out multiple simulations in order to study a large number of processes in a single model. In addition, simulations are not usually fed by real-time data, whereas a Digital Twin is designed in an environment where all the bidirectional information flow that is produced comes from strategically chosen and positioned sensors to study and evaluate the product or infrastructure. Together, the digital twin evolves at the same time as the actual model it reflects (79).

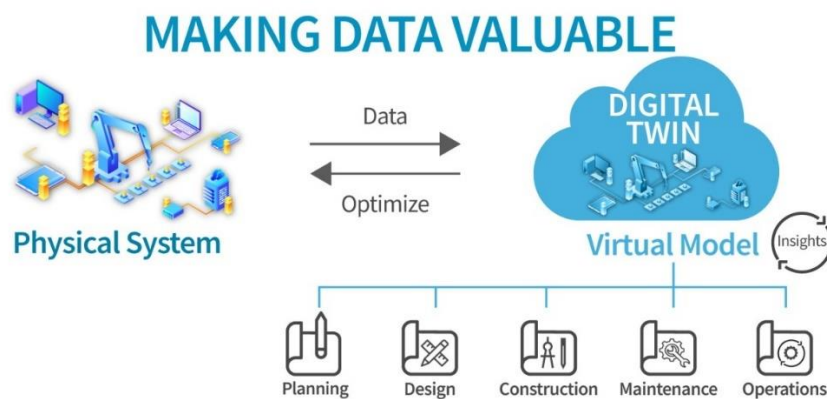

Figure 3. 21 Application of digital Twins (18)

In general, when referring to a system that mirrors the functioning of another system, it is defined as a model. Models created by Digital Twin are not intended to be exact copies of the original model, i.e. the Digital Twin discards key features of the original model leaving the characteristics and properties of the real system to be mirrored and

evaluated (80). However, there are projects where the digital model is very close to reality, as it is intended to reflect all the characteristics of the real system as closely as possible.

The implementation of a Digital Twin in a project allows the research and design of such a process to be effective, as the digital model provides a large amount of real data and facilitates multiple performance results. It therefore allows the project to be refined well in advance of its execution. Digital twin is a term that can be further categorised according to the level of data integration; digital model, digital shadow and digital twin. Digital model describes a representation of a physical model through manual data exchange. If there is an automated one-way data flow incorporated into a digital model, this is considered a digital shadow whereby a change in the state of a physical object results in a change in the digital object in a unidirectional flow. Further integration with automatic data flow bidirectionally between the physical object and digital object is described as a digital twin- changes to the digital object results in changes in the state of the physical object and vice versa(81).

There are currently hundreds of projects where a digital model has helped to study and evaluate the behaviour of specific features in the development of a product. Digital Twins is commonly used to monitor wind turbines, as it allows for the prediction of the power generated by wind turbines when environmental conditions are known and highlights potential machine failures given common characteristics(82). Another application of Digital Twins is the evaluation of complex in-line product manufacturing processes in large factories, where several production processes are linked together. By creating a digital model, it is possible to optimise these production processes by reducing production sub-processes and reducing consumption and economic costs. This application was carried out in a brewery in Spain (83), where it was possible to evaluate the economic impact of the twin on the plant, speeding up the production yield processes of the bottle line and a new distribution of the production lines to optimise the process.

Another example where structural health monitoring was combined with BIM was in the design of SHM for a historic offshore lighthouse, in which O'Shea M. and Murphy J. (84) demonstrates that, through the use of wireless sensors and their connectivity with the

Internet of Things, health monitoring of an existing structure could be carried out for asset management through the use of BIM. Valinejadshoubi M (85) explores different BIM techniques with the aim of facilitating data management and representation of the sensory components of a SHM system in a building based on the interpretation of sensor data. In the study, the different damages caused to the infrastructure are highlighted by colour coding according to predefined values.

There are many projects that carry out their health monitoring study of different types of infrastructures using BIM. This is due to the advantageous optimisation of the system, the efficiency in results, the speed of data processing and the interoperability that BIM presents in the field of SHM.

In the United Kingdom, the Centre for Digital Built Britain (CDBB) is a joint venture between the Department for Business, Energy & Industry Strategy (BEIS) and the University of Cambridge, which aims to deliver a smart digital economy for UK infrastructure and construction. It is also home to a number of UK government programmes, including the BIM Programme, the National Digital Twins Programme and parts of the Global Infrastructure Programme. CDBB's main objective is to digitalise the entire lifecycle of its built assets. To do this, they investigate how to provide more capacity for the country's existing infrastructure from the social and economic infrastructure and therefore make better use of the infrastructure by the citizens. Its core mission is to "develop and demonstrate policy and practical knowledge that enables the exploitation of new and emerging technologies, data and analytics to improve the natural and built environment, thereby boosting competitiveness and business productivity, as well as the quality of life and well-being of citizens" (86).

The National Digital Twin programme led by the CDBB, was set up to ensure high quality and secure data, thereby meeting the key recommendations of the 'Data for the Public Good Report'. National Digital Twin offers a number of benefits to all stakeholders through transparent engagement. In addition, it presents a benefit to the country's economy, due to increased national productivity through efficient and resilient infrastructures, improving their lifespan.

Some of the CBDD projects carried out show the importance of structural health monitoring through the monitoring and visualisation of this information collected in a Digital Twin. In the project "Digital Twin Journeys: smart infrastructure for safety and reliability across the rail network" an investigation was carried out on two instrumented railway bridges. The large amount of data it revealed on the digital twin showed wear and stresses on the bridges, helping asset owners to predict in advance when maintenance work would be needed on the bridges and meet their key priorities. This is achieved through the network of inclination sensors, bridge deformation and location sensors that allow the weight of trains crossing the bridges to be calculated and the state of loads they are subjected to, to be assessed. All monitoring tasks are performed remotely, reducing the subjectivity of monitoring by human inspectors, as factors such as light levels, weather and variations in alertness can influence the subjective assessments made by inspectors. In addition, the use of remote sensing makes it possible to identify problems that may arise before visual inspection can detect them. Even so, a lack of accuracy was detected in the data obtained in the train weight prediction, as this is affected by ambient humidity and temperature. To solve this problem, humidity and temperature sensors were added to the project to help take these factors into account in the final result. In addition, accelerometers were installed to calculate the rotational constraints at the boundary conditions to improve the weight accuracy (86).

It is clear that a major shift has taken place in today's operating models. It is a digital reinvention in asset-intensive industries, changing models in a disruptive way, with digital twins being a key part of that realignment. Digital twins are constantly changing, developing new skills and expanding capabilities.

#### 3.5.5 Economics of SHM

Structural health monitoring of any infrastructure aims at assessing the structural behaviour and the anticipation of possible damage caused (87). To carry out monitoring, as mentioned above, the vast majority of data collection and monitoring processes are carried out through sensors. There are an infinite number of sensor types on the market, which meet the requirements of the project demands. Among the great advantages of the use of sensors in SHM is the reduction of economic costs in the projects.

Traditional structural health monitoring systems are often quite arduous to carry out in the field and involve large financial investments in the project. Therefore, current projects are opting for the use of low-cost sensors for monitoring. They fulfil key functions for assessing structural health and reduce economic costs, survey times and inspection risks.

In mid-2020, Swindon's Deanery Church of England Academy completed work on its school. It was a major project as the school houses state-of-the-art laboratories, theatres, workshops, indoor sports hall, food court and a chapel. The school accommodates 1,600 students. The construction of the school was in line with the UK Government's Construction Transformation Strategy, and has been a clear example of how the Department for Education has been adapting to the benefits brought by BIM. From the early stages of the project, the information management processes and use of technologies were pre-established and this resulted in direct cost savings of over £50,000. It was estimated that any delay in delivery would add £15,000 per week, but by managing the project with BIM, the risk of project delays was reduced. Thanks to the digital model of the Academy, it was possible to optimise the design of the classrooms, leading to changes in the design of the overall structure of the building. This resulted in variations to the design brief and a saving of £14,000 in this respect (86).

In BIM and Digital Twins projects the power of information plays an essential role, as it allows for the prediction of possible project failures in advance and therefore avoids unforeseen costs.

### 3.6 Conclusion

Structural health monitoring has evolved with modern day technology resulting in accurate surveillance and early detection of structural changes. It can be seen that SHM can be an arduous task requiring long hours and skilled personnel with a high economic cost. Furthermore, SHM often provides information at intervals in time instead of continuously meaning that the data on a structure under surveillance may be obtained after a time when optimal repairs cannot be carried out and therefore the safety in a structure is compromised. Megastructures in China have been subject to SHM using sensors deployed during construction. These sensors highlight how continuous data is possible ensuring the structural integrity of the structure at all times and therefore

optimising structural safety for its users. These sensors provide basic information requiring lengthy analysis and therefore hindering their interpretation. The above demonstrates the application of SHM in civil infrastructure however its application to geostructures has not been explored in depth. The principles from the use of SHM in civil infrastructures can be translated and applied to geostructures for accurate surveillance and monitoring.

The areas that are explored further in this thesis are:

- Developing an early warning system that is accurate in its results ensuring repairs at optimal times.
- Providing continuous data on geostructures (soil slopes and retaining walls).
- Creating a cost-effective surveillance technique.
- Using multiple modern surveillance techniques, combine their results for a novel surveillance approach.

For this thesis, a soil model was created using the Plaxis software to determine the stability and stress deformation of the slope under study under different conditions- low tide and high tide. These two circumstances were applied to the soil slope model due to its location in close proximity to the sea. Using data provided by the Office of Public Works (88), the most extreme tide circumstances recorded in the area were applied to the slope model to establish how the soil slope could potentially behave under these circumstance. This software provides valuable information on the strength and susceptibility of the soil slope.

This thesis questions the application of remote sensing in the surveillance of soil slopes and retaining walls. There is uncertainty surrounding their use and the value of the information provided by sensors. Although their application has been seen for structures such as the Guangzhou, China (40), their use for providing continuous data on geostructures in adverse conditions has not been explored in-depth.

Through the combination of drone flights and laser scanners, structural surveillance has expanded dramatically. There have already been advancements in the use of remote sensing methods in the setting of landslides however there are still a number of questions surrounding the true strength of software such as drone scanners (89).

BIM has been established as a key addition to engineering with its application widespread, especially in the construction industry (90). Although it has been recognised as such an important element of engineering, its use for geotechnical data has not been established and so to date, there are limitations on its use (91). This project aims to further expand on its use in geotechnical engineering.

From the above, it can be seen that there are a number of different software's that play key roles in the engineering world. Individually, their use is established however collectively their use has not been combined. This thesis proposes a technique of combining these technologies as one procedure in the structural health monitoring of at-risk soil slopes and retaining walls. Furthermore, the economic cost of such an undertaking is analysed to compare to current methods which are costly and difficult.

The results obtained through SHM are often difficult to understand, distorting the interpretation and hindering the process of establishing the structural safety of the object under surveillance and the identification of the areas requiring repair. Through the use of BIM software, this thesis proposes a manner in which the SHM results are displayed in an easy to understand manner with clear identification of areas at risk.

From the above literature review, it can be seen that a novel way of geostructures surveillance in real time with continuous data and easy to interpret results in a cost-effective manner is required. This is possible through the use of various methodologies however, for the purpose of this thesis, terrestrial laser scanning, drones and remote sensing with accelerometers and gyroscopes were used to display how real-time surveillance of slope behaviour is possible. The resulting EWS is clearly displayed through BIM software.



## 4. Data Collection Methodology

Through the use of a five-step process, an early warning system has been developed. Each structure being monitored is first inspected visually to identify any gross damages easily visible to the naked eye. The structure then undergoes more detailed analysis through the use of a laser scanner as well as an unmanned aerial vehicle or drone. Using these techniques, a point cloud of the structure is developed where the early warning system will be visualised. Through the use of sensors, along with Revit and Dynamo, the early warning system will be programmed in order to acquire data in real time.

### 4.1 Identification and visual inspection of retaining walls and slopes

Identifying slopes and retaining structures suitable for a real-time SHM system was the first step in the project. Utilising information provided by Cork County Council from previous visual monitoring campaigns and works undertaken for slope improvements, as described in Chapter 2 of this study, a set of retaining walls and slopes at risk in the town of Cobh were selected. An order of priority for action was established for those retaining walls and slopes that were considered to be at greatest risk. It was decided to carry out an analysis of four retaining walls and one earth slope in the locality. The main focus of study of the investigation was the earth slope, which was subject to inspection and monitoring through various methods.

The table below lists the retaining walls and slopes subject to study in this research paper, as well as their location and nomenclature.

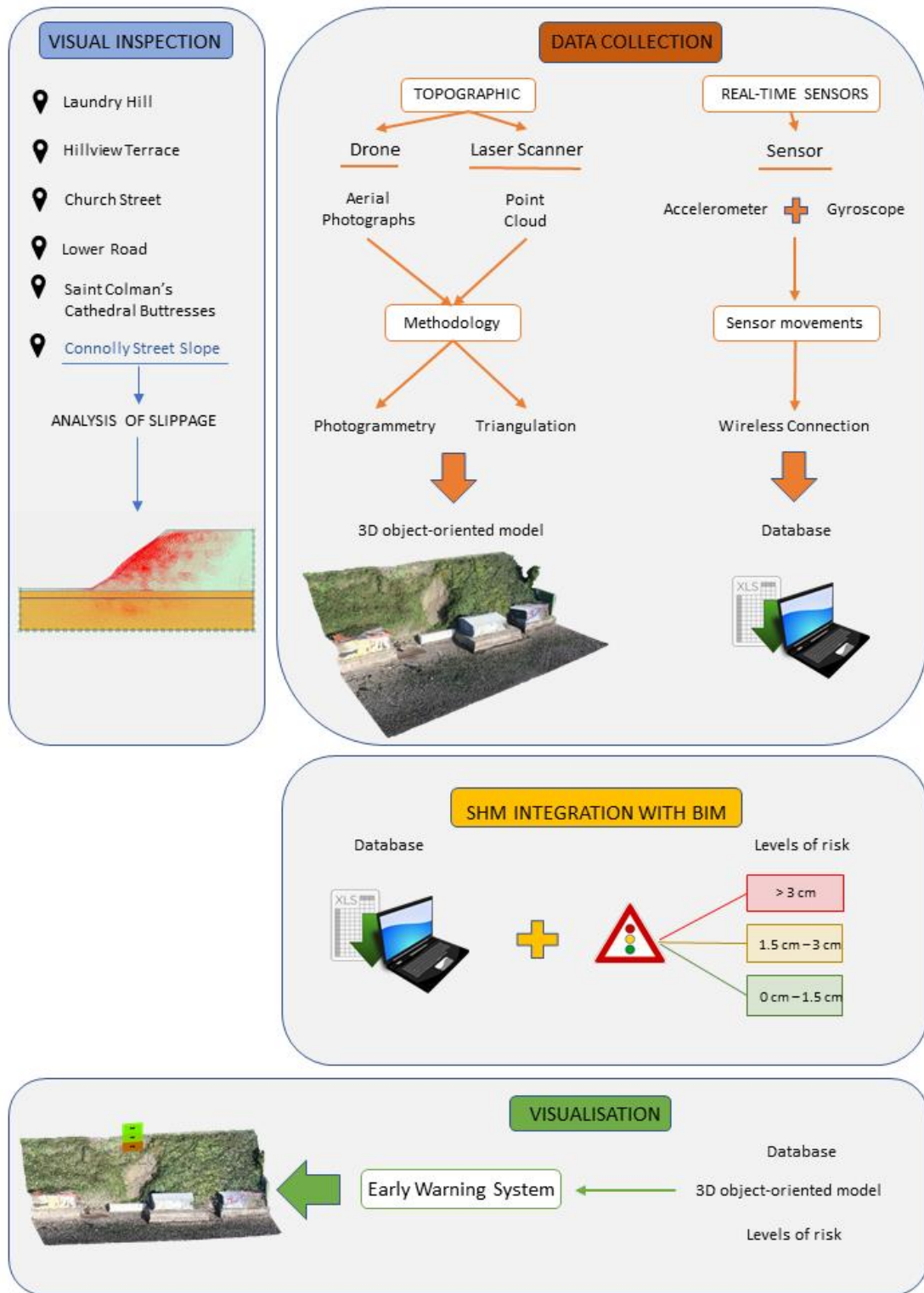

Figure 4. 1 Overview of the methodology applied in the research project

Table 3 Surveyed walls and soil slope

Wall Name	Wall Number	Length	Structure Type	Damage Type
Laundry Hill	105	40.9 m	Masonry Wall	Cracks and crevices
Hillview Terrace	10	102.4 m	Masonry Wall	Cracks and crevices
Church Street	35	70.3 m	Masonry Wall	Cracks and crevices
Lower Road	72	182.8 m	Masonry Wall	-
Connolly Street	16	284 m	Soil Slope	Partial surface landslide
Saint Colman's Cathedral Buttresses	-	72.2 m	Masonry Wall	-

The above sites were selected by analysing the list of at-risk retaining walls and soil slopes identified by Malachy Walsh and Co in combination with the GSI map of landslide susceptibility in the Cobh area. From this, the sites in areas of high susceptibility were included and sites with lower risk of collapse or destruction excluded.

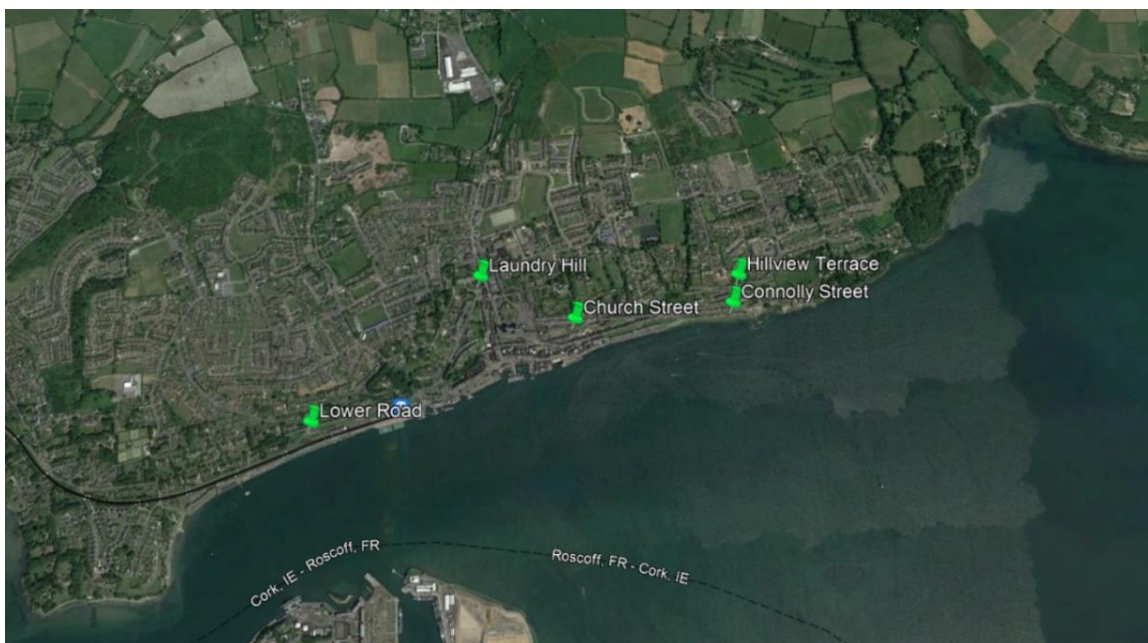

Figure 4. 2 Aerial view of the slope and retaining walls for monitoring in Cobh (19)

#### 4.1.1 Laundry Hill

Laundry Hill is a 41-metre wall that is located on one of the two main roads in the town. Its main function is that of a retaining wall for a residential property however there is a busy footpath along its route along with public on street parking adjacent to it. Based on an initial visual inspection, Laundry Hill was included in this study as there were a large number of cracks in the wall. In addition, as it serves as a base support for the garden of a house just behind it, there is growth of vegetation in the cracks, causing further deterioration of the structural condition of the retaining wall.



Figure 4. 3 Laundry Hill (19)

#### 4.1.2 Hillview Terrace

The wall of Hillview Terrace, located to the west of the town is built on a steeply sloping street. The long wall follows the slope of the hill and in turn supports the floor of a terrace of houses. The condition of the retaining wall is acceptable, but due to the passage of time and the load it has been subjected to, there are visible cracks.



Figure 4. 4 Hillview Terrace (19)

#### 4.1.3 Church Street

The wall being studied on Church Street is located at the upper end of Church Street. Church Street is a narrow road that has traffic in both directions, on street parking as well as a footpath on both sides. The wall being studied is a boundary wall for a row of houses with their gardens finishing on top of the wall with hedging. The structural condition of the retaining wall is poor with numerous cracks and fissures along the length of the wall, as well as loss of verticality in certain sections of the wall.



*Figure 4. 5 Church Street (19)*

#### 4.1.4 Lower Road

The wall on Lower Road is a wall of considerable size in height and length. The current state of structural health is acceptable due to conservation work in recent years with repointing of bricks and the insertion of tie bars and pattress plates although it has some cracks that do not represent a risk. It also has a lot of vegetation on its main facade, which is not structurally beneficial. It is located opposite the Garda barracks and close to the train station, and it is due to its location that it was considered for study.



*Figure 4. 6 Lower Road (19)*

#### 4.1.5 Saint Colman's Cathedral Buttresses

Saint Colman's Cathedral Church was built in 1919, taking almost 51 years to construct due to increased costs and revisions to the original plans. It is now the church with the tallest steeple in Ireland at 91.4 metres. It is in perfect structural condition, although concrete spraying work has been carried out by the Malachy Walsh Company on the surrounding slopes to prevent possible landslides affecting the surrounding houses. One aspect of the cathedral structure that contributes to its strength and durability is the foundations on which it is built. One element of interest of these foundations is the buttresses that run for 72-metres to the south of the main cathedral building. Built to support and strengthen the structure of the cathedral, as well reinforce the terrain surrounding the cathedral the buttresses appear to be undamaged and in pristine condition having withstood time and weather. Based on the integrity of this structure, the buttresses underwent analysis to assess, at a higher level of detail, if there is any damage that is not visible to the naked eye as well as to display the level of detail available from laser scanners.



Figure 4. 7 Saint Colman's Cathedral Buttresses (19)

#### 4.1.6 Connolly Street

The slope on Connolly Street is located to the east of the town in a busy location with commercial traffic and trucks as well as many residential properties surrounding the slope and it is adjacent to a busy fishing pier that is also used by the coastguard. Above the slope, which has been subject to previous landslides, is a two-lane asphalt road that is less than one metre from the slope with an old stone wall separating the two. South of the slope, is the water of Cork Harbour.

This earth slope has suffered several landslides in recent years, and preventive measures have been taken, mainly through the construction of a retaining wall at its base. In the first visual inspection of the earth slope, the severe damage suffered in recent years was clearly evident. The retaining wall built at its base retains the landslides that have occurred and it was clear that further damage to the wall is ongoing. Although the retaining wall prevents further damage from rising tides and damage from the sea, vegetation, vibrations from the road and adverse weather are still damaging the slope further. Given the angle of inclination of the slope and the fact that it supports the load of a road, it is considered to be a high risk. The degree of concern led to this slope being the central focus of this paper. The aim was to create an early warning system, based on a network of sensors that monitor the structural health of the slope in real time.

Based on the location of the slope, in close proximity to a road and houses, any further deterioration in the slope stability could result in collapse of the road and potentially put human life at risk.

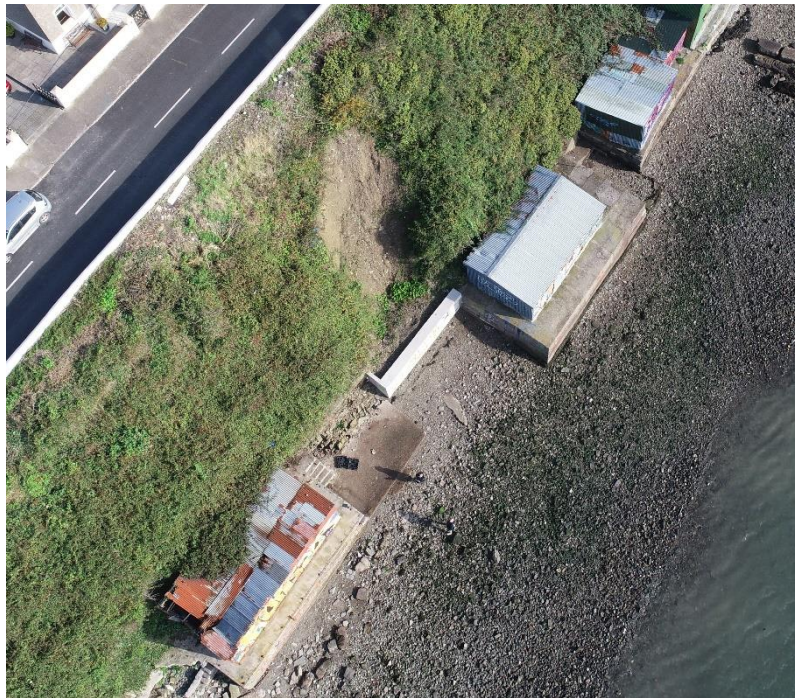

*Figure 4. 8 Partial landslide at the Connolly Street Slope (19)*

In addition, the documentation provided by Cork County Council was consulted, where, in 2016, the company Malachy Walsh elaborated a monitoring plan for the retaining wall to prevent landslides on the slope. The same document showed the different strata that made up the slope, clay and gravel, although the vast majority was composed of sandstone. Precisely because of this material, the climate of the area and the location of the slope in front of the sea, which causes constant erosion on the slope, rapid deterioration was evident.

#### *4.1.6.1 Analysis of Connolly Street slippage*

In this context, an analysis of the slope stability was carried out using Plaxis software, in order to verify, according to the parameters provided, the behaviour of the slope and the possibility of landslides. The main task was to analyse and calculate the possible behaviour of the slope under different geotechnical conditions. Therefore, a study was carried out using the finite element method, which is based on the division of a continuum into a set of elements that are interconnected by a series of nodes. The



stability study of the Connolly Street slope using Plaxis was carried out according to the Mohr-Coulomb method, which is based on a first approximation of the general behaviour of the soil. Soil-specific parameters such as Young's modulus, Poisson's ratio, cohesion, friction angle and dilatancy angle were considered for this study. The Mohr-Coulomb method was applied based on its mathematical simplicity, clear physical meaning and level of acceptance. The two stiffness parameters; Young's modulus and Poisson's ratio were applied as the slope was tested in a uniaxial compression. The strength parameters, cohesion, friction angle and dilatancy angle were applied to model the cohesion, friction and plastic volumetric strains on the soil slope. The combination of stiffness and strength parameters allowed for an analysis of the Connolly Street Slope to assess for which conditions would result in the isotropic model to fail (92).

The data provided in the Malachy Walsh monitoring plan was used as a reference, where the slope geometry consisted of two layers of clays and gravels. Additionally, a distributed load of 20,000 KN/m<sup>2</sup> was applied, due to the two-way street at the top of the slope.

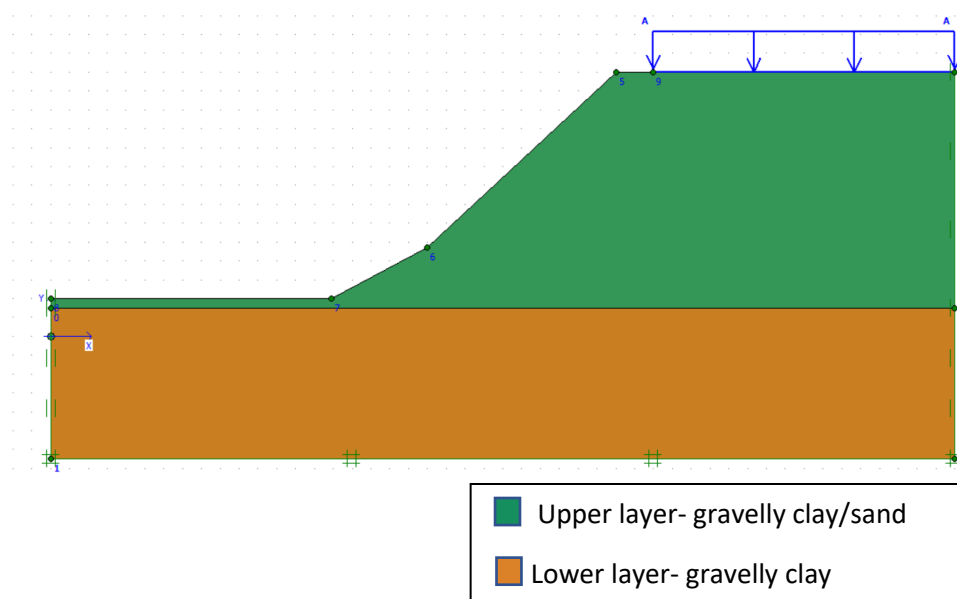

Figure 4. 9 Design geometry and materials in Plaxis software

Considering the location of the slope facing the sea, the decision was made to carry out the stability study with a water table that would give the most unfavourable outcome in relation to the stability of the slope. Several studies were carried out with different

water tables in order to verify how the slope would react to different pressures and deformations.

Using the Plaxis software, the slope was studied under the conditions of low tide to assess how the slope behaves.

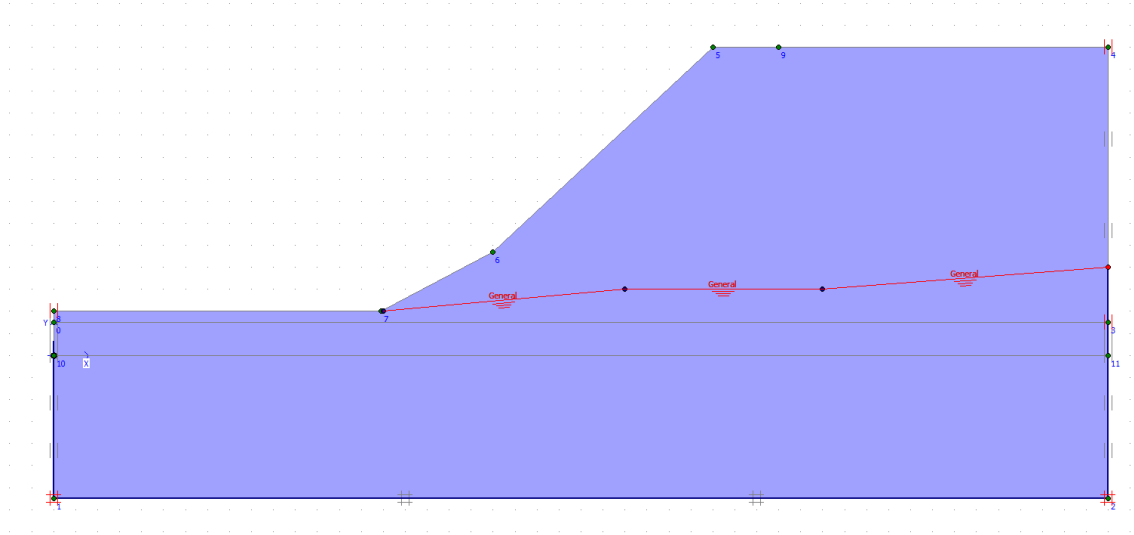

Figure 4. 10 Study of the stability as a function of the water table at low tide

In relation to the pore pressure and the initial stress of the slope, the results obtained varied in relation to the water table. Subsequently, the calculation of the stability resistance according to the Mohr-Coulomb model was carried out, which showed the possible landslide that could occur on the slope. A subsidence of the crest where Connolly Street is located was observed in addition to a very marked horizontal displacement.

Further studies on the slope stress, displacements including incremental displacements were carried out at low tide, as can be seen below.

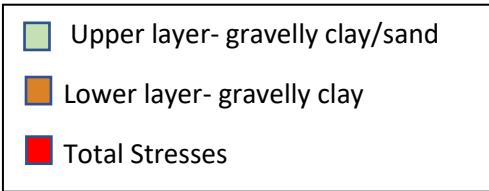
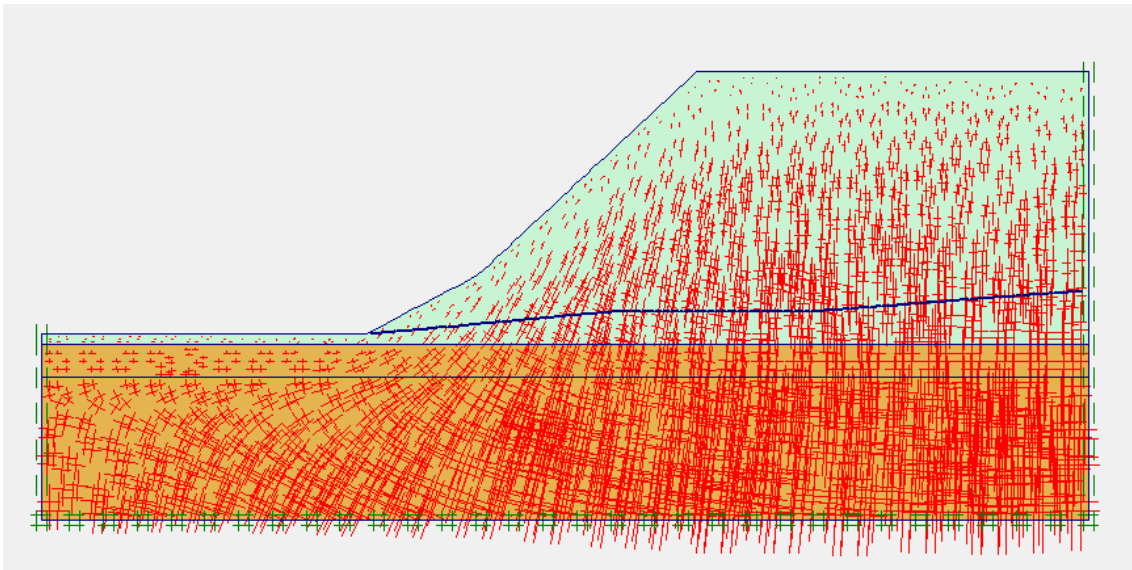

Figure 4. 11 Slope stresses at low tide

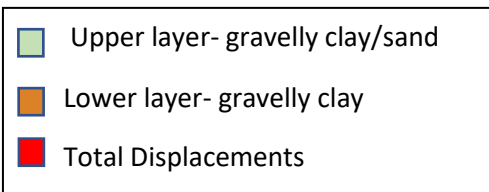
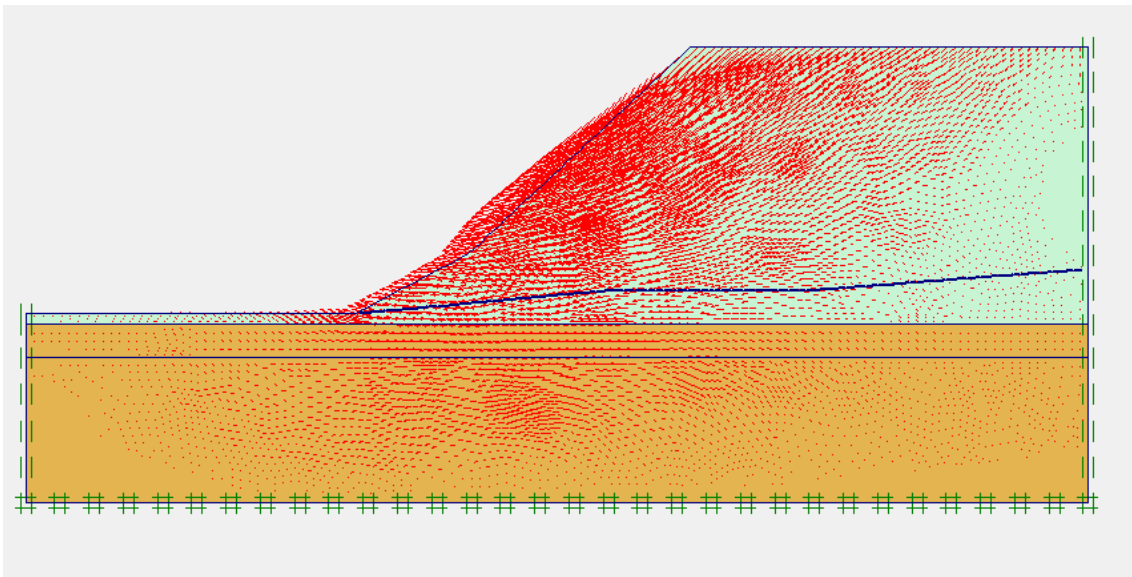

Figure 4. 12 Total displacements at low tide

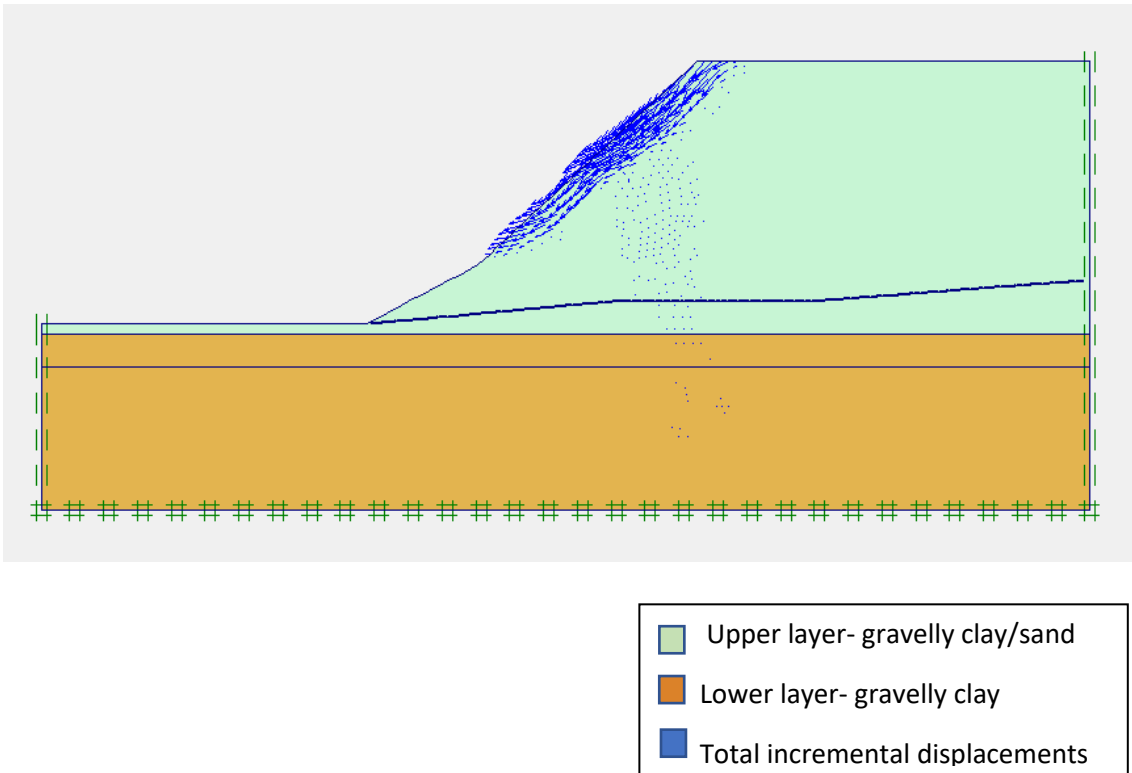

Figure 4. 13 Total incremental displacements at low tide

Studies were also carried out on the slope stress, displacements including incremental displacements and strains at high tide, as can be seen below.

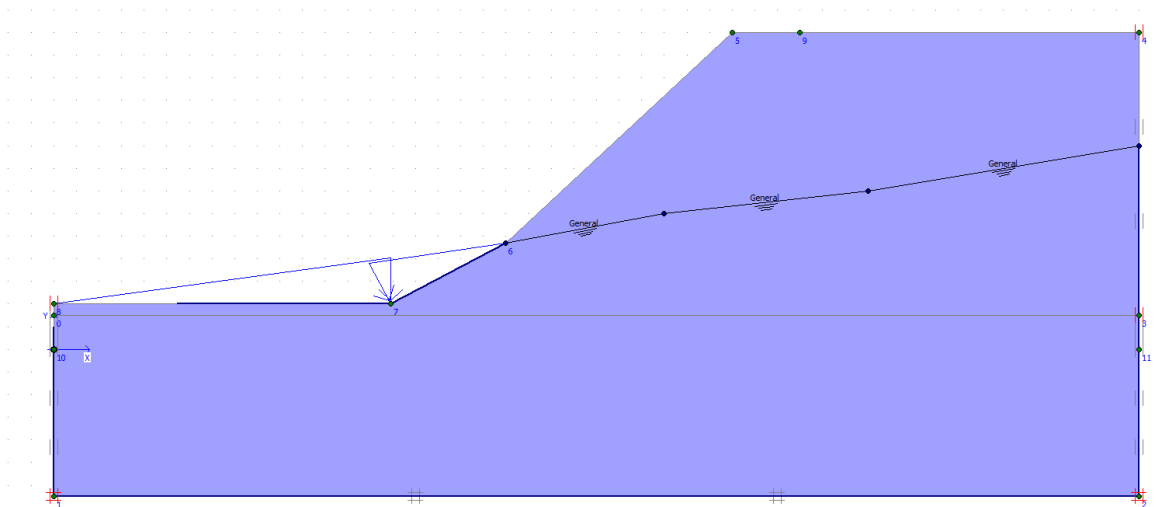

Figure 4. 14 Study of the stability as a function of the water table at high tide

Deflections were clearly marked on the visible face of the slope, where a previous landslide had already occurred. Hence the importance of acting on the slope. Thus, this research decided to focus its study on the slope and to carry out an early warning system specifically designed on the geometry of the slope.

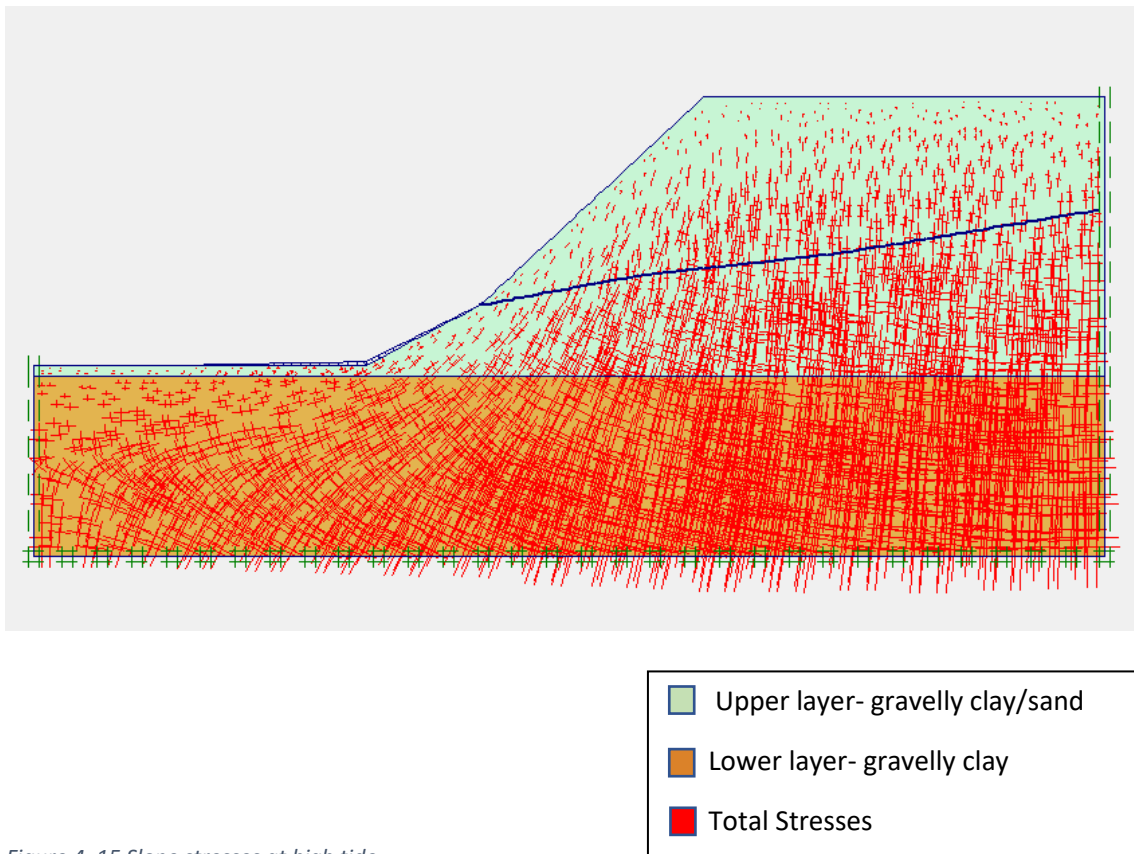

Figure 4. 15 Slope stresses at high tide

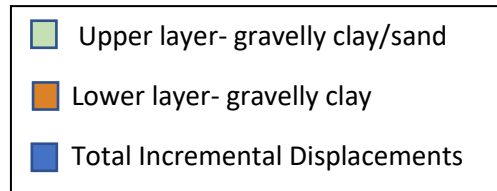
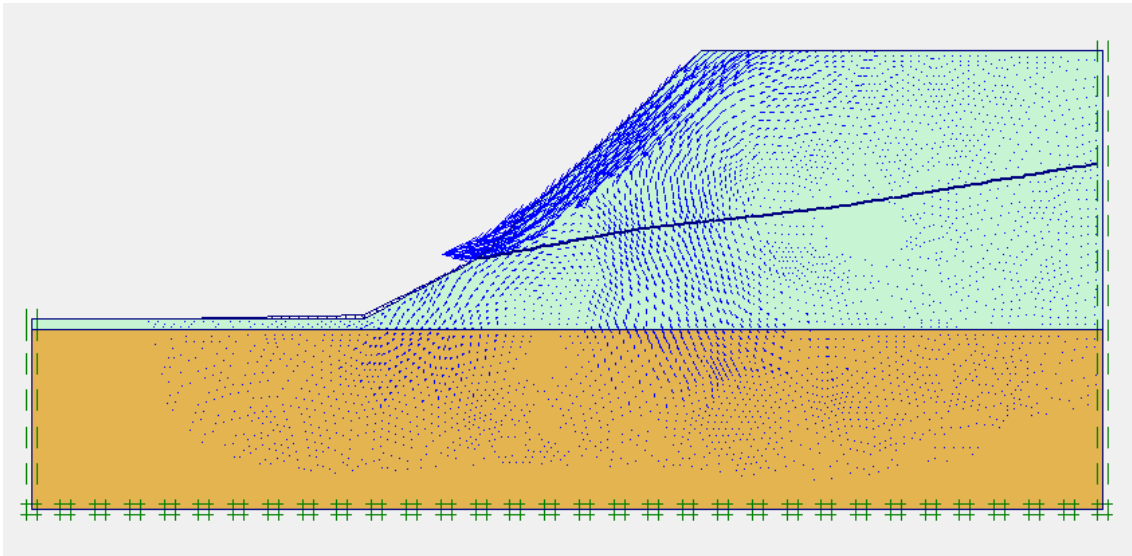

Figure 4. 16 Total incremental displacements of the slope at high tide

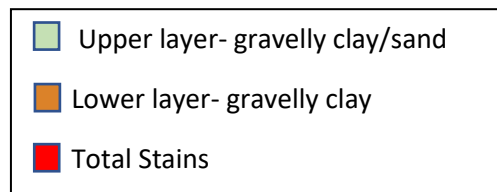
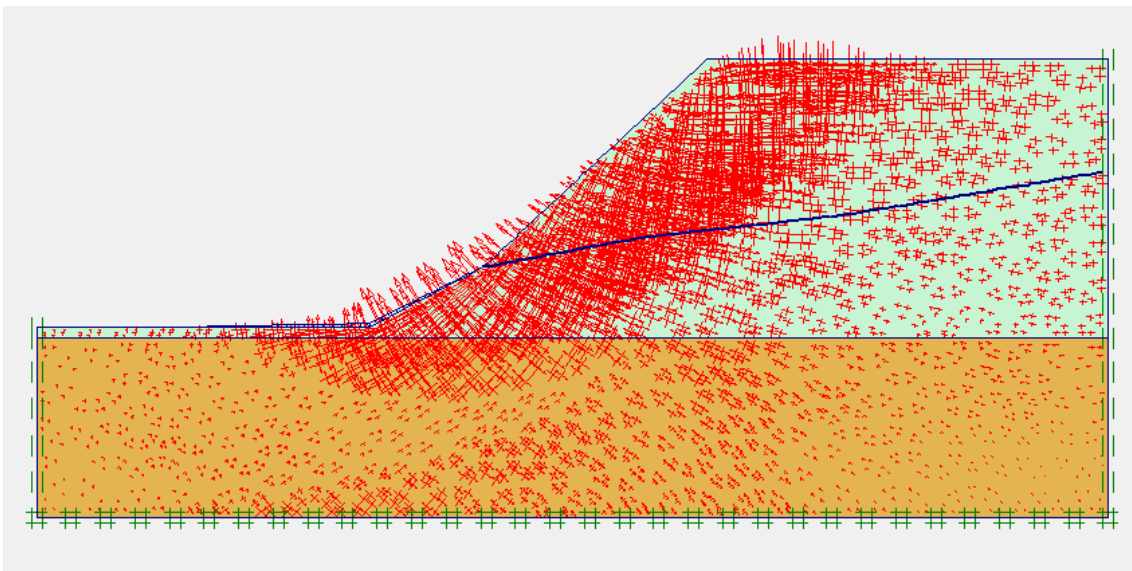

Figure 4. 17 Total strains of the slope at high tide

It was decided to carry out a study on the stability of the Connolly Street slope according to the water table based on its location, facing south bordering with the sea. In carrying out such studies the water table plays an important role as it affects the stability of the slope due to constantly changing tidal levels. The tidal data was obtained from the Office of Public Works Floodinfo.ie website (88), which provides information corresponding to the different tidal heights for up to the past 100 years. This data was relevant when carrying out the slope stability study, as the conditions of the worst-case scenario could be applied. It was from this data that the Mohr-Coulomb Plaxis feasibility study was carried out.

#### 4.2 Topographic Data Collection

To create an accurate structural health monitoring BIM integrated system, accurate high-density surveys of the structures being monitored is required. Such surveys have the ability to be repeated and replicated as required whilst being quick in obtaining their result and coming at a low cost. Through the use of laser scanners and UAV drones, the structures can be extensively surveyed providing imaging that can be processed into a 3D point cloud or mesh for the visual representation of the early warning system.

##### 4.2.1 Laser Scanner Data collection

For the data collection, firstly, and after having identified the retaining walls and slopes to be studied, a CAD file had to be generated with the geolocation of the retaining walls and slopes with an accuracy of 20mm. This information was obtained by GPS. Following this, the information could be transferred to a Civil 3D file, which would allow the retaining walls and slopes to be located on a 3D plan. Finally, all the collected information was integrated into a BIM model, thus compiling a geographically accurate model of the town.

Before generating the point cloud for each of the retaining walls and slopes, GPS must be used again to create reference points, which are then used in the laser scanner to establish a resection for each of the scanned elements. Once this is done, a resection is made using these points to scan the elements with an accuracy of 6mm.

In order to carry out the laser scanning of the earth slope located on Connolly Street, firstly, a key positioning of the apparatus was chosen, which would allow the task to be carried out without hindering the laser scanning and, from that point, it would be possible to carry out the work covering the largest possible study surface, thus avoiding having to change its position. Particularly in this study, the tide level had to be considered due to the location of the slope, close to the harbour water.



*Figure 4. 18 Laser scanner in action at the Connolly Street slope, Cobh*

The position of the laser scanner was established at the two interquartile points- the total slope length being 284 metres and the scanner placed 71 metres from the beginning and 71 metres from the end. The laser scanner interface was used to establish the distance from the slope with which the laser scanner was positioned to include the total area of the slope to be scanned. This point was marked for future scans. From these points, two separate scans of the slope were complete resulting in two-point clouds. The Cyclone 3DR software was then able to use the two separate point clouds and the overlapping areas to establish a single point cloud of the whole slope.

Once the laser positioning site was established, setting up a new project with the Leica MS60 was very intuitive. The first step, as mentioned, was to enter the points obtained from the GPS, which were used for the resection carried out with the laser scanner. This allows data to be read from a USB memory stick, which facilitates the task. Then,



through the screen that incorporates the laser, a folder was created for each wall and slope scanned, in order to obtain the point cloud of each one of them in an orderly manner. The type of scanning carried out was based on a polygonal section, i.e. the points of the slope to be scanned could be selected through the laser's target camera, resulting in a section drawn on the surface of the slope. As a last step, the desired number of points per second was selected. This depends on the level of detail to be obtained depending on the state of the infrastructure. Depending on the size of the project and the surface to be scanned, scanning times can vary considerably. For this task at Connolly Street it took just over an hour to complete the task.

#### *4.2.1.1 Laser Scanner Data Processing*

The analysis of the data obtained from the Leica MS60 laser scanner was carried out in this research project using Leica Geosystems' Cyclone 3DR analysis software (93). This allowed the transformation of the obtained point cloud into an analytical BIM model.

Cyclone 3DR merges Jetstream technology, which enables centralised full-scale point cloud management with automated point cloud and model analysis. It is a simple workflow-based software, which adapts to different tools in the field of surveying, construction and inspection. It simplifies tasks whereby it allows for the removal of data considered not relevant to the project from the point cloud or mesh. Finally, it allows full interoperability with the most common design formats, including IFC and Revit model files, as well as time-saving functions such as sending to AutoCAD or sending to Hexagon Mine Plan.

Once the laser data has been obtained, it is stored in compressed files containing all the data provided by the laser scanner. Prior processing of the images of elements considered not relevant to the study was required for this study. As a result, a point cloud of each of the elements scanned with the laser was obtained. Some of these point clouds showed the vegetation present on the structures, elements of urban furniture or cars. In order to avoid distorting the analysis and the creation of meshes, the elimination of all these elements external to the object of study was chosen.

Therefore, meshing was an important requirement in the processing of the point clouds, as they would serve as the basis for the measurement and deflection analyses of the

structures. The advantage of using this software is the visualisation of data and the easy interpretation of the results.

A major point of analysis of the software is the possibility to superimpose two meshes and to underline the points where the structure has undergone changes. These changes, such as cracks or fissures, allow to be measured regardless of how small they may be. These are an early indicator for early intervention.

Finally, the result was a 3D object-oriented model that would serve as a basis for visualising the movements of the sensors by means of a marker.

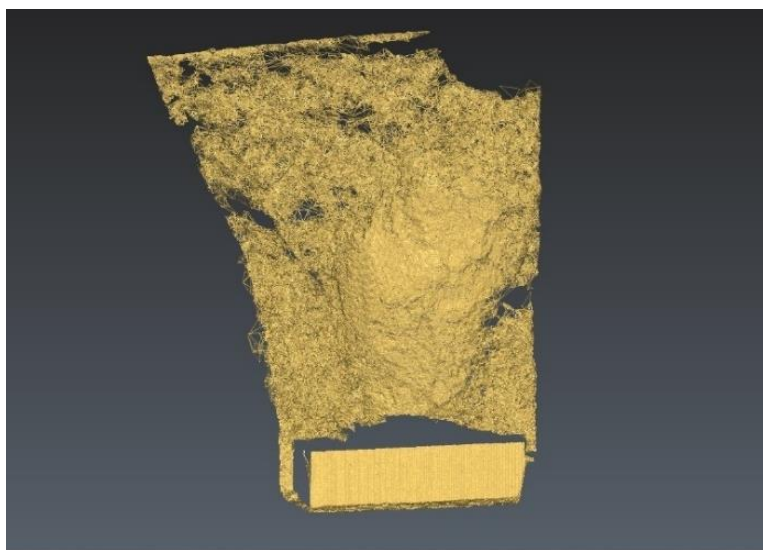

*Figure 4. 19 Point cloud resulting from the laser scan of the Connolly Street slope*

At the time of initial scanning, the level was of vegetation was seen throughout the slope. Further scans at different intervals revealed different levels of vegetation, depending on the time of year. The software was able to clean the scan of vegetations however this impacts the quality of the resulting point cloud. It can be concluded that the scan should ideally be carried out at a stage where the vegetation is at its lowest to enable the highest quality point clouds resulting in more accurate results.

#### 4.2.2 Drone Surveying methodology

The model chosen to carry out the inspections on the Connolly Street slope was the DJI Inspire 2. This drone is made of magnesium and aluminium, which makes it very light and agile. The quadcopter features a sensing vision system, as well as a three-axis camera with integrated gyro supports. The Inspire 2 is also equipped with dual batteries, which ensures adequate battery life for extensive long duration flights. Furthermore, it has an integrated battery heating system, which allows work to be carried out at very low temperatures without affecting the drone.

The main features of the DJI Inspire 2 include:

- Remote control range of 3.5 km at 2.4 GHz and 2 km at 5.8 GHz.
- The maximum speed of 94 km/h.
- Flight times between 25-30 minutes, depending on the camera used.
- The maximum resolution of videos is 5.2K.
- Equipped with two sensors for obstacle detection at a distance of 30 metres.
- Real-time 1080p video transmission

##### 4.2.2.1 Drone Processing data

Through the use of the application Pix4DCapture, a drone flight was carried out over the Connolly Street slope. This is an application (94) linked to the drone that allows the creation of a programmed flight-map providing optimal points of photographing with the flight settings being reproducible. The images generated through this software can then be transferred and processed for the development of a 3D point cloud.

The Pix4DCapture software was developed in a manner that is user friendly and straight forward in its layout without requiring in-depth prior knowledge and enables predetermined drone flight routes. The three-step process is guided by the software. Following the selection of the flight type, the user adjusts the drone flight plan and parameters customizing mapping parameters through aerial images of the area to be surveyed.

The flights over the Connolly Street slope were carried out using the "double grid" option offered by the Pix4DCapture application software. This was chosen based on the end result desired as well as the parameters of the slope and surround structures. The

alternative flight options were not suitable to this project as they either offered 2D models or required the object being surveyed to be free standing allowing the drone to



Figure 4. 20 Selection of the area to be flown by the drone over the Connolly Street slope, Cobh

circulate around it entirely. The 'double grid' option consists of a grid placed over the surface to be flown, where the drone performs the flight and takes the necessary photographs according to the size of the surface. The drone flies along the grid lines in an orderly fashion. There are two superimposed grids in order to guarantee a complete flight from all perspectives to the chosen surface.

#### 4.2.2.2 Drone flight area

The result of the drone flight is a file containing the photographs taken during the task. The number of photographs varies depending on the size of the surface to be flown. The flight over the slope at Connolly Street involved a total of 22 photographs. The processing of the information resulting from the flight is carried out using Pix4DMapper software. This is a photogrammetry software that uses the images to generate a point cloud, digital surface and terrain models, orthomosaics and textured models (95).

First, the photographs obtained during the flight must be loaded into the software. The software starts by reading the data as a first step and then, as a second step, generates the point cloud and the mesh. This is done through the identification and matching of

key points within the images. Combining this information with camera model optimization and geolocation GPS information allows for 'Automatic Tie Points'. The software then builds on the 'Automatic Tie Points' using point densification to create a 'Densified Point Cloud' followed by a 3D textured mesh. This 3D textured mesh, along with the sensors forms an integral part of the early warning system for slope activity.

However, the interoperability of Pix4DMapper can limit the export of the files to other software such as Revit. For this reason, in order to be able to export the point cloud to Revit in .PTS format, the images obtained from the drone flight were then processed using Recap Pro, allowing for the export to Revit in .PTS format. In doing so, information loss was prevented with the point clouds being of high quality.



*Figure 4. 21 Photogrammetry points collected by the drone*

As a result of the drone flight, aerial photographs were obtained, which were processed through ReCap Pro, to capture from the resulting photographs a high-quality detailed 3D object-oriented model. A point cloud was used to generate a mesh on top of the resulting model. This mesh allowed for different measurements of the point cloud such as depth of surface indentations, point number density, deflections, among other measurements.

In addition, the file could be saved in four different formats such as RCP, RCS, PTS and e57, which allowed full compatibility with other modelling and analysis software such as Revit or ReCap Photo. Prior to exporting the file, it was possible to choose the point

density of the cloud with which the document was to be exported. According to the type of modelling or analysis to be applied later, this would require a higher or lower quality of the file. For the study on the Connolly Street slope, an RCP file export was chosen, with a density of 100 points per square metre. This proved satisfactory for the modelling to be developed in Revit. It is worth mentioning that the file export is only of the point cloud and not of the generated mesh, as this is only a visualisation of the software.

Currently Revit has plugins that allow for the generation of meshes on topographic surfaces, nevertheless, it cannot process meshes where there are several points on the same coordinate axis. Revit is a popular and commonly used tool for structural surveying, therefore, its use on complex topographic surfaces is limited. This study provides a solution to overcome these challenges by combining Revit with Dynamo. Through the use of Dynamo, an ordered node geometry is used to triangulate surfaces. The open3d package is used to scan the points by proximity and the Numpy package generates arrays to create the mesh.

#### 4.3 Real-time Sensors Data Collection

In recent years, sensor technology has evolved exponentially, leading to the implementation of sensors in structural health monitoring systems in all types of civil structures. There is a great diversity of sensor types, from wired to wireless sensors. One of the main advantages offered by the use of sensors in structural health systems is the collection of real-time data, which allows continuous monitoring of the infrastructures under study.

The main basis of structural health monitoring is the compilation of data, or measurements, that are required to be accurate and high quality in their results, and it is the sensors that are the protagonists in the process of data collection and measurement. They are designed to streamline the process and provide subject matter experts with an effective tool that will be essential in making decisions and ensuring safety.

The structural health monitoring task is typically comprised of a network of sensors, which are responsible for measuring the indicated parameters and sending this data to

be stored and then analysed. These monitoring studies can measure parameters such as vibration, temperature, humidity, expansion, movement, deformation and tilt.

Realtime sensing on this project was focussed on the Connolly Street slope in Cobh.

#### 4.3.1 Sensor Network Design

A sensor network to monitor the slope movement was designed using accelerometers. The market offers a wide variety of accelerometers, all of which perform their functions perfectly, but for this project it was initially decided to limit the study to one type of accelerometer and gyroscope model MPU 6050. Accelerometers were used for the monitoring of the slope in this research as they are more efficient and cost effective in comparison to other sensors as well as the added benefit of ease of coding the sensor. The data extracted from accelerometers is easy to interpret and can be integrated to a 3-D orientated model easier when compared to other sensors types such as barometers.

The accelerometer is a sensor capable of measuring acceleration forces in single or multi-axis directions. The forces can be static, such as the force of gravity exerted on a structural component, or dynamic if it is the detection of motion or vibration. An accelerometer itself has the ability to measure the orientation of a fixed platform relative to the earth's surface, while a gyroscope has the ability to measure gravity and linear motion. For this reason, the monitoring carried out on the Connolly Street slope was performed with accelerometers and gyroscopes, in order to measure the orientation through angular momentum (gyroscope) and the vibration that could be produced (accelerometer). This sensor network is non-intrusive and can be extended and applied to masonry walls and other structures requiring monitoring.

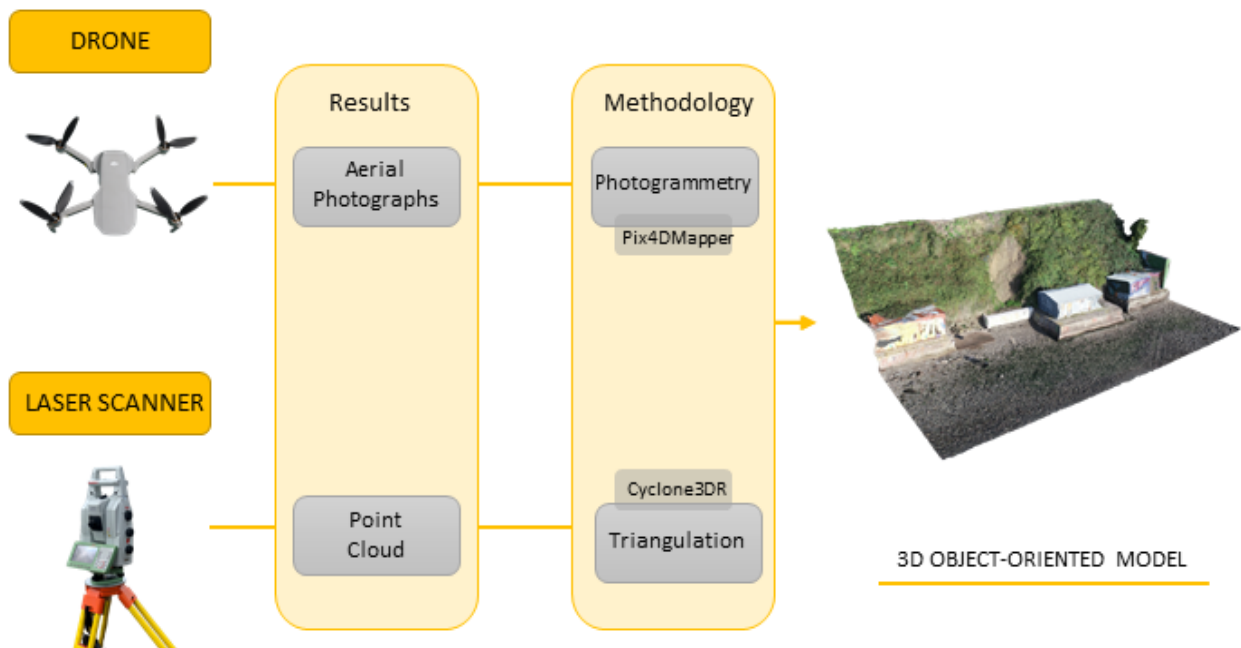

Figure 4. 22 Overview of Topographic Data Collection

#### 4.3.2 Sensors

Arduino offers a wide range of boards that can be used for an infinite number of projects. Given that the aim of monitoring the Connolly St. slope was to receive data in real time and remotely, it was decided to use the sensor on an Arduino Uno WiFi board, which allows connection to the internet via its ECC608 chip.



Figure 4. 23 Arduino Uno WiFi Rev2 (20)

This sensor features an 8-bit microprocessor from Microchip plus an integrated IMU (Inertial Measurement Unit).



The Arduino Uno WiFi has 14 digital input and output pins, 6 analogue inputs, USB connection, power connector, ICSP header and a reset button. Further technical characteristics can be seen in Appendix 1.

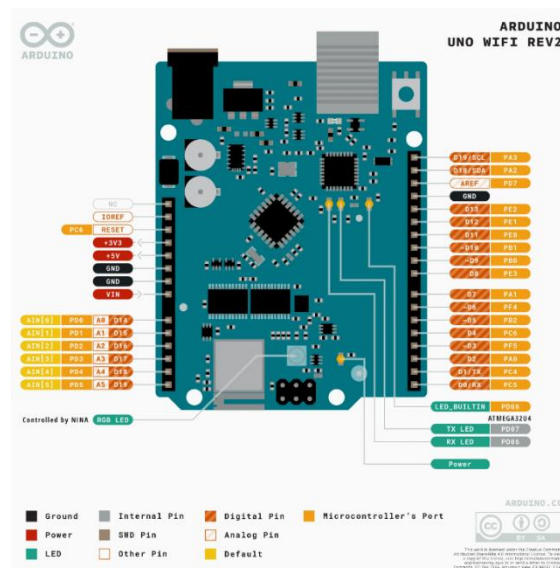

Figure 4. 24 Arduino Uno WiFi Rev2 components (20)

#### 4.3.3 Inertial measurement sensor

The MPU6050 sensor is a 6 degrees of freedom inertial measurement unit (IMU), given its combination of 3-axis accelerometer and 3-axis gyroscope.

This sensor model is commonly used in navigation, stabilisation and short-time motion measurement project.

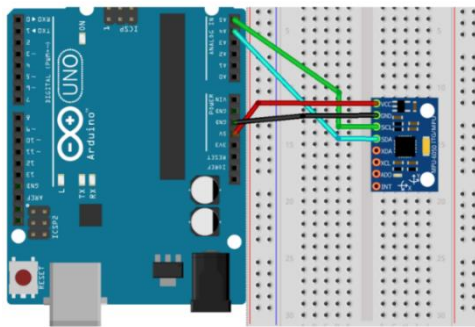

Figure 4. 25 Inertial measurement sensor (20)

Technical characteristics;

- I2C communication, which allows it to work with the vast majority of microcontrollers.
- SCL and SDA pins, with pull-up resistor for direct connection to the microcontroller.
- 3.3V on-board voltage regulator, which can be powered by 5V from the Arduino.

MPU 6050 is then connected to the Arduino board;



*Figure 4. 26 Connection Inertial measurement sensor to Arduino Uno WiFi (20)*

#### 4.3.4 Wireless connectivity

To establish a connection between sensor and data receiver, a Mobile WiFi was used. This is a device that allows sharing the mobile internet connection with several devices. It receives a 3G/4G signal and shares it via a WiFi signal, allowing it to be shared with several devices at the same time.



*Figure 4. 27 Wireless connectivity (21)*

The chosen model has an internal lithium battery of 1500mAh. This allows a maximum working time of approximately 6 hours and a maximum of 300 hours when in standby

mode. To avoid connection loss due to the modem battery, for this project we chose to power the modem with a Belkin 20K external battery, which allowed us to extend the modem's battery life.

#### 4.3.5 Sensor storage

In the case of disconnection via WiFi between sensor and receiver, it was decided to add the SD Card Shield to the Arduino Uno WiFi board, in order to avoid data loss in the event of failure. This particular model allows a quick connection to the Arduino board without the need to use jumpers and breadboard.



Figure 4. 28 Sensor storage (20)

To read out the acceleration and angular momentum data from the sensor, programming was carried out on the Arduino. The fundamental basis of the programming was the calculation of the sensor displacement.

The principle of operation of the MPU6050 accelerometer is based on the variation of the velocity per unit of time;

#### Equation 1 Acceleration

$$a = \frac{dV}{dt}$$

As Newton's second law states, the acceleration of a body is always proportional to the force acting on it, provided that the body has a constant mass;

#### Equation 2 Force and acceleration

$$a = \frac{F}{m}$$

The accelerometer contains a MEMS (Microelectromechanical System) that works similar to a spring-mass system, thus being able to measure acceleration.

For this project, the possible displacements of the sensor on the slope surface were required. To obtain this value, the acceleration had to be integrated with time, giving the velocity, and the integration of the velocity would give the displacement. For these, the velocity and the initial position were needed.

In order to obtain the angular displacement of the sensor, the angular velocity provided by the gyroscope was considered;

*Equation 3 Angular velocity*

$$\omega = \frac{2\pi}{T}$$

Once the angular velocity of the sensor was obtained, it was integrated with respect to time in order to obtain the angular displacement of the sensor.

In this way, the information obtained from the sensor, reflected in an Excel sheet, was the possible movements of the sensor in the X, Y, and Z axes.

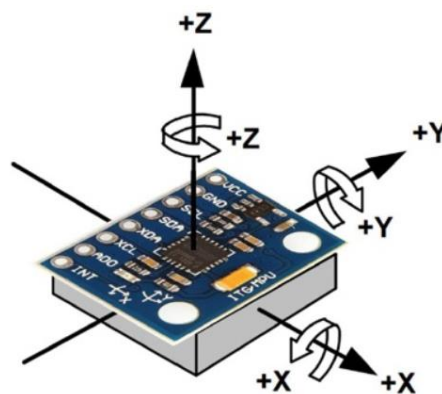

*Figure 4. 29 Sensor measurement axes (22)*

#### 4.3.6 Sensor programming

The procedure followed for writing the coding of the sensor and its connections is explained below. The steps followed in programming the sensor were:

- Libraries and Time Intervals
- 4G Modem and Google Sheet connection
- Storage on the SD card

- WiFi connection and SD card
- Sending and writing data to Google sheet

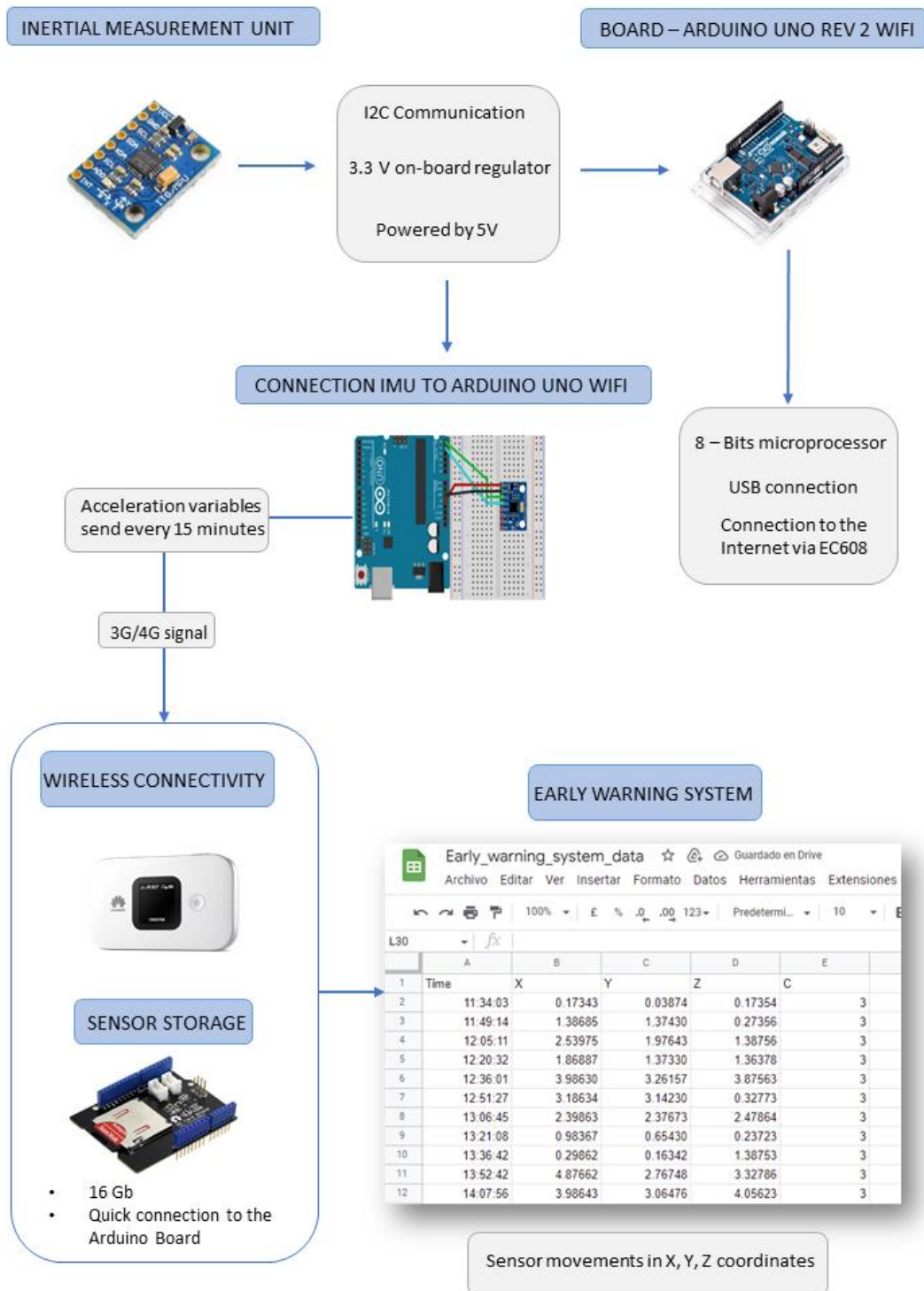

Figure 4. 30 Overview of the sensor network design

#### 4.3.6.1 Libraries

Firstly, the specific libraries of each element that make up the sensor were included. In this case, the libraries belonging to the sensor model MPU 6050, internet connection and data storage on the SD card had to be included. The libraries for each of these components was obtained through the Arduino software.

Next, the variables for the connection of the MPU 6050 sensor were established, as well as the time interval required by the project to send data to the spreadsheet. Of note, for this study, an interval of 900,000 milliseconds, i.e. 15 minutes, was established. The interval of 900,000 milliseconds was used as it provided accurate slope structural information whilst also prolonging the battery life of the sensor. Similarly, the reading of the variables provided by the sensor, i.e. acceleration and gyroscope in the three axes, had to be included.

```
#include <MPU6050.h>
#include <WiFiNINA.h>
#include <SD.h>
#include <Wire.h>

//MPU-6050 variables
MPU6050 mpu;
unsigned int zero_time = millis(); //Initialise timestamp
float lastMeasureTime;
float lastStreamTime = 0; //To store the last streamed time stamp
const int streamPeriod = 900000; //To stream at 15 minute intervals
float accx, accy, accz, x = 0, y = 0, z = 0, H, R, P; //Variables to store acceleration
int16_t ax, ay, az;
int16_t gx, gy, gz;
```

Figure 4. 31 Libraries Code

#### 4.3.6.2 4G Modem and Google Sheet connection

Next, the connection between the Arduino Uno WiFi and the 4G Modem was established. Concurrently, the connection between the sensor and the recipient was made. Therefore, the Google Sheet link was created in order to establish the connection between the two elements.

```
//WiFi variables
const char ssid[] = "HUAWEI_E5577_809D"; //Slightly modified Wi-Fi modem SSID
const char pass[] = "RER9331TMDY"; //Slightly modified Wi-Fi modem password
int status = WL_IDLE_STATUS;

int HTTP_PORT = 443;
String HTTP_METHOD = "GET ";
char HOST_NAME[] = "script.google.com"; // hostname of web server:
String PATH_NAME = "/macros/s/AKfycbxw45vMgPF0C9TJz0Jvw6lZoMtovekQ8hICTKNW_3o0D8KwhZAJ1CEBdEM T6PC_V/exec";
String HTTPS_FINGERPRINT = " 82a916759d9d1034ee1427a65a09992d53f4";
WiFiSSLClient client;
```

Figure 4. 32 Modem and Google Sheet connection code

#### 4.3.6.3 SD card storage

As indicated above, although the sensor sends the accelerometer and gyroscope data every 15 minutes to the datasheet, it was decided to incorporate an SD card in the sensor in order to safeguard the data in case of failure in the data transmission or connection via WiFi.

```
//SD Card variables
const int chipSelect = 4;
String FILE_NAME = "Data.tsv";
```

Figure 4. 33 SD card storage code

#### 4.3.6.4 WiFi and SD card connection

For a period of ten seconds, the sensor's WiFi module checks and verifies that the connection established is satisfactory. Through the experimental varying of the connection verification, it was established that ten seconds was the minimum time required to establish a satisfactory connection and so this time interval was applied to the WiFi module.

Also, during the same time interval, the connection to the SD memory card is verified and once confirmed, it displays the indicated verification message.

```
//WiFi connection
while (status != WL_CONNECTED) {
  Serial.print("Attempting to connect to Network named: ");
  Serial.println(ssid);
  status = WiFi.begin(ssid, pass);
  for (int i = 0; i < 10; i++) {
    Serial.print(String(10 - i, DEC) + "...");
    delay(1000);
  }
  Serial.println();
  Serial.print("SSID: ");
  Serial.println(WiFi.SSID());
  IPAddress ip = WiFi.localIP();
  IPAddress gateway = WiFi.gatewayIP();
  Serial.print("IP Address: ");
  Serial.println(ip);

  //Initialising SD card
  Serial.println("Initializing SD card...");

  // see if the card is present and can be initialized:
  if (!SD.begin(chipSelect)) {
    while (!SD.begin(chipSelect)) {
      Serial.println("Card failed, or not present");
      Serial.print("Retrying in ");
      // Wait for correction:
      for (int i = 0; i < 10; i++) {
        Serial.print(String(10 - i, DEC) + "...");
        delay(1000);
      }
      Serial.println("");
    }
  }
  Serial.println("Card initialized.");

  Serial.println("Thank you for waiting. Sensor is operational.");
}
```

Figure 4. 34 WiFi and SD card connection code

#### 4.3.6.5 Sending and reading data

Once all connections have been established and verified, the information to be read from the Google Sheet is determined. To do this, the connection to the server is requested and the sequence of data and the way in which they will be displayed in the data sheet is determined. In this case, the data sheet shows the three coordinates (X, Y, Z) as well as the calibration status of the sensor C, which can vary between 0 and 3, 3 being the value of correct calibration.

The data received through google sheets is then incorporated into Dynamo, along with the mesh created from the drone images, to form the early warning system.

```
void sendData(float X, float Y, float Z) {
    String string_x = String(X, DEC);
    String string_y = String(Y, DEC);
    String string_z = String(Z, DEC);
    String string_c = "3";
    String queryString = String("?X=") + string_x + String("&Y=") + string_y + String("&Z=") + string_z + String("&C=") + string_c;
    //Serial.println(queryString);

    if (client.connectSSL(HOST_NAME, HTTP_PORT)) {
        Serial.println("Connected to server");
        client.println(HTTP_METHOD + PATH_NAME + queryString + " HTTP/1.1");
        client.println("Host: " + String(HOST_NAME));
        Serial.println("Request sent");
    } else {
        Serial.println("connection failed");
    }

    if (!client.connected()) {
        // if the server's disconnected, stop the client:
        Serial.println("disconnected");
        client.stop();
    }

    while (client.available()) {
        char c = client.read();
        Serial.write(c);
    }

    client.println("Connection: close");
    client.println();

    if (!client.connected()) {
        // if the server's disconnected, stop the client:
        Serial.println("disconnected");
        client.stop();
    }
}

void writesddata(float X, float Y, float Z) {
    // open the file. note that only one file can be open at a time,
    // so you have to close this one before opening another.
    File dataFile = SD.open(FILE_NAME, FILE_WRITE);
    String string_t = timestamp();
    String string_x = String(X, DEC);
    String string_y = String(Y, DEC);
    String string_z = String(Z, DEC);
    String dataString = string_t + "\t" + string_x + "\t" + string_y + "\t" + string_z;
    // if the file is available, write to it:
    if (dataFile) {
        dataFile.println(dataString);
        dataFile.close();
        // print to the serial port too:
        Serial.println(dataString);
    }
    // if the file isn't open, pop up an error:
    else {
        Serial.println("error opening " + FILE_NAME);
    }
}
```

Figure 4. 35 Sending and Reading data code



#### 4.3.7 Field Deployment;

For the monitoring of the Connolly Street slope, it was decided to mount and programme the above-mentioned sensors based on the reliability of the results. In addition, for a correct monitoring of the structural health, in this case of an earth slope, it was possible to dispense the traditional methods, which are complex to carry out, less precise and with a high economic cost. Likewise, this type of monitoring through sensors avoided having to carry out invasive tests or monitoring procedures on the slope, which would have put the stability of the slope at risk and increased the possibility of landslides.

Unlike the traditional methodology used for retaining wall and slope monitoring, the sensors allowed continuous, real-time results to be obtained. It was possible to take the monitoring further, and this led to the creation of an early warning system, which provided information on the state of health of the slope in a simple way.

The sensor designed for monitoring is housed in a small, lightweight, weatherproof box. This allowed the sensor to be placed on the slope surface without affecting its stability. In addition, to extend the monitoring study, the sensor could be moved along the slope surface to study its behaviour at different points along the study or furthermore, a larger number of sensors could be deployed to simultaneously monitor the slope at different locations. The under surface of the sensor box was constructed with studded plastic to anchor, superficially, the sensor to the slope surface and therefore prevent any interference by weather events such as heavy rain or strong winds. Through this mechanism, damage to the slope surface during the deployment of the sensor is avoided as the integrity of the slope surface is not affected.



Figure 4. 36 Sensor box applied to the Connolly Street slope



Figure 4. 37 Waterproof sensor case

Once the sensor is placed on the slope, it starts to take readings of any possible movement on the slope, which will be reflected in the X, Y and Z coordinates. These readings are sent to a Google Sheet every 15 minutes. Google Sheet was used as a database for this research due to the ease in connectivity. As Google Sheet is a web application, it is easily connected to the sensor through the WiFi to enable live data to be recorded continuously. Furthermore, the Google Sheet is easily accessible from multiple devices and also, the data relayed from the sensor is clearly recorded for ease in interpretation. The time interval of data sending can be adapted to the demand of the project. It was decided to send the data every 15 minutes as this met the requirements of the study whereby the balance between the level of information provided was accurate whilst the interval of data reading was long enough that didn't require intense power and so prolonged the sensor battery life.



*Figure 4. 39 Sensor deployment on Connolly Street slope, Cobh*



*Figure 4. 38 Sensor deployment on Connolly Street slope, Cobh*

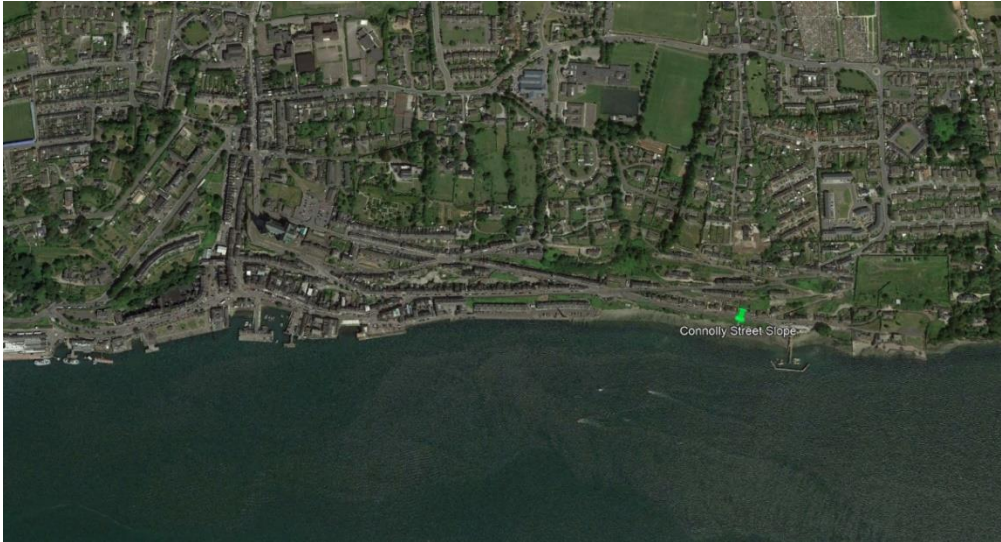

*Figure 4. 40 Aerial view of the location of the Connolly Street slope at Cobh*

#### 4.4 SHM integration with BIM platform

Using the data collected through the sensors as well as the drone or laser scanner, this chapter explains how this information is integrated into BIM and how the information is treated and integrated into a single model. Thereby, through the sensor data an early warning system will be created, which consists of a marker on a 3D object-oriented model of the slope, indicating any possible movement on the slope surface in real time.

A state-of-the-art structural health management tool is thus designed, which helps to visualise in real time the monitoring of the element under study. It also helps to reduce monitoring and maintenance costs by identifying early intervention requirements.

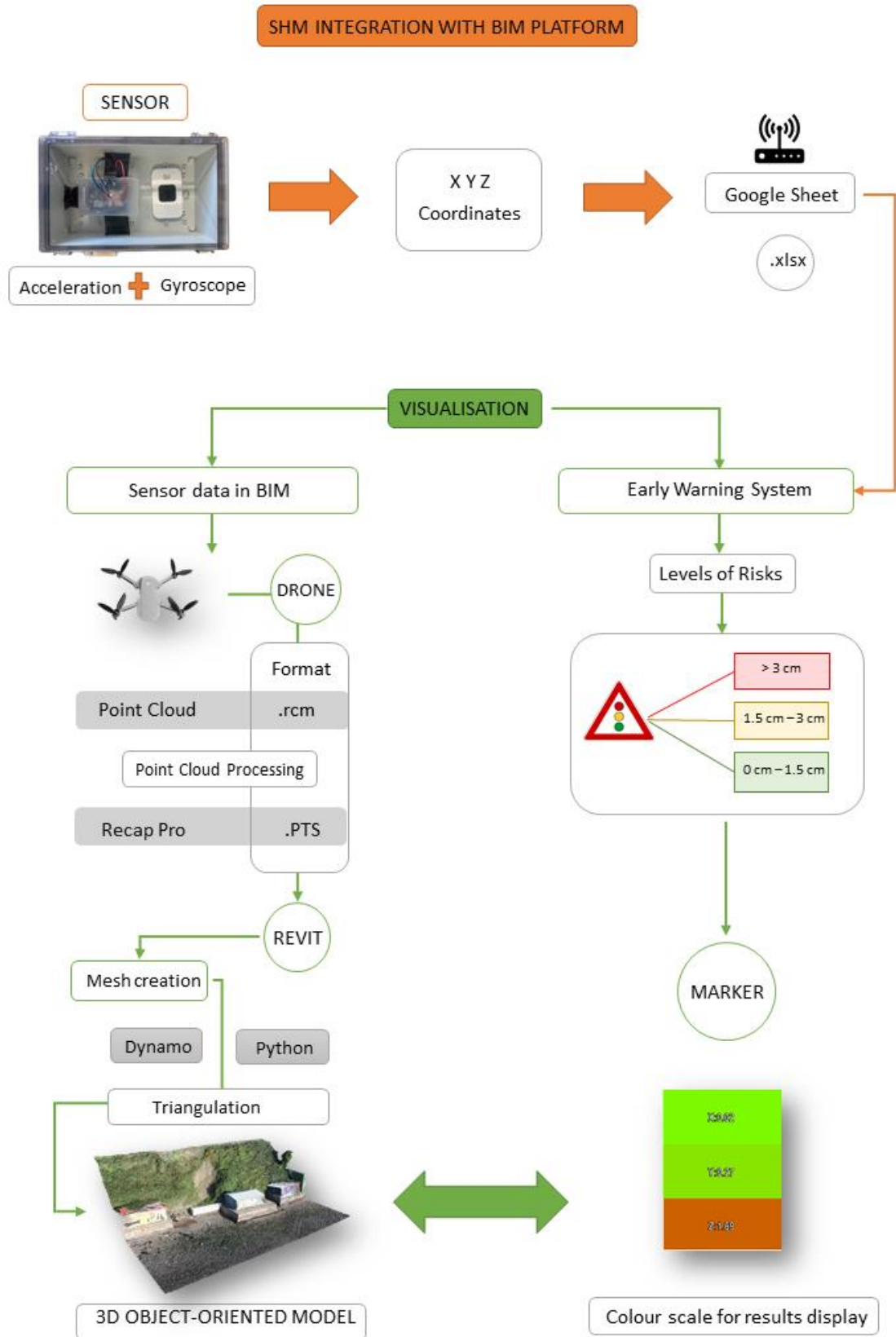

Figure 4. 41 Overview of SHM integration and format transfer

#### 4.4.1 Early warning methodology

The purpose of this study was to highlight the versatility and usefulness of sensors in the process of developing an early warning system for geostructures damage and destruction. Following the coding and development of the sensor, it was applied in different manners to display its usefulness and relevance. To this end, the data capture methodology is structured in three different levels, based on the degree of movement. For the purpose of this research project, three levels of warning were used for ease of interpretation of the results. The traffic light system was implemented according to the degree of damage to clearly identify the slope surface changes. Depending on the accuracy of diagnosis required, more levels could be incorporated to the early warning system to identify movements at different intervals.

##### 4.4.1.1 Level 0

This level collects sensor data when the data indicates a static state. When the data collected is close to zero, the data would be categorised as level 0 data. Therefore, when the data is between 0.01 and 1.5 centimetres, it would be considered as "practically static". This was the standard behaviour of the slope, where the data are considered to be of low relevance to the early warning system and displaying very little changes in the slope over time.

##### 4.4.1.2 Level 1

When the data received from the sensor ranged between the values of 1.5 and 3 centimetres, they were contained in Level 1 indicating an intermediate level of warning. A simulation of sensor movement was carried out to display the behaviour of the early warning system in the event of level 1 data as well as to assess the accuracy of the sensor in intermediate degrees of movement. The interval of 1.5 to 3 centimetres was used as this research project intended to identify early signs of slope surface movements instead of larger changes. Through the use of smaller measurements of movement, minor changes in the slope surface over time could be observed and recorded therefore identifying the rate in which the slope is at risk of collapse for early preventative interventions. This interval is easily modified according to the requirements of the slope or retaining wall.

#### 4.4.1.3 Level 2

Level 2 data indicates extreme levels of sensor movement as is expected from events such as landslides. This data results from movements of greater than 3 centimetres. The sensor was again moved in an extreme movement with close surveillance of the data received showing its effect on the early warning system.

Furthermore, these levels of sensor movement classification could be applied and exported to any other structure. The range of sensitivity applied at each level is adapted to the type of structure and type of damage to be studied.

In addition, the design of the coding for the early warning system was designed to be adaptable to other studies on different structures, being able to modify the parameter of the sensitivity of movement for the accurate classification in the corresponding levels

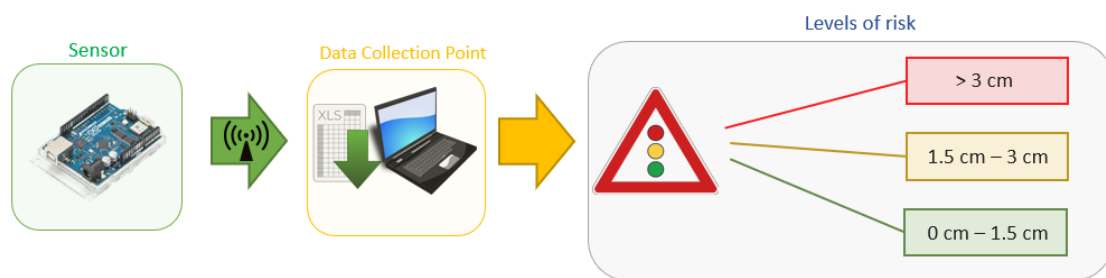

Figure 4. 42 Overview of Sensor Data Collection and study levels

#### 4.5 Visualisation of sensor data in BIM

The information collected by the sensor is sent to the Google Sheet every 15 minutes, so in order to visualise the information in real time, the marker created in Dynamo must periodically read the code created. With this, it is possible to keep the Revit model continuously updated, without having to run Dynamo, as it will be done automatically every 15 seconds

##### 4.5.1 Programming requirements;

The version of Revit installed at the time of this study was Revit 2022, which already incorporates Dynamo, without the need to install it externally. This works in conjunction with Revit as another software plugin.

In addition, Python version 3.8 had to be installed. Python is a programming software based on an interpreted language, without the need for compilation for its execution,

these are carried out directly by the computer through a program called interpreter. Its language is easy to read and write, it also has an open source multiplatform, allowing the software to be developed without any kind of limit.

Once the software was downloaded, the necessary libraries for coding were downloaded, such as;

*Table 4 Dynamo coding library*

<b>Python NumPy (96)</b>	Used for the programming language, through which large multidimensional vectors and matrices can be generated, as well as high-level mathematical functions.
<b>Open3D (97)</b>	Open Source library for 3D data processing.
<b>MatPLOLib (98)</b>	Library needed to create graphs from data contained in lists.
<b>Oauth2client (99)</b>	Allows to establish the connection between different servers.
<b>Gspread (100)</b>	Library which gives access to the interaction with Google spreadsheets.

Once all the Python libraries are installed, the programming in Dynamo can begin.

#### 4.5.2 Visual Programming

The step by step process in the development of the programming designed for the Conolly Street slope in Dynamo is shown below.

##### 4.5.2.1 Mesh creation

Firstly, a mesh was created using the existing point cloud generated through the drone images and ReCap. Due to the limitations of Revit for mesh creation, this research developed how to generate a mesh through a point cloud and visualise it in Revit. Therefore, this would help in future projects, to visualise the real movement of the slope surface if working with a sensor network, which would operate connected to the Revit

mesh. Furthermore, this project does not seek to visualise the movement of the sensor on the point cloud or slope surface, but rather the creation of the warning system by means of colour codes indicating the level of movement of the slope. The visualisation of the sensor's movement would entail a significant increase in the system's performance, as the software must update each movement in a cloud made up of several million points (depending on the surface to be worked with). However, and with a view to a future project annexed to the current one, the performance of the software would be optimised if it worked on a mesh instead of on a cloud of points, as well as providing a more precise and optimal result due to the triangulation already formed.

The mesh is a set of ordered points, however, the point geometry used in this project was not. It was decided to create a mesh in Dynamo, which allowed for work to be done with an ordered geometry. For this, as the order was not known and the mesh of points were not ordered, an auto-ordering algorithm had to be used, in this case by proximity, which was based on triangulation for the creation of the mesh by joining the points in groups of three that are closest to each other. This process was possible with Revit, as it has a surface generation algorithm integrated in the topography creation node. However, topographies in Revit do not support points in the same XY position, but with different Z position.

The final resulting mesh depends on the triangulation algorithm used and may vary depending on which one is used. Through trial and error, several algorithms have been tested for the creation of the mesh of the Connolly Street slope. Through Open3D, the resulting algorithm was able to scan the points created, from the drone, by proximity to formulate arrays (grouping of objects of the same type). Another coding algorithm, Numpy, is then used to analyse these arrays to create the mesh. The Python node script in Dynamo works with an input from a .PTS point cloud and returns the points in the form in which it is needed in Dynamo's Mesh node.



#### 4.5.2.2 Programming scheme

The points that follow the programming development in the creation of the mesh are the following;

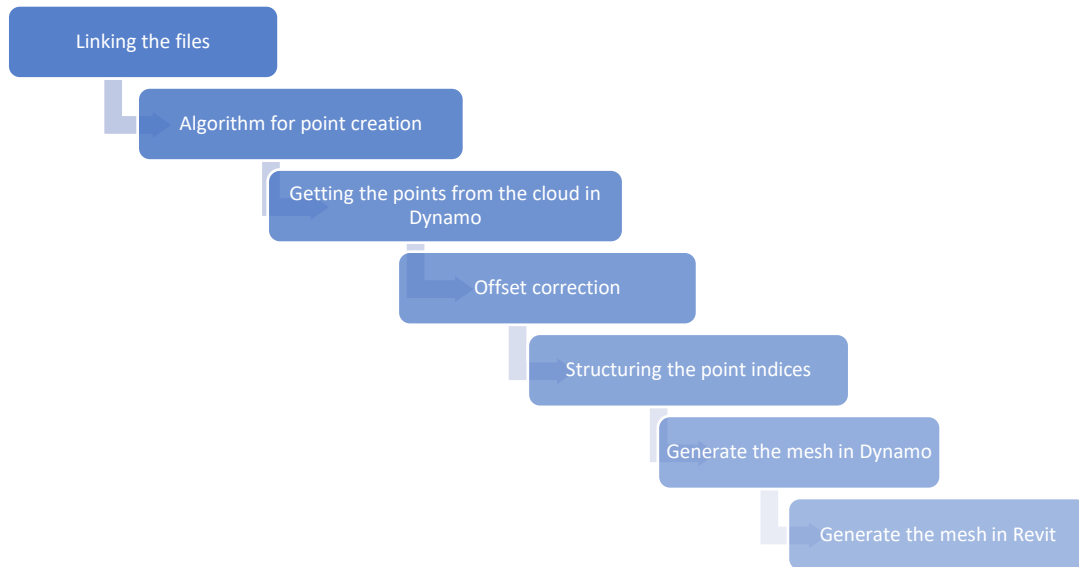

Figure 4. 43 Programming scheme for mesh creation using a point cloud to Revit through Dynamo.

The programming carried out for the development of the grid was as follows;

Through the first node "File Path", the reading of the point cloud is allowed. This is in .PTS format for the correct reading in Revit. Next, the "Point Cloud" node is used to create the script necessary for the development of the mesh in Python.

Following the input of the above-mentioned libraries into Python, the code can enable the reading of the points coming from the point cloud and by means of the generated algorithm, bases the triangulation on groups of 3 points, based on proximity. However, the resulting mesh will be an approximate mesh geometry, as it is based on points and not on an initial mesh. It will have some gaps where the reading could not be executed to generate the triangulation.

```

14 import random
15 import numpy as np
16 import open3d as o3d
17
18 import matplotlib.pyplot as plt
19
20
21 filepath=IN[0]
22
23
24 filepath=IN[0]
25 segment_models={}
26 segments={}
27 inliers={}
28 inlier_cloud={}
29
30 Outt=[]
31 Outt2=[]
32 Outt3=[]
33 dec_meshl=[]
34 max_plane_idx=1
35 point_cloud= np.loadtxt(filepath,skiprows=1)
36
37
38 #Format to open3d usable objects
39 pcd = o3d.geometry.PointCloud()
40
41 pcd.points = o3d.utility.Vector3dVector(point_cloud[:, :3])
42 pcd.colors = o3d.utility.Vector3dVector(point_cloud[:, 3:6]/255)
43 pcd.normals = o3d.utility.Vector3dVector(point_cloud[:, 6:9])
44
45 downpcd=pcd.voxel_down_sample(voxel_size=0.1)
46
47
48
49
50 labels1 = np.array(downpcd.cluster_dbSCAN(eps=0.05, min_points=10))
51 candidates1=[len(np.where(labels1==j)[0]) for j in np.unique(labels1)]
52 best_candidate1=int(np.unique(labels1)[np.where(candidates1== np.max(candidates1))[0]])
53

```

Figure 4. 44 Python script for mesh creation

Following the completion of the above, the next step is the obtaining of the points of the cloud in geometry. To do this, a Code Block is used to transform the list of point clouds into a single list of objects. It is then possible to define the coordinates of the points through Point.ByCoordinates (Figure 4.36).

The initial points generated through the Python coding are produced in an offset manner that requires correction in order to counteract the offset and make a correct reading of all the points in the cloud. This is possible through Code Block, which reads the compiled point lists, transforms them into a single object list and prepares the lists by coordinates to generate the vertex indices for the mesh, (Figure 4.37).

Finally, before the mesh can be generated in Dynamo, it is necessary to structure the indices of the points to support the creation of the mesh, (Figure 4.8).

From this point, through a single node, the creation of the mesh is ordered in the programming, first in Dynamo and finally in Revit, where the result can be visualised, (Figure 4.39).

For the creation of the mesh in Revit, the desired categories in the visualisation of the mesh must be defined. For this project, the material "Brick, Common" was used, this

being a parameter that can be changed as appropriate. Similarly, for the "DirectShape" node category, "Floor" was used. This is because the resulting mesh in Revit 2022 shows the lines of the triangulation and can only be attenuated or camouflaged by the colour applied as material. For this reason, it was decided to apply "Floor" as a category. This category allows for the elimination of the triangulation lines that are generated in the floors and therefore provides a mesh that is easier to interpret with less interference from the triangulation lines. Furthermore, for the purpose of interoperability, "floor" was selected. Further work could be focused on developing new IFC schema based around the system as per Dragos (101).

Below is an overview of how the different blocks of nodes generated in this step of the mesh creation are connected (Figure 4.40).

Upon completion of the above steps, the mesh is visible in both Dynamo and Revit. Due to the volume of point clouds with which the mesh works, Revit requires more time to process the changes. Similarly, the execution of the code in Dynamo takes longer depending on the type of computer and hard drive being used.

If it is desired to work without the mesh, this could be done through the use of software that allows for the exportation of the point cloud in the .PTS format to Revit where it is worked on with the marker that is generated as an early warning system.

The update of the data provided by the sensors is shown through a marker with a scale of values and not with movements in the point cloud or mesh itself for two reasons. First, as indicated above, the weight of the point cloud can become too large, hindering the real-time data update process, lowering the performance considerably. Secondly, the movement that could be generated in the mesh would not show the real structural behaviour of the slope, but would be a linear representation of the movement of the sensor without reflecting the real movement of the slope surface.

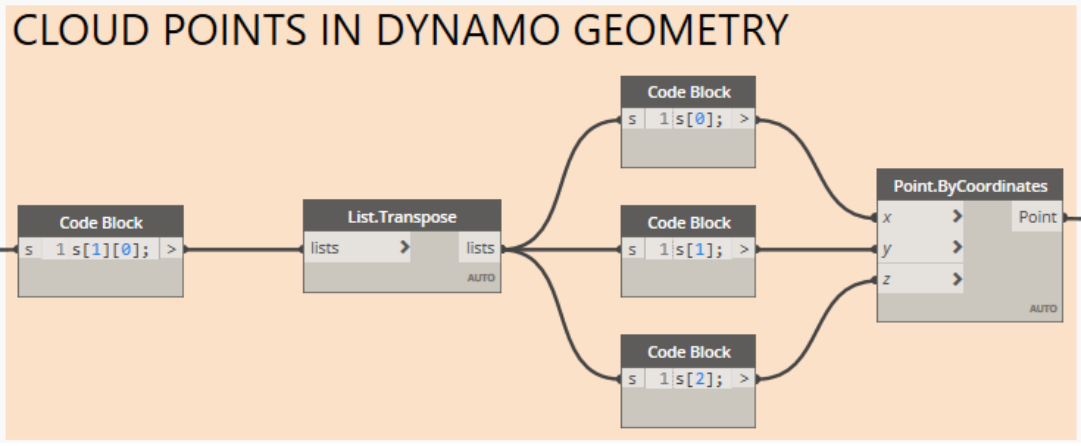

Figure 4. 45 Cloud points in Dynamo geometry

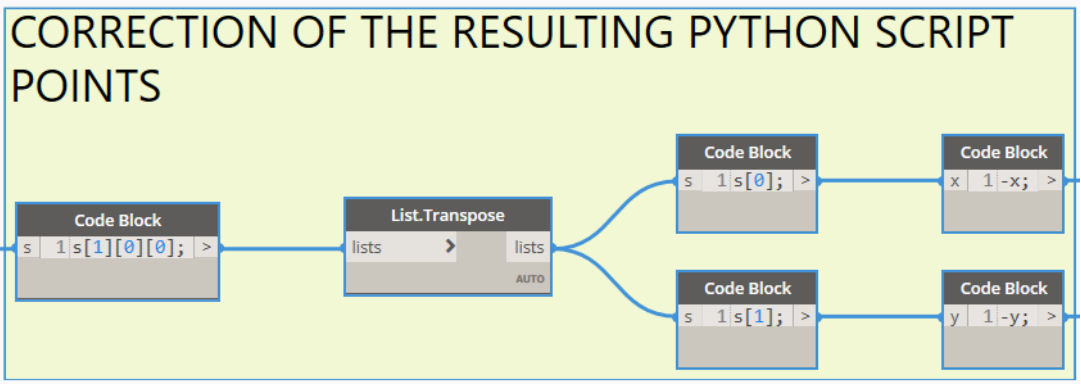

Figure 4. 46 Correction of the resulting Python script points

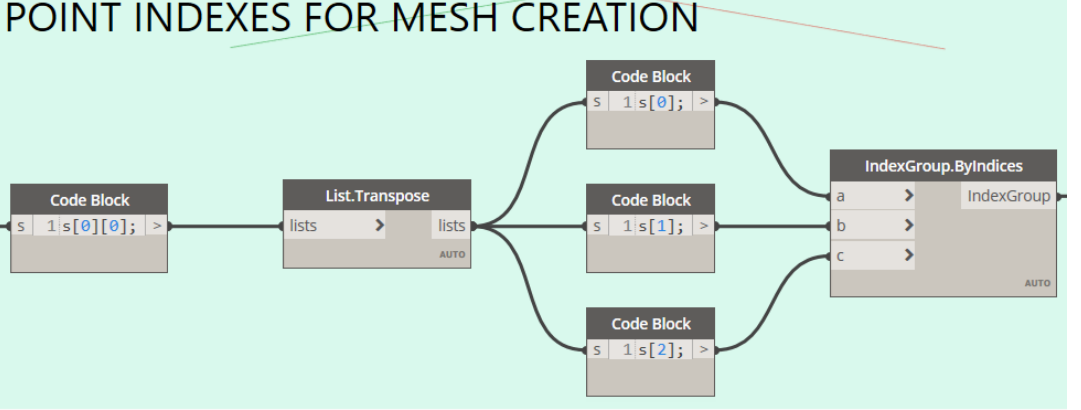

Figure 4. 47 Point indexes for mesh creation

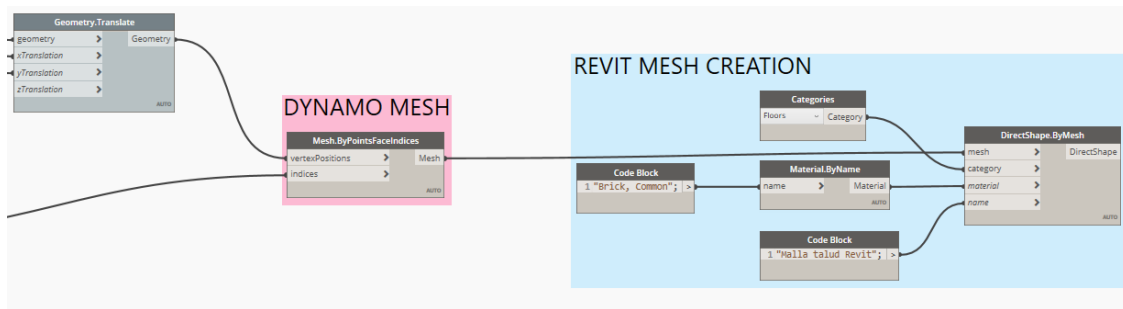

Figure 4. 48 Mesh visualisation in Revit

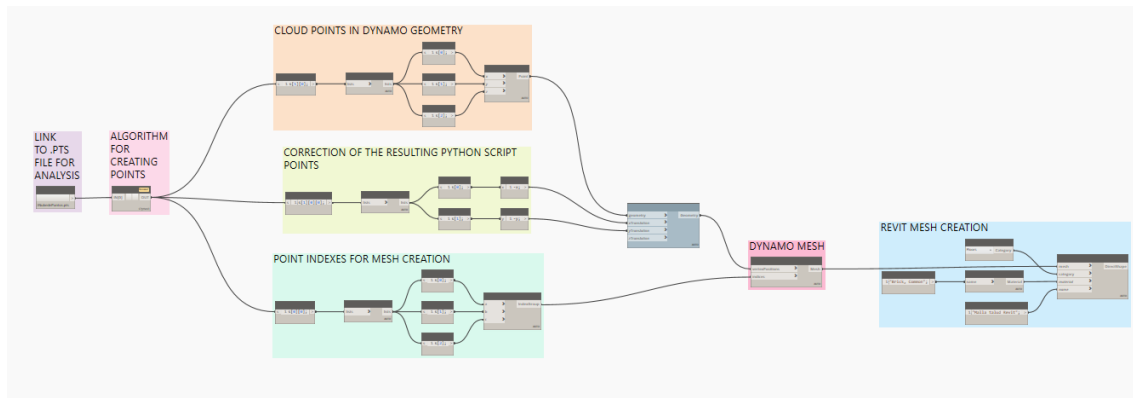

Figure 4. 49 Overview of the mesh creation programme

#### 4.6 Visualising the early warning system

The interpretation of the information provided by the sensors should be visualised on the markers designed in Dynamo, which is viewed in Revit. The aim of this project is to provide real time updated information from the sensors in a clear and easy to interpret manner, visually.

The design of the marker is based on providing, in Revit, the last position of the sensor in its three coordinate axes. In addition, limits will be established, which, linked to a colour scale, will facilitate the interpretation of the data. In this way, when the sensor exceeds the established limit on any of the coordinate axes, it will be displayed in red meaning extreme levels of movement. On the contrary, when the sensor remains static, the marker will remain green. In the case of a movement of intermediate magnitude, i.e. not exceeding the set limits, but still relevant, it is orange.

The design of the marker can be changed as desired. For this project a simple rectangular marker has been chosen with the reading of the three points X, Y, and Z, but the resulting marker can be modified as a Group in Revit.

In the study carried out for this project, it was only designed based on a single sensor, but the programming carried out could be used in the same way in the case of a network of sensors. It would only be necessary to duplicate, as many times as necessary for each type of sensor, the code and connect it to the database.

#### 4.6.1 Programming scheme

The design of the scoreboard has been carried out as follows;

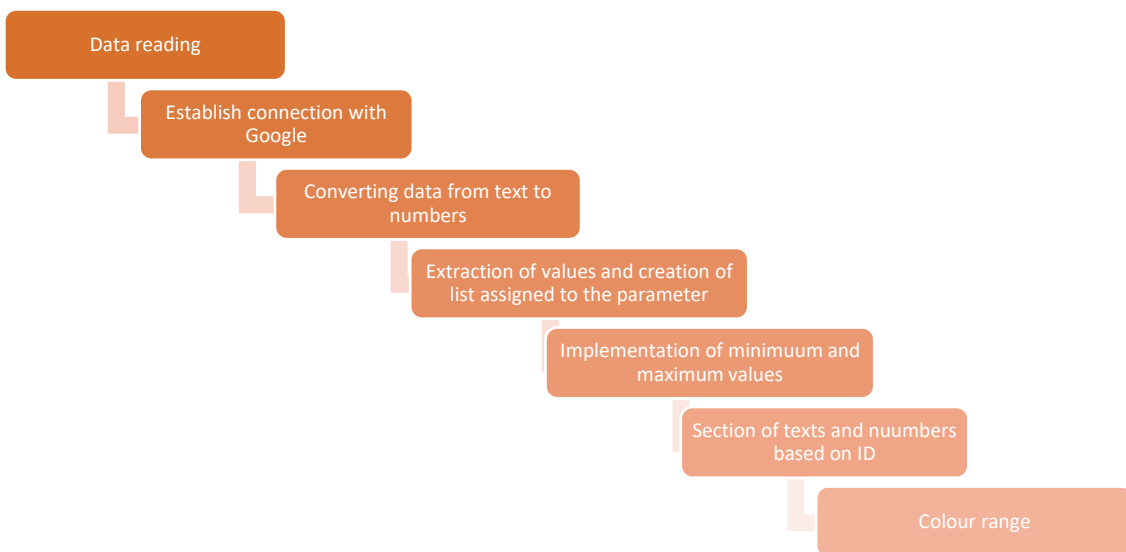

Figure 4. 50 Programming scheme for the design of the Early Warning System marker

Firstly, the source of information that will feed the marker of the early warning system must be established. To do this, the URL belonging to the Google Sheet spreadsheet used in the development of the sensors is entered.

In order to establish communication with Google Sheet via the URL, a specific programming code is required. Therefore, it is necessary to use a ".json" credentials file for authentication to Google to be able to work with the Google Sheet data. This is achieved through Python Script.

It is at this point that the connection to the Google server must be established via the ".json" credentials file.

```

1 |
2 | import sys
3 | import clr
4 | clr.AddReference('ProtoGeometry')
5 |
6 |
7 | from Autodesk.DesignScript.Geometry import *
8 | sys.path.append(r"C:\Users\Robe\AppData\Local\Programs\Python\Python38\Lib
  | \site-packages")
9 |
10 | import gspread
11 | from oauth2client.service_account import ServiceAccountCredentials
12 |
13 | client_secrets.json
14 | scope = ['https://www.googleapis.com/auth/drive']
15 | credentials = ServiceAccountCredentials.from_json_keyfile_name(r'C:\Users
  | \Robe\OneDrive\Documents\Rob\College\UCC\Dynamo\ENTREGA
  | \client_secrets.json', scope)
16 |
17 | url = IN[0]
18 |
19 | gc = gspread.authorize(credentials)
20 |
21 | sps = gc.open_by_url(url)
22 |
23 | worksheet = sps.get_worksheet(0)
24 |
25 | numerofilas = len(worksheet.col_values(1))
26 |
27 | values_list = worksheet.row_values(numerofilas)
28 |
29 | values_list = values_list[1:-1]
30 |
31 | OUT = values_list

```

Figure 4. 51 Python script for communication with the database

Once the connection to the server has been established, the output text strings are converted into numbers (Figure 4.43).

In order to make the new list of number data easier to read, it was decided to round the numerical data to two decimal places (Figure 4.44).

The values are then extracted from the table and a string list is generated to assign the parameters (Figure 4.45).

This is then used to change the value of the text displayed in the marker, i.e. the information displayed for the last position of the sensor. Once the name of the parameter to which it corresponds has been assigned, the base and the texts are selected via the IDs. The selection of the base through the ID's is done in the same way to get the numbers provided by the marker (Figure 4.46).

The next point is to assign the limits where the marker will change colour according to the set values. As mentioned before, for this study it was set to replace values that were greater than 3 and less than -3. In this way, the marker will show colour changes when values are exceeded positively or negatively (Figure 4.47).

These limit values can be changed and values from slope stability studies can be established. For this study, a limit of 3 centimetres was established since, in the simulations carried out with the sensor on the slope, movement greater than this value resulted in the sensor sliding down the slope.

To conclude the development of the early warning system, the colour range with which the sensor data will be visualised in Revit is implemented. Similarly, the colours used in this study were those used in the traffic light system as they are easy to interpret. Finally, the node "Element.OverrideColorView" which will implement the solid fill with the colours is assigned to the pattern indicated in the active view (Figure 4.48).

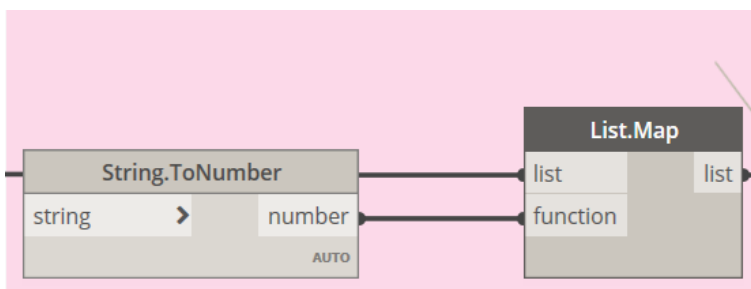

Figure 4. 52 Text to number conversion

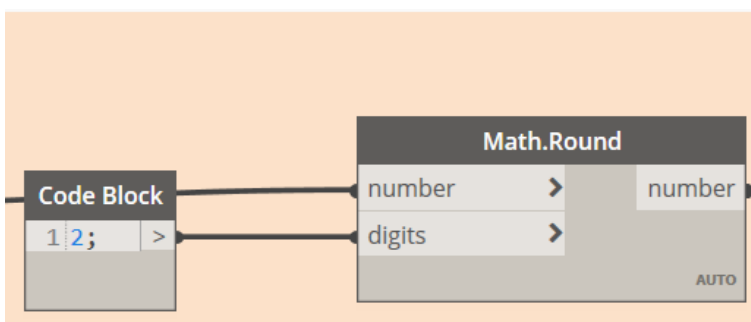

Figure 4. 53 Rounding numbers to two decimal places



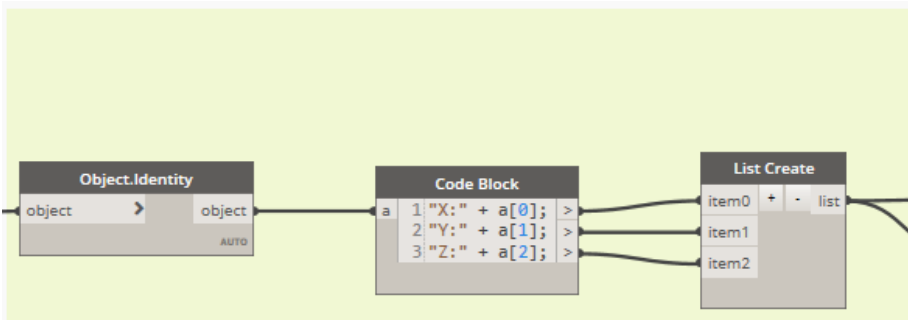

Figure 4.54 Assignment of parameters

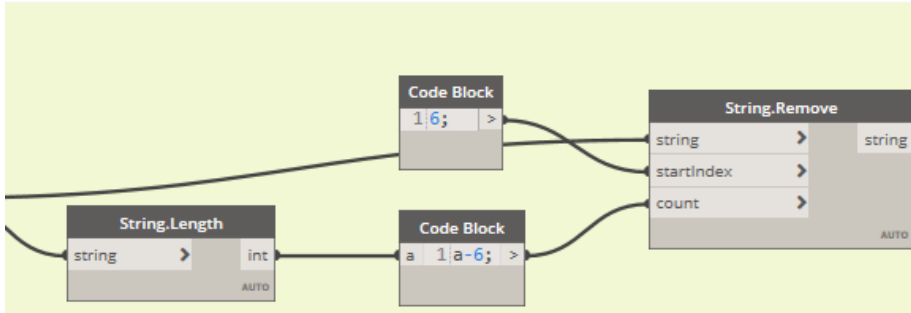

Figure 4.55 Assignment of parameters II

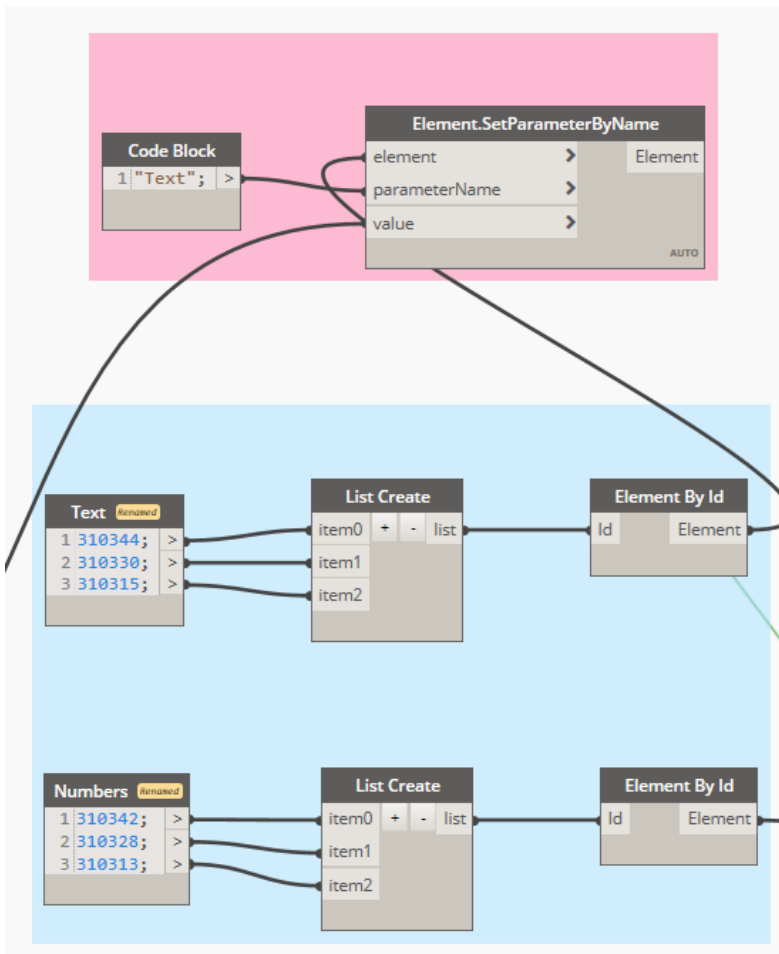

Figure 4.56 ID selection for text and marker

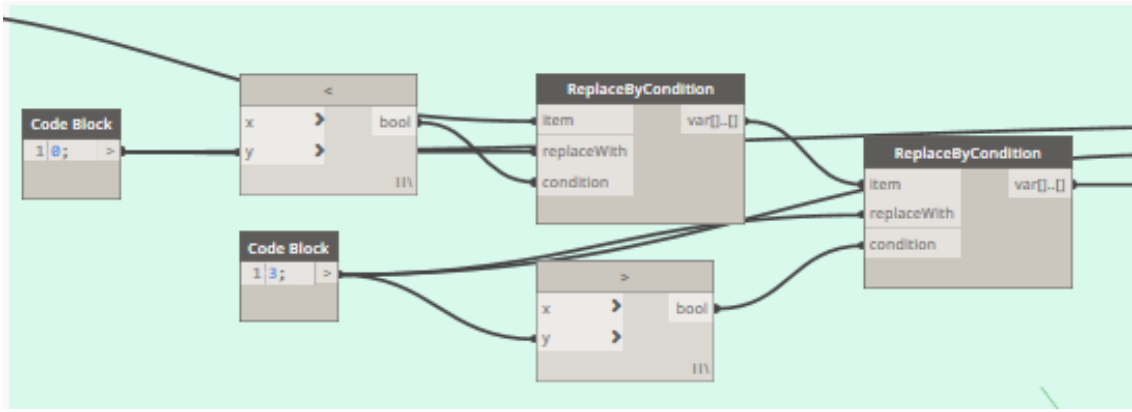

Figure 4. 57 Setting range limits for the alert level

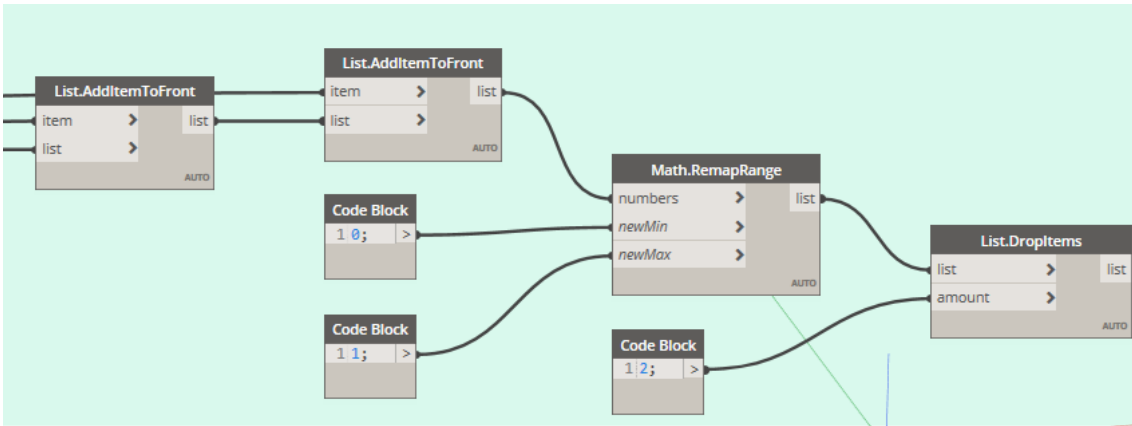

Figure 4. 58 Setting range limits for the alert level II

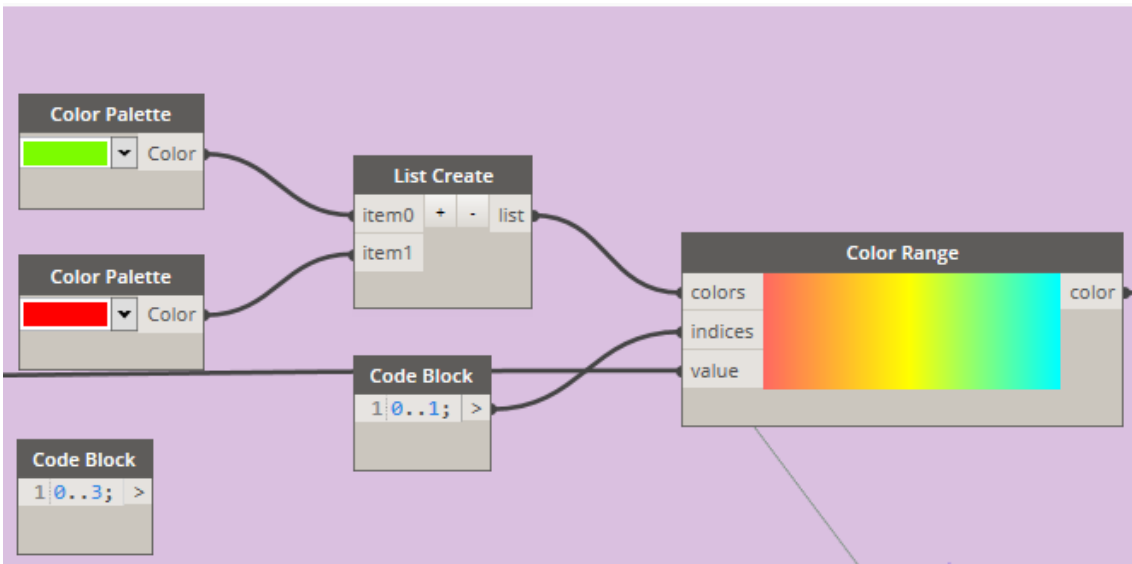

Figure 4. 59 Set colour scale for results display

#### 4.6.2 Data visualisation

Once all programming is finished, the data visualisation in Revit is undertaken following the next steps.

1. Upon completion of the mesh, it is visible in Revit, and it is in Revit where all operations that are considered appropriate on the visualisation of the mesh will be carried out. Therefore, the Dynamo programming, unless adjustments to the programming code are required, does not need to be opened again to be executed in Revit. Hence, the visualisation process is accelerated as both Dynamo and Revit do not need to constantly update the mesh, thus optimising the operating system's efficiency.
2. The marker created in the early warning system will be visible in a new Revit project. In order to display the marker on the mesh, the previously generated mesh has to be opened in the project with the marker. Using the "copy" and "paste" commands, the marker can be moved onto the mesh. The location of the EWS marker is done manually, making it easy to change the location depending on the sensor location at the time of the survey.
3. The programming of the marker is open in the background. Dynamo periodically reads the code every 15 seconds, verifying if there are any changes in the data. Each time the sensor sends new data, it will be reflected in the Google Sheet, which acts as a source of information in the code, ensuring that the marker is constantly updated.

In this way, it is possible to have the risk rating with real-time updated information from the sensors located on the slope.

##### *4.6.2.1 Expansion of SHM BIM system to entire Study site*

For this study, the visualisation of the marker designed in the EWS was only located on the Connolly St. slope. However, it is possible to apply the EWS marker to other base files, be it retaining walls, slopes, or any other monitored structure.

In the case of several monitored structures in the same area, a 3D image of the entire location could be generated to see the status of the different markers in a single image. This is possible in multiple ways. Through the use of Dynamo software with an open access programming language, a plug in allows for the incorporation of parameters of a

map along with the topography of the area to generate a 3D map with accurate building and structural elevations. This model can then be used for the accurate placement of the marker of the early warning system for each monitored structure.

Another way to achieve an extrusion of the areas buildings to get an overview of the locality is through the ELK package, developed by Timothy Logan (102), developed to integrate all OSM format data and topography to quickly generate a 3D extrusion map.

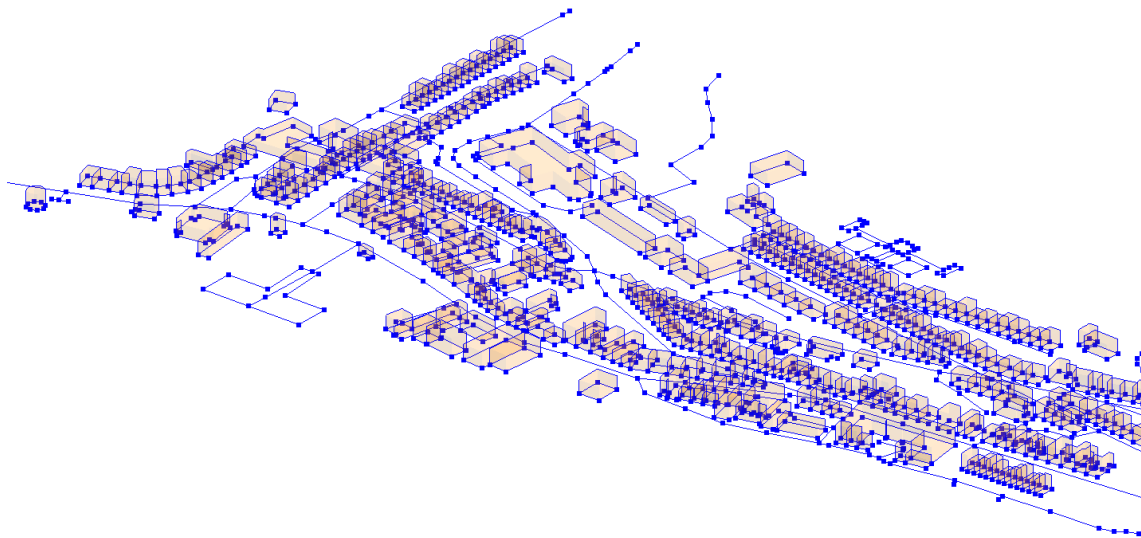

Figure 4. 60 Cobh 3D Visualisation in Revit

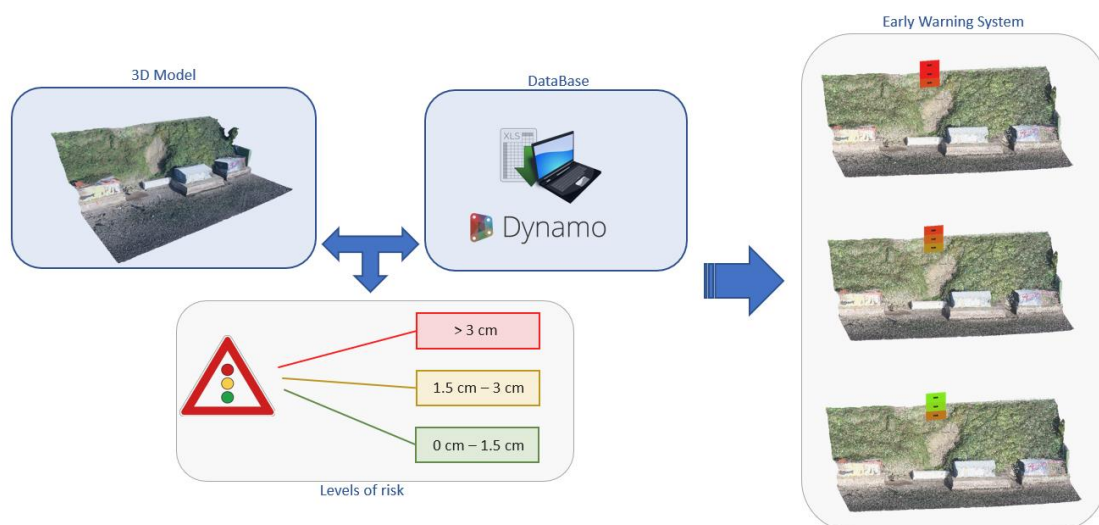

Figure 4. 61 BIM Early Warning System Design Overview

## 5. Results

Different methodologies employed in the study provided a wide range of results. By collecting data via laser and drone, point clouds were obtained, which provided the study with knowledge of the structural state of each of the elements under study, as well as a clear definition of their geometry. In addition, the point clouds were subsequently used as the basis for the creation of a mesh, which would represent the possible movements of the sensors.

Therefore, the results of the sensors provided a numerical insight into the real behaviour of the Connolly Street slope. According to the results, different levels of studies were proposed that would help to understand and clarify the possible responses of the sensors to different situations.

The integration of all the data in BIM helped to generate a single model with all the information obtained. Moreover, the results obtained from the topography and the sensors were the basis for the creation of an early warning system, which indicated the responses of the sensor located on the slope to different levels that were simulated.

### 5.1 Topographic survey results

The structures under review were first analysed using the laser scanner. This provided a detailed point cloud of each structure which could be incorporated with the sensor data to develop an early warning system. As the Connolly Street slope was the structure at greatest risk of collapse, this was further analysed using the drone. A point cloud was then processed from the images taken by the drone. By comparing the two-point clouds, it was the drone point cloud that provided the highest quality results and were compatible for processing into BIM and therefore enabling the development of an early warning system.

#### 5.1.1 Laser scanner

The result of the field work carried out with the Leica MS60 laser was a point cloud of each of the structures analysed.

The number of points of each element examined in this project depended on the surface scanned. Therefore, the level of detail in the creation of the mesh based on the obtained point cloud depended on the number of points and dimensions of the surface.

A mesh was generated for each of the 5 structures scanned in this study. The creation of the mesh aided in the visualisation of the elements, as well as to carry out analysis and measurements on the structures. For this, different modes of analysis using the Cyclone 3DR software were used, in order to compare the differences in the results obtained. The different modes for generating meshes in Cyclone 3DR were adjusted according to the characteristics of each project.

Table 5 summarises the characteristics of each structure scanned using the laser scanner. A comparison is made of the differences between the point cloud and the mesh created from each structure. Each point cloud and mesh are displayed below.

*Table 5 Summary of the point cloud and mesh characteristics*

Characteristics of the point cloud	Characteristics of the mesh
<b>LAUNDRY HILL</b>	
Number of points: 495,389	Average distance between points: 0.041
Maximum length: 18.05 metres	Triangulation size: 0.13
	Total area: 74.56 m <sup>2</sup>
<b>HILLVIEW TERRACE</b>	
Number of points: 1,250,904	Mean distance between points: 0.05
Maximum length: 32.03 metres	Angle between facets: 10 degrees
	Total area: 117,124 m <sup>2</sup>
<b>CHURCH STREET</b>	
Number of points: 822,242	Number of points analysed: 792,922
Maximum length: 22.98 metres	Number of triangles: 1,529,565
	Total area: 136,059 m <sup>2</sup>
<b>CATHEDRAL BUTTRESSES</b>	
Number of points: 5,307,084	Number of points: 2,547,654
Maximum length: 72.02 metres	Numbers of triangles: 5,051,891
	Maximum length: 72.02 metres
<b>CONNOLLY STREET SLOPE</b>	
Number of points: 7,374,899	Average distance between points: 0.025
Maximum length: 284 metres	Triangulation size: 0.08

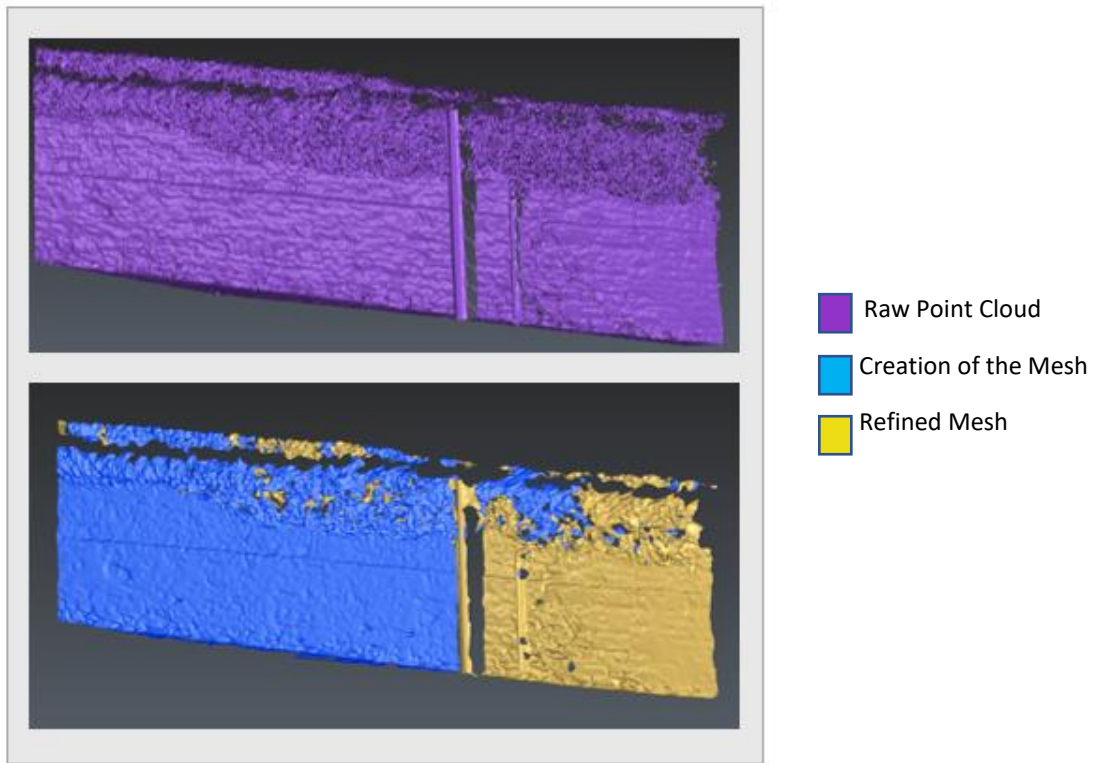

Figure 5. 1 Laundry Hill; Point Cloud and Mesh

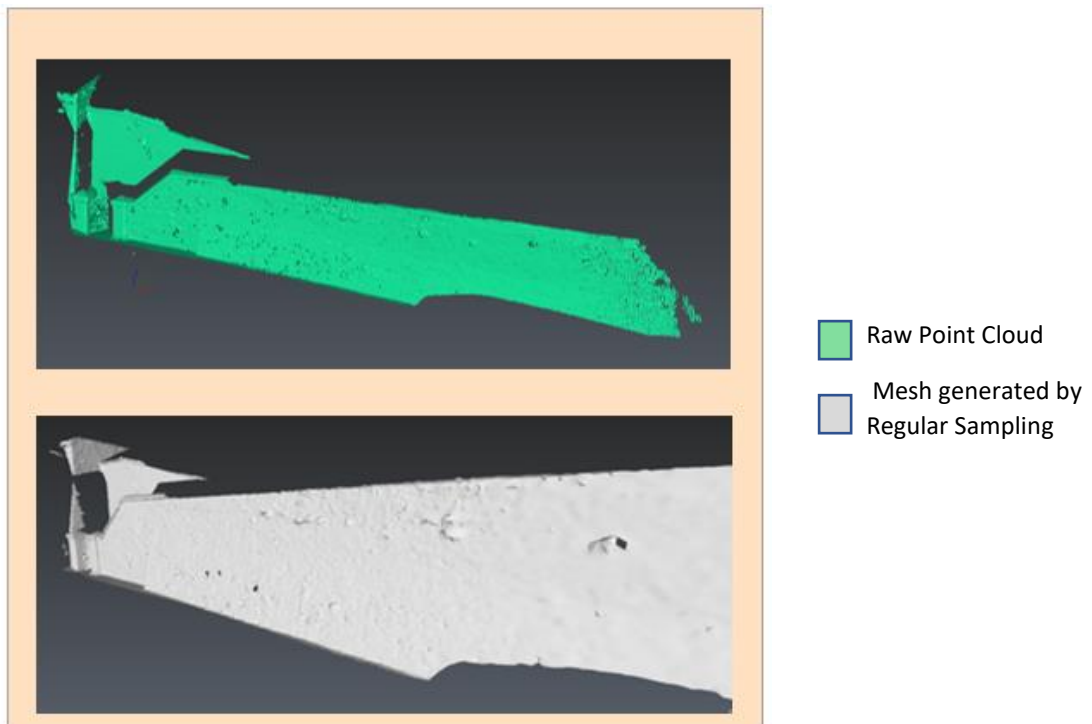

Figure 5. 2 Hillview Terrace; Point Cloud and Mesh

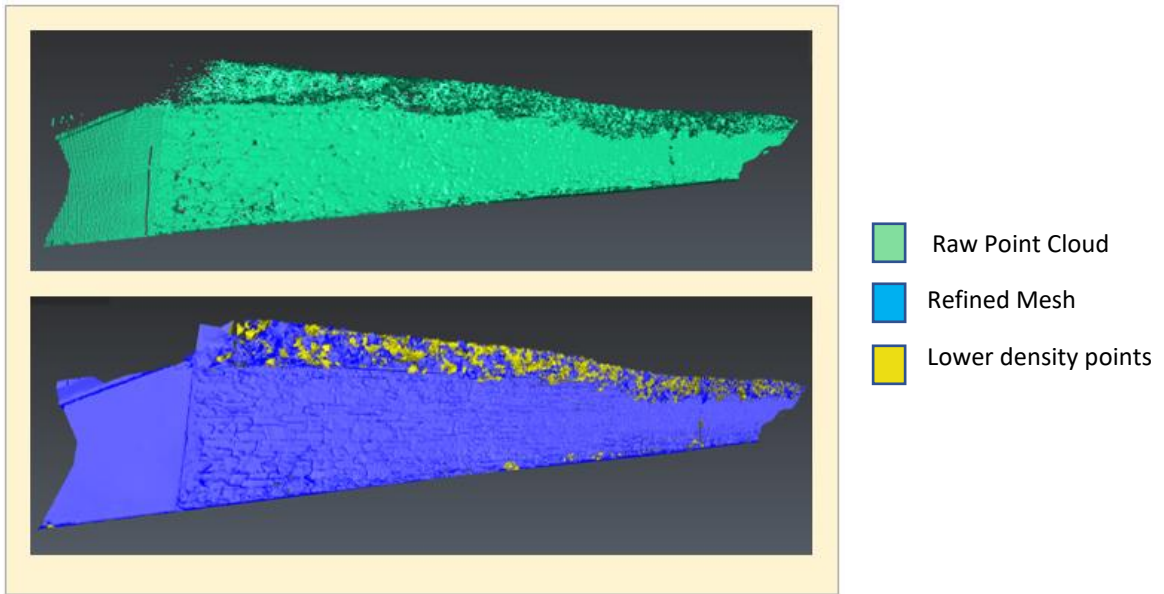

Figure 5. 3 Church Street; Point Cloud and Mesh

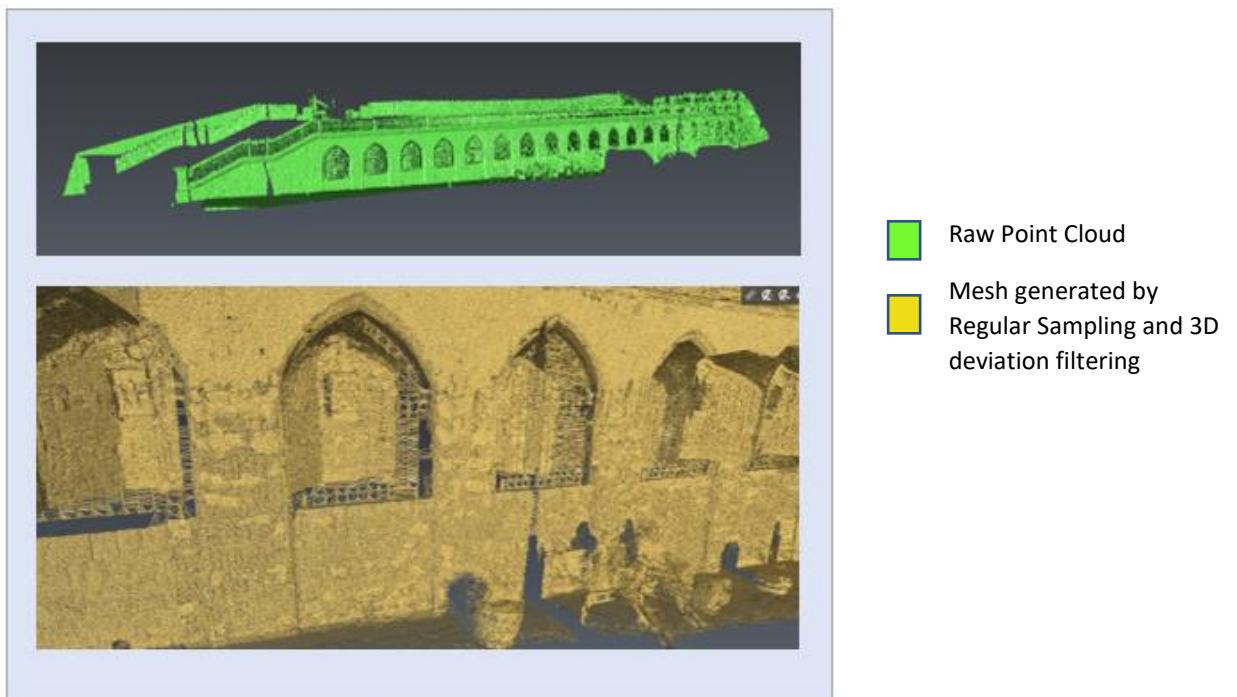

Figure 5. 4 Cathedral Buttresses; Point Cloud and Mesh



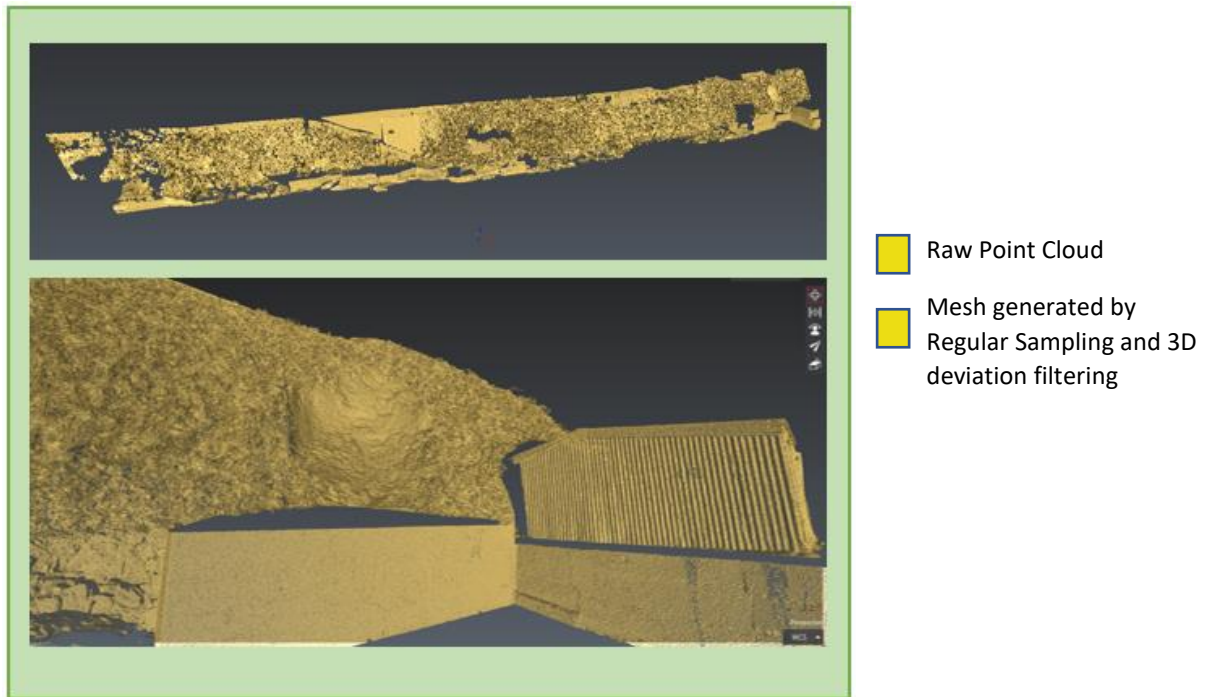

Figure 5. 5 Connolly Street slope; Point Cloud and Mesh

#### 5.1.1.1 Laundry Hill

The high number of points on a relatively small surface provided an excellent, high quality result. The distance between the points making up the point cloud is very small, resulting in a very compact point cloud, giving the impression that it looks like a mesh.

The creation of the mesh for this element was carried out using the Cyclone 3DR process "meshing in two steps", which allowed for the generation of an estimated mesh with regular triangles. "Meshing in two steps" allows for first, the creation of a mesh and secondly refining of the created mesh.

Noise reduction for this type of mesh creation would be more effective the larger the distance between the points. In addition, the mesh can be refined with deviation error criteria. For this study, an error deviation of 0.005 metre and an inter-facet angle of 10° were produced by Cyclone following the generation of the mesh.

#### 5.1.1.2 Hillview Terrace

During the scanning process of this retaining wall, there was a parked vehicle which was removed from the image in order to be able to perform the analysis more effectively.

A mesh was generated on the "Regular sampling" type element, which shows the point cloud with the least noisy points.

#### *5.1.1.3 Church Street*

There was a large amount of vegetation on the upper face of the wall. There was also a loss of verticality along its length, as well as several fractures on its main face.

The mesh was generated using the "3D deviation filtering" option. In this way, it was possible to obtain a mesh where all points have the same weight in relation to the noise. In this way, the calculation can be carried out much faster through "mathematically exact" points.

The quality of the result in this case is superior due to the noise reduction and the working mode of the chosen option, working only with exact points.

#### *5.1.1.4 Cathedral Buttresses*

For the creation of the mesh in this type of detailed structures, the combination of "Regular sampling" and "3D deviation filtering" was used to provide the most detailed result.

This type of mesh requires more time to execute, depending on the volume of points of the element to be analysed. For this project, only a small part of the total structure was analysed in order to verify the level of detail of the mesh against this volume of points.

The level of detail, the resolution and the working capacity of the software make it possible to carry out inspections and analysis on specific elements in this type of heritage structures. The level of range of the laser facilitates the inspection, as in the vast majority of cases it is almost inaccessible in some parts of large structures or extremely costly to carry out.

#### *5.1.1.5 Connolly Street*

The image shows the total volume of the point cloud, which makes up the entire slope. This is the union of the two-point clouds that were made separately. The software allowed the two-point clouds to be perfectly georeferenced.

To avoid performance losses in the creation of the grid, the analysis was carried out separately, showing the most relevant part of the study in the draft.

The creation of the mesh was carried out using the "Regular sampling + 3D deviation filtering" method, given the high level of detail it provided.

### 5.1.2 Drone

A total of three drone flights were carried out for the inspection of the Connolly Street slope. Each of the flights were done using different flight parameters such as different speeds, heights and surface dimensions. These varying parameters were used to establish which flight generated the highest quality images. The results of the three flights were an average of 20 aerial photographs of the slope. The images obtained from the different flights were analysed and it was decided to choose the flight that gave the highest quality images. In this case, the flight mission chosen was the second shoot. These images were considered to be the best results as they provided the clearest images as well as including adequate surrounding area and the brightness of these images allowed a detailed point cloud to be created.

#### Photographs resulting from the flight



Figure 5. 6 Photographs resulting from the flight over the soil slope on Connolly Street

The result of the flight chosen for data processing was a total of 22 photographs. The image processing through the Pix4DMapper software provided a 3D point cloud which was derived from the overlapping photographs, resulting in the reconstruction of the slope in original colours.

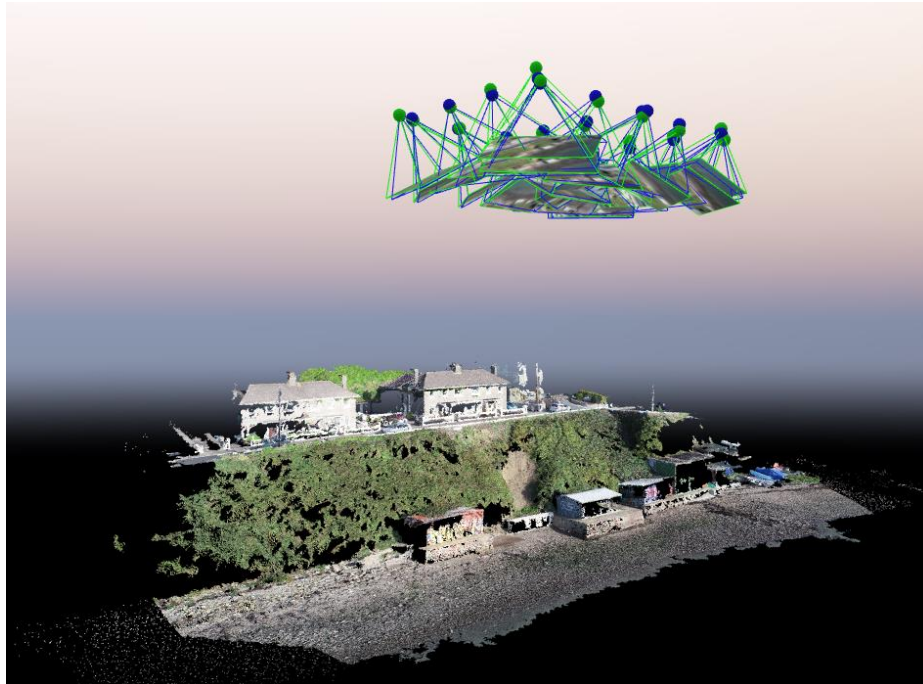

*Figure 5. 7 Point cloud resulting from drone flight over Connolly St slope, Cobh*

For the reconstruction of the slope as shown, the software performed a reading of the number of 2D points in each of the photographs taken.

From the single drone flight, the resulting point cloud has various levels of detail at various points. The drone flight centred on the soil slope itself and did not focus on the area surrounding the slope and so the resulting point cloud has black holes surrounding the slope. The single drone flight was considered sufficient as the level of detail from the soil slope images were adequate for the generation of the point cloud. When the point cloud was further processed by Revit, the apparent black holes were eliminated.

Table 6 3D Points from 2D key point Matches

<b>In 2 images</b>	123230
<b>In 3 images</b>	32094
<b>In 4 images</b>	13651
<b>In 5 images</b>	7149
<b>In 6 images</b>	4247
<b>In 7 images</b>	2489
<b>In 8 images</b>	1662
<b>In 9 images</b>	1038
<b>In 10 images</b>	752
<b>In 11 images</b>	467
<b>In 12 images</b>	381
<b>In 13 images</b>	293
<b>In 14 images</b>	198
<b>In 15 images</b>	145
<b>In 16 images</b>	93
<b>In 17 images</b>	90
<b>In 18 images</b>	59
<b>In 19 images</b>	35
<b>In 20 images</b>	48
<b>In 21 images</b>	31
<b>In 22 images</b>	2

The resulting point cloud was used as the basis for the placement of the early warning system.

Since the software interoperability for the colour point cloud was limited to four formats, namely, las, .laz, .ply, .xyz. it was decided to process the images in the Recap Pro software, which allowed the export of the file in .PTS and thus could be incorporated into Revit through the option to insert point cloud.

The result obtained is a mesh generated by the created point cloud. The software allows various operations and measurements to be carried out. However, the great advantage of processing information through this software is its interoperability.

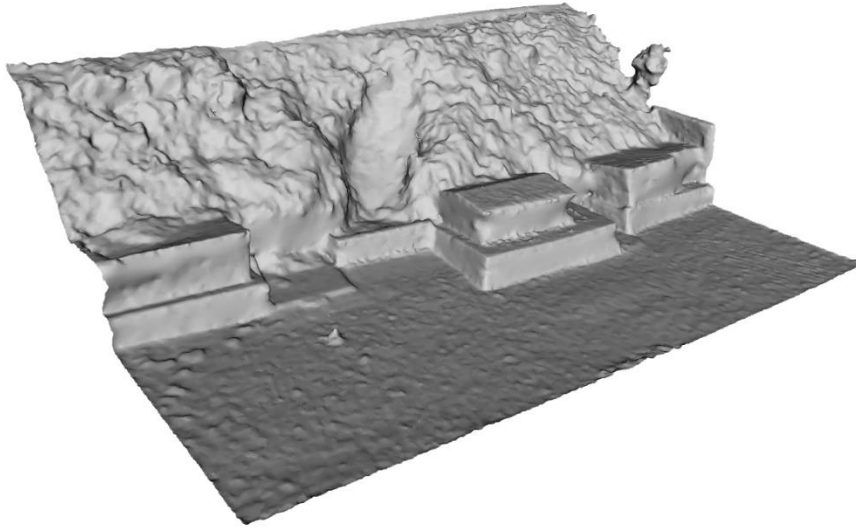

*Figure 5. 8 Connolly Street slope mesh*

The generated mesh is composed of 93,232 vertices and 163,727 faces. This forms a high level of detail extracted from the photographs. The surveyed surface is 1,932 m<sup>2</sup> and a volume of 15,505,125 m<sup>3</sup>.

Once the laser and drone point clouds were obtained, the results between the two were compared to choose which one would be used as the basis for the early warning system image in BIM.

Thus, the point cloud provided by the laser scanner was a high data density point cloud. This type of result is excellent when the project requires a large volume of data to be processed for analysis, due to the accuracy it provides. Nevertheless, in this study, it was necessary that the point cloud to be used was more detailed in terms of the 3D recreation of the Connolly Street slope. Due to the operation of the laser, gaps are created in the point cloud when the laser beam cannot take readings at the angles at which it is working.

Therefore, the point cloud provided by the drone met the requirements of this study.



Figure 5. 9 Connolly Street slope coloured mesh

The drone performs aerial photogrammetry from multiple angles, which provided a point cloud that represented the study area in greater detail.

### 5.1.3 Sensors

The information provided by the sensor was contained in the spreadsheet created in Google Sheet. The design structure of the spreadsheet is based on 5 columns, where the time at which the last data reading from the sensor was obtained is reflected, the next three columns belong to the X, Y and Z coordinates, the last column corresponds to the calibration status of the sensor.

	A	B	C	D	E	F	G	H	I	J	K
1	Time	X	Y	Z	C						
2											
3											
4											
5											
6											
7											
8											
9											
10											
11											
12											
13											

Figure 5. 10 Googlesheet spreadsheet

A new reading of the sensor movements was obtained every 15 minutes. The time between sending data and the delivery of the data to the spreadsheet varied between 10 and 15 seconds, depending on the studies carried out on the Connolly Street slope. These times were found to vary depending on the coverage status of the modem. In general, the signal coverage level was more than acceptable throughout the study area.

The data collected from the sensor during the different test days was classified into three different levels according to the results obtained. Different methods were used to obtain different derivations in order to be able to reach all the possible scenarios that could occur on the slope.

#### 5.1.3.1 Case studies

After the results obtained during the course of this research on the sensor on Connolly St slope, it was found that the movement data displayed by the sensor were values close to zero. This meant that, during the period of monitoring that it was taking movement data, the sensor remained in a state that was considered to be practically static.

Consequently, the SHM system robustness was tested by simulating three different classifications of possible sensor movements, where these simulations were carried out to emulate hypothetical cases. By carrying out these hypothetical case studies, the reliability and accuracy of the sensor in extreme or adverse conditions can be established. It also showcases how versatile the structural health monitoring system is.

##### 5.1.3.1.1 Level 0

Level 0 corresponded to the behaviour of the slope during the test days. It revealed movement data with small variations, which could reflect vibrations from traffic, weather conditions such as wind or rough sea conditions and high tide, which could affect the measurement sensitivity of the sensor on the slope.

The following table shows the data reflected by the sensor in the Google Sheet spreadsheet for a short period of time, as the data collected during the days of measurement were considered not significant.





	A	B	C	D	E	F	G	H	I	J	K
1	Time	X	Y	Z	C						
2	11:34:03	0.17343	0.03874	0.17354	3						
3	11:49:14	1.38685	1.37430	0.27356	3						
4	12:05:11	2.53975	1.97643	1.38756	3						
5	12:20:32	1.86887	1.37330	1.36378	3						
6	12:36:01	3.98630	3.26157	3.87563	3						
7	12:51:27	3.18634	3.14230	0.32773	3						
8	13:06:45	2.39863	2.37673	2.47864	3						
9	13:21:08	0.98367	0.65430	0.23723	3						
10	13:36:42	0.29862	0.16342	1.38753	3						
11	13:52:42	4.87662	2.76748	3.32786	3						
12	14:07:56	3.98643	3.06476	4.05623	3						

Figure 5. 12 Sensor data, Level 1

The data sample shown here reflects data from one of the simulations carried out over an interval of almost 3 hours of fieldwork, with the responses obtained were reflected in the data sheet in 15-minute intervals.

#### 5.1.3.1.3 Level 2

The data contained in this level exceed the mean of 3 centimetres in one of the three coordinates; x, y or z. Therefore, a simulation had to be performed where the magnitude of the movements in the sensor was greater than the previous level of 3cm. For this purpose, and in order to obtain relevant data for the study, the sensor was placed in an unattached state on the slope surface to facilitate the simulation of a sensor slip. The sensor was positioned in the same way as in the previous level, and once stabilised, movements were provoked in the sensor by disturbing the soil supporting the sensor box with a probe until it slid along the surface.

	A	B	C	D	E	F	G	H	I	J	K
1	Time	X	Y	Z	C						
2	14:57:34	0.08276	0.82637	0.28732	3						
3	15:13:21	2.48734	1.98643	1.36378	3						
4	15:28:43	3.23647	2.87234	0.36487	3						
5	15:44:12	2.39837	3.37243	0.29396	3						
6	15:59:54	5.76743	2.38474	1.39864	3						
7	16:17:01	4.27867	1.87365	0.23964	3						
8	16:32:13	5.32640	1.38943	0.23984	3						
9	16:47:22	8.37634	3.23643	2.36340	3						
10	17:03:56	1.36430	-2.23764	-1.37863	3						

Figure 5. 13 Sensor data; Level 2

The test had to be repeated several times, as the desired sliding of the sensor could not be carried out cleanly. The slope surface had a lot of vegetation, which prevented continuous sliding. Even so, the simulation could be carried out, as the aim of the

simulation was to exceed the limits set in the early warning system to see how the movements would be visualised in the 3D object-oriented model. In addition, it was checked that even in the event of a landslide, and with rapid and sudden movements, the connection between the sensor and the receiver remained at all times regardless of the degree of movement.

## 5.2 Integrated BIM based SHM Tool

The integration of results in BIM was carried out in the same way as the sensor results were obtained, i.e. the information source for the programming code was the Google Sheet data sheets obtained for each level of study. In this way, it was possible to verify the response of the marker to different values at different study levels.

The marker designed always showed a colour scale that varied from green, which was assigned to the smallest value in the sample, to red, which corresponds to the highest value in the data sample. For this project, it was decided to leave the numerical value of the sample on the marker in order to be able to see how big the movement of the marker was.



*Figure 5. 14 Point Cloud of Connolly St. slope in Revit*

The above image shows the visualisation of the slope in Revit. The location of the marker was integrated manually on the image of the slope, since the sensor was not georeferenced. In the case of several sensors on the same slope, the programming designed for this project allows the relocation of the marker as appropriate, as well as

the dimensions of the same typography and text to be displayed. The model shown here was chosen to work on this project.

### 5.2.1 Level 0

This level of study revealed data with values between 0.001 and 1.5 cm. The visualisation of the sensor data is shown below.

	A	B	C	D	E
1	Time	X	Y	Z	C
2	09:25:32	0.01200	0.03865	0.97373	3
3	09:41:12	0.00200	0.08654	0.18363	3
4	09:56:45	0.00230	0.07463	0.25638	3
5	10:11:43	0.01400	0.00076	0.16563	3
6	10:22:04	0.12300	0.13735	0.49264	3
7	10:37:23	0.03100	0.03973	0.50683	3
8	10:52:32	0.04100	0.08353	0.08364	3
9	11:07:48	0.10900	0.28540	0.39654	3
10	11:22:54	0.00090	0.00737	0.93647	3
11	11:38:04	0.02400	0.19656	0.76340	3
12	11:53:23	0.18760	0.12284	1.86673	3
13	12:08:02	0.03465	0.08420	1.53400	3
14	12:23:23	0.06354	0.07552	0.77300	3
15	12:39:41	0.13865	0.17463	1.73400	3
16	12:54:58	0.02455	0.27474	1.69000	3
17	13:09:11	0.24646	0.07630	0.75330	3
18	13:24:27	0.37393	0.07363	1.47843	3
19	13:40:46	0.03742	0.01662	0.96630	3
20	13:55:14	0.26323	0.06420	1.66493	3
21	14:11:35	0.06484	0.01477	2.64640	3
22	14:26:02	0.03520	0.07638	0.77330	3
23	14:41:36	0.15630	0.29575	1.97357	3
24	14:57:03	0.25749	0.19936	1.67634	3
25	15:12:28	0.07686	0.03640	0.28368	3
26	15:27:53	0.37596	0.17330	2.93674	3
27	15:43:09	0.18476	0.20364	1.96764	3
28	15:59:03	0.25744	0.30443	1.53384	3
29	16:16:24	0.00474	0.18365	0.97673	3

Figure 5. 15 Goolesheet spreadsheet; Level 0

The values chosen for the time 12:54:58 represent values between 0.02 and 1.69 centimetres. This sample has been chosen as it exemplifies how the marker design will read the readings by differentiating them by colour, between two different scales of green for values less than 1.5cm, and brown for value greater than 1.5cm.

This data sample did not compromise slope stability.

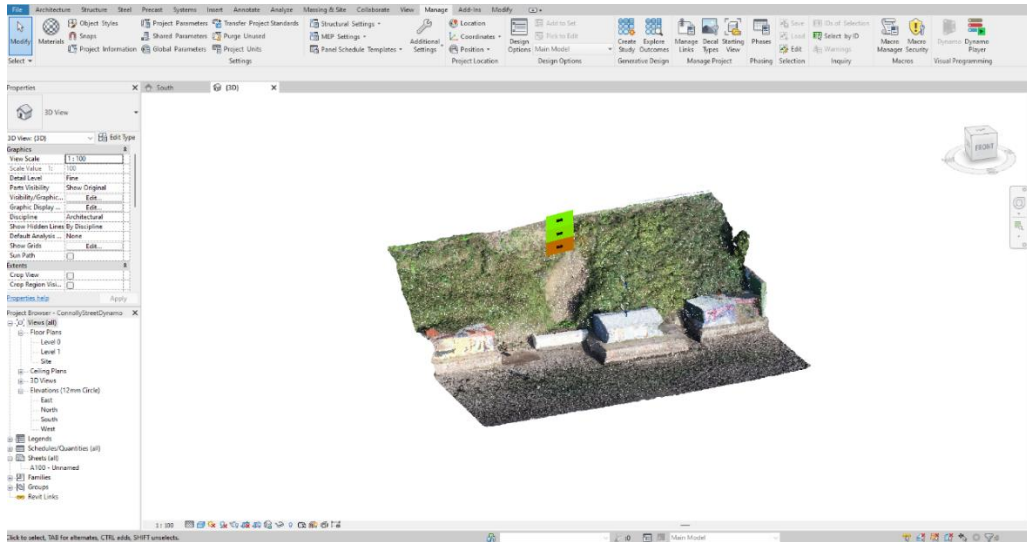

Figure 5. 16 Marker visualisation for Level 0 in Revit



Figure 5. 17 Marker for Level 0

The data showed one value above Level 0 on the Z-coordinate axis. The other two values, x and y-coordinates remained within the range of 0.001 and 1.5 cm.

### 5.2.2 Level 1

Level 1 data consisted of changes in the x, y or z coordinates greater than 1.5cm but less than 3cm. For this purpose, a sample of data from the sequence obtained from Level 1 collected by the sensor in the simulation was chosen. Similarly, a time was chosen that best exemplified the values sought.

	A	B	C	D	E
1	Time	X	Y	Z	C
2	11:34:03	0.17343	0.03874	0.17354	3
3	11:49:14	1.38685	1.37430	0.27356	3
4	12:05:11	2.53975	1.97643	1.38756	3
5	12:20:32	1.86887	1.37330	1.36378	3
6	12:36:01	3.98630	3.26157	3.87563	3
7	12:51:27	3.18634	3.14230	0.32773	3
8	13:06:45	2.39863	2.37673	2.47864	3
9	13:21:08	0.98367	0.65430	0.23723	3
10	13:36:42	0.29862	0.16342	1.38753	3
11	13:52:42	4.87662	2.76748	3.32786	3
12	14:07:56	3.98643	3.06476	4.05623	3

Figure 5. 18 Googlesheet spreadsheet; Level 1

The values chosen for the time 12:05:11, ranged from 1.38 in the Z-coordinate to a maximum value of 2.53 in the X-coordinate.

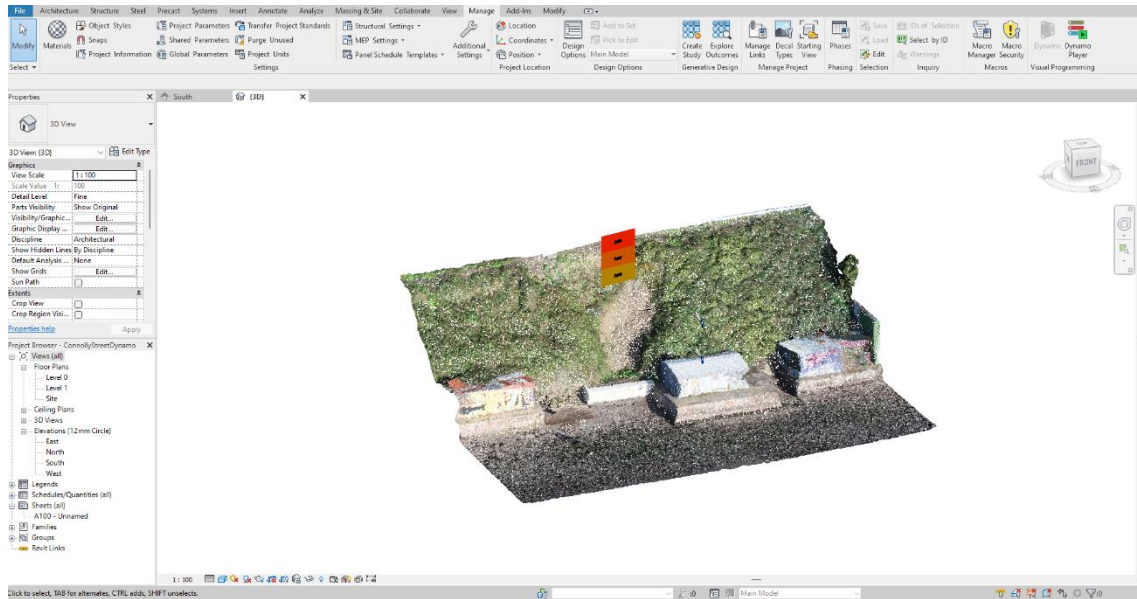

Figure 5. 19 Marker visualization for Level 1

For these values, the marker flagged the X-coordinate value as a potential hazard result, since it is the closest value to the set limit of 3.



Figure 5. 20 Marker for Level 1

### 5.2.3 Level 2

This level represented the highest level in the early warning system indicating significant amounts of slope movement. It worked with values above the maximum limit, set at 3cm. The data table with which this study was carried out was for a period of 2 hours,

	A	B	C	D	E
1	Time	X	Y	Z	C
2	14:57:34	0.08276	0.82637	0.28732	3
3	15:13:21	2.48734	1.98643	1.36378	3
4	15:28:43	3.23647	2.87234	0.36487	3
5	15:44:12	2.39837	3.37243	0.29396	3
6	15:59:54	5.76743	2.38474	1.39864	3
7	16:17:01	4.27867	1.87365	0.23964	3
8	16:32:13	5.32640	1.38943	0.23984	3
9	16:47:22	8.37634	3.23643	2.36340	3

Figure 5. 21 Googlesheet spreadsheet; Level 1

where slips could be collected from the sensor. The most unfavourable values were chosen for the display of the early warning system marker.

At one point in the study, the sensor experienced a small slip that was picked up by the sensor on the X-coordinate axis with a value of 8.37 centimetres.

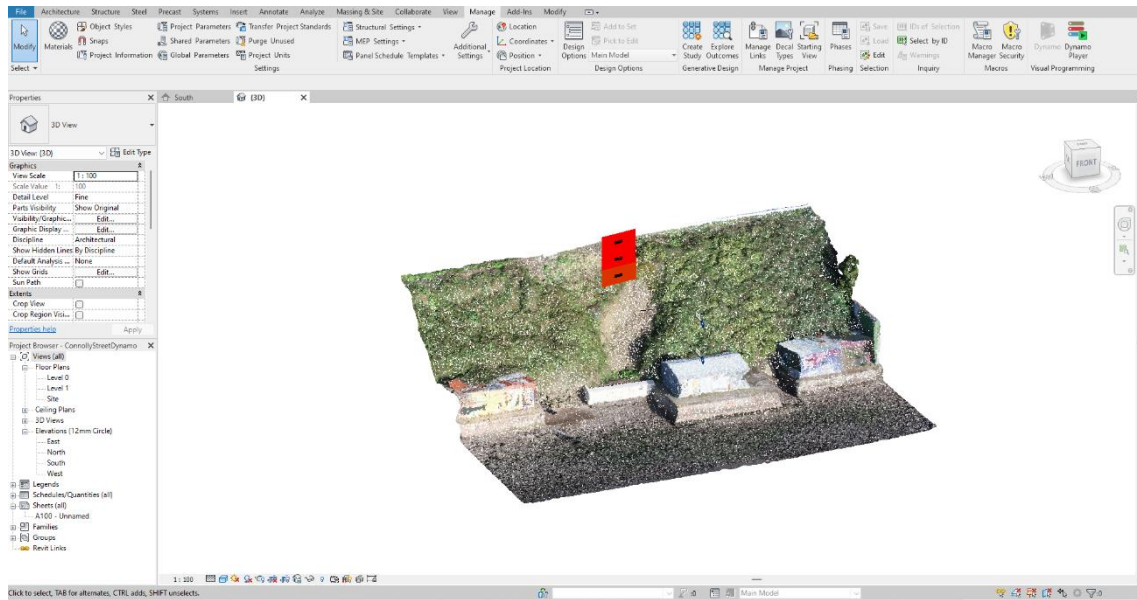

Figure 5. 22 Marker visualization for Level 2

The simulation carried out in this study was intended to simulate a small-scale landslide event. The displacement that occurred was sufficient to raise the early warning system to the maximum level. The marker indicated the values of the three coordinates in red, expressing that the movement produced at the sensor was unusual and that some slope slippage could have occurred.

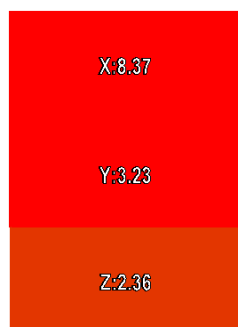

Figure 5. 23 Marker for Level 2

Using this system, the exact risk for landslide or slope collapse cannot be determined due to the contribution of a number of factors, such as vegetation, weather, vibrations. This system, however, does alert the user to the degree of movement on the surface which would be an indication of the level of change. Through this interpretation, the user would be able to deduce the slopes or retaining walls that are deteriorating quickest, being more likely to collapse and require the earliest intervention.

### 5.3 Economic analysis of BIM SHM system

On successful development of the BIM SHM system, the total cost of obtaining the constituents, manufacturing the sensors, and developing the early warning system were analysed as a means of comparing the financial impact of applying the BIM SHM system instead of traditional surveying methods.

As previously mentioned, traditional means of slope and retaining wall surveillance requires approximately 60 hours, four times a year for interval information on structural stability and safety. These current methods come at a cost of approximately €40,000 per annum.

Like traditional methods, the topographical surveying requires the largest financial investment. Using the Leica laser scanner, the cost of developing the BIM SHM system rises significantly. Should the Leica laser scanner be used solely for the development of the point cloud, this would be associated with a rental cost of €1800 per week. This process would only be required on initiating the surveillance process or on the event of significant changes to the structure, planned or otherwise. Conversely, if the drone was used for the surveillance of retaining walls and structures, this would come at a cost of approximately €6000 to purchase the drone with the surveillance camera. Although a higher expense than the laser scanner, the cost of the drone is a once off cost that can be used for long periods of time. The added benefit of the drone is that the amount of time required to analyse the structures is much shorter than the laser scanner with higher quality images and point clouds available. Furthermore, the drone can access structures that are otherwise difficult to reach.



Following the successful completion of topographical surveillance, the sensor must be deployed. The total cost of constructing and programming is approximately €150 per sensor. The development of a mesh would require four to five sensors per structure, depending on the level of detail required. Per annum, for the development of a mesh on all 24 structures at risk in Cobh, the sensors would cost €15,000.

It is clear to see that there is a significant cost reduction using the BIM SHM. Both in financial cost of developing the SHM but also time savings. This novel system potentially has the added benefit of identifying areas requiring intervention at an earlier time and therefore could reduce the cost of repairing structural damages.

*Table 7 Capital cost of establishing SHM*

	Traditional SHM	BIM SHM	
<b>Topographical surveillance:</b>	€14,400	Leica laser scanner	Drone
		€3600	€6000 (purchase)
<b>Sensor:</b>	N/A	€15,000	€15,000
<b>Labour:</b>	€24,000	€6000	€3000
<b>Total capital cost:</b>	€38,400	€24,600	€24,000

*Table 8 Ten-year cost projection of SHM*

	Traditional SHM	BIM SHM
<b>Annual cost</b>	€38,400	€3,000
<b>10-year cost</b>	€384,000	€51,000

## 6. Discussion

### 6.1 Limitations

On concluding this research, a number of limitations can be seen. Firstly, this study centres on the use of a single sensor incorporating an accelerometer and gyroscope. Although this sensor was sufficient in the development of an early warning system for at-risk structures, there are more accurate sensors available. The MPU6050 sensor uses a three-axis technique of slope surveillance, delivering data through x, y and z axes. This sensor was used due its affordable cost, adequate results as well as the ease of code development. Due to the three axis results, the data had to undergo double integration to calculate sensor movement increasing the margin of error and negatively impacting on the results. Sensors such as the Arduino 9 axis motion sensor are superior to the MPU6050 whereby they measure movement through orientation, acceleration and magnetic fields. This therefore mitigates the need for double integration providing more accurate results with a smaller margin of error. This sensor was not applied in this research due to the complexity of coding required to program the sensor for the application of slope surveillance.

Furthermore, this research centres on data received from a single sensor incorporated to a point cloud. This was sufficient for the development of an early warning system of slope damage showing slope changes through a colour coordinated marker, but the single sensor was unable to showcase the actual slope surface changes. Through the use of a network of sensors, forming a mesh, any slope surface changes would instead be visualised showing the relationship of movement of each sensor to the other. In other words, a 3D visualisation of sensor movement could be seen.

An advantage of using the point-cloud is that the results are available at quick speed with little difficulty in software processing. Should a mesh instead be applied, the duration would be extended with further difficulty in software processing and more storage required. The graphic card required for point clouds is more accessible and used more commonly. The application of a mesh for this type of surveillance would require more advanced graphic cards therefore requiring better core computing software.

## 7. Conclusions

### 7.1 Conclusion Summary.

The fundamental goal of the research was to find a way to monitor geological structures at high risk of collapse and to integrate the results into a BIM SHM system.

The main conclusion from the study presented in the subsections below are:

1. Both UAV and Laser scanner can provide high-resolution low-cost data for building a BIM SHM System, however UAVs are more suitable for Geohazard monitoring
2. Non-intrusive low-cost wireless sensors can be used to monitor a range of at-risk structures, but each system requires site specific calibration and setup.
3. A BIM base SHM system is capable of monitoring geohazards in real-time and can provide an early warning system for at-risk structures.
4. This SHM system utilises industry standard BIM software and provides high resolution datasets that can be used to improve mitigation and remediation strategies. The script developed for the purpose of developing an SHM system on Dynamo is opensource, therefore further work could be carried out to translate this opensource data to the .IFC format in order to enable it to be used across platforms in BIM. Furthermore, Arduino sensors are low cost and opensource coding is easily applied to their use further promoting the application of this SHM system to other platforms. Google sheet is a free platform that is suitable for small projects however this could be upgraded to a database type model such as the Azure database for multi-model systems.
5. Over a 10-year period it was shown that the proposed SHM system would provide a lower cost (€51,000) solution to monitoring Geohazards and retaining structures compared with current practices.

### 7.2 Topographic surveillance conclusions

Firstly, the structures under study had to be examined by means of analytical models, and to this end, it was decided to explore the use of novel tools that would expand on and enhance the current monitoring techniques. Tools such as scanners and drones were applied and their results combined to form accurate analytical models.

The results obtained from the inspections carried out with the laser scanner were analytical models that could be processed using the Cyclone 3DR software. These analytical models were made up of point clouds which, depending on the surface analysed and the laser scanner configuration chosen for the inspection, provided the cloud with a greater or lesser number of points. The greater the number of points, the greater the density obtained and, therefore, the higher the quality of the results. However, when an inspection was chosen with the maximum number of points possible, the duration of the inspection was prolonged to a duration that was unnecessary for the level of detail achieved and the resulting point cloud.

The use of a drone was applied for the surveillance of a high-risk soil slope as a comparison to the laser scanner. This device is growing in popularity for photographic and surveillance purposes and its application in the geometric data capture for this research proved to be of great benefit. Having access to angles otherwise difficult to achieve. The drone was able to take a series of images that could then be processed through the Pix4DPro software to form a detailed point cloud. When the point clouds between the laser scanner and drone were compared, the additional angles obtained by the drone resulted in a higher quality point cloud. Through the use of the drone, the time required for adequate image capture and point cloud development was shortened significantly therefore promoting drone use further.

Furthermore, the laser scanner has certain limitations depending on the type of structures to be inspected. In this research, five inspections were carried out on different types of structures, namely retaining walls, slopes and buttresses. From these inspections, it can be seen that structures of greater heights can be surveyed with the laser scanner however the results lose precision and also lack well rounded perspectives. Another limitation is the lighting: if the structure is in a shaded area or, conversely, the lighting too bright, the level of detail may be negatively impacted. This shortcoming is rectified in this study through the use of a drone. Drones provide high quality aerial photographs from varying angles and heights. Moreover, drones offer access to areas of interest that would otherwise be out of range and inaccessible to laser scanners, broadening the scope of surveying. Together with the laser scanner, drones perfectly

supplement the task of inspection and tracking, providing a high-density high-quality point cloud.

This study shows that the combination of two surveying tools, drones and laser scanners, offers a powerful method of inspecting structures in a high-quality manner. This research demonstrates how the two tools supplement each other and provide valuable information for structural health. This technique of surveying is novel to geotechnical engineering and of importance at present due to the ongoing environmental damage to coasts and geostructures secondary to climate change. The need for the use of such technologies is now considered important to ensure adequate structural health. The contribution of quality and accuracy in the results, reduction of personnel costs and inspection times, in addition to anticipating intervention in time, are powerful advantages provided by these tools.

### 7.3 Monitoring

In order to create an efficient early warning system, it must be based on effective monitoring. Therefore, in this study, an accelerometer and gyroscope sensor were designed and coded to monitor an at-risk slope located on Connolly Street, Cobh. The sensor was positioned on the surface of the slope and provided 15-minute intervals of real-time sensor movements with the sensitivity of the sensor providing millimetre scale positions. Due to this level of accuracy, the changes seen on a geostructures could be classified into three categories to easily stratify the significance of change adding to the relevance of such methods.

Through the development of the sensor, assembling it and designing the specific programming code, it was possible to confirm that monitoring could be carried out with low-cost, simple-to-operate sensors. Through the application of the developed sensors on the Connolly Street slope, real-time surveillance of the slope could be carried out. This data was readily available and showed that the level of movement seen on the Connolly Street slope was not significant with sensors data showing minimal slope movement. Furthermore, any minor movements seen were affected by factors such as weather and vibrations from nearby transport infrastructure.

To expand further on the suitability of the sensor for real-time slope monitoring, a number of simulations were carried out to replicate potential slope movements. The data recorded from these simulations showed significant sensor movements, whilst also highlighting the accuracy of data recording and sensor durability in severe events. The real-time sensor data could then be incorporated, through the 3D object-oriented model to develop an accurate and sensitive early warning system.

A limitation of the sensor was seen in the processing of the gross data to the actual value of displacement. To obtain the displacements of the sensor, the acceleration had to be integrated in time, thus giving the velocity, and the integral of the velocity would cause the displacement. This type of integral operations in the programming code could give rise to measurement errors. Through observing the data over time, it was found that the small measurement errors had a direct correlation with time, i.e. the longer the sensor was operating, the more the measurement error value increased. However, it was possible to make measurements on the slope with the accelerometer and gyroscope sensor as, for this research, the sensor application time was not prolonged over months. Therefore, for future monitoring studies, it would be recommended to refine the formulation in the programming code of the sensor to be able to disregard the increase in measurement error with respect to time.

#### 7.4 BIM as an SHM platform

Through the development of the sensors and the point cloud, an early warning system was then developed using the Revit software in combination with visual programming software. This software enabled the construction of a coded 3D object-oriented model to show the changes of sensor position and therefore slope movement in real-time.

Revit was chosen as the main software for the development of the early warning system as it provides greater versatility and interoperability with easy integration of data from various software in different formats. In doing so, the software can process and produce point clouds or meshes that can be incorporated with different sensors for early warning systems of different designs. Although Revit is the primary software used for the visualisation of the early warning system, Dynamo is also required in this process. Dynamo, coded specifically for this research, was used to update the early warning system and therefore the degree of risk associated with sensor movement and slope

changes. Through the data produced by the sensor, Dynamo analysed and configures the warning marker based on the pre-set intervals of risk stratification. The marker is colour coordinated with increased risk resulting in a clear and accurate representation on the Revit model.

Furthermore, one of the key advantages of using BIM in the early warning system is the easy interpretation of results. Throughout the design process of the early warning system in this study, the idea of creating a tool that is easy to understand and easy to work with was key. Through the use of a traffic light colour-coded system the changes that the slope is undergoing as well as the risk of catastrophic events such as landslides could be easily understood. Based on the slope used in this study, the interval by which Dynamo displays the different categories of colour on the display marker was pre-set, based on the findings. This, however can be edited and changed to suit the structure being surveyed, the number of sensors used as well as the level of detail required in the early warning system. Therefore, showcasing further the versatility of this system.

The steps used in this project are core to the development of an early warning system of different structures undergoing surveillance. Through the combination of the above detailed software, this system provides versatility and adaptability that can be translated and enhanced for future monitoring projects. The number of sensors used determines the level of detail associated with the early warning system but also provides the opportunity to have results that mirror the slope surface relationship with sensors that provide life like representation of slope movements on the Revit model.

The cost associated with the development of this early warning system was much reduced when compared to the current surveillance methods. The greatest cost associated with the development was obtaining the materials for sensor development. This in itself was small with the components readily available and various options as desired. Although tools such as the laser scanner and drone are expensive, their cost is once off where their application is extensive and without further running costs. The principles used in the programming of the MPU6050 sensor are translatable to other sensors and therefore reduce the timing required in the development stages. The code provides variability in desired results as well as offering a means to use different sensors on the surveillance of structures. Furthermore, through this system, the need for in-

person surveillance is mitigated through the use of drones whilst the continuous data associated with the early warning system eliminates the need for recurrent in-person monitoring whilst providing up-to-date results remotely. Moreover, this method allows for early intervention and preventative measures at the optimal time.

### 7.5 Application

An increased demand and need for early warning systems has become apparent, not only for the monitoring of slopes but also retaining walls. With worsening climate, aging and consumer damage, structures of importance are at risk of damage and destruction-economically, structurally and potential putting lives at risk. Through the use of early warning systems, as seen in this research, there is means for continuous monitoring and surveillance of such structures allowing for early intervention and therefore prevention of potentially catastrophic events. Through the application of modern technology such as drones, in combination with BIM software, this research showcases a prime example of how geotechnical engineering is advancing whilst making an important contribution to the world around us. Coastal towns such as Cobh, Cork built on steep topographical ground are at risk of continuous structural damage. Although there have been preventative measures applied, with the construction reinforced shotcrete walls and rockfall netting, these types of preventative measure are not sustainable going forward without adequate surveillance first. A more cost effective and sensitive means of surveillance is required and so, this research showcases a means of surveying the integrity of at-risk structures for the application of preventative measures at the optimal time at low cost.

### 7.6 Recommendations for future works

For further enhanced early warning system development, increasing the number of sensors used as well as the type of sensors would lead to more accurate results, displayed in a more visual manner and therefore easier to understand. This thesis focuses on the use of a single sensor on a soil slope. Should this number be increased depending on the slope size and number of sensors available. By linking and georeferencing the sensors, the resulting early warning system could mirror the slope surface and therefore provide more accurate warnings of surface changes. By georeferencing the sensors, this allows for the relationship of slope movement to be



understood and therefore leads to optimal preventative measures in structures undergoing ongoing deterioration.

Regarding data collection, the drone was flown at a single height to capture the required images to make the point cloud. This single flight gathered a total of 22 images which were then translated into a point cloud using Pix4D. The resulting point cloud contained a number of black holes as a result of interference from vegetation, the angle of light and shadows on the slope surface. To better survey the slope using a drone, three separate drone flights should be carried out at different angles. This would provide more images with the resulting point cloud being more detailed and containing fewer black holes. This would enhance the results and optimise the early warning system.

In summary, BIM SHM provides the means to accurately, affordably and easily monitor at risk structures in real-time. It is a novel way that is of key importance in preventing any further deterioration or landslides in Ireland.

## Appendix 1

### Technical characteristics of Arduino Uno WiFi Rev2

#### Technical characteristics

- Microcontroller: ATMEGA4809
- Operating voltage: 5V
- Supply voltage (recommended): 7 - 12V
- Digital I/O pins: 14
- PWM digital I/O pins: 5
- Analog pins: 6
- DC current per I/O pin: 20 mA
- DC current per 3.3V pin: 50 mA
- Clock speed 16 MHz
- LED\_BUILTIN: 25
- Dimensions:
- Length: 68.6 mm
- Width: 53.4 mm
- Weight: 25 g
- Flash memory: 48 KB (ATMEGA4809)
- SRAM: 6,144 Bytes (ATMEGA4809)
- EEPROM: 256 Bytes (ATMEGA4809)

## References

1. Gariano SL, Guzzetti F. Landslides in a changing climate. *Earth-Science Reviews*. 2016;162:227-52.
2. Winter MG, Shearer B, Palmer D, Peeling D, Harmer C, Sharpe J. The Economic Impact of Landslides and Floods on the Road Network. *Procedia Engineering*. 2016;143:1425-34.
3. Creighton R, Doyle A, Farrell E, Fealy R, Gavin K, Henry T, et al. Landslides in Ireland. Geological Survey of Ireland. Department of Communications, Marine and Natural Resources; 2006.
4. Jaedicke C, Van Den Eeckhaut M, Nadim F, Hervás J, Kalsnes B, Vangelsten BV, et al. Identification of landslide hazard and risk 'hotspots' in Europe. *Bulletin of Engineering Geology and the Environment*. 2014;73(2):325-39.
5. Partners MWA. Cobh Landslides Project Cork 2012 [Available from: <https://www.mwp.ie/project/cobh-landslides/>].
6. O'Shea M. Cobh Landslides Prevention Programme. Retaining Wall Monitoring Programme. Survey Report No. 2. 2016.
7. Yadav DK, Jayanthu S, Das SK, Chinara S, Mishra P. Critical review on slope monitoring systems with a vision of unifying WSN and IoT. *IET Wireless Sensor Systems*. 2019;9(4):167-80.
8. Koopialipour M, Murlidhar BR, Hedayat A, Armaghani DJ, Gordan B, Mohamad ET. The use of new intelligent techniques in designing retaining walls. *Engineering with Computers*. 2020;36(1):283-94.
9. Schuster RL, Highland LM. Socioeconomic and environmental impacts of landslides in the Western Hemisphere. Report. 2001. Report No.: 2001-276.
10. Díaz JS. Deslizamientos y estabilidad de taludes en zonas tropicales: Instituto de Investigaciones sobre Erosión y Deslizamientos, Ingeniería de ...; 1998.
11. Keefer David K, Wilson Raymond C, Mark Robert K, Brabb Earl E, Brown William M, Ellen Stephen D, et al. Real-Time Landslide Warning During Heavy Rainfall. *Science*. 1987;238(4829):921-5.
12. Biasutti M, Seager R, Kirschbaum DB. Landslides in West Coast metropolitan areas: The role of extreme weather events. *Weather and Climate Extremes*. 2016;14:67-79.
13. Guthrie RH, Mitchell SJ, Lanquaye-Opoku N, Evans SG. Extreme weather and landslide initiation in coastal British Columbia. *Quarterly Journal of Engineering Geology and Hydrogeology*. 2010;43(4):417.
14. McSweeney E. The science of bogslides: We must learn how to judge the risks. *The Irish Times*. 2021;Sect. Science.
15. Hickey D. Landslide risk puts in danger zone. *Irish Examiner*. 2008.
16. Zhao Y, Tong Z-Y, Lü Q. Slope Stability Analysis Using Slice-Wise Factor of Safety. *Mathematical Problems in Engineering*. 2014;2014:712145.
17. Cawood FT, Stacey TR. Survey and geotechnical slope monitoring considerations. *Journal of the Southern African Institute of Mining and Metallurgy*. 2006;106(7):495-501.
18. Hughes PN, Hen-Jones R, Stirling RA, Glendinning S, Gunn DA, Chambers JE, et al. Challenges in monitoring and managing engineered slopes in a changing climate. *E3S Web Conf*. 2016;9.
19. Zaki A, Chai HK, Razak HA, Shiotani T. Monitoring and evaluating the stability of soil slopes: A review on various available methods and feasibility of acoustic emission technique. *Comptes Rendus Geoscience*. 2014;346(9):223-32.
20. Falcetelli F, Yue N, Di Sante R, Zarouchas D. Probability of detection, localization, and sizing: The evolution of reliability metrics in Structural Health Monitoring. *Structural Health Monitoring*. 2021:14759217211060780.

21. Tsilimantou E, Delegou ET, Nikitakos IA, Ioannidis C, Moropoulou A. GIS and BIM as Integrated Digital Environments for Modeling and Monitoring of Historic Buildings. *Applied Sciences*. 2020;10(3).
22. Autodesk. BIM Benefits [Available from: <https://www.autodesk.com/industry/aec/bim/benefits-of-bim>].
23. Cobh cliff faces to be stabilised. *The Irish Times*. 2011;Sect. Ireland.
24. Cobh Landslides Project Cork 2009 [Available from: <https://www.mwpeng.co.uk/portfolio-items/cobh-landslides-project-cork/>].
25. Cork County Council [Available from: <http://corkcocoplans.ie/>].
26. Brownjohn JMW. Structural health monitoring of civil infrastructure. *Philosophical Transactions of the Royal Society A: Mathematical, Physical and Engineering Sciences*. 2007;365(1851):589-622.
27. Samboni F, Bedoya S, Caicedo Rendon O, Vivas F. MEC IoT Monitorización de estructuras civiles en el contexto IoT2018.
28. Farrar CR, Worden K. An introduction to structural health monitoring. *Philosophical Transactions of the Royal Society A: Mathematical, Physical and Engineering Sciences*. 2007;365(1851):303-15.
29. Nguyen B-Q-V, Lee S-R, Kim Y-T. Spatial probability assessment of landslide considering increases in pore-water pressure during rainfall and earthquakes: Case studies at Atsuma and Mt. Umyeon. *Catena (Giessen)*. 2020;187:104317.
30. Koizumi K, Oda K, Komatsu M, Ito S, Tsutsumi H. Slope structural health monitoring method against rainfall-induced shallow landslide. *IOP Conference Series: Materials Science and Engineering*. 2019;615(1):012046.
31. Song G, Wang C, Wang B. Structural Health Monitoring (SHM) of Civil Structures. *Applied Sciences*. 2017;7(8).
32. Sumitro S, Wang ML. Sustainable structural health monitoring system. *Structural Control and Health Monitoring*. 2005;12(3-4):445-67.
33. Huang Yang H. Slope Stability Analysis by the Limit Equilibrium Method: Fundamentals and Methods2014. 0 p.
34. Medina-Zaldívar Y, Cartaya-Pires M. Uso del software Slide para el análisis del comportamiento sísmico de taludes. *Ciencia & Futuro*. 2018;8(2):1-17.
35. Moss RM, Matthews SL. In-service structural monitoring. a state of the art review. *Structural Engineer*. 1995;73(2).
36. Parra AFQ, Mejía RV. ESTADO DEL ARTE EN MONITORIZACIÓN DE SALUD ESTRUCTURAL: UN ENFOQUE BASADO EN AGENTES INTELIGENTES/STRUCTURAL HEALTH MONITORING: AN INTELLIGENT AGENT APPROACH: SCIENCE AND ENGINEERING NEOGRANADINA. *Ciencia e Ingeniería Neogranadina*. 2010;20(1):117-32.
37. Pines D, Aktan AE. Status of structural health monitoring of long-span bridges in the United States. *Progress in Structural Engineering and Materials*. 2002;4(4):372-80.
38. Dubin EE, Yanev BS, editors. *Managing the East River bridges in New York City*2001: SPIE.
39. Oliveira S, Alegre A. Seismic and structural health monitoring of Cabril dam. Software development for informed management. *Journal of Civil Structural Health Monitoring*. 2020;10(5):913-25.
40. Chen WH, Lu ZR, Lin W, Chen SH, Ni YQ, Xia Y, et al. Theoretical and experimental modal analysis of the Guangzhou New TV Tower. *Engineering Structures*. 2011;33(12):3628-46.
41. Ni YQ, Xia Y, Liao WY, Ko JM. Technology innovation in developing the structural health monitoring system for Guangzhou New TV Tower. *Structural Control and Health Monitoring*. 2009;16(1):73-98.
42. Aytulun E, Soyöz S. Implementation and application of a SHM system for tall buildings in Turkey. *Bulletin of Earthquake Engineering*. 2021.
43. Rainieri C, Dey A, Fabbrocino G, Santucci de Magistris F. Monitoring and modeling of a flexible retaining wall2010.

44. Sevilla M. Introducción Histórica a la Geodesia. *Pensamiento matemático*. 2012;2:1-63.
45. Vazquez-Ontiveros J, Vazquez Becerra G, Gaxiola-Camacho JR. Implementación de la técnica PPP-GNSS para el monitoreo de la salud estructural en puentes 2019.
46. Kuzina E, Rimshin V, editors. Deformation Monitoring of Road Transport Structures and Facilities Using Engineering and Geodetic Techniques. *International Scientific Conference Energy Management of Municipal Transportation Facilities and Transport EMMFT 2017; 2018 2018//*; Cham: Springer International Publishing.
47. Sadarviana V, Abidin HZ, Santoso D, Kahar J, T AR. Influence of groundwater level to slope displacement by geodetic method. *AIP Conference Proceedings*. 2016;1730(1):060003.
48. Thakur M, Kumar T, Narayanan M. Monitoring Landslides from Satellites. 2020.
49. Colesanti C, Wasowski J. Investigating landslides with space-borne Synthetic Aperture Radar (SAR) interferometry. *Engineering Geology*. 2006;88:173-99.
50. Baltsavias EP. Airborne laser scanning: basic relations and formulas. *ISPRS Journal of Photogrammetry and Remote Sensing*. 1999;54(2):199-214.
51. Abellán A, Oppikofer T, Jaboyedoff M, Rosser NJ, Lim M, Lato MJ. Terrestrial laser scanning of rock slope instabilities. *Earth Surface Processes and Landforms*. 2014;39(1):80-97.
52. Ding X, Ren D, Montgomery B, Swindells C. Automatic Monitoring of Slope Deformations Using Geotechnical Instruments. *Journal of Surveying Engineering*. 2000;126(2):57-68.
53. Oliva González A. Instrumentación y control de taludes y laderas 2015.
54. Stark TD, Choi H. Slope inclinometers for landslides. *Landslides*. 2008;5(3):339.
55. Ha DW, Park HS, Choi SW, Kim Y. A Wireless MEMS-Based Inclinometer Sensor Node for Structural Health Monitoring. *Sensors*. 2013;13(12).
56. Hermans T, Nguyen F, Robert T, Revil A. Geophysical Methods for Monitoring Temperature Changes in Shallow Low Enthalpy Geothermal Systems. *Energies*. 2014;7(8).
57. Saneiyani S, Ntarlagiannis D, Werkema DD, Ustra A. Geophysical methods for monitoring soil stabilization processes. *Journal of Applied Geophysics*. 2018;148:234-44.
58. Robinson DA, Binley A, Crook N, Day-Lewis FD, Ferré TPA, Grauch VJS, et al. Advancing process-based watershed hydrological research using near-surface geophysics: a vision for, and review of, electrical and magnetic geophysical methods. *Hydrological Processes*. 2008;22(18):3604-35.
59. Mulder VL, de Bruin S, Schaepman ME, Mayr TR. The use of remote sensing in soil and terrain mapping — A review. *Geoderma*. 2011;162(1):1-19.
60. Francioni M, Salvini R, Stead D, Coggan J. Improvements in the integration of remote sensing and rock slope modelling. *Natural Hazards*. 2018;90(2):975-1004.
61. Stead D, Donati D, Wolter A, Sturzenegger M. Application of Remote Sensing to the Investigation of Rock Slopes: Experience Gained and Lessons Learned. *ISPRS International Journal of Geo-Information*. 2019;8(7).
62. Kaamin M, Mohamad Shahr M, Madun A, Nur'ain I, Siti Noraiza Ab R, Ngadiman N, et al. Visual Slope Inspection using Unmanned Aerial Vehicle (UAV). *Journal of Physics: Conference Series*. 2020;1529(3).
63. Dick GJ, Eberhardt E, Cabrejo-Liévano AG, Stead D, Rose ND. Development of an early-warning time-of-failure analysis methodology for open-pit mine slopes utilizing ground-based slope stability radar monitoring data. *Canadian Geotechnical Journal*. 2014;52(4):515-29.
64. Toshioka T, Tsuchida T, Sasahara K. Application of GPR to detecting and mapping cracks in rock slopes. *Journal of Applied Geophysics*. 1995;33(1-3):119-24.
65. Gobesz Z. The Roots of Bim. *Műszaki Tudományok Közlemények*. 2020;12:42-9.
66. Volk R, Stengel J, Schultmann F. Building Information Modeling (BIM) for existing buildings — Literature review and future needs. *Automation in Construction*. 2014;38:109-27.
67. Eastman CM, Eastman C, Teicholz P, Sacks R, Liston K. *BIM handbook: A guide to building information modeling for owners, managers, designers, engineers and contractors*: John Wiley & Sons; 2011.

68. Eastman C, Teicholz P, Sacks R, Liston K. BIM for the Construction Industry. 2008. p. 207-42.
69. Papadonikolaki E, van Oel C, Kagioglou M. Organising and Managing boundaries: A structural view of collaboration with Building Information Modelling (BIM). *International Journal of Project Management*. 2019;37(3):378-94.
70. Lucas J, Bulbul T, Thabet W. An object-oriented model to support healthcare facility information management. *Automation in Construction*. 2013;31:281-91.
71. Farfán Tataje EZ, Chavil Pisfil JD. Análisis y evaluación de la implementación de la metodología bim en empresas peruanas. *Universidad Peruana de Ciencias Aplicadas (UPC)*; 2016.
72. Del Grosso A, Basso P, Ruffini L, Figini F, Cademartori M. Infrastructure management integrating SHM and BIM procedures 2017.
73. Rio J, Ferreira B, Poças Martins J. Expansion of IFC model with structural sensors. *Informes de la Construcción*. 2013;65(530):219-28.
74. Theiler M, Dragos K, Smarsly K, editors. BIM-based design of structural health monitoring systems 2017.
75. Shaffer WA. *Dynamo. SIMULATION*. 1980;34(4):134-6.
76. Angelosanti M, Debetwar S, Currá E, Sabato A. 3D-DIC analysis for BIM-oriented SHM of a lab-scale aluminium frame structure. *Journal of physics Conference series*. 2021;2041(1):12009.
77. Grieves M, Vickers J. Digital twin: Mitigating unpredictable, undesirable emergent behavior in complex systems. *Transdisciplinary perspectives on complex systems: Springer*; 2017. p. 85-113.
78. Glaessgen E, Stargel D, editors. The digital twin paradigm for future NASA and US Air Force vehicles 2012.
79. Muñoz Alcázar J. Aplicación del concepto de gemelo digital a un SCADA Industrial. 2019.
80. Batty M. Digital twins. *Environment and Planning B, Urban Analytics and City Science*. 2018;45(5):817-20.
81. Kritzinger W, Karner M, Traar G, Henjes J, Sihn W. Digital Twin in manufacturing: A categorical literature review and classification. *IFAC-PapersOnLine*. 2018;51(11):1016-22.
82. Gómez Moreno M. Desarrollo y validación experimental de un gemelo digital para un aerogenerador. 2021.
83. Álvarez-Requejo Heredero M. Estudio para la implementación de un gemelo digital en una fábrica de cerveza. 2021.
84. O'Shea M, Murphy J. Design of a BIM Integrated Structural Health Monitoring System for a Historic Offshore Lighthouse. *Buildings*. 2020;10(7).
85. Valinejadshoubi M, Bagchi A, Moselhi O. Development of a BIM-Based Data Management System for Structural Health Monitoring with Application to Modular Buildings: Case Study. *Journal of Computing in Civil Engineering*. 2019;33(3):05019003.
86. Cambridge Uo. Centre for Digital Built Britain 2020 [Available from: Centre for Digital Built Britain (cam.ac.uk)].
87. Caballero-Russi D, Ortiz AR, Guzmán A, Canchila C. Design and Validation of a Low-Cost Structural Health Monitoring System for Dynamic Characterization of Structures. *Applied Sciences*. 2022;12(6):2807.
88. Works OoP. Floodinfo.ie 2018 [Available from: <https://www.floodinfo.ie/>].
89. Jaboyedoff M, Oppikofer T, Abellán A, Derron M-H, Lloye A, Metzger R, et al. Use of LIDAR in landslide investigations: a review. *Natural Hazards*. 2012;61(1):5-28.
90. Othman I, Al-Ashmori YY, Rahmawati Y, Mugahed Amran YH, Al-Bared MAM. The level of Building Information Modelling (BIM) Implementation in Malaysia. *Ain Shams Engineering Journal*. 2021;12(1):455-63.
91. Tawelian LR, Mickovski SB. The Implementation of Geotechnical Data into the BIM Process. *Procedia Engineering*. 2016;143:734-41.

92. Labuz JF, Zang A. Mohr–Coulomb Failure Criterion. Rock Mechanics and Rock Engineering. 2012;45(6):975-9.
93. Leica Geosystems 2022 [Available from: <https://leica-geosystems.com/products/laser-scanners/software/leica-cyclone/leica-cyclone-3dr>].
94. Pix4DCapture [Available from: <https://surveydrones.ie/pix4dsoftware/pix4d-capture-2/>].
95. SenseFly 2022 [Available from: <https://www.sensefly.com/software/pix4d/>].
96. Numpy Python [Available from: <https://numpy.org/>].
97. Open3D [Available from: <http://www.open3d.org/>].
98. MatPLOLib [Available from: <https://matplotlib.org/>].
99. Oauth2client [Available from: <https://oauth2client.readthedocs.io/en/latest/>].
100. Gspread 2022 [Available from: <https://docs.gspread.org/en/latest/>].
101. Smarsly K, Theiler M, Dragos K. IFC-based modeling of cyber-physical systems in civil engineering2017.
102. LandarchBIM. Elk Mapping in Dynamo 2015 [Available from: <https://landarchbim.com/2015/12/01/elk-mapping-in-dynamo/>].

## Image References

1. O'Shea M. Cobh Landslides Prevention Programme Retaining Wall Monitoring Programme Survey Report No. 2. 2016.
2. Cobh V. Cobh, Great Island 2009 [Available from: <http://www.visitcobh.com/index.php/photo-gallery/>].
3. Partners MWA. Cobh Landslides Project Cork 2012 [Available from: <https://www.mwp.ie/project/cobh-landslides/>].
4. GSI GS-. Landslide Susceptibility Map Viewer [Available from: <https://dceur.maps.arcgis.com/apps/webappviewer/index.html?id=b68cf1e4a9044a5981f950e9b9c5625c>].
5. Pines D, Aktan AE. Status of structural health monitoring of long-span bridges in the United States. *Progress in Structural Engineering and Materials*. 2002;4(4):372-80.
6. Oliveira S, Alegre A. Seismic and structural health monitoring of Cabril dam. *Software development for informed management. Journal of Civil Structural Health Monitoring*. 2020;10(5):913-25.
7. Ni YQ, Xia Y, Liao WY, Ko JM. Technology innovation in developing the structural health monitoring system for Guangzhou New TV Tower. *Structural Control and Health Monitoring*. 2009;16(1):73-98.
8. Tom Rune L. Rockslide Mapping in Norway by Means of Interferometric SAR Time Series Analysis. 2011.
9. Jaboyedoff M, Oppikofer T, Abellan A, Derron M-H, Alexandre L, Metzger R, et al. Use of LIDAR in landslide investigations: A review. *Nat Hazards*. 2012;61:5-28.
10. Oliva González A. Instrumentación y control de taludes y laderas 2015.
11. Geomechanics FMI. [Available from: <https://www.field-monitoring.org/inclinometer>].
12. Whiteley J, Chambers J, Uhlemann S, Wilkinson P, Kendall J. Geophysical Monitoring of Moisture-Induced Landslides: A Review. *Reviews of Geophysics*. 2019;57.
13. Wingtra. Surveying & GIS [Available from: <https://wingtra.com/drone-mapping-applications/surveying-gis/>].
14. Taillade Fdr, Quiertant M, Benzarti K, Dumoulin J, Aubagnac C. Nondestructive Evaluation of FRP Strengthening Systems Bonded on RC Structures Using Pulsed Stimulated Infrared Thermography. 2012.
15. Geograph Ireland 2012 [Available from: <https://www.geograph.ie/>].
16. Design E. Leica MultiStation MS60: Scanning and Self-Learning for Precise Tasks 2018 [Available from: <https://www.ecedesign.com/leica-scanning-software/scanners/leica-multistation/>].
17. DJI. DJI [Available from: <https://www.dji.com/ie>].
18. Plank T. The Digital Twin – an introduction. LinkedIn. 2019.
19. Google. Google Maps [Available from: <https://www.google.ie/maps?hl=es&authuser=0>].
20. Arduino. Arduino Products [Available from: <https://www.arduino.cc/>].
21. Huawei. Huawei Products [Available from: <https://consumer.huawei.com/>].
22. Mechatronics N. NayLamp Mechatronics [Available from: [https://naylampmechatronics.com/blog/45\\_tutorial-mpu6050-acelerometro-y-giroscopio.html](https://naylampmechatronics.com/blog/45_tutorial-mpu6050-acelerometro-y-giroscopio.html)].