

**UCC Library and UCC researchers have made this item openly available.
 Please [let us know](#) how this has helped you. Thanks!**

Title	Coherent techniques and deformable-mirror device (DMD)-based switched photonic time delay control for high frequency antenna arrays
Author(s)	Riza, Nabeel A.
Publication date	1997-10-23
Original citation	Riza, N. A. (1997) 'Coherent techniques and deformable-mirror device (DMD)-based switched photonic time delay control for high frequency antenna arrays', Proceedings of SPIE, 3160, Optical Technology for Microwave Applications VIII, Optical Science, Engineering and Instrumentation '97 San Diego, CA, USA. doi: 10.1117/12.283934
Type of publication	Conference item
Link to publisher's version	http://dx.doi.org/10.1117/12.283934 Access to the full text of the published version may require a subscription.
Rights	© 1997 Society of Photo-Optical Instrumentation Engineers (SPIE). One print or electronic copy may be made for personal use only. Systematic reproduction and distribution, duplication of any material in this paper for a fee or for commercial purposes, or modification of the content of the paper are prohibited.
Item downloaded from	http://hdl.handle.net/10468/10177

Downloaded on 2021-09-27T11:03:29Z

PROCEEDINGS OF SPIE

[SPIDigitalLibrary.org/conference-proceedings-of-spie](https://spiedigitallibrary.org/conference-proceedings-of-spie)

Coherent techniques and digital-micromirror-device-based switched photonic time delay control for high-frequency antenna arrays

Riza, Nabeel

Nabeel A. Riza, "Coherent techniques and digital-micromirror-device-based switched photonic time delay control for high-frequency antenna arrays," Proc. SPIE 3160, Optical Technology for Microwave Applications VIII, (23 October 1997); doi: 10.1117/12.283934

SPIE.

Event: Optical Science, Engineering and Instrumentation '97, 1997, San Diego, CA, United States

Coherent Techniques and Digital Micromirror Device based Switched Photonic Time Delay Control for High-Frequency Antenna Arrays

Nabeel A. Riza*

Center for Research and Education in Optics and Lasers (CREOL)
and the Department of Electrical and Computer Engineering
University of Central Florida,
4000 Central Florida Blvd., Orlando, FL 32816-2700

ABSTRACT

Two photonic delay line structures are introduced that are based on the binary operation of Digital Micromirror Devices (DMDs). These structures include a binary switched design based on multiple DMDs, and a non-binary delay line design using a single DMD. These DMD-based delay lines do not require polarized light for operation.

Keywords: Digital Micromirror Device (DMD), Fourier Transform Lens, Photonic Delay Line

1. INTRODUCTION

Over the last decade, extensive work has been done to realize high performance photonic delay lines (PDLs), particularly for the wideband phased array antenna control application [1]. Various technologies have been proposed for realizing switched PDLs including nematic liquid crystals, ferroelectric liquid crystals, acousto-optics, and lithium niobate integrated-optics. In most cases, these PDL structures require polarized light for operation, hence polarization controllers must be used in conjunction with these PDLs. Another approach is to design a polarization independent PDL structure at the expense of using additional optical components. Hence, it would be desirable to have a PDL structure that does not require polarized light for operation. Applications for such a PDL can range from fiber-optically fed photonic signal processing for radio frequency (RF) applications to adaptive optical processing for laser radar and astronomical telescopic arrays. In this paper, we show how the recently introduced Texas Instruments (TI) DMD can be used to form polarization insensitive PDLs.

2. THE TI DMD AND ITS BASIC OPERATION

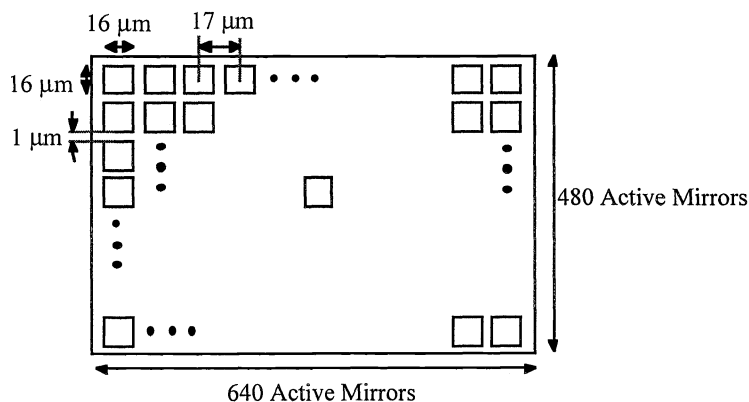

Fig.1: Shows the DMD pixel layout.

* N.A. Riza: E-mail: riza@creol.ucf.edu; Telephone: 407-823-6829; Fax: 407-823-3354

Listed below are the TI DMD Specifications. Fig.1 shows the DMD pixel layout.

- Total Mirrors on Device: 508,800
- Mirror Size: $16\ \mu\text{m} \times 16\ \mu\text{m}$; Inter-Mirror Gap: $1\ \mu\text{m}$; Pixel Pitch: $17\ \mu\text{m}$
- Mirror/Pixel Switching Time: $15\ \mu\text{sec}$
- Device Optical Efficiency: $\sim 62\%$ Limited Due to Fill Factor, Mirror Reflectivity, and Device Diffraction Structure
- Mirror Active States: 2 ($+10^\circ$ and -10° Mirror Positions)

Note that this device was originally designed for color projection display applications with video frame rate operation for the 0.5 million pixels that make up a high quality VGA format color image. From a single mirror drive point-of-view, each mirror/pixel can be set at a rather fast $15\ \mu\text{s}$ switching time. Hence, the number of mirrors in the DMD that a PDL requires to reset its time delay setting will dictate the overall PDL switching time.

Note that the TI-DMD is specified as a binary device with only two electronically operational modes. These are the $+10^\circ$ State and -10° State as shown in Fig.2.

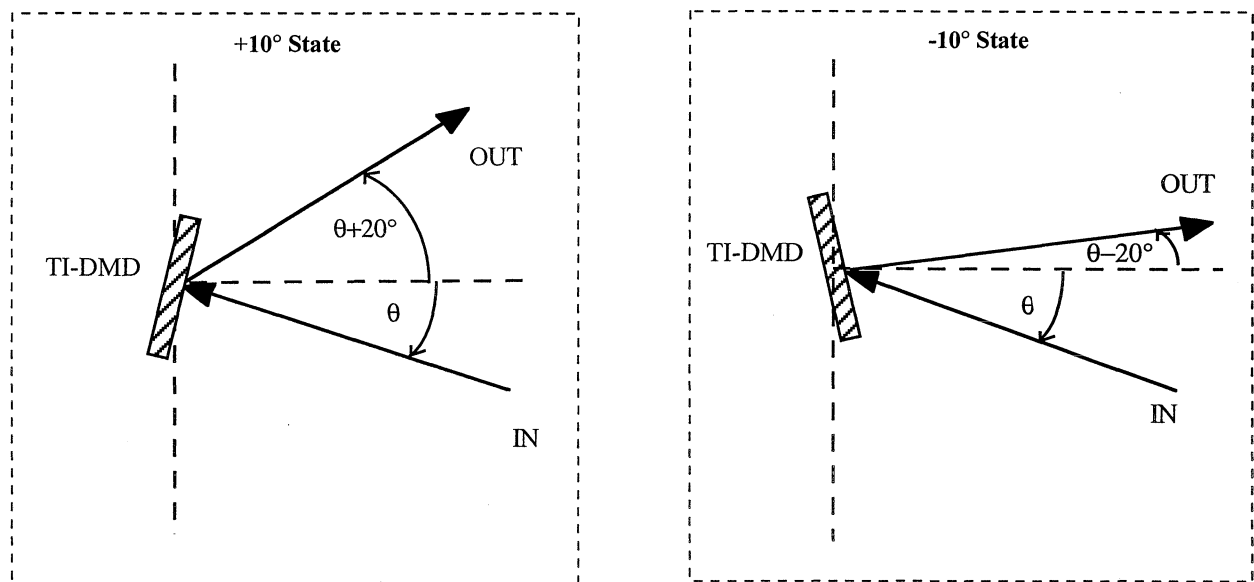
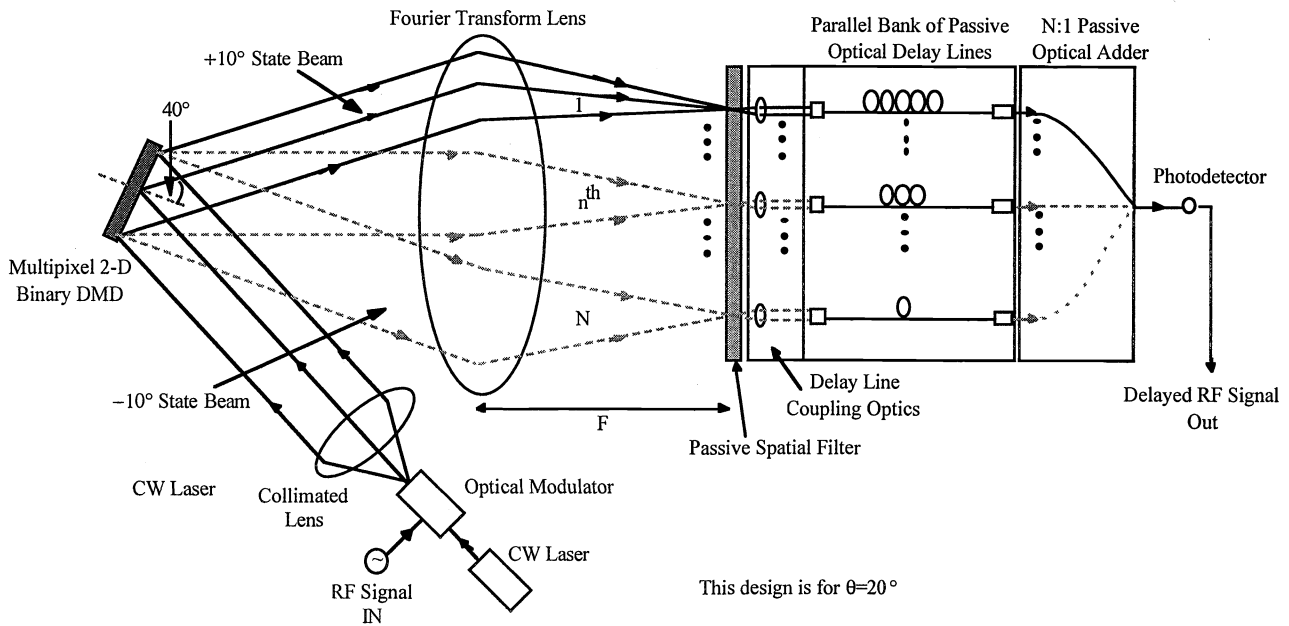

Fig.2: Shows the $+10^\circ$ State and -10° State of the TI-DMD as specified by TI. Hence, as indicated, the DMD acts as a binary device with only two electronically operational modes.

3. DMD FOURIER TRANSFORM PHOTONIC DELAY LINE -- NON-BINARY ARCHITECTURE

Fig.3 shows the proposed DMD Fourier transform PDL non-binary architecture. Coherent light from a modulated laser source strikes the DMD, and a Fourier transform spherical lens takes this incident light and sends it to one of the N-ports of the parallel bank of pre-cut fiber-based delay segments. As the DMD is specified to operate as a binary reflective device, it can act as an amplitude-only spatial light modulator, where macro-pixels containing many binary state pixels are used to form a gray-scale reflectance. Hence, a spatial filter is required before the fiber coupling ports to block light from the unwanted diffraction orders. Because this TI-DMD has over 0.5 M pixels, the large space bandwidth product of the device can be used to generate a reasonably large (e.g., $N=32$) light beam deflection points that would correspond to a 32-state PDL. A final N:1 optical combiner is used to redirect the delayed light to a single fixed output port.



F: Focal length of Fourier Transform Lens, 1: All DMD Pixels at +10° state, n^{th} : Some DMD Pixels at +10° state Some at -10° state
 N: All DMD Pixels at -10° state

Fig.3: The DMD Fourier Transform Photonic Delay Line Non-Binary Architecture.

The key feature of this non-binary architecture DMD Fourier transform PDL is that it is a single compact unit using only one DMD. Nevertheless, its key limitations are that it is a non-binary optical design that limits the maximum number of possible time delays. In addition, the binary amplitude-only modulation nature of the binary TI-DMD limits optical diffraction efficiency and hence the light throughput of the PDL unit.

4. THE DMD RAY-OPTICS PHOTONIC DELAY LINE -- BINARY ARCHITECTURE

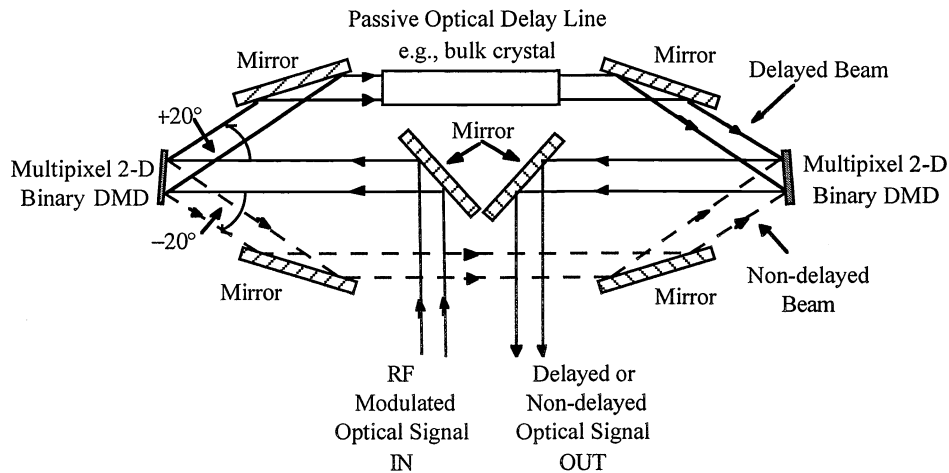

Fig.4: Shows the DMD Ray-Optics Photonic Delay Line Binary Architecture.

A more efficient PDL design is the binary switched architecture where the cascade of N binary switching units gives 2^N different time delay settings. Fig.4 shows this binary architecture using our DMD Ray-Optics PDL approach. In this case, the DMD is used as a binary device which is inherent in its device design. Hence, no gray-scale operation is required, and thus a high light efficiency single bit delay line is formed. By cascading several of these single bit modules, a N -bit PDL can be formed. No coherent optics features of the components are used in this PDL. Instead, a ray or geometrical optics approach using mirrors is used for optical beam switching, path selection, and beam combining.

The key features of this binary architecture DMD Ray-Optics PDL are: (a) No high quality coherent-optics is required, (b) Binary operation of DMD improves optical throughput efficiency, and (c) cascading of binary PDL units produces N -bit PDL with more time delay settings. The key limitation of this binary architecture DMD Ray-Optics PDL is that it requires “ $2N$ ” DMDs for a N -bit PDL.

5. DMD RAY-OPTICS PHOTONIC DELAY LINE--MULTICHANNEL ARCHITECTURE

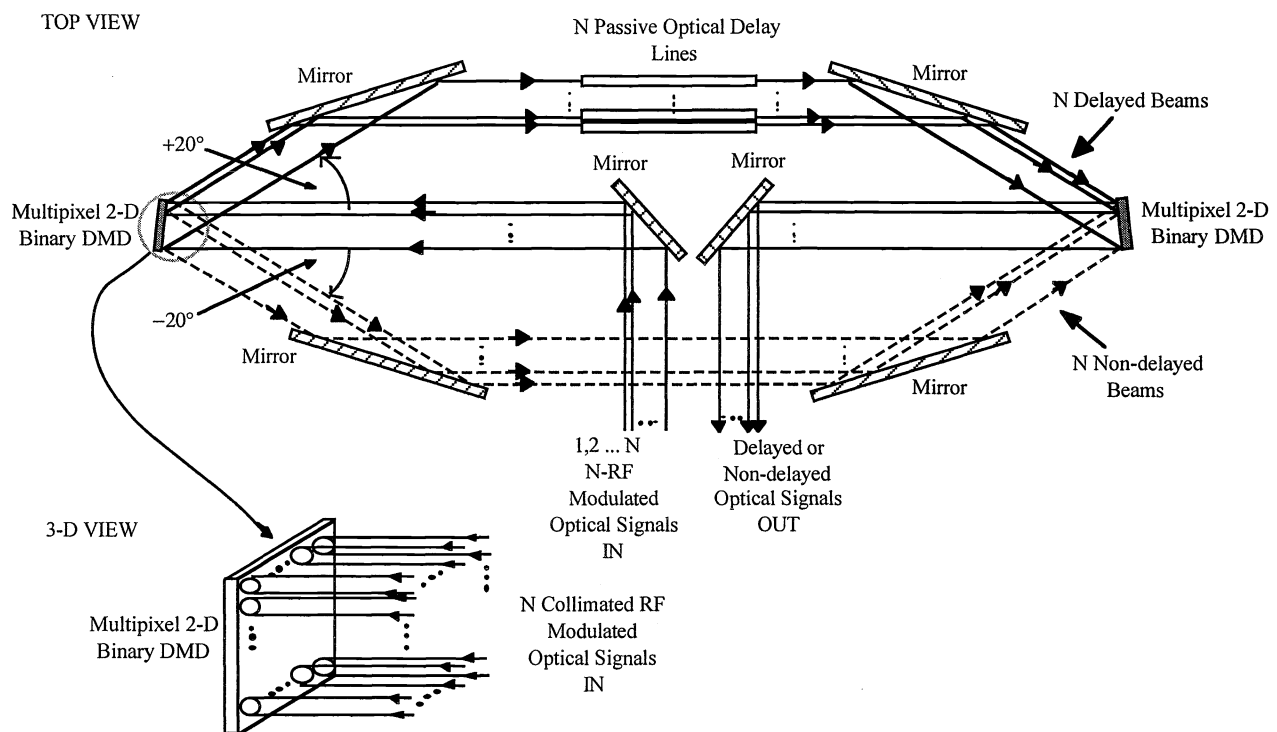

Fig.5: Shows how a Multichannel PDL based on our Basic Single Channel DMD Ray-Optics PDL Design.

Fig.5 shows how via a simple modification in optics, a multichannel PDL can be formed using our basic DMD-based single channel ray-optics PDL design. This multichannel PDL design is particularly suited for array signal processing where simultaneous channels are required for time delay signal processing.

6. THE BINARY ARCHITECTURE DMD RAY-OPTICS PDL-- BASIC EXPERIMENT

As shown in Fig.6, we setup our PDL using the TI-DMD. The most basic 1-Bit PDL binary structure is set-up to study the quality of this type of PDL. Instead of the output port combining mirrors and an additional DMD, a lens is used at the output for optical combining as no bit-to-bit cascading is intended for this system. Direct visible light optical measurements are taken with a photodetector to study the signal-to-noise ratio of this 1-bit PDL. Signal is defined as the light that travels through the desired delay or non-delay optical path, while noise includes leakage light and any other unwanted light such as from scattering and pixel grid-structure diffraction effects.

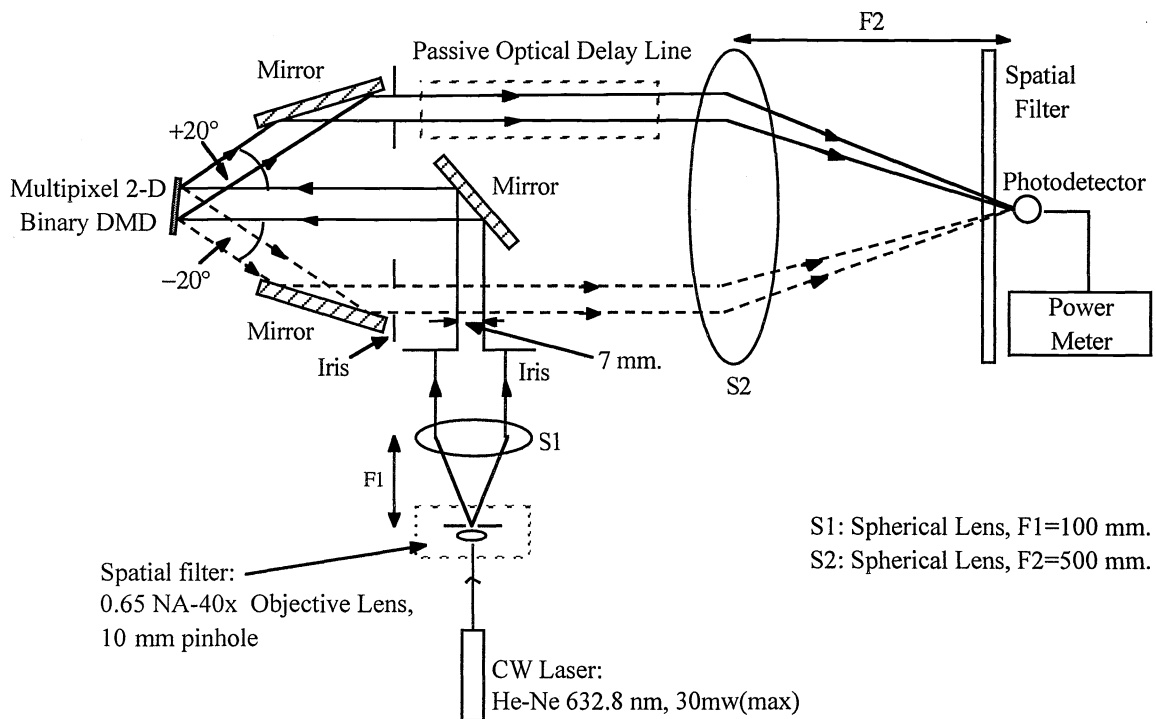

Fig.6: Shows the Laboratory Experimental Setup of our Basic Single Channel DMD Ray-Optics PDL Design.

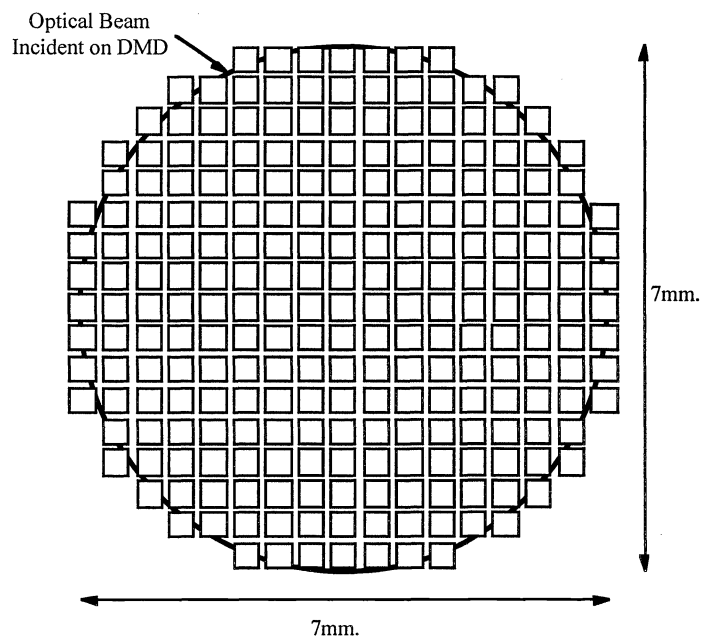

Fig.7: Shows the Optically Activated Region containing ≈ 133164 Pixels in the DMD.

Table 1 shows the optical and electrical signal-to-noise ratio measurements obtained from our laboratory binary 1-bit DMD Ray-Optics PDL unit. These preliminary results indicate a > 30 dB electrical signal-to-noise ratio. Further improvements are expected by using antireflection coated optics and better noise reduction methods.

Table 1: Experimental Results

	Optical SNR dB	Electrical SNR dB
Setting 1 (+10° State, Delay)	15.7 \leftrightarrow (37:1)	31.4
Setting 2 (-10° State, Non-Delay)	17.3 \leftrightarrow (53:1)	34.6

In conclusion, we have introduced two novel photonic delay lines using the TI-DMD. The basis of the first non-binary PDL design is Fourier optics and spatial filtering, while the second binary design uses geometrical optics and mirrors for path switching and selection. The non-binary PDL uses a single DMD as a gray-scale SLM while the binary 1-bit PDL unit uses two DMDs/bit or 2N DMDs for a N-bit PDL. Our preliminary experiments using the TI-DMD to form the binary DMD Ray-Optics PDL 1-bit structure has demonstrated > 30 dB electrical signal-to-noise ratios (SNRs). To the best of the authors knowledge, these PDLs are the first PDL structures using the TI “*Digital Micromirror Device.*”

7. INCOHERENT OPTICAL BEAMFORMING STRUCTURES AND COHERENT TECHNIQUES

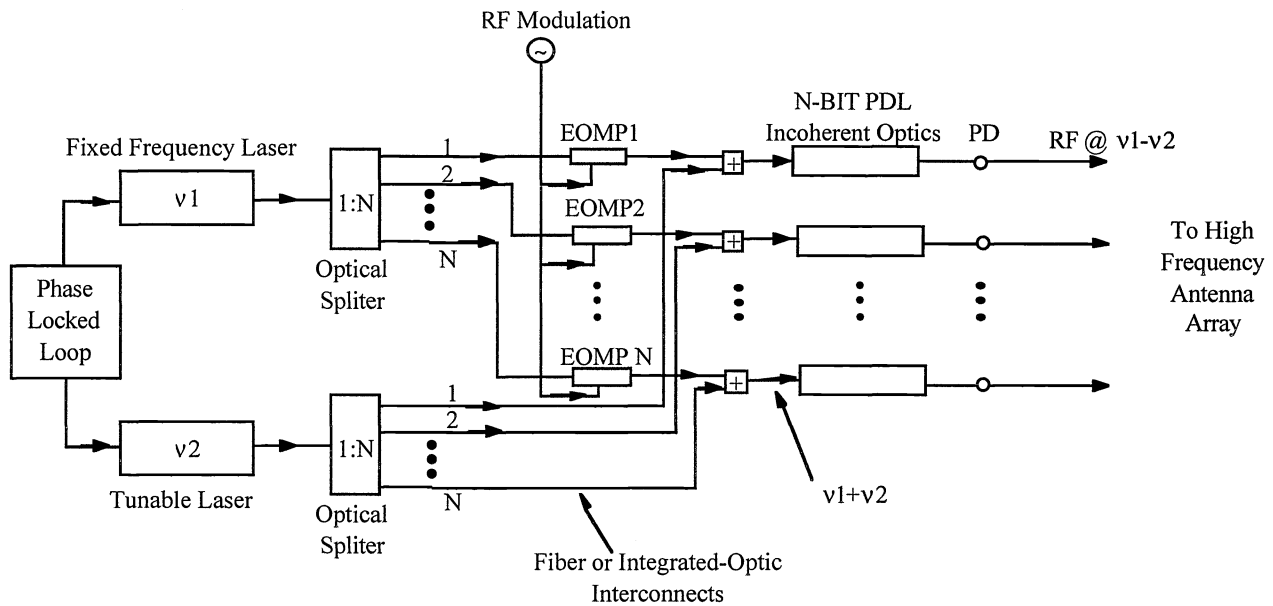

EOMP: Electro-Optic Phase Modulator modulated @ Low RF
PDL: Photonic Delay Line
PD: Photodetector (using heterodyne detection method)

Fig.8: Shows Our Incoherent Optics PDL Structure Using Coherent Input and Output Optics for Ultra-High Frequency Millimeter Wave Band Beamforming Applications.

Our prior work on PDLs has been limited to ~ 18 GHz, as we used incoherent or intensity modulation of light beams as inputs to our PDL. This frequency limit was imposed because commercial electro-optic modulators have limited bandwidths for direct intensity modulation of input light beams. Our PDLs are based on incoherent optical structures that do not require high optical quality optics across all the optical channels in a multichannel PDL design. These PDL structures also use direct optical detection of light at their output ports. For applications in millimeter wave communication antennas and radars, we need to extend our PDLs to these higher frequency bands. We suggest the use of well-known coherent optical modulation and detection techniques with our incoherent PDL optical structures to realize this system scenario. Fig.8 shows the basic building blocks of this millimeter wave band PDL-based antenna beamforming system. Our future work will demonstrate this system.

ACKNOWLEDGMENTS

The author would like to acknowledge experimental support from graduate student Sarun Sumriddetchkajorn.

REFERENCES

1. N. A. Riza, Editor, *Selected Papers on Photonic Control Systems for Phased Array Antennas, SPIE Milestone Series, Vol. MS136*, June, 1997.