

Title	EESD2021: Proceedings of the 10th Engineering Education for Sustainable Development Conference, 'Building Flourishing Communities'
Publication date	2021-06
Original Citation	Byrne, E. (ed.) EESD2021: Proceedings of the 10th Engineering Education for Sustainable Development Conference, 'Building Flourishing Communities', University College Cork, Ireland, 14-16 June. https://www.eesd2020.org/
Type of publication	Conference item
Link to publisher's version	https://www.eesd2020.org/ , https://cora.ucc.ie/handle/10468/11460
Rights	© 2021, the Author(s). This work is licensed under a Creative Commons Attribution-NonCommercial-NoDerivatives 4.0 International License - https://creativecommons.org/licenses/by-nc-nd/4.0/
Download date	2024-04-27 14:03:45
Item downloaded from	https://hdl.handle.net/10468/11459

Proceedings
of the
**10th Engineering Education for Sustainable
Development Conference**
'Building Flourishing Communities'



EESD2021

BUILDING FLOURISHING COMMUNITIES

Proceedings of the
10th Engineering Education for Sustainable
Development Conference (EESD2021)
'Building Flourishing Communities'



University College Cork, Ireland

14-16 June 2021

<https://www.eesd2020.org/>

Introduction

We are delighted to present here the *Proceedings of the 10th Engineering Education for Sustainable Development* conference, themed '*Building Flourishing Communities*'. The 10th EESD represents a number of firsts; the first time the conference has been held on the island of Ireland, at University College Cork, a university with a long, proud and green heritage, and it is also the first time the conference has been held in virtual form. This also required two pivots; first from its original designation as EESD2020 (as borne out by the conference website: <https://www.eesd2020.org/>), and secondly from a physical conference to an virtual one.

To that end, we'd like to thank our colleagues at UCC Conferences, in particular Michael Kenneally and Sian James, for their assistance to enable us offer a virtual UCC and Cork welcome to delegates via a suitable platform, while enabling at least some of the usual EESD dialogue, reflection and inspiration!

A big thanks also goes to EESD2021 local organising committee members for helping realise this publication, in particular to John Barrett, who provided technical support for EESD2021 and put these proceedings together, to Dr John Fitzpatrick, who painstakingly oversaw two iterations of abstract and paper submission and peer reviews cycles, culminating in the 63 papers included here. The conference would not have been possible either without the tireless work over three years of Claudia Cashman, who as EESD2021 Conference Manager helped tie it all together.

Thanks too to our conference sponsors and partners; ESB, AbbVie, Fáilte Ireland (do come visit us in UCC and Cork!), the National Forum for the enhancement of Teaching and Learning in Higher Education, and Cork County Council.

The biggest thanks goes to the authors contained within these proceedings, all 160 plus of you, from 16 countries across five continents. A big thank you is deserved for your time, effort and patience in researching and drawing together these papers, and then presenting, animating and discussing them at EESD2021 – in most cases well over a year after submission. Your work has significantly added to the proud and rich tradition of EESD, one which stretches back to the turn of the century, but whose import has never been more critical. As the old Gaelic saying goes: *Ní neart go cur le chéile!* – *Only together can we make progress!*

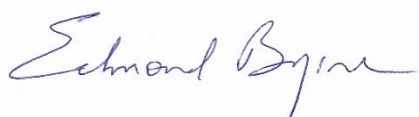

Edmond Byrne

Chair, EESD2021



Table of Contents - Index

Page No

EESD2021 Programme	1
Data Mining for Sustainability Analytics: An Educational Approach [70] <i>Mustafa Al Tekreeti, Salwa Beheiry, Ayman Alzaatreh, American U. Sharjah, UAE</i>	9
Social and Ecological Responsibility within Engineering Education. A Modular Student-Driven Course Design that is Implemented at Seven German Universities [41] <i>André Baier, TU Berlin, Germany</i>	19
Connecting the Dots: Understanding Professional Development Needs of Istanbul’s Makers for Circular Economy through Distributed Fabrication [72] <i>Yekta Bakırlioğlu [1,2], Maria-Laura Ester Ramirez Galleguillos [1], Ivon Bensason [1], Asım Evren Yantaç [1], Aykut Coşkun [1], Koç U., Turkey, Middle East Technical U., Turkey</i>	27
National Forum for Teaching & Learning Research Spotlight: Integrating the U.N. Sustainable Development Goals into a Connected Curriculum Framework at University College Cork <i>John Barimo, Catherine O’Mahony, Gerard Mullally, Edmond Byrne, John O’Halloran, Darren Reidy and Maria Kirrane, UCC, Ireland</i>	36
Identifying Students’ Sustainability Preferences to Improve Design Team Performance [27] <i>Elise Barrella [1], Justyn Girdner [2], Robin Anderson [2], Mary Katherine Watson [3]. [1] Wake Forest U., NC, USA, [2] James Madison U., VA, USA, [3] The Citadel, SC, USA</i>	37
‘Storying Architecture’ Pilot Study; Trial and Tribulation. Detailing the Methodology, Implementation, and Initial Findings of a Postponed Research Project in Bali, Indonesia. [80] <i>Alastair Brook, UCC, Ireland</i>	45
Innovation Clubs: Mobilizing Local Creativity for Sustainable Development and Pedagogy [7] <i>Christianos Burlotos, Tracy Kijewski-Correa, Alexandros Taflanidis, William Cunningham. U. Notre Dame, USA</i>	57
How do Graduate Civil Engineers Working in London Enact Global Responsibility and Support UN Sustainable Development Goals? [28] <i>Shannon Chance [1,2], Inês Direito [1], John Mitchell [1]. [1] UCL, UK, [2] TU Dublin, Ireland</i>	65
Industry 4.0 as an Enabler for Sustainable Manufacturing: - An Educational Perspective [15] <i>Caoimhe Coleman, Sara Abu Selmia, Ingrid Carla Reinhardt, Jorge Oliveira, Denis Ring, UCC, Ireland</i>	73
Re-Structuring Practice for Sustainability: Learning from Case Studies [91] <i>Stefani Danes, Carnegie Mellon U., Craig Stevenson, Auros, USA</i>	82
Engineers as advocates for Sustainable Development: countering misinformation and the need for Aristotelian Rhetoric [9] <i>Richard Fenner, U. Cambridge, UK</i>	90
The Barcelona Declaration revisited: core themes and new challenges <i>Richard Fenner, David Morgan, U. Cambridge, UK</i>	100
Non-Discipline Specific Sustainability Knowledge & Competences in the Chemical Engineering Programme at UCC [2] <i>John Fitzpatrick, Edmond Byrne, UCC, Ireland</i>	112

The Contemporary Engineer: Developing Sustainability Competences and Transferable Skills through Open-ended Activities [4] <i>John Fitzpatrick, Edmond Byrne, UCC, Ireland Francisco Javier Gutiérrez Ortiz, U. Seville, Spain</i>	120
A Sustainable Technologies Certificate Designed for Engineering and Engineering Technology Students (EESD2020) [8] <i>Patricia Fox, Charles McIntyre, Indiana U.-Purdue U, USA</i>	128
Towards a Sustainability-Centred Design Curriculum in Civil Engineering [20] <i>Thomas Froese [1], David Bristow [1], Keagan Rankin [2]. [1] U. Victoria, BC, [2] U. New Brunswick, Canada</i>	135
Using field trips in engineering education to facilitate the understanding of energy systems, technologies and transitions: an overview [81] <i>Lukas T. Gast, U. Cambridge, UK</i>	143
Embedding Sustainability in Engineering Education through Interactive Industrial Design Case Studies [38] <i>Kevin Gibson, Jorge Oliveira, Denis Ring, UCC, Ireland</i>	152
A Proposal for Linking Origami Art in Robotics Engineering Education [12] <i>Guangbo Hao [1], Alex Pentek [2]. [1] UCC, Ireland, [2] National Sculpture Factory, Ireland</i>	160
Global Perspectives on Electric Vehicle Education: Part I [68] <i>John Hayes [1], Yue Cao [2], Xinmei Yang [3], Jessica Suda [4], Xiaofeng Yang [5], Jens Friebe [6], Osmar Ogashawara [7], John Renie [8], G.A. Goodarzi [9]. [1] UCC, Ireland, [2] Oregon St. U, OR, USA [3] Jilin U, China, [4] Southern Illinois U, IL, USA, [5] Beijing Jiaotong U, China, [6] Leibniz U., Germany, [7] U. Fed. de Sao Carlos, Brazil, [8] Indiana IT, IN, USA [9] US Hybrid Corp., CA, USA</i>	168
Global Perspectives on Electric Vehicle Education: Part II [69] <i>John Hayes [1], Yue Cao [2], Xinmei Yang [3], Jessica Suda [4], Xiaofeng Yang [5], Jens Friebe [6], Osmar Ogashawara [7], John Renie [8], G.A. Goodarzi [9]. [1] UCC, Ireland, [2] Oregon St. U, OR, USA [3] Jilin U, China, [4] Southern Illinois U, IL, USA, [5] Beijing Jiaotong U, China, [6] Leibniz U., Germany, [7] U. Fed. de Sao Carlos, Brazil, [8] Indiana IT, IN, USA [9] US Hybrid Corp., CA, USA</i>	176
Perspectives on Challenge Driven Education for future Engineering education [107] <i>J. Hedvall, H. Lindberg, A. Rosén, Lena Gumaelius, KTH, Sweden</i>	184
Urban agriculture and its applications for office buildings in large urban areas in Vietnam [21] <i>Hai-Yen Hoang, Ho Chi Minh City U. of Technology, Vietnam</i>	192
Application of CDIO Standard for teaching the Architectural Composition Subject with a practice competition about green architecture at Ho Chi Minh City University of Technology, Vietnam [37] <i>Hai-Yen Hoang, Ho Chi Minh City U. of Technology, Vietnam</i>	202
Developing Inclusive and Sustainable Curriculum for Environmental Engineering Courses [47] <i>Kauser Jahan, Sarah Bauer, Jagadish Torlapati, Tiago Forin, Rowan U., USA</i>	214
Engineering Mechanics and Sustainable Engineering [75] <i>Nand Jha, Manhattan College, USA</i>	222

	Page No
Engineering Education for a Zero Growth Economy [5] <i>Gearold Johnson, Thomas Siller, Colorado St..U, USA</i>	239
A Novel Pedagogical Approach to Teaching Climate Change and Ethics [77] <i>Alandra Kahl, Penn State Greater Allegheny, USA</i>	244
Embedding Sustainability across the Built Environment Curriculum and Beyond [88] <i>Mark Kelly, GMIT, Ireland</i>	248
E-Mining@School; A Cross-Curricular Initiative To Embed Sustainability In The Junior Cycle Curriculum [31] <i>Lisa Kiely [1], Jude Sherry [2], Colin Fitzpatrick [2]. [1] Castletroy College, [2] U. Limerick, Ireland</i>	263
Teaching circular economy: Discussing limitations and opportunities of teaching about sustainable production [84] <i>Helen Kopnina, The Hague U. Applied Sciences, The Netherlands</i>	272
Using an open course pack to support interdisciplinary learning in Sustainable Energy Engineering [100] <i>Kamaria Kuling, Taco Niet, Sheena Miao Ying Tan, Simon Fraser U., Canada</i>	281
Engineering Accreditation Objectives and their Relationship to the Quality Assurance Standards for Engineering Education Programmes in Ireland [90] <i>Maria Kyne, Limerick I.T., Ireland</i>	289
What works? Sustainability Grand Challenges in Engineering Curricula via Experiential Learning [23] <i>Amy Landis [1], Claire Dancz [2], Kristen Parrish [3], Melissa Bilec [4]. [1] Colorado School of Mines, CO. [2] Clemson University, SC, [3] Arizona St. U., AZ, [4] U. Pittsburgh, PA, USA</i>	297
Educating Engineers for the post-COVID 21st Century [106] <i>Paul Leahy [1], Dylan Furszyfer [2,3], Benjamin Sovacool [3], Aoife M. Foley [2]. [1] UCC, R. Ireland, [2] QUB, N. Ireland, [3] SPRU, U. Sussex, UK</i>	303
Approximating Professional Practice in a First-Year Engineering Curriculum: The Wind Turbine Maker Project [99] <i>Paul Leahy, Connor McGookin, Hannah Daly, UCC, Ireland</i>	304
Closing the Circularity Gap Via Engineering Education for Circularity with a Whole Systems and Biomimetic Perspective [34] <i>Ross Lee, Karl Schmidt, Villanova U., USA</i>	312
Strategic implementation of education for sustainable development within the industrial engineer curriculum [57] <i>Nuria Llaverias, Guillermo Reyes, U. Ramon Llull, Spain</i>	320
Case studies in professional-oriented education: engaging with sustainability and complexity [48] <i>Kristen MacAskill, U. Cambridge, Catherine Tilley, King's College London, UK</i>	328
Integrating ethics across the curriculum through sustainability topics[17] <i>Diana Adela Martin[1,2], Eddie Conlon[1], Brian Bowe[1]. [1] TU Dublin, Ireland, [2] TU Eindhoven, The Netherlands</i>	336

	Page No
Transdisciplinarity in a bio-engineering course [103] <i>Valerie Massardier, Sébastien Livi, INSA Lyon, France</i>	344
Eco-design, circular economy & social responsibility [89] <i>Valerie Massardier, Corinne Subai, INSA Lyon, France</i>	350
Combining Sustainable Design Education with Research on Zero Energy Building Standards in Historic Buildings [104] <i>Kevin McCartney [1,2], Kevin Busby [1,3].</i> <i>[1] Centre for Architectural Education, [2] UCC, [3] Munster Technological University, Ireland</i>	355
Walking the walk; meaningfully engaging people with engineering challenges [24] <i>Connor McGookin, Brian Ó Gallachóir, Edmond Byrne, UCC, Ireland</i>	363
Birr Community School – A Case Study in Retrofitting and Conserving Modern Architecture [105] <i>John McLaughlin, UCC, Ireland</i>	371
How Cognitive Development Affects Student Perception by Threading Sustainability through Civil and Environmental Engineering Curriculum [62] <i>Jennifer Mueller, Rose-Hulman I.T., USA</i>	379
Education for Sustainability: Rethinking Digital Teaching and Learning Strategy [102] <i>Morag Munro, Maynooth U., Ireland</i>	386
Designing Laboratory Experiments for Electricity Grid Integration of Renewable Energy using Microgrid, Test-Rig Emulators and Real Time Simulation Tools [44] <i>Donal Murray, Nuh Erdogan, Alparslan Zehir, Barry Hayes, UCC, Ireland</i>	394
One Assignment, Two Courses, Multiple Skills: A Major Engineering Assignment with Social, Political and Ethical Dimensions [52] <i>Vivian Neal, Taco Niet, Simon Fraser U., Canada</i>	402
Exploring Transdisciplinary Education? [30] <i>Susan Nesbit [1], Naoko Ellis [1], Stefani Danes [2], Tanya Tan [1], Edmond Byrne [3],</i> <i>David Morgan [4], Javier Orozco-Messana [5].</i> <i>[1] UBC, Canada, [2] Carnegie Mellon U, PA, USA, [3] UCC, Ireland, [4] U. Cambridge, UK,</i> <i>[5] UP de Valencia, Spain</i>	410
Mind-mapping for Interdisciplinary Sustainable Architecture [3] <i>Javier Orozco-Messana, Universitat Politècnica de València, Spain</i>	420
Crossing technical and non-technical skills: French case studies in engineering training [39] <i>Catherine Perpignan [1], Yacine Baouch [1], Vincent Robin [2], Benoit Eynard [1].</i> <i>[1] U. Compiègne, [2] U. Bordeaux, France</i>	427
Higher Education Approaches to Engender Students' Environmental Consciousness in Electronic Device Design [32] <i>Sivakumar Ramachandran, IADT, Ireland</i>	435
Challenging energy engineering undergraduates with diverse perspectives on nuclear power [42] <i>Fionn Rogan, Hannah Daly, Paul Deane, James Glynn, Paul Leahy,</i> <i>Edmond Byrne, UCC, Ireland</i>	443

Excellence in education requires excellence in collaboration: learning modules in Circular economy as platforms for transdisciplinary learning [53] <i>Niclas Sandström [1], Anne Nevgi [1], Thomas Betten [2].</i> <i>[1] U. Helsinki, Finland, [2] Fraunhofer Inst. for Building Physics (IBP), Germany</i>	451
Circular Design project. Educating the Design Community in Sustainable Design [85] <i>Jordi Segalas[1], Adam de Eyto[2], Moireann McMahon[2], Yekta Bakirkioglu[2], Gemma Tejedor[1], Boris Lazzarini[1], Sine Celik[3], Alex Jimenez[4], Jonas Martins[5]</i> <i>[1] UPC-Barcelona, Spain, [2] U. Limerick, Ireland, [3] Stichting NHL, Netherlands, [4] Nut Creatives, Spain, [5] Ceci N'est Pas Une Holding B.V., Netherlands</i>	462
Sustainability Shares in the Classroom [33] <i>David Shallcross, U. Melbourne, Australia</i>	470
A New Course on Sustainable Innovation and Entrepreneurship [22] <i>Pritpal Singh, Villanova U., USA</i>	478
Sustainable Approaches to the Management of Innovation and Technology in Engineering (SAMITE II) [61] <i>Iain Stalker [1], Rinkal Desai [2], Rachel Studd [3].</i> <i>[1] U. Bolton, [2] U. Warwick, [3] The U. Manchester, UK</i>	485
Nature knows better? Nature as exemplar and/or inspiration? [65] <i>Laura Stevens [1], Karel Mulder [1,2], Helen Kopnina [2], Marc De Vries [1].</i> <i>[1] Delft UT, [2] The Hague U. Applied Sciences, The Netherlands</i>	493
Guidelines to improve Engineering Education for Sustainability through transdisciplinarity learning processes [93] <i>Gemma Tejedor, Jordi Segalas, UPC-Barcelona, Spain</i>	501
Challenge Driven Education for sustainability in engineering. A White Paper [94] <i>Gemma Tejedor [1], Anna-Karin Högfeldt [2], Jordi Segalas[1], Lena Gumaelius[2].</i> <i>[1] UPC-Barcelona, Spain. [2] KTH, Sweden</i>	509
Challenging Practice Traditions to Embed Education for Sustainable Development within the Engineering Curriculum [59] <i>Sloan Trad, Rosalie Goldsmith, Roger Hadgraft, Anne Gardner,</i> <i>U. of Technology Sydney, Australia</i>	517
Emotional Intelligence in engineering education: incorporating soft skills in the capstone chemical engineering design project [43] <i>Elena Tsalaporta, UCC, Ireland</i>	526
Sustainability, pandemia and women in academia: breaking the “good girl” culture to enhance sustainability in engineering education [101] <i>Elena Tsalaporta, Elizabeth Kyte, Maria Sousa Gallagher, UCC, Ireland</i>	534
A tool for introducing Social Life Cycle Assessment of products and feedback from its users [11] <i>Tatiana Vadimovna Vakhitova, Mike Ashby, ANSYS Granta, U. Cambridge., UK</i>	540
Teaching Sustainable Design through Simultaneous Evaluation of Economics and Environmental Impacts [49] <i>Kirti Yenkie, John Chea, Emmanuel Aboagye, Mariano Savelski and Stewart Slater,</i> <i>Rowan U., USA</i>	545

Sustainable Engineering Management for International Development: lessons learned from a new and interdisciplinary MSc programme [36]

553

Xiaojun Yin, Patricia Xavier, James Holness, Krijn Peters, Swansea U.,

EESD2021 Programme

Monday, June 14 2021

Monday June 14	Parallel Sessions 1	
11:10 - 12:30	Session 1a: Pedagogical Approaches I Chair: <i>John Fitzpatrick (University College Cork)</i>	Session 1b: Teaching Circular Economy & Greener Technology I Chair: <i>Javier Orozco-Messana (Universitat Politècnica de València)</i>
11:10 - 11:30	Sustainability Shares in the Classroom [33] <i>David Shallcross, U. Melbourne, Australia</i>	Teaching circular economy: Discussing limitations and opportunities of teaching about sustainable production [84] <i>Helen Kopnina, The Hague U. Applied Sciences, The Netherlands</i>
11:30 - 11:50	Challenge Driven Education for sustainability in engineering. A White Paper [94] <i>Gemma Tejedor [1], Anna-Karin Högfeldt [2], Jordi Segalas[1], Lena Gumaelius [2], [1] UPC-Barcelona, Spain [2] KTH, Sweden</i>	Circular Design project. Educating the Design Community in Sustainable Design [85] <i>Jordi Segalas[1], Adam de Eyto[2], Moireann McMahon[2], Yekta Bakirkioglu[2], Gemma Tejedor[1], Boris Lazzarini[1], Sine Celik[3], Alex Jimenez[4], Jonas Martins[5] [1] UPC-Barcelona, Spain, [2] U. Limerick, Ireland, [3] Stichting NHL, Netherlands, [4] Nut Creatives, Spain, [5] Ceci N'est Pas Une Holding B.V., Netherlands</i>
11:50 - 12:10	Using field trips in engineering education to facilitate the understanding of energy systems, technologies and transitions: an overview [81] <i>Lukas T. Gast, U. Cambridge, UK</i>	Connecting the Dots: Understanding Professional Development Needs of Istanbul's Makers for Circular Economy through Distributed Fabrication [72] <i>Yekta Bakırlioğlu [1,2], Maria-Laura Ester Ramirez Galleguillos [1], Ivon Bensason [1], Asım Evren Yantaç [1], Aykut Coşkun [1], Koç U., Turkey, Middle East Technical U., Turkey</i>
12:10 - 12:30	Walking the walk; meaningfully engaging people with engineering challenges [24] <i>Connor McGookin, Brian Ó Gallachóir, Edmond Byrne, UCC, Ireland</i>	Embedding Sustainability in Engineering Education through Interactive Industrial Design Case Studies [38] <i>Kevin Gibson, Jorge Oliveira, Denis Ring, UCC, Ireland</i>

Monday June 14	Parallel Sessions 2	
13:20 - 15:00	Session 2a: Architecture and Sustainability <i>Chair: Adam de Eyto (Limerick School of Art and Design, LIT)</i>	Session 2b: Global & Sustainability Competences <i>Chair: Karel Mulder (TU Delft)</i>
13:20 - 13:40	Re-Structuring Practice for Sustainability: Learning from Case Studies [91] <i>Stefani Danes, Carnegie Mellon U., Craig Stevenson, Auros, USA</i>	How do Graduate Civil Engineers Working in London Enact Global Responsibility and Support UN Sustainable Development Goals? [28] <i>Shannon Chance [1,2], Inês Direito [1], John Mitchell [1]. [1] UCL, UK, [2] TU Dublin, Ireland</i>
13:40 - 14:00	Application of CDIO Standard for teaching the Architectural Composition Subject with a practice competition about green architecture at Ho Chi Minh City University of Technology, Vietnam [37] <i>Hai-Yen Hoang, Ho Chi Minh City U. of Technology, Vietnam</i>	Sustainable Engineering Management for International Development: lessons learned from a new and interdisciplinary MSc programme [36] <i>Xiaojun Yin, Patricia Xavier, James Holness, Krijn Peters, Swansea U., UK</i>
14:00 - 14:20	Combining Sustainable Design Education with Research on Zero Energy Building Standards in Historic Buildings [104] <i>Kevin McCartney [1,2], Kevin Busby [1,3]. [1] Centre for Architectural Education, [2] UCC, [3] Munster Technological University, Ireland</i>	The Contemporary Engineer: Developing Sustainability Competences and Transferable Skills through Open-ended Activities [4] <i>John Fitzpatrick, Edmond Byrne, UCC, Ireland Francisco Javier Gutiérrez Ortiz, U. Seville, Spain</i>
14:20 - 14:40	Urban agriculture and its applications for office buildings in large urban areas in Vietnam [21] <i>Hai-Yen Hoang, Ho Chi Minh City U. of Technology, Vietnam</i>	A New Course on Sustainable Innovation and Entrepreneurship [22] <i>Pritpal Singh, Villanova U., USA</i>
14:40 - 15:00	Birr Community School – A Case Study in Retrofitting and Conserving Modern Architecture [105] <i>John McLaughlin, UCC, Ireland</i>	Education for Sustainability: Rethinking Digital Teaching and Learning Strategy [102] <i>Morag Munro, Maynooth U., Ireland</i>

Monday June 14	Parallel Sessions 3	
15:20 - 16:40	Session 3a: Pedagogical Approaches IV Chair: <i>Susan Nesbit (University of British Columbia)</i>	Session 3b: Pedagogical Approaches II Chair: <i>Brian Ó Gallachóir (University College Cork)</i>
15:20 - 15:40	Social and Ecological Responsibility within Engineering Education. A Modular Student-Driven Course Design that is Implemented at Seven German Universities [41] <i>André Baier, TU Berlin, Germany</i>	Perspectives on Challenge Driven Education for future Engineering education [107] <i>J. Hedvall, H. Lindberg, A. Rosén, Lena Gumaelius, KTH, Sweden</i>
15:40 - 16:00	Developing Inclusive and Sustainable Curriculum for Environmental Engineering Courses [47] <i>Kauser Jahan, Sarah Bauer, Jagadish Torlapati, Tiago Forin, Rowan U., USA</i>	Using an open course pack to support interdisciplinary learning in Sustainable Energy Engineering [100] <i>Kamaria Kuling, Taco Niet, Sheena Miao Ying Tan, Simon Fraser U., Canada</i>
16:00 - 16:20	Innovation Clubs: Mobilizing Local Creativity for Sustainable Development and Pedagogy [7] <i>Christianos Burlotos, Tracy Kijewski-Correa, Alexandros Taflanidis, William Cunningham. U. Notre Dame, USA</i>	‘Storying Architecture’ Pilot Study; Trial and Tribulation. Detailing the Methodology, Implementation, and Initial Findings of a Postponed Research Project in Bali, Indonesia. [80] <i>Alastair Brook, UCC, Ireland</i>
16:20 - 16:40	What works? Sustainability Grand Challenges in Engineering Curricula via Experiential Learning [23] <i>Amy Landis [1], Claire Dancz [2], Kristen Parrish [3], Melissa Bilec [4].</i> <i>[1] Colorado School of Mines, CO</i> <i>[2] Clemson University, SC, [3] Arizona St. U., AZ, [4] U. Pittsburgh, PA, USA</i>	Educating Engineers for the post-COVID 21st Century [106] <i>Paul Leahy [1], Dylan Furszyfer [2,3], Benjamin Sovacool [3], Aoife M. Foley [2].</i> <i>[1] UCC, R. Ireland, [2] QUB, N. Ireland, [3] SPRU, U. Sussex, UK</i>

Tuesday, June 15 2021

Tuesday June 15	Parallel Sessions 4	
10:00 - 11:00	Session 4a: Complexity & Uncertainty Chair: <i>Magdalena Svanström (Chalmers University of Technology)</i>	Session 4b: Embedding Sustainability in the Curriculum I Chair: <i>Marguerite Nyhan (University College Cork)</i>
10:00 - 10:20	Case studies in professional-oriented education: engaging with sustainability and complexity [48] <i>Kristen MacAskill, U. Cambridge, Catherine Tilley, King's College London, UK</i>	Challenging Practice Traditions to Embed Education for Sustainable Development within the Engineering Curriculum [59] <i>Sloan Trad, Rosalie Goldsmith, Roger Hadgraft, Anne Gardner, U. of Technology Sydney, Australia</i>
10:20 - 10:40	Challenging energy engineering undergraduates with diverse perspectives on nuclear power [42] <i>Fionn Rogan, Hannah Daly, Paul Deane, James Glynn, Paul Leahy, Edmond Byrne, UCC, Ireland</i>	Non-Discipline Specific Sustainability Knowledge & Competences in the Chemical Engineering Programme at UCC [2] <i>John Fitzpatrick, Edmond Byrne, UCC, Ireland</i>
10:40 - 11:00	Data Mining for Sustainability Analytics: An Educational Approach [70] <i>Mustafa Al Tekreeti, Salwa Beheiry, Ayman Alzaatreh, American U. Sharjah, UAE</i>	E-Mining@School; A Cross-Curricular Initiative To Embed Sustainability In The Junior Cycle Curriculum [31] <i>Lisa Kiely [1], Jude Sherry [2], Colin Fitzpatrick [2]. [1] Castletroy College, [2] U. Limerick, Ireland</i>

Tuesday June 15	Parallel Sessions 5	
13:20 - 14:40	Session 5a: Ethics & Social <i>Chair: Julie Clarke (University College Cork)</i>	Session 5b: Sustainability & Design <i>Chair: Denis Ring (University College Cork)</i>
13:20 - 13:40	Engineers as advocates for Sustainable Development: countering misinformation and the need for Aristotelian Rhetoric [9] <i>Richard Fenner, U. Cambridge, UK</i>	Towards a Sustainability-Centred Design Curriculum in Civil Engineering [20] <i>Thomas Froese [1], David Bristow [1], Keagan Rankin [2]. [1] U. Victoria, BC, [2] U. New Brunswick, Canada</i>
13:40 - 14:00	Integrating ethics across the curriculum through sustainability topics [17] <i>Diana Adela Martin [1,2], Eddie Conlon [1], Brian Bowe [1]. [1] TU Dublin, Ireland [2] TU Eindhoven, The Netherlands</i>	Identifying Students' Sustainability Preferences to Improve Design Team Performance [27] <i>Elise Barrella [1], Justyn Girdner [2], Robin Anderson [2], Mary Katherine Watson [3]. [1] Wake Forest U., NC, USA, [2] James Madison U., VA, USA, [3] The Citadel, SC,, USA</i>
14:00 - 14:20	A Novel Pedagogical Approach to Teaching Climate Change and Ethics [77] <i>Alandra Kahl, Penn State Greater Allegheny, USA</i>	Emotional Intelligence in engineering education: incorporating soft skills in the capstone chemical engineering design project [43] <i>Elena Tsalaporta, UCC, Ireland</i>
14:40 - 15:00	One Assignment, Two Courses, Multiple Skills: A Major Engineering Assignment with Social, Political and Ethical Dimensions [52] <i>Vivian Neal, Taco Niet, Simon Fraser U., Canada</i>	Approximating Professional Practice in a First-Year Engineering Curriculum: The Wind Turbine Maker Project [99] <i>Paul Leahy, Conor McGookin, Hannah Daly, UCC, Ireland</i>

Tuesday June 15	Parallel Sessions 6	
15:20 - 17:00	Session 6a: Teaching Circular Economy & Greener Technology II <i>Chair: Mariano Savelski (Rowan University)</i>	Session 6b: Social, Economic & Political Dimensions <i>Chair: Elena Tsalaporta (University College Cork)</i>
15:20 - 15:40	Closing the Circularity Gap Via Engineering Education for Circularity with a Whole Systems and Biomimetic Perspective [34] <i>Ross Lee, Karl Schmidt, Villanova U., USA</i>	Engineering Education for a Zero Growth Economy [5] <i>Gearold Johnson, Thomas Siller, Colorado St. U., USA</i>
15:40 - 16:00	Nature knows better? Nature as exemplar and/or inspiration? [65] <i>Laura Stevens [1], Karel Mulder [1,2], Helen Kopnina [2], Marc De Vries [1]. [1] Delft UT, [2] The Hague U. Applied Sciences, The Netherlands</i>	Eco-design, circular economy & social responsibility [89] <i>Valerie Massardier, Corinne Subai, INSA Lyon, France</i>
16:00 - 16:20	Industry 4.0 as an Enabler for Sustainable Manufacturing: - An Educational Perspective [15] <i>Caoimhe Coleman, Sara Abu Selmia, Ingrid Carla Reinhardt, Jorge Oliveira, Denis Ring, UCC, Ireland</i>	A tool for introducing Social Life Cycle Assessment of products and feedback from its users [11] <i>Tatiana Vadimovna Vakhitova, Mike Ashby, ANSYS Granta, U. Cambridge., UK</i>
16:20 - 16:40	Sustainable Approaches to the Management of Innovation and Technology in Engineering (SAMITE II) [61] <i>Iain Stalker [1], Rinkal Desai [2], Rachel Studd [3]. [1] U. Bolton, [2] U. Warwick, [3] The U. Manchester, UK</i>	Sustainability, pandemia and women in academia: breaking the “good girl” culture to enhance sustainability in engineering education [101] <i>Elena Tsalaporta, Elizabeth Kyte, Maria Sousa Gallagher, UCC, Ireland</i>
16:40 - 17:00	Designing Laboratory Experiments for Electricity Grid Integration of Renewable Energy using Microgrid, Test-Rig Emulators and Real Time Simulation Tools [44] <i>Donal Murray, Nuh Erdogan, Alparslan Zehir, Barry Hayes, UCC, Ireland</i>	

Wednesday, June 16 2021

Wednesday June 16	Parallel Sessions 7	
11:30 - 12:50	Session 7a: Pedagogical Approaches III <i>Chair: Jordi Segalas (Universitat Politècnica de Catalunya)</i>	Session 7b: Teaching Greener Tech III <i>Chair: Hannah Daly (University College Cork)</i>
11:30 - 11:50	Mind-mapping for Interdisciplinary Sustainable Architecture [3] <i>Javier Orozco-Messana, Universitat Politècnica de València, Spain</i>	Global Perspectives on Electric Vehicle Education: Part I [68] <i>John Hayes [1], Yue Cao [2], Xinmei Yang [3], Jessica Suda [4], Xiaofeng Yang [5], Jens Friebe [6], Osmar Ogashawara [7], John Renie [8], G.A. Goodarzi [9]. [1] UCC, Ireland, [2] Oregon St. U, OR, USA [3] Jilin U, China, [4] Southern Illinois U, IL, USA, [5] Beijing Jiaotong U, China, [6] Leibniz U., Germany, [7] U. Fed. de Sao Carlos, Brazil, [8] Indiana IT, IN, USA [9] US Hybrid Corp., CA, USA</i>
11:50 - 12:10	Crossing technical and non-technical skills: French case studies in engineering training [39] <i>Catherine Perpignan [1], Yacine Baouch [1], Vincent Robin [2], Benoit Eynard [1]. [1] U. Compiègne, [2] U. Bordeaux, France</i>	Global Perspectives on Electric Vehicle Education: Part II [69] <i>John Hayes [1], Yue Cao [2], Xinmei Yang [3], Jessica Suda [4], Xiaofeng Yang [5], Jens Friebe [6], Osmar Ogashawara [7], John Renie [8], G.A. Goodarzi [9]. [1] UCC, Ireland, [2] Oregon St. U, OR, USA [3] Jilin U, China, [4] Southern Illinois U, IL, USA, [5] Beijing Jiaotong U, China, [6] Leibniz U., Germany, [7] U. Fed. de Sao Carlos, Brazil, [8] Indiana IT, IN, USA [9] US Hybrid Corp., CA, USA</i>
12:10 - 12:30	Engineering Accreditation Objectives and their Relationship to the Quality Assurance Standards for Engineering Education Programmes in Ireland [90] <i>Maria Kyne, Limerick I.T., Ireland</i>	Engineering Mechanics and Sustainable Engineering [75] <i>Nand Jha, Manhattan College, USA</i>
12:30 - 12:50	A Proposal for Linking Origami Art in Robotics Engineering Education [12] <i>Guangbo Hao [1], Alex Pentek [2]. [1] UCC, Ireland, [2] National Sculpture Factory, Ireland</i>	Higher Education Approaches to Engender Students' Environmental Consciousness in Electronic Device Design [32] <i>Sivakumar Ramachandran, IADT, Ireland</i>

Wednesday June 16	Parallel Sessions 8	
14:00 - 15:40	Session 8a: Embedding Sustainability in the Curriculum II <i>Chair: Pritpal Singh (Villanova University)</i>	Session 8b: Transdisciplinary Education & Diversity <i>Chair: Gerard Mullally (University College Cork)</i>
14:00 - 14:20	How Cognitive Development Affects Student Perception by Threading Sustainability through Civil and Environmental Engineering Curriculum [62] <i>Jennifer Mueller, Rose-Hulman I.T., USA</i>	Exploring Transdisciplinary Education? [30] <i>Susan Nesbit [1], Naoko Ellis [1], Stefani Danes [2], Tanya Tan [1], Edmond Byrne [3], David Morgan [4], Javier Orozco-Messana [5].</i> <i>[1] UBC, Canada, [2] Carnegie Mellon U, PA, USA, [3] UCC, Ireland, [4] U. Cambridge, UK, [5] UP de Valencia, Spain</i>
14:20 - 14:40	A Sustainable Technologies Certificate Designed for Engineering and Engineering Technology Students (EESD2020) [8] <i>Patricia Fox, Charles McIntyre, Indiana U.-Purdue U. IN, USA</i>	Guidelines to improve Engineering Education for Sustainability through transdisciplinarity learning processes [93] <i>Gemma Tejedor, Jordi Segalas, UPC-Barcelona, Spain</i>
14:40 - 15:00	Strategic implementation of education for sustainable development within the industrial engineer curriculum [57] <i>Nuria Llaverias, Guillermo Reyes, U. Ramon Llull, Spain</i>	Excellence in education requires excellence in collaboration: learning modules in circular economy as platforms for transdisciplinary learning [53] <i>Niclas Sandström [1], Anne Nevgi [1], Thomas Betten [2]. [1] U. Helsinki, Finland, [2] Fraunhofer Inst. for Building Physics (IBP), Germany</i>
15:00 - 15:20	Embedding Sustainability across the Built Environment Curriculum and Beyond [88] <i>Mark Kelly, GMIT, Ireland</i>	Transdisciplinarity in a bio-engineering course [103] <i>Valerie Massardier, Sébastien Livi, INSA Lyon, France</i>
15.20 - 15.40	Teaching Sustainable Design through Simultaneous Evaluation of Economics and Environmental Impacts [49] <i>Kirti Yenkie, John Chea, Emmanuel Aboagye, Mariano Savelski and Stewart Slater, Rowan U., USA</i>	<i>National Forum for Teaching & Learning Research Spotlight:</i> Integrating the U.N. Sustainable Development Goals into a Connected Curriculum Framework at University College Cork <i>John Barimo, Catherine O'Mahony, Gerard Mullally, Edmond Byrne, John O'Halloran, Darren Reidy and Maria Kirrane, UCC, Ireland</i>

Data Mining for Sustainability Analysis: An Education Approach

Mustafa S. Al-Tekreeti¹, Salwa M. Beheiry² and Ayman Alzaatreh²

¹Doctoral Candidate, Engineering Systems Management PhD program, American University of Sharjah, UAE

b00049253@alumni.aus.edu

²Associate Professor of Civil Engineering at the American University of Sharjah, UAE

³Associate Professor of Mathematics and Statistics at the American University of Sharjah, UAE

Abstract

Our planet's population is increasing at a rapid pace and with it the demand for food and resources. Environmental Sustainability (ES), a part of Sustainable Development (SD) concepts and techniques, is key in mitigating the effects of resource overuse. Several indicators have been identified and used to develop ES measures such as an environmental performance index and an environmental vulnerability index. These indices are used to evaluate countries and provide support for decision-making regarding national mitigation strategies and climate risks. This paper describes an educational approach to raise ES awareness and improve SD analytical skills among doctoral level students in Engineering Systems Management. The data used in this paper is obtained from existing ES indices and available data. The students use data mining and analytics techniques to evaluate the data, find relationships, and draw conclusions. These techniques and conclusions are then shared in class presentations and conference publications. Data mining converts raw data into useful information that can be understood by different audiences. It can be used to persuade policymakers about the importance of sustainable strategies for a country, a society, or certain groups or individuals' welfare by highlighting meaningful patterns and trends in ES. The paper also aims to investigate possible correlations among environmental indices and their underlying indicators.

1 Introduction

The resources of planet earth are limited. Consuming the resources in an unsustainable way will deplete them. Major resource consumers are human activities. It is expected that the world's population will reach 9.7 billion by 2050 (Sarkodie et al., 2019). With the population increasing, the demand on resources will increase as well which will impose tremendous pressure on the earth's resources. Human activities cause another major problem: climate change. It affects human health through extreme weather resulting from increasing Greenhouse Gases (GHGs). In response to these threats, governments initiate national development strategies to manage their resources in an effective way and reduce GHGs emissions. The aim for those strategies is to enforce sustainability into society to conserve resources while maintaining living standards through Sustainable Development (SD) (Wang & Li, 2019). According to the World Commission on Environment and Development, SD "meets the needs of the present without compromising the ability of future generations to meet their own needs" (WCED, 1987, p43). Through SD, finite resources can be preserved such that future generations' needs are met.

This interpretation of SD is frequently associated with social and economic development, which should be part of Environmental Sustainability. Since the SD definition was first published and slowly become accepted, the concept of Environmental Sustainability (ES) emerged with it and has its own merits. To

evaluate a nation's ES, several indices and indicators have been developed, such as: environmental performance index, environmental vulnerability index, and ecological footprint, which all measure it. The aim of environmental sustainability is to maintain natural capital in a balanced condition, where both economic development and human consumption depend on the sustainable use of planet earth's resources. Without sustainability, the vitality of the freshwater system, oceans, land, and the atmosphere will be compromised and impact on human life in a negative way. The United Nations' millennium development goals emphasize global collaboration as essential to ensure that environmental sustainability is applied in order to maintaining biodiversity and to minimize the losses of essential global natural resources (Olafsson et al., 2014). An example of these resources is the planet's forests, which not only provide inputs for national economic processes but also play an essential role in mitigating anthropogenic climate change through carbon sequestration (Stewart, 2003).

Sustainability indices provide raw data for each country about their performance in conserving resources, reducing GHGs emissions, and renewable energy uses. On other hand, the environmental performance index gives data relating to air pollution and child mortality (Olafsson et al., 2014). However, these data need to be processed to make a meaningful interpretation of the sustainability situation and support the necessary policies that promote environmental conservation. One way to process raw data is data mining. Data mining is the process of identifying essential knowledge about and relationships between data variables to draw patterns and useful information about the data (Di Blas, 2015).

The source of the data used in this paper is the United Nations Development Programme (UNDP) website. This website is open-source and provides data related to humanity and its welfare. The data combines different environmental sustainability indices for several countries, and is part of Human Development Reports published by UNDP. This report measures the key dimensions of human development in health, decent living standards and knowledge (OCHA, 2016). The aim of this paper is to find the possible relationships between different ES variables and environmental threats to human welfare (mortality rate due to air pollution and unsafe water) as an education approach, to identify the hidden factors and correlations that control them through data mining in order to facilitate the interpretations for the data to policy makers and scholars interested in environmental sustainability.

2 Literature Review

2.1 Environmental Sustainability and its Indices

The term ES was first conceptualized by researchers at the World Bank. Subsequently, it changed to environmentally sustainable development (Serageldin and Streeter, 1993). The final concept was developed by Goodland to be environmental sustainability. ES is a concept entwined with SD through focusing on the social and economic development of a country. ES defined as "improve human welfare by protecting the sources of raw materials used for human needs and ensuring that the sinks for human waste are not exceeded, in order to prevent harm to humans" (Goodland, 1995, p. 3). Goodland identifies ES concepts as a set of four constraints on major activities that control the human economic system, which are: on the source side the non-renewable and renewable resources use, and waste assimilation and pollution on the sink side (Goodland, 1995). In contrast, Holdren et al. (1995) defined ES as a concept that focuses on bio-geophysical aspects, where the meaning of biophysical sustainability is to improve or maintain the integrity of earth's

life-supporting systems through conservation which means the proper use of water, air, and land resources while improving the social and economic aspects of the current and future generations.

After defining the concept of ES by a number of scholars, several indicators emerged to measure it. Several studies have proposed different methods to measure ES and how to construct its indicators using qualitative and quantitative techniques (Cano-Orellana & Delgado-Cabeza, 2015). Those indicators focus on the current sustainability status for a country using reference values or trends generated based on historical conditions (Milman & Short, 2008). Examples for those indicators are: Environmental Vulnerability Index (EVI), Environmental Performance Index (EPI), and Ecological Footprint (EF)

2.2 Data Mining

Data mining, according to Han et al. (2001), is “the process of discovering interesting knowledge, such as patterns, associations, changes, anomalies and significant structures, from large amounts of data, stored in large databases, data warehouses or other information repositories” (Han et al., 2011, p.1). Analyzing the data through statistical software will help to find possible correlations among raw data as well as distinctive patterns between data variables (Wu et al., 2013). Grossman et al. (2013) stated that data mining involves: handling large amounts of quantitative data, discovering patterns, not needing a hypothesis (as results are driven by data). Major tasks regarding data mining can be listed as follow: class description (summary of collection data), data association (finding correlations within data sets), prediction (finding possible future values), clustering (grouping similar data), etc. Data mining uses data to extract useful information and transform it into understandable and structured information for future use. It helps business stakeholders to understand the meaning of complex data from their company and overcome any challenges to ease the interpretation of the data’s information (Grossman et al., 2013).

3 Methodology

This paper provides quantitative research analysis using data from the UNDP report in order to find possible relationships between several ES variables and environmental threat variables which are considered the aim of this paper. Different statistical tools are used to analyze the data and investigate the hidden correlations among the variables. Those analyses are used as learning techniques to show how to investigate datasets and conclude useful information from them. This research tries to answer the following question:

- Are there any relationships between the mortality rate due to air pollution, unsafe water and the ES variables?

3.1 Data Description

The data used for the analysis in this paper comes from the UNDP report which is open-source. The data combines different ES indices from different databases such as: World Bank, Human Development Report Office (HDRO), Food and Agriculture Organization (FAO), and World Health Organization (WHO) for 189 countries and regions. The data is divided into two groups: ES indices and environmental threats to human welfare that form 10 indicators. Based on the country’s human development level, the data is categorized into four groups: very high human development (58 countries and regions), high human development (52 countries and regions), medium human development (38 countries and regions), and low human development (37 countries and regions).

ES 7 indicators are described and measured as follows. Fossil fuel energy consumption: calculate the percentage of total consumption of energy that comes from using fossil fuels (e.g. oil, coal, natural gas, and petroleum); renewable energy consumption: calculate the percentage share of renewable energy (such as solar, wind, hydroelectric, and geothermal) in the final total energy consumption; carbon dioxide emissions: the carbon emission generated from human activities such as burning fossil fuels, cement production and gas flaring as well as the carbon emissions from forest degradation. The data in this index is expressed in two ways: tones per capita, and in kilograms per Purchasing Parity Power (PPP) of GDP in US dollars. The forest area index is expressed in two ways: the percentage of total land covered by trees natural or planted that stand for more than 5 meters and excludes the land covered by trees in agriculture and urban use (parks and gardens), and the percentage change of this forest area in the period from 1990 to 2015. Fresh water withdrawals: the percentage of freshwater withdrawals (freshwater taken from surface or ground water sources) of total renewable water resources. The withdrawals include irrigation, industrial use, and domestic use, etc. (UNDP, 2018).

The indices for environmental threats to human welfare are: mortality rate attributed to indoor and outdoor air pollution expressed per 100,000 population, mortality rate attributed to using unsafe water or sanitation and hygiene services expressed per 100,000 population, and red list index: the value that measures the aggregate risk extinction across a species group. It shows the trend in overall species that are at risk of extinction through tracking the changes in species number in each category that is in extinction risk. The value of this index ranges from 0 (all categorized species are extinct) to 1 where all categorized species are of least concern (low risk of extinction). This index helps the government to track their progress in reducing the loss in biodiversity (UNDP, 2018). Table 1 shows a summary of the data variables used in this study.

Table 1: Summary of Data Variables

Environmental Sustainability (ES) Indices	Environmental Threats to Human Welfare
Fossil Fuel Energy Consumption	Mortality Rate Attributed to Indoor and Outdoor Air Pollution
Renewable Energy Consumption	Mortality Rate Attributed to Using Unsafe Water
Carbon Dioxide Emissions: Tones Per Capita, and in kilograms Per Purchasing Parity Power (PPP) of GDP	Red List Index
Forest Area: Total Land Covered and Forest Area Percentage Change	
Fresh Water Withdrawals	

4 Data Analysis and Discussion

As mentioned in the literature review, the main tasks for data mining are: data description, data association, clustering, and prediction. Those tasks will be followed in this data analysis to investigate the dataset as a learning approach. The data is analyzed using Statistical Analysis System (SAS) software. This software can perform different statistical analysis varying from simple statistics to multivariate analysis. Since the

focus of this research is on data mining, the following analysis will be used: simple graphs (scatter plot) between both mortality rate due to air pollution and unsafe water and the other variables, cluster analysis to show how the ES variables are grouped, conducting Factor Analysis (FA) to highlight the latent variables that affect specific group of ES variables, performing Pearson and canonical correlation between mortality rate due to air pollution and unsafe water as one set and the other ES variables as another set, and conduct multivariable regression. Due to the large amount of incomplete data in medium and low human development countries that causes inaccuracy in the analysis, the analysis will focus on the first two groups: very high and high human development countries. As stated in the methodology, this analysis is used as an educational approach to highlight how to use data mining techniques to structure useful information that can be easy to interpret. Each analysis tool/technique will reveal specific items of information and/or confirm the finding of the previous ones.

4.1 Data Association

One of the tasks in data mining is to find the possible associations between the variables. There are several ways to investigate the possible patterns among the data variables, such as using graphs that underlie the possible patterns between variables (scatter plots). Figure 1 shows the possible relationships between mortality rate (air pollution and unsafe water) and other ES variables. Increasing the energy consumption of fossil fuel will increase the mortality rate due to air pollution due to the increase in hazed gas emissions for burning fossil fuels which lead to serious illnesses of the human respiration system, because the emissions that are related to fossil fuel burning will lead to serious illnesses of the human respiratory system. Particulate matter (PM10/2.5) is also a fossil fuel triggered problem that causes health issues. It is airborne and varies in size and chemical and physical composition (Zhao et al., 2013). The size of those particles is small enough to penetrate the human lungs and lead to severe health risks. Another gas emitted from burning fossil fuels and affects human health is Nitrogen oxides (NO_x). It is inorganic gases formed by the amalgamation of oxygen with nitrogen available in the air, which causes destructive effects to the human bronchial system (Zhao et al., 2018). Since scatter plots do not show all possible patterns among the variables, another analysis can be used to find this. Pearson correlation is an analysis tool that measures the linear correlation between two variables to investigate the possible relationship between them (Benesty et al., 2009). The importance of Pearson correlation for the data will be indicated through the p-value. If the p-value of the correlation is less than $\alpha = 0.05$, then the correlation is significant, otherwise it is not.

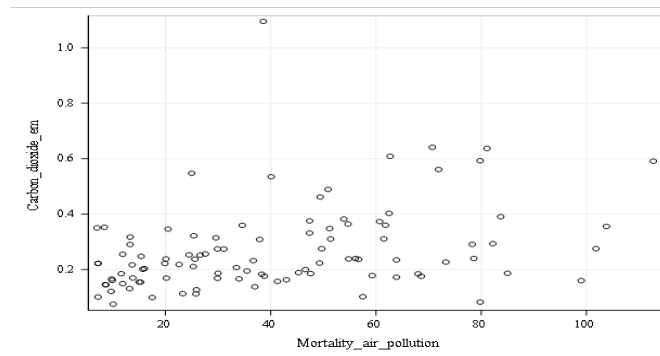

Figure 1: Scatter Plot between Mortality Rate (Air Pollution) and Carbon Dioxide Emission Kg per PPP of GDP

The correlation results shown that fossil fuel energy consumption, carbon dioxide emission Kg per PPP of GDP, and freshwater withdrawals significantly correlate to mortality rate due to air pollution. Increasing the freshwater withdrawals will lead to a decrease of the flora that cover the land due to low precipitation and decrease of the groundwater level that leads to increased desertification which causes major threats to human health due to dust and other pollutant particles. In addition, lowering the flora cover will limit the role of trees in capturing carbon dioxide from the air which by extension will cause health issues to humans. On the other hand, the mortality rate due to unsafe water is correlated negatively with the red index. This indicates that decreasing the species that have a risk of extinction will increase the mortality rate due to unsafe water. This is because more diverse animal species living near or in the water sources will lead to the transfer of infections from those animals due to their feces and/or corpses and this will increase the mortality rate due to unsafe water.

A different method in correlation is called Factor Analysis (FA). It describes the correlation among variables in terms of a potential latent (unobserved) variable called a factor. It is a way to show hidden patterns between the variables (Costello & Osborne, 2005). Figure 2 shows the path diagram for the FA. The first factor can be called the energy factor, since it is correlated to the following variables: fossil fuel energy consumption, carbon dioxide emission Kg per PPP of GDP (both positively correlated to energy factor), and renewable energy consumption (negatively correlated to energy factor). The second factor can be called the forest area factor. Because both forest area (negatively correlated to forest factor) and changes in forest area (positively correlated to forest factor) variables are correlated to it. Factor three is called the red index factor, since it positively correlates with only one variable which is the red index.

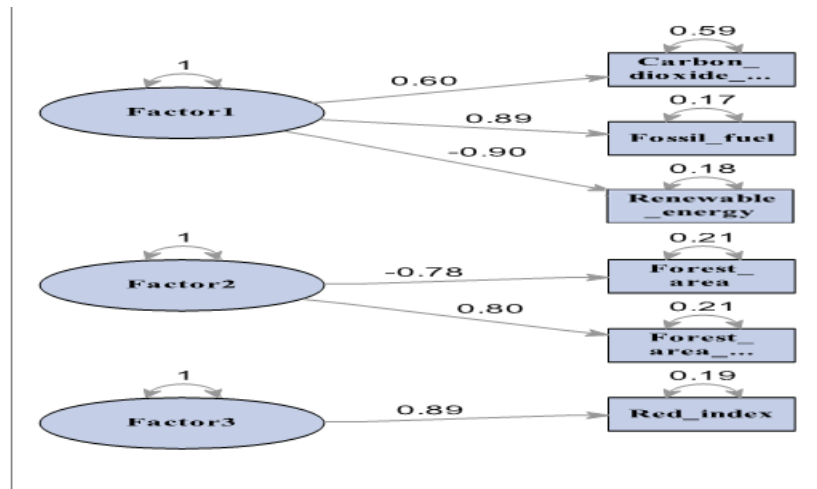

Figure 2: Factor Analysis Path Diagram

4.2 Data Clustering

Another task in data mining is represented by clustering. It divides the variables into groups based on its similarity (Xu & Wunsch, 2008). Clustering will help to understand how the variables are grouped to identify the common characteristics among them. Figure 3 show how the variables are clustered. It can be seen that the variables are grouped into three distinct clusters. Forest area and change in forest area variables are grouped in one cluster. Freshwater withdrawals, carbon dioxide emission per capita and Kg per PPP of

GDP variables are clustered in one group. Energy consumption from fossil fuel sources, renewable sources and red index variables are grouped into one cluster.

4.3 Data Prediction

The final task in data mining is prediction. Since there are two dependent variables the best technique is, therefore, multivariate regression. It predicts the behavior of several dependent variables associated to changes in independent variables (Imai, 2011). The two dependent variables in this analysis are mortality rate due to air pollution and unsafe water, and the other variables are treated as independent variables. The fitness of multivariate regression model indicated by R-squared which is 0.7854. This model shows that the only significant predictors (which p-value less than $\alpha=0.05$) for the mortality rate due to air pollution are fossil fuel energy consumption, carbon dioxide emission Kg per PPP of GDP and freshwater withdrawals. The fitness of this model indicated by R-squared which is 0.7854. The prediction equation for the mortality rate air pollution will be as follows:

$$\begin{aligned}
 \text{Mortality Air Pollution} & \quad (1) \\
 & = -37.19696 + 0.41461 (\text{fossil fuel energy consumption}) \\
 & - 142.45164 (\text{carbon dioxide emission Kg per PPP of GDP}) \\
 & + 0.05134 (\text{freshwater withdrawals}),
 \end{aligned}$$

On the other hand, two variables are significant predictors of mortality rate due to unsafe water: forest area and red index variables. The fitness of this model indicated by R-squared which is 0.7567. Then the prediction equation for the mortality rate unsafe water will be:

$$\text{Mortality Unsafe Water} = 0.92020 + 0.01031(\text{forest area}) - 1.62837(\text{red index}), \quad (2)$$

Therefore, using the above equations can help to predict future changes for mortality rate whether form air pollution or unsafe water.

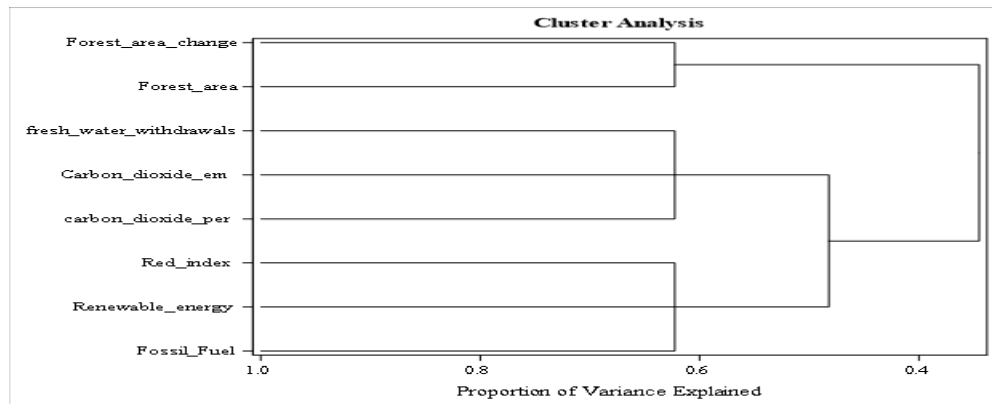

Figure 3: Cluster of Data Variables

5 Conclusion

Data mining is considered a powerful tool to analyze the data and understand the possible patterns among the variables. From analyzing the data for this paper, several important items of information have been revealed. There is a positive relationship between mortality rate due to air pollution and fossil fuel energy consumption, carbon dioxide emission per capita and Kg per PPP of GDP, and freshwater withdrawal variables. In addition, forest area and renewable energy consumption correlate negatively to the mortality rate due to air pollution. On the other hand, mortality rate due to unsafe water is negatively correlated with the red index variable. From cluster analysis, variables are clustered into three groups based on similarity. Forest area and change in forest area is the first group; freshwater withdrawals, carbon dioxide emission per capita and Kg per PPP of GDP is the second group; and consumption of energy from renewable sources and fossil fuel sources and red index is the third group. This indicates that there is a common relationship between them which could be investigated in detail in the future. The predictors for mortality rate air pollution from multi-variant regression analysis are: fossil fuel energy consumption, carbon dioxide emission Kg per PPP of GDP and freshwater withdrawals. However, the predictors for mortality unsafe water are forest area and red index variables. Those items of information can guide future research among environmental scholars to investigate in detail the cause of those relationships and what are the reasons behind those findings.

Moreover, the use of data analytics as a progressive and open-minded pedagogical tool has great potential in transforming engineering education at both the graduate and undergraduate levels. In this particular study, the data was carefully examined, and connections and correlations found. From this connection, conclusions were drawn, and new analysis triggered and explored. This work was conducted in partial fulfillment of a doctoral-level course in sustainability analytics, aiming to teach students the use of data mining and analytics to explore sustainable development issues, and how to find answers to theses from data and scholarly work.

References

- Benesty, J., Chen, J., Huang, Y., & Cohen, I. (2009). Pearson correlation coefficient. In *Noise reduction in speech processing* (pp. 1-4). Springer, Berlin, Heidelberg.
- Cano-Orellana, A., & Delgado-Cabeza, M. (2015). Local ecological footprint using Principal Component Analysis: A case study of localities in Andalusia (Spain). *Ecological Indicators*, 57, 573-579.
- Costello, A. B., & Osborne, J. (2005). Best practices in exploratory factor analysis: Four recommendations for getting the most from your analysis. *Practical assessment, research, and evaluation*, 10(1), 7.
- Di Blas, N. (2015). Exploratory portals of research data in education. *Research on Education and Media*, 7(2), 21-27.
- Goodland, R. (1995). The concept of environmental sustainability. *Annual review of ecology and systematics*, 26(1), 1-24.
- Grossman, R. L., Kamath, C., Kegelmeyer, P., Kumar, V., & Namburu, R. (Eds.). (2013). *Data mining for scientific and engineering applications* (Vol. 2). Springer Science & Business Media.

- Han, J., Kamber, M., Pei, J. (2011). *Data Mining: Concepts and Techniques*. In *The Morgan Kaufmann Series in Data Management Systems*, Morgan Kaufmann Publishers.
- Holdren, J. P., Daily, G. C., & Ehrlich, P. R. (1995). The meaning of sustainability: biogeophysical aspects. *Defining and measuring sustainability: the biogeophysical foundations*, 3-17.
- Imai, K. (2011). Multivariate regression analysis for the item count technique. *Journal of the American Statistical Association*, 106(494), 407-416.
- Milman, A., & Short, A. (2008). Incorporating resilience into sustainability indicators: An example for the urban water sector. *Global Environmental Change*, 18(4), 758-767.
- OCHA. (2016). *UNDP Human Development Reports Office (HDRO)*. Retrieved from <https://data.humdata.org/organization/undp-human-development-reports-office>.
- Olafsson, S., Cook, D., Davidsdottir, B., & Johannsdottir, L. (2014). Measuring countries' environmental sustainability performance—A review and case study of Iceland. *Renewable and Sustainable Energy Reviews*, 39, 934-948.
- Sarkodie, S. A., Strezov, V., Weldekidan, H., Asamoah, E. F., Owusu, P. A., & Doyi, I. N. Y. (2019). Environmental sustainability assessment using dynamic Autoregressive-Distributed Lag simulations—Nexus between greenhouse gas emissions, biomass energy, food and economic growth. *Science of the Total Environment*, 668, 318-332.
- Serageldin, I., Streeter, A. (1993). *Valuing the environment: proceedings of the First Annual Conference on Environmentally Sustainable Development*. Environmentally Sustainable Development Proceedings Series No. 2, The World Bank, Washington, D.C.
- Stewart, K. (2003). Selling forest environmental services. *Economic Botany*, 57(4), 659-659.
- United Nations Development Programme. (2018). *Human Development Reports*. Retrieved November 29, 2019, from <http://hdr.undp.org/en/content/dashboard-4-environmental-sustainability-0>.
- Wang, Z. X., & Li, Q. (2019). Modelling the nonlinear relationship between CO2 emissions and economic growth using a PSO algorithm-based grey Verhulst model. *Journal of cleaner production*, 207, 214-224.
- World Commission on Environment and Development. (1987). *Our common future* (Oxford paperbacks). Oxford: Oxford University Press.
- Wu, X., Zhu, X., Wu, G. Q., & Ding, W. (2013). Data mining with big data. *IEEE transactions on knowledge and data engineering*, 26(1), 97-107.
- Xu, R., & Wunsch, D. (2008). *Clustering* (Vol. 10). John Wiley & Sons.
- Zhao, B., Wang, S., Wang, J., Fu, J., Liu, T., Xu, J., . . . Hao, J. (2013). Impact of national nox and so2 control policies on particulate matter pollution in china. *Atmospheric Environment*, 77, 453-463.

Zhao, S., Liu, S., Hou, X., Cheng, F., Wu, X., Dong, S., & Beazley, R. (2018). Temporal dynamics of so₂ and nox pollution and contributions of driving forces in urban areas in china. *Environmental Pollution* (barking, Essex : 1987), 242, 239-248.

Social and Ecological Responsibility within Engineering Education. A Modular Student-Driven Course Design that is Implemented at Seven German Universities.

Dr.-Ing. André Baier¹

¹Institute of Machinery Systems and Systems Technology, Technische Universität Berlin, Germany

andre.baier@tu-berlin.de

Abstract

The Blue Engineering Course is a student-initiated course design that addresses the social and ecological responsibility of engineering. Its student-driven character is achieved through a set of over 150 building blocks, these are well-documented teaching/learning units which are freely available online. The course consists of three parts so that the students gradually acquire the competences to co-conduct and co-develop the course: 1) Students get to know high quality building blocks conducted by a lecturer/student tutors; 2) Students conduct existing building blocks; 3) Students develop new building blocks, conduct them and document them for future use.

The design of the Blue Engineering Course has been implemented at Technische Universität Berlin since 2011. Here, over 100 students participated in 18 consecutive semesters. The course design is also successfully adapted and implemented at six other universities in Germany. In total, four exemplary implementations are presented and then analyzed with regard to the transferability and success factors of its implementation.

1 Educational Design of the Blue Engineering Course

1.1 Genesis of the Blue Engineering Course

The student initiative Blue Engineering - Engineers with Social and Ecological Responsibility, commonly shortened to Blue Engineering was the starting point for the design and conduction of a student-driven course at Technische Universität Berlin. A group of students clearly saw the need for a course that covers the social and ecological responsibility of engineers (Baier 2012). However, in 2009 the university was not offering any particular course on this topic, thus they decided to create a course on their own. So, they set off to design a course that they would like to attend themselves. Since engineering education is dominated by ex-cathedra lectures and summative assessments at the end of a semester, they disregarded any teacher-centered form of education. Instead, they opted for a student-centered approach, so that engineering students actively engage in unveiling the complex interdependencies of their social, political, ecological and economic surroundings. It is important that the participants themselves do this analysis so

that they start to grasp their personal responsibility as well as the collective responsibility of engineers (Baier and Pongratz 2013). This also requires that the participants would learn to consider the different values, interests and needs from a global perspective as well as within one class(room) (Pongratz and Baier 2015). The student group further called for a course design which encourages democratic decision-making and the corresponding action to not only solve, but also to define problems within the course itself as well as outside of the classroom. By designing the Blue Engineering Course in such a way, it has become not only a student-driven course with respect to its genesis (Baier 2013), but also in regard to its implementation as the participants acquire valuable competences to co-create their environment.

1.2 Building Blocks - Well-Documented Teaching/Learning Units

Key element of this student-driven design is the concept of building blocks, that is 15 to 90 minute long teaching/learning units. Each building block must provide an appropriate set of methods to enable any generally interested group with a maximum of 25 persons to acquire a certain insight into the ecological and social dimensions of technology. In order to reach this goal, building blocks are self-contained teaching/learning units that cover one specific topic and that provide different methods that engage the participants in co-conducting a lesson more or less by themselves. Therefore, the person conducting the building block does not function as an expert that simply conveys knowledge but as a facilitator that organizes a complex group process.

The over 150 existing building blocks cover a broad range of topics within the field of social and ecological engineering. Some of these building blocks help to thoroughly analyze single technologies, e.g. fracking, preimplantation diagnostics, while others address the general effects of technology on society or nature. There are a number of building blocks which address the individual sphere, e.g. food and living preferences, while other building blocks address the global sphere, e.g. agricultural industry, capitalism, climate change. Several building blocks particularly address the work-life of engineers and the concept of work in general.

Along with the wide variety of topics, every single building block uses a specific set of teaching formats such as case studies, storytelling and station learning. Most building blocks, however, rely on a specific adaptation and new combination of known methods, e.g. learning cascades, court trials and educational games.

Building blocks generally consist of a well-documented, easy-to-use manual that provides all relevant information about the specific content, respective sources, external partners and clear methodological instructions along with a timetable. They provide clear instructions to facilitate the respective building block as well as compact background information, that consider multiple perspectives. All existing building blocks are published under a Creative Commons License (2009), which allows the use of these building blocks if the derived work is licensed with the same license and if attribution is given. The building blocks are publicly available on the Blue Engineering website (2018). Most of the building blocks are in German, however an initiative has been taken to translate a core set into English.

Typically one or two building blocks are conducted in each lesson of the Blue Engineering Course. The following two sections present the course design and its implementation in order to provide an overview how building blocks are used in the course.

1.3 Course Design of the Blue Engineering Course

Generally speaking, the Blue Engineering Course can be divided into three parts. This division ensures a step by step process where the students gradually take over more and more responsibility in conducting their course and in developing the Blue Engineering Course for future generations of students.

The first part of the Blue Engineering Course consists of a fixed set of core building blocks that are conducted every semester. This first part of the course is entirely conducted by the lecturer/student tutors and covers four to six building blocks. The basic idea of this phase is to let the students familiarize themselves with the educational concept as they most likely have not yet participated in a similar course during their education. Consequently, the first weeks of the course are mostly about giving them the space to get to know each other as well as to explore the different opinions and values present in the group. This is done in order to unveil different perspectives on various topics and to help the participants to value these perspectives as an asset in order to take proper action as an individual and within a group.

In the second part of the Blue Engineering Course, the participants are supposed to keep this general setup once they take over by conducting existing building blocks and preparing their semester projects. Here, groups of three to six students conduct an existing building block to about 20 to 25 fellow students. By doing this, the students experience first hand how it is to conduct a demanding teaching/learning unit on a specific topic that makes use of a broad set of methods in order to create a meaningful learning environment. Here, they gain the competence to conduct a demanding and complex teaching/learning unit for others.

The third part of the Blue Engineering Course builds upon the first two parts. Parallel to the first two parts of the course, the students use their experiences in order to create new building blocks that they will conduct and document during the third and last part of the Blue Engineering Course. Here, the students gain the competences necessary to develop a demanding building block on their own and conduct it to their fellow students. This building block is then documented so that others may use it in the future.

1.4 Assessment of the Students

For a successful completion, the students have to fulfil three assignments: 1) keeping of a learning journal; 2) conduction of an existing building block to their fellow students; 3) the semester projects consists of the conduction and documentation of a new building block.

The learning journal and the conduction of an existing building block each make up 25 % of the final grade and are each assessed through five criteria. The semester project makes up the other 50 % of the final grade and are assessed through ten assessment criteria.

The conduction of an existing building block and the semester project set a strong focus on collective action as they are done by small groups of three to six students. The keeping of a learning journal throughout the whole course is the only individual assessment that takes place and for that, every student is responsible for him_herself.

2 Implementation and Evaluation of the Blue Engineering Course at Technische Universität Berlin

2.1 Overview of the Course Setup at Technische Universität Berlin

The Blue Engineering Course at Technische Universität Berlin is offered by the Chair of Machinery Systems Design. Responsible for the course is the head of chair Prof. Dr.-Ing. Henning Meyer. The course is coordinated by a person holding one half lecturer position who mostly coaches and supervises the student tutors. The course itself is conducted by three student tutors with a total of 120 monthly hours.

The *Blue Engineering* Course has a capacity of 75 students in total. The students are typically split up into three rooms, so that there is a maximum of 25 students in each room and one assigned responsible student tutor. The lessons 1, 3, 7, 10 and 14 are (partially) conducted with all 75 students in one room by all three student tutors together.

The course is credited with 6 ECTS points and a total of four course hours per week. A semester typically spans 14 weeks.

The *Blue Engineering* Course started as a compulsory elective course in three master study programs: Mechanical Engineering, Industrial Engineering and Computational Engineering Science. As of winter semester 2017/2018 the *Blue Engineering* Course is established as a compulsory elective in the bachelor programs of Mechanical Engineering, Industrial Engineering, Computational Engineering Science, Transport Systems Engineering, Sustainable Management and a STEM Orientation Study Program. Every other student may take this course as an elective in order to receive credit points or participate without a final assessment.

2.2 Course Plan of the Blue Engineering Course at Technische Universität Berlin

The following Table 1 gives an exemplary course plan for the Blue Engineering Course. The three parts of the course, discussed in the previous section, are highlighted.

Table 1: Exemplary Course Plan of the Blue Engineering Course

Week/ Lesson	Room - A	Room - B	Room - C
<i>Conducted by Tutors</i>			
1	Introduction all in room A		
2	Plastics - common start for all in room A including knowledge chest Plastics - Role Play		

3	Topic- and Group Finding as well as TINS-D Constellation all in room A		
4	Technology as Problem-Solver!?	Responsibility and Ethical Codes	The Productivist Worldview
5	The Productivist Worldview	Technology as Problem-Solver!?	Responsibility and Ethical Codes
6	Responsibility and Ethical Codes	The Productivist Worldview	Technology as Problem-Solver!?
<i>Building Blocks Conducted Solely by Students and Created by former Students</i>			
7	Work, Society and Labour Unions all in room A including external expert		
8	Global Village 25 Questions by Frisch	Automation vs. Good Jobs CO2 Usage	Climate Trial Phoneblocks
9	Microplastics Peak Everything	Democratization of Work Greenwashing	Blue Stories Prisoner's Dilemma
10	Gender, Diversity and Technology common start for all in room A including external expert		
	Anti-Discrimination Exercise	Anti-Discrimination Exercise	Anti-Discrimination Exercise
<i>Newly Building Block Created and Conducted Solely by Students</i>			
11	2 Student's Building Blocks	2 Student's Building Blocks	2 Student's Building Blocks
12	2 Student's Building Blocks	2 Student's Building Blocks	2 Student's Building Blocks
13	2 Student's Building Blocks	2 Student's Building Blocks	2 Student's Building Blocks
14	Final Lesson with Market of all Newly Created Building Blocks in Room A		

2.3 Evaluation of the Blue Engineering Course at Technische Universität Berlin

The descriptive statistical analysis of the participants of the Blue Engineering Course shows that the number of participants has continually risen (Baier 2018). In total, 831 students passed the exam across the 14 semesters from winter semester 2011/2012 until summer semester 2018. The course attracted

students from a broad range of study programs which generated an interdisciplinary working atmosphere. Roughly one quarter of the participants studied mechanical engineering and roughly one quarter studied industrial engineering. The remaining half of the students had a background in 44 different study programs. About 55 % of the students were enrolled in a master's program and roughly 40 % were enrolled in a bachelor's program.

A qualitative evaluation (Baier 2018) shows that each of the 12 learning outcomes on module level is addressed through a broad range of learning activities and learning assessments. Accordingly, the students are required to use the 12 sub-competences of Gestaltungskompetenz (Haan 2006; 2010) not only at one single instant during the course but they are required to demonstrate the use of these 12 sub-competences in many instances. This finding is further underlined through a comprehensive quantitative evaluation (Baier 2017; 2018) which covered five semesters in total. It consisted of a triangulation for three selected core building blocks and a comparative self-assessment of the student's perceived competences.

3 Exemplary Implementation at Three Other Universities in Germany

The concept of the Blue Engineering Course is taken up at six other universities in Germany: TU Dresden, TU Hamburg, HTW Berlin, TH Köln, HS Düsseldorf and HS Ruhrwest. Three exemplary implementation will be presented here. In two cases, students took the initiative to establish their own local adaptation of the Blue Engineering Course at their university.

3.1 Technische Universität Hamburg

The Blue Engineering Course at Technische Universität Hamburg-Harburg runs continuously since winter semester 2012/2013. There it is offered as a 2 point ECTS block course in the free elective area for all study programs. Bachelor students attend a block course on two weekends, while master students start with a kick-off event and conduct themselves a series of evening events. The two courses are conducted entirely by student tutors. Formally responsible for the course is a former member of the student group who initiated the course. She is now working as a lecturer.

3.2 Hochschule Düsseldorf

Since 2016, a Blue Engineering Course has been offered at Hochschule Düsseldorf as a 5 point ECTS course in the compulsory elective area of several bachelor study programs. The course takes place every week in the first half of a semester and concludes with a weekend block in the middle of the semester. A local professor initiated the course by inviting the course's lecturer of Technische Universität Berlin as visiting lecturer. In one six day block Blue Engineering Course the participants gained the competence to conduct the course on their own in the future. Three participants then served as student tutors for the following courses (Kramer et al. 2019).

3.3 Hochschule für Technik und Wirtschaft Berlin

Starting in winter semester 2018/2019, the Blue Engineering Course is offered in the "general scientific area" that is included in all study programs at Hochschule für Technik und Wirtschaft Berlin. The course is credited as a 5 point ECTS course. The course is conducted every other week for four hours across the

whole semester. The course is run by a student tutor of the course at Technische Universität Berlin in the position of a visiting lecturer. The objective of the course is to empower the students to offer their own Blue Engineering Course next semester.

4 Analysis of the Implementation of the Blue Engineering Course Design

4.1 Transferability to Other Contexts

The adaptation and implementation of the course to a curriculum of one's own university is usually not a problem, as the modular concept of the course allows it to be adapted easily. All in all, the four different implementations in total show that the design can be flexibly adapted to the respective conditions of a university and that its implementation might lead to a continuous incorporation of social and ecological responsibility within the engineering education. The various people involved in the Blue Engineering Courses also conducted numerous one day to six day workshops at other universities, such as TU Delft, Aalborg University and Sharif University of Technology Tehran. In addition, the building blocks are highly flexible and may be used in any educational setting where the role of technology within society needs to be addressed in an interactive manner.

4.2 Success factors and Challenges Encountered

The most important prerequisite for the establishment of the Blue Engineering Course are committed students who not only initially designed the course, but who later on took the responsibility as student tutors to conduct the course themselves. Over the course of 14 semesters, several generations of student tutors passed on their expert knowledge of conducting the course. The demanding work as a tutor, offering a complex, interactive course independently, also allows the tutor to acquire skills that would otherwise hardly be taught during their studies.

The implementation at another university may follow the example of Hochschule Düsseldorf. Here, the future tutors first participated in a Blue Engineering Course offered at their university and three of them wanted to offer the course themselves in the next semesters. In the first semesters of the implementation, the course was accompanied by a lecturer from Technische Universität Berlin. This support always took place in the background, so that the tutors were able to offer a course independently from the first week onwards. Over the course of two semesters, this professional and didactic support was continuously reduced, so that the tutors had to assume more and more responsibility for the implementation and familiarisation of new tutors.

In any case, a professor is needed who takes formal responsibility for a course which is largely conducted by students. More so, the professor needs to stand in for the course, within the faculty and needs to take care of the anchoring of a module description as well as providing the resources for student tutors. This patronage is decisive for establishing the course at a university.

The resources available for course support are not only the well-developed building blocks, but also an inter-university network of volunteers who are committed to the further development and maintenance of the course beyond their own course participation.

References

- Baier, André. 2012. "Projektwerkstatt Blue Engineering." In *Der Systemblick Auf Innovation*, edited by Michael Decker, Armin Grunwald, and Martin Knapp. Nomos: 381–386.
- Baier, André. 2013. "Student-Driven Courses on the Social and Ecological Responsibilities of Engineers." *Science and Engineering Ethics* 19 (4). Springer: 1469–72.
- Baier, André. 2017. "Evaluation of a Stand-Alone Course on Sustainability and Engineering through Student Comparative Self-Assessment based on Learning Outcomes." In *Proceedings of the 45th SEFI Annual Conference, Angra do Heroísmo, Portugal*.
- Baier, André. 2018. *Education for Sustainable Development within the Engineering Sciences. Design of Learning Outcomes and a Subsequent Course Evaluation*. Dissertation. Technische Universität Berlin. [doi:10.14279/depositonce-8844](https://doi.org/10.14279/depositonce-8844)
- Baier, André, and Sabine Pongratz. 2013. "Collectively and Critically Reflecting on Technology and Society." In *Proceedings of the 41st SEFI Annual Conference, Leuven, Belgium*: 16–20.
- Blue Engineering. 2018. Website of the Blue Engineering Project. <http://www.blue-engineering.org>
- Creative Commons. 2009. "Creative Commons. Attribution-ShareAlike 3.0 Unported." <https://creativecommons.org/licenses/by-sa/3.0/> - Last Access 2018-05-28.
- Haan, Gerhard de. 2006. "The BLK 21 Programme in Germany: A 'Gestaltungskompetenz'-Based Model for Education for Sustainable Development." *Environmental Education Research* 12 (1). Taylor & Francis: 19–32.
- . 2010. "The Development of ESD-Related Competencies in Supportive Institutional Frameworks." *International Review of Education* 56 (2-3). Springer: 315–28.
- Kramer, Tim; Igor Lerner; Patrick Sacher; Matthias Neef and André Baier. 2019. Forthcoming. Blue Engineering - Was ist das und wie gelingt die Implementierung and (m)einer Hochschule? in: 13. Ingenieurpädagogische Regionaltagung: *Diversität und Kulturelle Vielfalt - differenzieren, individualisieren - oder integrieren? Wege zu technischer Bildung*. IPW Verlag. 2019.
- Pongratz, Sabine und André Baier. 2015. "Encouraging Engineering Students to Question Technological Solutions for Complex Ecological and Social Problems." In *Integrating Sustainability Thinking in Science and Engineering Curricula*, edited by Filho, Walter et al. Springer: 375-86. [doi:10.1007/978-3-319-09474-8_27](https://doi.org/10.1007/978-3-319-09474-8_27)

Connecting the Dots: Understanding Professional Development Needs of Istanbul's Makers for Circular Economy

Yekta Bakırlioğlu^{1,2}, Maria-Laura Ester Ramirez Galleguillos³, Ivon Bensason⁴, Asim Evren Yantaç¹ and Aykut Coşkun¹

¹ Media and Visual Arts, Koç University, Turkey

² Department of Industrial Design, Middle East Technical University, Turkey

yektab@metu.edu.tr

³ Koç University Arçelik Research Center For Creative Industries, Koç University, Turkey

⁴ KARMA Mixed Reality Lab, Koç University, Turkey

Abstract

With the dissemination and increased accessibility of makerspaces (e.g. fab labs, creative hubs, learning platforms), cities now present an opportunity for loosely managed, distributed fabrication opportunities to recapture embedded value in products and resources and re-distribute them for the benefit of the city. Istanbul Metropolitan City, with its rather large population and land, as well as 24 active makerspaces focusing on different industries and fabrication opportunities (e.g. education, entrepreneurship, sustainability), presents potential for initiating a robust network of makers (e.g. designers, engineers, craftsmen, investors, students, entrepreneurs) to explore and exploit novel ways of value recapture and to transition towards a local, Circular Economy. However, these stakeholders initially require an understanding of potential opportunities and barriers for collaboration, as well as equip themselves with skills and knowledge beyond the act of making (including alternative ways to conduct business, value recapture, Circular Design, collaboration, etc.) in order to sustain their operations from an economic perspective. This paper presents the initial results of (1) a survey revealing Istanbul's maker communities' goals, priorities, target groups, and skills related to the Circular Economy, and (2) their collaborative attempt of a future, circular economy vision for Istanbul developed as part of a generative workshop. The maker community representatives explored existing infrastructure, resources and stakeholders of Istanbul to connect the dots amongst them and reveal untapped, concealed local opportunities for collaboration and co-creation. This paper presents the analysis of these studies to reveal the professional development needs of these maker communities for transitioning towards a local, circular economy. As a result, the authors propose strategies for training, capacity building and skills development both relevant to the local context of Istanbul and in line with the global concerns around sustainability and the Circular Economy.

1 Introduction

Makerspaces, fab labs, hackerspaces and other variations of citizen fabrication spaces espousing creative communities have gained popularity and become increasingly commonplace over the last 20 years. For example, there were 150 fab labs around the world back in 2012 (Maldini et al. 2013), and at the time of writing this article there are over 1,800 fab labs registered on fablabs.io ("Labs | FabLabs" n.d.). It should also be noted that fab labs are only one variation of many spaces that accommodate makers, which are

either standalone spaces or communities, while others are part of different networks (e.g. Living Labs, Maker Faire, Coderdojo, Men's Sheds, etc).

Localization of production and consumption has long been discussed as an alternative to minimize the negative impacts of centralized mass-production, to enable local post-use opportunities and to empower local economy (Walker 2011; Dogan and Walker 2008). The advancements in digital desktop fabrication technologies (e.g. 3D printers, laser cutters) in terms of precision and reliability and their increased accessibility through digital fabrication labs or makerspaces make the localization of production and even individual fabrication possible. Coupled with global sharing of (ideally open) knowledge among makers, these technological means can espouse local, interconnected circular economies envisioned in Fab City initiative, in which the only travelling commodity is knowledge (Diez 2011). Makerspaces can enable frugal innovation in the Global South (e.g. Seo-Zindy and Heeks 2017; Redlich et al. 2016), or makers can address societal challenges and empower locals in emerging economies through the development of open-source appropriate technologies (e.g. Kostakis and Papachristou 2014; Zelenika and Pearce 2014; Buitenhuis and Pearce 2012; Pearce 2012) and the ability to create 'high-low tech' solutions (Kadish and Dulic 2015).

Beyond the global societal implications envisioned through the increased accessibility to fabrication means, knowledge and expertise, a network of local maker communities in cities presents the potential for grassroots initiatives addressing the societal and environmental challenges in their immediate environment. Open sharing of knowledge can empower these communities to undertake post-use processes such as repair and upgrading (Bonvoisin 2017), upcycling of materials (Richardson, Vittouris, and Rose 2010) and localisation of production (e.g. Kadish and Dulic 2015; Malinen et al. 2011). Such communities can utilize co-design methods to generate locally meaningful and sustainable outcomes (Ostuzzi et al. 2017) and empower vulnerable minorities such as people with disabilities (Hamidi et al. 2014). Sharing post-use related knowledge (i.e. repair, reuse and upgrading) is crucial for enabling people to undertake these activities, yet this aspect is generally overlooked (Holroyd 2017). Additionally, empirical studies indicate that the practices in makerspaces are not inherently sustainable and can easily become part of existing modes of production and consumption (Kohtala 2017; Fleischmann, Hielscher, and Merritt 2016).

Considering the vast potential of maker communities and other stakeholders in this ecosystem that (can) support these communities, there is unrealized potential for local circular economies in cities by and for citizens. Yet such communities need to be equipped with necessary tools and resources to enact this potential. For example, knowledge exchange among these communities is limited, as studies indicate the challenges makers face in actually documenting and sharing their work (Bakırlıoğlu and Kohtala 2019). There is also the challenge of sustaining these community initiatives beyond the economic challenges they face, especially when the communities are loose collectives oriented by social movement ideals – e.g. in our case, cosmopolitan localism for the Circular Economy. Hence, the challenge is encouraging existing maker communities to adopt sustainable and circular practices, in addition to promoting their own sustainability.

As part of the Pop-Machina H2020 project, our authors define 'makers' broadly as grassroots communities consisting of a variety of stakeholders collaborating on designing, fabricating, sharing knowledge, etc., for tackling local social and environmental issues and/or for collaboration for innovation and technology development. These stakeholders may be makers actively undertaking the 'making', citizens participating in the 'making' at varying levels from idea generation to assessment and fabrication, local and regional

governments supporting these grassroots collaborations and providing the infrastructure for them, NGOs and other organizations providing the capital necessary for these activities, and organizations focusing on the generation and dissemination of knowledge. Our authors are in the position of the latter as a group of researchers exploring the opportunities presented by such grassroots communities on establishing a local, generative, circular economy in Istanbul, Turkey. While the general purpose of the Pop-Machina project is to enhance, support and monitor Circular Maker Communities in 7 partner cities, in this paper we focus on Istanbul and aim to demonstrate the landscape of the local maker culture and understand their visions for a city-scale circular economy to identify potential areas for intervention in terms of professional development. Following this line of thought, the next section presents the methodology utilized to understand the professional development needs of Istanbul makers. It should be noted that the below set of methods were utilized to reveal an expanded set of data more than the professional development needs, however, the first analysis was about these needs to inform the following stages of the project.

2 Methodology

The sampling process started with desk research about the maker initiatives currently being developed in Istanbul and resulted in an initial list of 80 initiatives. After applying the inclusion/exclusion criteria (e.g. being part of the supply chain of making, enhancing community involvement, tackling environmental or social issues) developed by the Pop-Machina team, a final list of 23 maker initiatives was reached, and the members of these initiatives were invited to participate in the following activities.

The survey was developed in collaboration with other partners of the Pop-Machina project and aimed to examine the visions, skills, collaborations and structures of maker movement stakeholders and maker initiatives. The survey was shared with the 23 maker initiatives identified in the first stage by email, was answered by 18 of them, and collected information regarding geographic/spatial repartition, network, interactions, stakeholder visions, strengths, weaknesses, opportunities and barriers of cities. This information was analysed to reveal recurrent patterns especially around characteristics of Istanbul in terms of stakeholders' needs, skills and development opportunities regarding making.

The generative workshop aimed to introduce the Pop-Machina project to the maker community representatives and other related stakeholders (29 people from 25 initiatives and organizations) in the Istanbul maker ecosystem and to answer these main questions: what are the needs, resources, and goals of Istanbul for pursuing the four visions of the project [i.e. social cohesion (enhancing social connection between and within communities), circular and distributed production, sustainability (improving environmental quality and minimizing the depletion of resources), and urban regeneration (improving wellbeing and value of neighbourhoods and cities)], how should the project address these needs, resources, and goals, who are the people and organizations in Istanbul that need to be involved and become partners in the Pop-Machina project. As a result of this activity, the purpose was to have a better understanding of the current state in Istanbul in terms of needs, resources, goals, challenges and opportunities for interventions in relation to the integration of circular economy thinking into making activities. Stakeholders from environmental and sustainability organizations of the maker ecosystem were invited to include potential partners interested in promoting the circular economy through the maker movement.

The workshop consisted of three stages. The first stage was an envisioning activity around a 'city timeline' to gather information about the past, present and future of the city, which was then used to identify the

needs and resources of Istanbul’s ecosystem. The second was a mapping activity to match identified needs and resources with the Pop-Machina values, outputs, and actions, as well as to identify new stakeholders that should be considered in the project. The third one was a geographical mapping activity about the needs, resources, and stakeholders related to the values of Pop-Machina in Istanbul.

For the purposes of understanding the professional development needs, the data from the survey and the workshop was analysed accordingly. The landscape of Istanbul maker culture was analysed in terms of the types and activities of existing stakeholders, and their visions for a local circular economy was analysed to unravel their priorities. The workshop revealed more information about vision categories, especially stakeholders’ understanding of them as well as the gaps within. The needs, values and expectations of the stakeholders as reflected in the workshop also revealed what they consider they need in terms of professional development, while on the other hand gave our authors the opportunity to compare those with the larger distributed, regenerative circular economy vision of the Pop-Machina project. The following section outlines only the results directly related to the professional development needs of the makers and other related stakeholders in Istanbul.

3 Results

3.1 Maker Culture in Istanbul

The maker initiatives in Istanbul have varying foci in terms of the practices they undertake. There are initiatives that function as incubation hubs (e.g. Arcelik Garage, Acibadem Biodesign Centre, KWORKS), local and central government initiatives aiming to empower citizens on fabrication technologies (e.g. Basaksehir Living Lab, IMM Zemin Istanbul), and private digital fabrication labs (e.g. Makers Turkey, Maker Cocuk). Some initiatives focus on specific societal challenges, such as RobotEl focusing on robotic prosthetic hands for children with Amniotic Band Syndrome. One of the outcomes of the survey was to identify the types of these initiatives (e.g. knowledge, capital, administration) and to learn more about the kind of activities they are engaged in. Figure 1 presents an overview of the stakeholder types and activities.

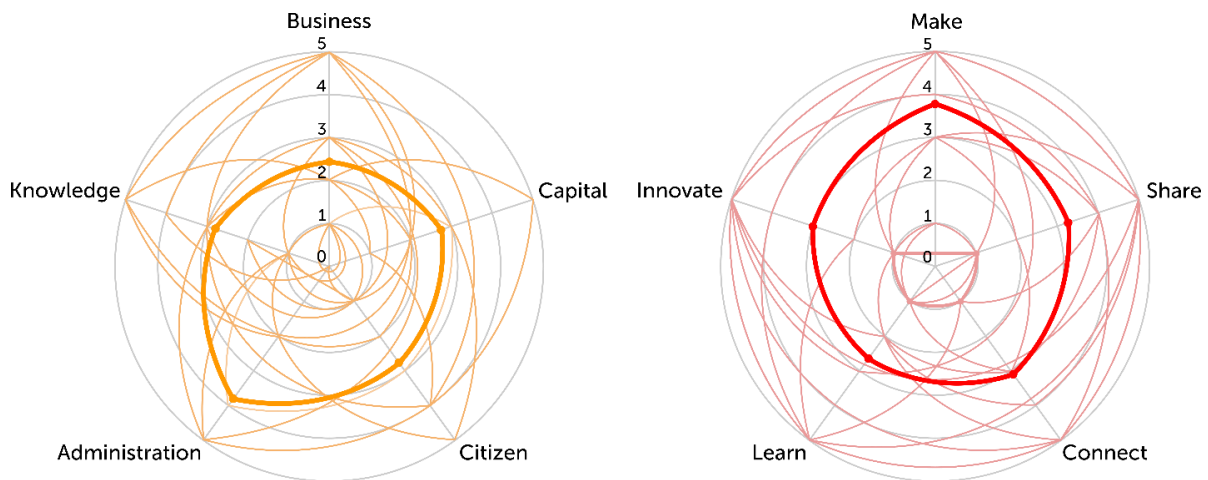

Figure 1: Types of stakeholders in Istanbul maker culture (left) and their types of actions (right) as revealed in stakeholder surveys

The left side of Figure 1 presents an overall breakdown of stakeholder types in Istanbul maker landscape. It should be noted that only three of the maker initiatives identified themselves as only one type of stakeholder, and most of them ranked their various roles as stakeholders. Each light-coloured line represents a stakeholder and how they identify themselves, while the thicker, darker line indicates the general distribution in Istanbul. It is visible that the ‘administration’ type of stakeholders are more common-place compared to others, which the authors attributed to the increasing number of initiatives set up by the various departments of the local and central government. Then again, while there are three initiatives that primarily self-identify as businesses, others do not specifically focus on the business implications of their initiatives.

The right side of Figure 1 identifies the activities these maker initiatives undertake in Istanbul. There is an even distribution among types of actions, ‘making’ not surprisingly being the prominent type of action. Sharing the outcomes and connecting with other potential stakeholders are deemed as secondary, however, it remains to be seen if this is actually the case. Finally, probably the most interesting outcome of this survey is the fact that the average of ‘learning’ activity is at the end of the list. As mentioned before, making typically involves collaboration and knowledge exchange, yet for Istanbul makers, it is somehow the least deployed activity. The reasons for this will be questioned in the following stages of this study.

3.2 *Perspectives on city-scale Circular Economy*

Pop-Machina concerns itself with the development of an urban vision through grassroots development and involvement, and this focus requires a collaborative attempt at forming the needs of citizens as well as their aspirations for their city. For the Istanbul case, Figure 2 presents the visions the maker initiatives are concerned about, as revealed by the survey. As can be seen, the urban development, or the regeneration of the city, is a priority for Istanbul makers, and production and sustainability are secondary. What is interesting to observe is that, although there are maker initiatives highly concerned with social cohesion, it is still the last item on the list on average. This is an interesting outcome considering the societal challenges in urban areas, as well as the challenges more prominent in Turkey, such as refugees (e.g. International Crisis Group 2018) and poverty (e.g. Soytemel 2013).

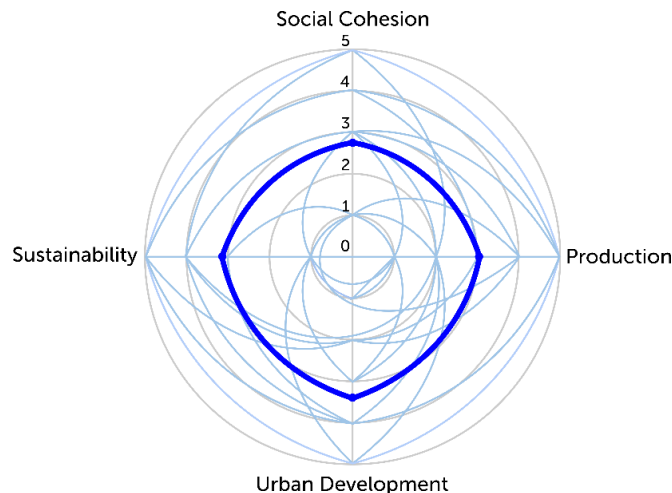

Figure 2: The visions of stakeholders in Istanbul maker culture as revealed in stakeholder surveys

During the workshop, Istanbul makers have detailed their visions and the routes they and other involved stakeholders should take to reach there. They have identified that existing maker communities lack

communication amongst them, which hinders the potential for collaboration. While they envision localized and decentralized production as empowering for these initiatives on the city and neighbourhood scale, the lack of communication and collaboration – which may be interpreted as coordination – is a challenge that needs to be overcome. This lack also presents itself as inaccessibility to relevant experts.

For all the vision categories, the awareness of the general public and policymakers came to forth as a challenge and a goal. For the sustainability category, it refers to raising awareness of carbon emissions, waste management and demand-driven fabrication. To enable local and demand-driven production, forging a culture of collaborative production came to forth as a priority. In addition, the availability and accessibility of venues where makers can sell and/or barter with their fabrications are considered to be an effective driver.

3.3 Training needs revealed

The workshop participants all mentioned the need for raising awareness of novel technologies and fabrication techniques, as well as sustainability issues. In addition to the suggestions for the general public and policymakers, they also mentioned their own training needs which can be grouped as follows:

- *Legislative processes*, especially around setting up and sustaining makerspaces, incorporating businesses with appropriate forms of association enabling and encouraging collaborative production and social good, tax-related and incentive eligibility issues, profit sharing strategies encouraging collaboration and cooperation vs. traditional partnership, employment and subcontracting strategies, etc.
- *Culture of Collaboration*, especially on communication, sharing projects and initiating collaboration among maker initiatives and with other stakeholders according to varying expertise. This also includes engaging the local community and general public to create visibility of activities, projects and alike.
- *Technical Training*, mostly focused on training ‘mid-level technical staff’ for makerspaces, capable of operating, maintaining and troubleshooting digital fabrication tools such as 3D printers and laser cutters.

These training needs are very valid considering the city visions and pathways they have formed. However, the latter is somehow problematic, as it immediately creates a hierarchical relationship among the members of the makerspace and will require further inquiry. In addition to these, as the moderators of the workshops, the authors also observed additional areas of intervention:

- There seems to be a limited understanding of sustainability among the Istanbul makers – one that puts emphasis on recycling/upcycling and composting yet overlooks *other strategies of the Circular Economy*, e.g. repair, refurbishing, remanufacturing, cascading, biochemical extraction.
- There are other institutions, non-governmental and governmental organizations, and *non-maker stakeholders* directly affecting and affected by a potential, city-level circular economy; yet, these *non-makers* (e.g. building managers, local cafés, etc.) were not mentioned during the workshop.

4 Conclusions

This paper presents the initial results of a survey and a generative workshop conducted with maker initiatives and related stakeholders in Istanbul with the purpose of understanding the current maker culture in Istanbul and revealing the opportunities for a local, regenerative circular economy. While the outcomes of this research are extensive and detailed, here our authors present the initial results informing the next

stages of this study by focusing on the training needs and wants of maker initiatives, not only for establishing a grassroots circular economy but also for sustaining it in the long-term.

The results indicate that Istanbul makers envision the city in the future brimming with salvaged green areas, prospering through a grounded distributed production culture to recapture embedded value in perceived waste and to nourish the cultural acts of making, and achieving zero-emission goals. To this end, while awareness of environmental and social issues among these makers can be observed, a lack of critical and comprehensive understanding of the opportunities for such a circular economy can also be observed. As such, in the next stages of Pop-Machina, our authors aim to make these opportunities more visible through a set of activities and training sessions. An initial list of such activities is as follows:

1. *It's more than recycling!* – a set of masterclasses introducing the opportunities of maker initiatives in CE strategies other than recycling. These sessions will be more informative and illustrative, rather than practice-based, with many cases from around the world to showcase the potential of maker initiatives in adopting different CE strategies.
2. *Maker Symbiosis Workshop* – inspired by *industrial symbiosis* (e.g. Rosado and Kalmykova 2019), this is a set of activities where makers map the local maker ecosystem, including the non-maker stakeholders, to reveal the opportunities for value recapture amongst them and collaboration.
3. *Maker Journeys through Legislation* – experience-sharing sessions where makers explain how they handled legislative matters, categorized according to different types of activities they conducted/participated.

While this is an initial list emerging from the analysis of the survey and workshop outcomes, our authors are planning to conduct interviews with makers to reveal more information about the ‘learning’ needs of the Istanbul maker ecosystem. The end-goal is to prepare a set of activities which can be implemented not only in Istanbul but also in other cities according to their own needs, preferences and visions.

Acknowledgements

This paper is supported by European Union’s Horizon 2020 research and innovation programme under grant agreement No 821479, project Pop-Machina (Collaborative production for the circular economy; a community approach).

References

- Bakırlioğlu, Yekta, and Cindy Kohtala. 2019. “Framing Open Design through Theoretical Concepts and Practical Applications: A Systematic Literature Review.” *Human-Computer Interaction* 34 (5–6): 389–432
- Bonvoisin, Jérémy. 2017. “Limits of Ecodesign: The Case for Open Source Product Development.” *International Journal of Sustainable Engineering* 10 (4–5): 198–206.
- Buitenhuis, A. J., and J. M. Pearce. 2012. “Open-Source Development of Solar Photovoltaic Technology.” *Energy for Sustainable Development* 16 (3): 379–88. <https://doi.org/10.1016/j.esd.2012.06.006>.
- Diez, Tomas. 2011. “Fab City Whitepaper: Locally Productive, Globally Connected Self-Sufficient Cities.” <https://fab.city/uploads/whitepaper.pdf>.
- Dogan, Cagla, and Stuart Walker. 2008. “Localisation and the Design and Production of Sustainable Products.” *International Journal of Product Development* 6 (3–4): 276–90.
- Fleischmann, Katja, Sabine Hielscher, and Timothy Merritt. 2016. “Making Things in Fab Labs: A Case Study on Sustainability and Co-Creation.” *Digital Creativity* 27 (2): 113–31.

- Hamidi, Foad, Melanie Baljko, Toni Kunic, and Ray Feraday. 2014. "Do-It-Yourself (DIY) Assistive Technology: A Communication Board Case Study." In *Computers Helping People with Special Needs*, 287–94. Springer.
- Holroyd, Amy Twigger. 2017. "From Stitch to Society: A Multi-Level and Participatory Approach to Design Research." *Design Issues* 33 (3): 11–24. https://doi.org/10.1162/DESI_a_00448.
- International Crisis Group. 2018. "Turkeys Syrian Refugees: Defusing Metropolitan Tensions." Europe Report 248. <https://www.crisisgroup.org/europe-central-asia/western-europemediterranean/turkey/248-turkeys-syrian-refugees-defusing-metropolitan-tensions>.
- Kadish, David, and Aleksandra Dulic. 2015. "Crafting Sustainability: Approaching Wicked Environmental Problems through High–Low Tech Practice." *Digital Creativity* 26 (1): 65–81.
- Kohtala, Cindy. 2017. "Making 'Making' Critical: How Sustainability Is Constituted in Fab Lab Ideology." *The Design Journal* 20 (3): 375–94. <https://doi.org/10.1080/14606925.2016.1261504>.
- Kostakis, Vasilis, and Marios Papachristou. 2014. "Commons-Based Peer Production and Digital Fabrication: The Case of a RepRap-Based, Lego-Built 3D Printing-Milling Machine." *Telematics and Informatics* 31 (3): 434–43. <https://doi.org/10.1016/j.tele.2013.09.006>.
- "Labs | FabLabs." n.d. Accessed February 10, 2020. <https://www.fablabs.io/labs>.
- Maldini, Irene, Bas Van Abel, Alex Schaub, Frank Kresin, and Javier Gimeno-Martinez. 2013. "The FabLab Amsterdam Users: A Survey on Their Profile and Activity .," no. February: 1–16. <https://waag.org/sites/waag/files/Publicaties/fablabusersreport.pdf>.
- Malinen, Tiina, Teemu Mikkonen, Vesa Tienvieri, and Tere Vadén. 2011. "Community Created Open Source Hardware: A Case Study of" ECars-Now!"" *First Monday* 16 (5).
- Ostuzzi, Francesca, Lieven De Couvreur, Jan Detand, and Jelle Saldien. 2017. "From Design for One to Open-Ended Design. Experiments on Understanding How to Open-up Contextual Design Solutions." *The Design Journal* 20 (sup1): S3873–83. <https://doi.org/10.1080/14606925.2017.1352890>.
- Pearce, Joshua M. 2012. "The Case for Open Source Appropriate Technology." *Environment, Development and Sustainability* 14 (3): 425–31.
- Redlich, Tobias, Sonja Buxbaum-Conradi, Sissy-Ve Basmer-Birkenfeld, Manuel Moritz, Pascal Krenz, Babsile Daniel Osunyomi, Jens P Wulfsberg, and Susanne Heubischl. 2016. "OpenLabs--Open Source Microfactories Enhancing the FabLab Idea." In *System Sciences (HICSS), 2016 49th Hawaii International Conference On*, 707–15. IEEE.
- Richardson, Mark, Alex Vittouris, and Geoff Rose. 2010. "Socialised Transport: Increasing Travel Mode Diversity through Open-Source Vehicle Design, Upcycling, Natural Production and Distributed Production Methods." In *Australasian Transport Research Forum*.
- Rosado, Leonardo, and Yuliya Kalmykova. 2019. "Combining Industrial Symbiosis with Sustainable Supply Chain Management for the Development of Urban Communities." *IEEE Engineering Management Review* 47 (2): 103–14.
- Seo-Zindy, Ryoung, and Richard Heeks. 2017. "Researching the Emergence of 3D Printing, Makerspaces, Hackerspaces and Fablabs in the Global South: A Scoping Review and Research Agenda on Digital Innovation and Fabrication Networks." *The Electronic Journal of Information Systems in Developing Countries* 80 (1): 1–24.
- Soytemel, Ebru. 2013. "The Power of the Powerless: Neighbourhood Based Self-Help Networks of the Poor in Istanbul." *Women's Studies International Forum* 41 (P1): 76–87.

Walker, Stuart. 2011. *The Spirit of Design: Objects, Environment, and Meaning*. London: Earthscan.

Zelenika, I., and J. M. Pearce. 2014. "Innovation through Collaboration: Scaling up Solutions for Sustainable Development." *Environment, Development and Sustainability* 16 (6): 1299–1316.

A Connected Curriculum: Integrating the United Nations Sustainable Development Goals within and across the Curriculum

John Barimo, Catherine O'Mahony, Gerard Mullally, Edmond Byrne, John O'Halloran, Darren Reidy,
and Maria Kirrane

University College Cork, Republic of Ireland

j.barimo@ucc.ie

Abstract

Integration of SDGs across university wide curricula, in most cases, appears compartmentalized and lacking transdisciplinary perspective. The Connected Curriculum framework at University College Cork calls for reorienting curricula towards sustainability with the explicit integration of SDGs and involves not just transmitting knowledge about sustainability, but cultivating the mindset required for teaching staff to guide and equip students to address the critical challenges underpinning sustainable development. The holistic interconnected nature of SDGs has the potential to create context for transdisciplinary learning experiences.

This presentation showcases a dynamic framework highlighting where spaces exist in curricula to integrate SDGs by focusing on action-oriented outcomes. The project aims to provide equal access to ESD, often limited through the informal curriculum, to foster the development of globally minded and action-oriented citizens who are empowered to develop innovative solutions for a sustainable future.

Identifying Students' Sustainability Preferences to Improve Design Team Performance

Elise Barrella¹, Justyn Girdner², Robin Anderson³ and Mary Katherine Watson⁴

¹Department of Engineering, Wake Forest University, NC, USA

barrelem@wfu.edu

²Department of Engineering, James Madison University, VA, USA

³Department of Graduate Psychology, James Madison University, VA, USA

⁴Department of Civil & Environmental Engineering, The Citadel, SC, USA

Abstract

In this paper, we discuss evidence from two studies, which use a mix of individual and team tasks to uncover students' knowledge and skills related to sustainable design. The research explores two questions: (1) Could a team with a mix of individual student sustainability profiles influence individual team members' learning? (2) Does a diverse, balanced team enhance project performance? When we look at individual students, preferences or affinities emerge that indicate socially-, environmentally-, economically-, or technically-minded individuals. As part of a team, students influence each other's design decisions, often by bringing new knowledge or a different perspective into a discussion. Team composition that prioritizes a mix of individual preferences could be a valuable strategy for sustainable design, and help team members appreciate the value of different sustainability aspects.

1 Introduction

Typical sustainable development frameworks emphasize pursuit of at least three objectives: social equity/quality of life, environmental protection/restoration, and economic vitality. In theory, sustainable design seeks harmony among all objectives, although in reality designers make trade-offs to achieve technical objectives or stakeholder approval. We have conducted various studies to understand how engineering students conceptualize and apply sustainability principles to make design decisions. While examining how students perform and develop cognitive flexibility on sustainability-related tasks, we have made interesting, and at times unexpected, observations of individual and group behaviours. In particular, in studies involving concept mapping and application of a design rubric, we noted that students tend to focus on one or two aspects of sustainability. At the group level, engineering students seem to undervalue the economic dimension and, depending on the student population, over-represent either social or environmental dimensions. This observation has been well-documented and assumes that students ideally should develop a balanced understanding of sustainability pillars. When we look at individual students, profiles emerge that indicate socially-, environmentally-, economically-, or technically-minded individuals.

This exploratory work is guided by two questions: (1) Could a team with a mix of individual student sustainability profiles influence individual team members' learning? (2) Does a diverse, balanced team enhance project performance? Our paper examines these questions starting with the literature on sustainability attitudes/behaviors and engineering team formation/performance. We then describe our previous studies that led to these questions and provide preliminary findings that merit further investigation.

2 Background Literature

2.1 Student Attitudes about Sustainability

The *Nature Sustainability* Expert Panel (2019) observed that “Design behaviour for sustainability is part of an interdependent network of judgments and decisions that are shaped by specific professional and socioeconomic contexts and that must consider both existing and preferred states of complex Anthropocene situations.” Individual and interpersonal factors, among others, can significantly impact design behaviour toward or away from sustainability. A key challenge is that designers’ mental models must accommodate the range and interdependencies of multiple factors that influence human behaviour, including cognitive biases. Individuals bring different mental models to a task, which results in different weighting of quantitative and qualitative decision factors (The *Nature Sustainability* Expert Panel, 2019). This challenge affects both student and professional designers and teams.

Research shows that students exposed to sustainability-related problems during their education are more likely to want to tackle those types of challenges in their career (Shealy et al., 2015) and engineering experiences related to sustainability may help broaden participation in engineering programs and career paths (Klotz et al., 2014). Survey and other self-report instruments are a common approach for understanding student attitudes and behaviours. For example, Shealy et al. (2017) developed and piloted a new survey instrument to measure undergraduate engineering students’ climate change literacy, their engineering identity, career motivations, and agency to address sustainability through engineering. According to critical engineering agency theory, the opportunity to make real change in their world leads to increases in students’ learning and interest in engineering, and in this case to take action to reduce climate change impacts and support sustainability (Shealy et al., 2017). Perrault and Scott (2017) found through an online survey that an effective way to influence college students’ behavioural intentions toward sustainability is to combine fear inducing messages about sustainability threats with messages that will increase students’ self-efficacy. Whitley et al. (2016) demonstrated that values are a strong predictor of sustainability behaviour among college students and observed the importance of this finding because undergraduate students are susceptible to changes in their values, beliefs, and norms during their college years. Using multivariate analysis and direct measures, Svanström and colleagues showed that students’ demonstrated learning of sustainable development concepts can be influenced by their backgrounds, participation in different learning activities, and the type of assessment used to capture learning (Svanström et al., 2018). All of these studies help inform educational practices and environments that encourage individual students to act more sustainably in their personal and professional lives.

2.2 Design Teams and Formation

Maximizing the effectiveness of engineering teams has been the focus of volumes of research, including many interdisciplinary and multidisciplinary studies (see Borrego et al., 2013 for such a review). This research has focused on both professional teams and student teams (Little & Hoel, 2011). Early team effectiveness studies largely focused on the most effective methods for building teams across disciplines with a focus on how disciplinarily diverse teams impact outcomes related to both the team process and the quality of the product produced by the team. Over the decades research on the effectiveness of teams has moved to examining other types of diversity within teams, including cognitive differences. Mello and Rentsch (2015) examined the vast literature around the broad and complicated concept of cognitive

diversity. Other researchers have examined the impact of cognitive diversity related to specific team outcomes such as creativity (Wang et al., 2016). Culp and Smith (2001) moved beyond cognitive diversity to examine the impact of different personality approaches on engineering projects. The researchers concluded that “project teams can increase their chances of success by understanding and capitalizing on different behavioural styles related to psychological types” (p. 33). Numerous team formation approaches have been developed and tested to optimize engineering team performance. For example, balancing students’ preferred team roles (Henry & Stevens, 1999) or accounting for multiple criteria using a web-based tool (Layton et al., 2010). However, none of these studies have examined the impact of how different engineers with different foci (Ecological, Social, Economic, or Technical) impact the engineering team process and outcomes. Rather than assign teams based on complementary technical skills or teamwork styles, might we form teams with cognitive diversity related to sustainability?

3 Methods

3.1 Concept Mapping Study

Concept maps were developed in 1972 by J. Novak as a way to track changes in children’s mental models of science (Novak & Musonda, 1991). Since Novak’s original work, concept maps have been used frequently as assessment tools in engineering education, including for tasks related to sustainability (e.g., Watson et al., 2016). One goal for concept mapping is to allow students to represent their mental models in a tangible way. In a previous study, 23 engineering (n = 8) and non-engineering (n = 15) students at a mid-sized U.S. public university completed two listing and two concept mapping tasks in one of four randomly assigned sequences while wearing an electroencephalograph (EEG) cap to quantify cognitive workload. Our study was designed in collaboration with a research team at a U.S. public research university (Hu et al., 2019). Students were prompted to create concept maps and lists related to four topics: Water Availability, Climate Change, Food Sustainability, and Renewable Energy. These topics were randomly assigned so that each participant saw all four topics and made concept maps on either Water Availability and Climate Change or Food Sustainability and Renewable Energy. Students created lists for the other two topics. More details on the research design can be found in previous publications (Barrella et al., 2018). This paper focuses on the concept map scores.

Many scoring methods have been used to evaluate concept maps, and we used one quantitative and one qualitative scoring approach: the Traditional Method and Categorical Method (see Watson et al., 2016), respectively. This paper will focus on our results from the Categorical Method which analyses the frequency and interconnectedness of different categories of concepts. Scoring a concept map with the Categorical Method requires the scorer to first categorize each concept, and for this study each concept was assigned to either the Environmental, Social, Economic, or Technical category. After categorization, the concept map is scored based upon number of interconnections between different categories. In this study, two researchers independently categorized all concepts for each concept map before meeting to compare scores, and interrater reliability was determined from Cohen’s Kappa. The agreement between scores was generally high with Kappa’s of 0.78, 0.67, 0.60, and 0.57 for concept maps related to Climate Change, Water Availability, Food Sustainability and Renewable Energy respectively. All analysis was completed using consensus scores that the two researchers agreed upon after discussion.

3.2 Rubric Study

In a second study, 51 junior engineering students from two course sections of capstone design at the same mid-sized public university evaluated their capstone projects with a new Sustainable Design Rubric (see Table 1 for criteria). Each student belonged to one of fifteen capstone teams and was assigned to evaluate their projects against a randomly assigned subset of rubric criteria. Capstone teams then completed a consensus process to arrive at a final rating for each criterion. In addition to calculating descriptive statistics for individual and team scores, we also reviewed correlations between criteria and evaluated the quality of students' evidence for their ratings. The methods for this study are described in Barrella et al., 2019.

Table 1: Criteria composing the Sustainable Design Rubric (Barrella et al., 2019).

1. Minimizes the use of non-replenishable raw materials; requires minimal energy input or uses renewable energy sources
2. Minimizes quantity of consumable waste (e.g., water, materials) output; manages quantity and quality (benign, usefulness) of waste
3. Protects or enhances natural ecosystems (water, air, soils, flora, fauna, etc.)
4. Identifies and engages stakeholders (external to project team) in the design process
5. Addresses needs of diverse stakeholders, acknowledging culture and other differences among individuals and groups
6. Protects human health and physical safety of users and society
7. Promotes human well-being and enhances quality of life for users and society
8. Evaluates economic impacts of environmental design criterion
9. Evaluates economic impacts of a social design criterion
10. Considers affordability for users and/or demonstrates cost competitiveness or cost reduction for client/sponsor
11. Evaluates economic costs and benefits to inform decisions
12. Final design impacted by trade-offs among environmental, social, and economic criteria and reflects balance of dimensions
13. Uses and/or creates innovation(s) in its specific field to achieve sustainability
14. Worked with experts from other disciplines (i.e., outside engineering) to enhance process or final design

4 Results and Findings

4.1 Profiles Emerging from Concept Map Study

Student preferences emerged through categorical scores demonstrating depth in one or two sustainability categories, with less emphasis on other categories. In total, participants' concept maps included 41% Ecological, 21% Social, 7% Economic, and 31% Technical concepts. We observed significant variations across students. For example, one participant's breakdown was 72% Ecological, 16% Social, 0% Economic, and 12% Technical, whereas another's was 7% Ecological, 19% Social, 15% Economic, and 59% Technical. If a student devoted at least one third of their concepts to a category, they were defined as having an affinity for that category. Most students' concept maps demonstrated an affinity for one or two categories. Frequently, students displayed a tendency to overall emphasize a single aspect of sustainability. Only two concept maps from distinct participants showed no affinity for any category. Even in cases where students had split affinities between their two concept maps, each map was likely to have a high affinity for at least one category. Approximately 78% percent of concept maps included at least one category accounting for greater than or equal to 50% of the concepts for that map. Of these high affinity concept maps, there were

three instances of 100% affinity. Among these high affinity scores, the mean percentage of concepts belonging to one category was 67%.

Student concept maps were classified according to their primary affinity. Half points were awarded to a category when the concept map demonstrated split affinities with the same number of concepts in two categories. As shown in Figure 1A, student affinities with Ecological, Social, Economic, and Technical categories were 21.5, 8.0, 2.5, and 20 concept maps respectively. There were 54 concept maps overall, and two concept maps showed no affinity. If a student had an affinity for a certain category in their first concept map, they were more likely to have an affinity for that category in their second concept map. Students who showed an affinity for the same category in both concept maps made up 59% of the sample.

In addition to analysing differences across students, we also observed differences in concept distributions across sustainability prompts (Figure 1B). One notable trend was that concepts from renewable energy concept maps showed the most technical concepts. The strong technical affinity for the renewable energy prompt may be due to current economic emphasis on developing new or more efficient technologies to compete with fossil-fuels. Water availability and climate change showed a similar composition of concepts between the four categories. While individual students showed similar affinities across concept mapping tasks, those affinities can be influenced by the problem context.

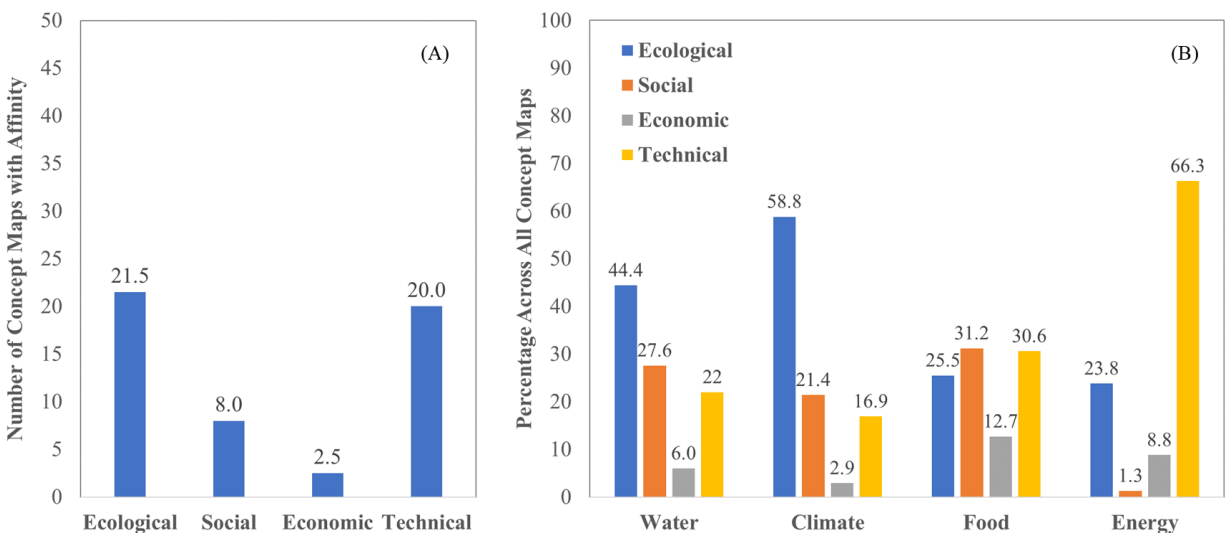

Figure 1: (A) Distribution of student affinities (defined as devoting 33.3% or more of total concepts in a concept map to a category). (B) Distribution of concepts across categories by concept map topic (water availability, climate change, food sustainability, or renewable energy).

4.2 Individual and team performance from Rubric Study

After completing individual and team scoring of their design projects using the Sustainable Design Rubric (see criteria in Table 1), students indicated that consensus discussions with their teams were beneficial and often introduced them to perspectives that they had not considered. Discussions often led to a change in score compared to one or more of the student reviewers and/or provided additional evidence for consensus scores (Table 2). Also, most students identified areas for additional learning or project improvement as a

result of consensus scoring. We are finding similar results from an unpublished study involving a different student population.

Table 1: *Mean individual and consensus scores by criterion.* (Adapted from Barrella et al., 2019)¹

Criterion	Individual <i>M</i> (<i>SD</i>)	Consensus <i>M</i>
Env1: Non-replenishable resources	1.53 (.78)	1.73
Env2: Waste	1.56 (.86)	1.73
Env3: Ecosystem protection	1.43 (.82)	1.33
Soc1: Stakeholder engagement	2.56 (.50)	2.67
Soc2: Diverse cultures and needs	1.68 (.75)	1.67
Soc3: Human health/safety	2.09 (.69)	2.40
Soc4: Quality of life	2.41 (.71)	2.67
Econ1: Economic/environment	1.55 (.95)	1.53
Econ2: Economic/social	1.62 (.90)	1.93
Econ3: Affordability, cost competitiveness	2.10 (.82)	2.13
Econ4: Costs and benefits	1.61 (.89)	1.73
Trade-offs	1.57 (1.08)	1.73
Innovations in field	1.97 (.96)	1.87
Interdisciplinary experts	1.77 (.94)	1.80

¹Shaded cells indicate a perceptible change between mean individual and consensus scores.

5 Implications for Team Formation

Previous studies involving other groups of engineering students have also revealed individual student affinities, often toward either environmental or social aspects (Watson & Barrella, 2016). Also consistent with prior studies (see Barrella & Watson, 2018), the economic category was underrepresented in the concept maps with just over a tenth of the representation of the Ecological and Technical categories. The social orientation was lower than expected based on prior studies involving the same engineering student population and considering the mix of engineering and non-engineering majors.

We recognize that our evidence is limited by the scope of the original studies which did not directly investigate how individual student sustainability competencies and preferences impacted team performance. However, our observations lead to interesting research questions that we would like to investigate. For example, rather than emphasize each student demonstrating mastery of sustainability concepts across the different domains, could we help faculty and students become aware of individual strengths and predispositions and identify complementary teammates? We would still expect students to need a basic understanding of sustainable design and factors related to environment, economy, and society so that they are open to working with teammates who bring different knowledge and skills in each area.

Numerous approaches from the literature could be used to identify student affinities (e.g., survey instruments, student essay, concept maps). How might this diversity of experience with sustainability concepts trade-off with other personal factors that could enhance or limit a team's performance? We would not want affinities to lead to unmanageable conflict (Mitchell et al., 2009). Our goal would be studying how sustainability profiles may assist with team formation and improve performance on sustainable design tasks.

We hypothesize that exposing individuals' cognitive biases with respect to sustainability and balancing team composition across affinities could improve team performance on a design project.

6 Conclusions

Individual student and collective team knowledge, skills, and work styles are important factors in team performance. Based on preliminary analysis, team composition that prioritizes a mix of individual affinities could be a valuable strategy for sustainable design, and help team members appreciate the value of different sustainability aspects. Future work could have implications for both student and professional design teams, particularly if combined with activities to help team members identify their cognitive biases with respect to sustainability and to utilize the team's diversity of thought.

Acknowledgements

This paper is based upon work supported by the National Science Foundation under Grant No. 1811170. Any opinions, findings, and conclusions or recommendations expressed in this material are those of the authors and do not necessarily reflect the views of the National Science Foundation.

References

- Barrella, E., Cowan, C. M., Girdner, J. D., Watson, M. K., & Anderson, R. 2019. Student Experience and Learning with a Formative Sustainable Design Rubric. *2019 ASEE Annual Conference & Exposition*, June 15-19, Tampa, Florida. <https://peer.asee.org/33293>
- Barrella, E. M., & Watson, M. K. 2018. Identifying Imbalances in Sustainable Design Curricula: A Spotlight on Economic Sustainability. *Engineering Education for Sustainable Development Conference 2018*, June 3-6, Glassboro, New Jersey.
- Barrella, E., Cowan, C., Girdner, J., Anderson, R., & Watson, M. K. 2018. Using neuroeducation methods to compare engineering student performance on linear and systems tasks. *2018 IEEE Frontiers in Education Conference (FIE)*, October 3-6, San Jose, CA.
- Borrego, M., Karlin, J., McNair, L. D., & Beddoes, K. 2013. Team effectiveness theory from industrial and organizational psychology applied to engineering student project teams: A research review. *Journal of Engineering Education*, **102**(4), 472-512.
- Culp, G., & Smith, A. 2001. Understanding psychological type to improve project team performance. *Journal of Management in Engineering*, **17**(1), 24-33.
- Henry, S. M., & Stevens, K. T. 1999. Using Belbin's leadership role to improve team effectiveness: An empirical investigation. *Journal of Systems and Software*, **44**(3), 241-250.
- Hu, M., Shealy, T., Grohs, J., & Panneton, R. 2019. Empirical evidence that concept mapping reduces neurocognitive effort during concept generation for sustainability. *Journal of Cleaner Production*, **238**, 117815.
- Klotz, L., Potvin, G., Godwin, A., Cribbs, J., Hazari, Z., & Barclay, N. 2014. Sustainability as a Route to Broadening Participation in Engineering. *Journal of Engineering Education*, **103**(1), 137-153.

- Layton, R. A., Loughry, M. L., Ohland, M. W., & Ricco, G. D. 2010. Design and Validation of a Web-Based System for Assigning Members to Teams Using Instructor-Specified Criteria. *Advances in Engineering Education*, **2**(1), n1.
- Little, A., & Hoel, A. 2011. Interdisciplinary Team Teaching: An Effective Method to Transform Student Attitudes. *Journal of Effective Teaching*, **11**(1), 36-44.
- Mello, A. L., & Rentsch, J. R. 2015. Cognitive diversity in teams: A multidisciplinary review. *Small Group Research*, **46**(6), 623-658.
- Mitchell, R., Nicholas, S., & Boyle, B. (2009). The role of openness to cognitive diversity and group processes in knowledge creation. *Small Group Research*, **40**(5), 535-554.
- Novak, J. D., & Cañas, A. J. 2008. The theory underlying concept maps and how to construct and use them. *Florida Institute for Human and Machine Cognition, Technical Report*.
- Perrault, E. and Clark, S. 2018. Sustainability attitudes and behavioural motivations of college students: Testing the extended parallel process model. *International Journal of Sustainability in Higher Education*, **19**(1), 32-47. <https://doi.org/10.1108/IJSHE-09-2016-0175>
- Shealy, T., & Godwin, A., & Gardner, H. M. 2017. Survey Development to Measure the Gap Between Student Awareness, Literacy, and Action to Address Human-caused Climate Change. *2017 ASEE Annual Conference & Exposition*, June 25-28, Columbus, Ohio. <https://peer.asee.org/28891>
- Shealy, T., Valdes-Vasquez, R., Klotz, L., Potvin, G., Hazari, Z., Cribbs, J., & Godwin, A. (2015). Career Outcome Expectations Related to Sustainability among Students Intending to Major in Civil Engineering. *Journal of Professional Issues in Engineering Education and Practice*, **0**(0), 4015008.
- Svanström, M., Sjöblom, J., Segalàs, J., & Fröling, M. 2018. Improving engineering education for sustainable development using concept maps and multivariate data analysis. *Journal of cleaner production*, **198**, 530-540.
- The *Nature Sustainability* Expert Panel on 'Behavioral science for design'. 2019. Twenty Questions About Design Behavior for Sustainability, Report of the International Expert Panel on Behavioral Science for Design, New York. <https://doi.org/10.18130/v3-mqnr-xh35>
- Wang, X. H. F., Kim, T. Y., & Lee, D. R. 2016. Cognitive diversity and team creativity: Effects of team intrinsic motivation and transformational leadership. *Journal of Business Research*, **69**(9), 3231-3239.
- Watson, M.K. and Barrella, E. 2016. Using Concept Maps to Explore the Impacts of a Learning-Cycle-Based Sustainability Module Implemented in Two Institutional Contexts. *Special Issue on Sustainability Education in Civil and Environmental Engineering of Journal of Professional Issues in Engineering Education and Practice*, 10.1061/(ASCE)EI.1943-5541.0000304.
- Watson, M.K, Pelkey, J., Noyes, C. R., & Rodgers, M. O. 2016. Assessing Conceptual Knowledge Using Three Concept Map Scoring Methods. *Journal of Engineering Education*, **105**(1), 118-146.
- Whitley, C.T., Takahashi, B. Zwickle, A., Besley, J.C. & Lertpratchya, A.P. 2016. Sustainability behaviors among college students: an application of the VBN theory, *Environmental Education Research*, DOI: 10.1080/13504622.2016.1250151.

‘Storying Architecture’ Pilot Study; Trial and Tribulation. Detailing the Methodology, Implementation, and Initial Findings of a Postponed Research Project in Bali, Indonesia.

Alastair Brook

Cork Centre for Architectural Education, University College Cork & Cork Institute of Technology,
Douglas Street, Cork, Rep. of Ireland

alastair.brook.design@gmail.com

118225218@umail.ucc.ie

Abstract

This study develops upon the author’s previous paper, ‘Diversifying Epistemological Narratives in Design Discourse; Proposed Storying Methods on Place, People, and Affordances in Bali’, published in the European Society for Engineering Education (SEFI) Conference Proceedings, 2019- noted in the References section. ‘Diversifying Epistemological Narratives’ suggests that, by sharing stories together within designerly conversations, native craftspeople and architectural students could be exposed to new ancestral origins, values, and ways of knowing. These could be interpreted and integrated into the architecture of a live project, designed and built between the two stakeholder groups, in a bid to support sustainable native futures and diversify Eurocentric design education.

This paper discusses the methodology for Storying Architecture and details the tribulations of its first trial in Bali, Indonesia, including the interpretation of three emerging architectural patterns from Story ‘A’, as told by Storyteller ‘A’. Storyteller ‘A’ is one of five community members who participated in the first trial of Storying Architecture in Bali, which began the co-design process of a Learning Centre with international architecture students. Storying Architecture, as termed by the author, takes precedents from Indigenous Research and Indigenous Design Futures methodologies. Such methodologies practice indigenous stories and storytelling for educational purpose, and develop meaning and relations with new people in new spaces by acknowledging what is ‘not anymore’ and re-learning how to imagine a future that is ‘not yet’ (Archibald, 2008; Kovach, 2010; Schultz, 2018; Tuck, 2009; Davis, 2016). In doing so, such stories can provide both the impetus and the tools to move towards viable native futures (Lee, 2019; San Pedro & Windchief, 2019). This is a native paradigm of Tony Fry’s ‘sustainment’, or ‘futuring’ (2008), succinctly described by Tristan Schultz (2018).

As a research method, Storying Architecture attempts to recognise, comprehend, and interpret current and emerging architectural patterns that are hidden within each story told by a community member. These patterns are an expression of local architectural knowledge in relation to a community’s ancestry and changing local ecology- in which a community’s changing ecosystem provides context for architectural design, and architectural design provides sustainment within a community’s changing ecosystem (Alexander, 1977; 1979; Willis, 2006; Mignolo, 2011; Schultz, 2018; Escobar, 2018). Emerging architectural patterns are symptoms of adaptations and changes occurring within a community’s ecosystem, and act as warning signs for future changes (Hiltunen 2010; Holopainen & Toivonen, 2012). Members of a community can explore these emerging patterns and use them to prototype possible future architectures that benefit their community as a whole.

Over multiple phases of storying, community members have the opportunity to visualise and test a variety of emerging architectural patterns and find the ones most likely to improve their native quality of life in the future. By using playful triggers- tangible objects, art, and other mediums- the storyteller and listener, who is also the researcher, can then combine these emerging architectural patterns into a multi-modal prototype, that express their current and future desires for improving native quality of life through architecture (see Figure 1).

Each narrative study would consist of a small group of indigenous community members, the storytellers, who each hold a diverse stake in the future development of their community through architecture (Flowers et al, 2005).

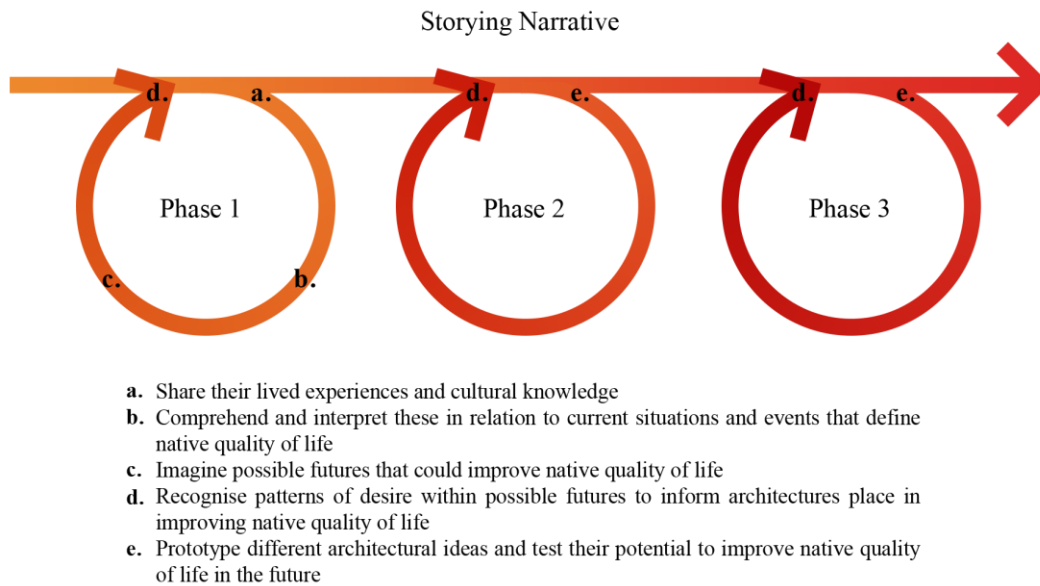

Figure 1: Storying Architecture’s Reciprocal and Cyclical Prototyping Narrative

1 Methodology

1.1 Trust Building

The extracts detailed in this paper are a representative sample from Phase 1 of the Storying Architecture pilot study conducted in Bali, November 2019. Phase 1 formulates five initial prototypes of emerging architectural patterns, one with each storyteller- see Figure 2. This is a process of reflexive interpretation between each storyteller and the listener, where the listener interprets the storyteller as the storyteller themselves interprets their own world (Smith & Osborn, 2007). Phase 1 aims to create a foundation of trust between the storytellers and the listener, who each share lived experiences and cultural knowledge through semi-structured interviews. These conversations begin telling stories that adhere to the seven principles of storying- Respect, Responsibility, Reciprocity, Reverence, Holism, Inter-relatedness, and Synergy (Shenton, 2004; San Pedro & Windchief, 2019). The listener must loosely guide each storyteller and begins to instigate architectural discussion to bring forth emerging architectural patterns. This can be achieved using methods similar to photo-voice, cultural probes, user-created personas, and yarning circles, which

continue to teach the storyteller and listener about each other. The listener may have little, to no, knowledge of the storyteller before this process begins, and learns new information from both the storyteller and from their own reflections on the storyteller- and vice versa.

1.2 Architectural Patterns

The term ‘architectural pattern’ has been taken from the work of Christopher Alexander (1977; 1979), who defines a Pattern Language for architecture as the sum total of building knowledge in an individual or group consciousness. The users of a Pattern Language can visualise and express an infinite combination of architectural patterns, which can then be applied in practice with the aim of creating buildings that feel ‘good’, ‘alive’, and improve native quality of life. Unlike Christopher Alexander’s work, this study aims to recognise hidden and emerging patterns that may establish a Pattern Language of future architecture, rather than establishing a Pattern Language of the present.

Ideally, the emerging architectural patterns would be compared and contrasted collectively by the storytellers, as the experiential experts, in a form of communal Delphi study (Husserl, 2001; Holopainen & Toivonen, 2012; Kim, et al., 2013; Leeuwen, 2005). This is achieved by using playful triggers- tangible objects, art, and other mediums- to allow the storytellers and listener to prototype the different architectural patterns that come forward (Akama & Ivanka, 2010; Sheehan, 2011; Cabrero et al, 2016, Schultz, 2018). This helps to form a non-bias consensus of the architectural patterns that are most likely to change or emerge in the future, or to most improve native quality of life in the future. Those patterns that are agreed to improve native quality of life form a multi-modal prototype, which is carried forward into the next storying phase (Leeuwen, 2005)- see Figure 2.

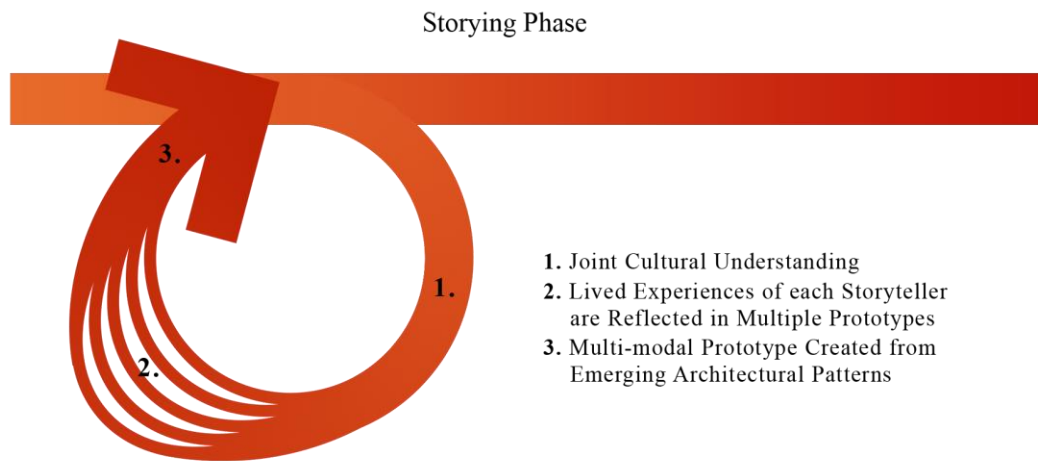

Figure 2: Multi-modal Prototype creation within each Storying Phase

1.3 Conflict Resolution

Each proceeding phase begins by geographically placing the individual storyteller within a fictional version of their communal world containing this multi-modal prototype. Each phase then ends with a communal reflection on the prototype’s impact on this fictional world. This group process does not focus on reporting each individual interpretation, as they are not readily separable from the interpretations that occur as a

community (Sim & Waterfield, 2019), but focuses instead on conflict resolution. Where conflicting patterns are interpreted between individuals, it is necessary to mediate a change in dialogue through which a solution can be found. Multi-modal prototypes can be used as mediating objects between storytellers, through which this process of dialogic change can take place (Miall, 2004; Akama and Ivanka, 2010; Schultz, 2018). Over multiple phases, it is hoped that this process will develop a prototype design that is representative of communal desires for improving their native quality of life, and move towards viable native futures. Examples from Phase 1 are shown in Section 2, taken from Story 'A', by Storyteller 'A'.

1.4 Storytellers in Context

Storyteller 'A' is a young Javanese woman who has settled in Bali. At the time of data collection, she held a leadership role within a Balinese community development organisation, which planned to run and administrate the Learning Centre after construction. For ethical purposes, all other personal details of Storyteller 'A' are anonymised. The other storyteller's, who do not appear in this paper, are all of Indonesian descent and include; an ex-employee of the community development organisation, the architect of an affiliated organisation, the community leader of a partnered NGO organisation, and the founder of an architecture collective. The Learning Centre was planned as an educational space to be used by the local Community Development organisation, for the purpose of teaching entrepreneurial skills to Balinese youth between the ages of 12-25. These skills classes aim to encourage youth to stay in rural areas and establish occupations in 'sustainable tourism', in the hope of stemming mass urbanisation and 'unsustainable tourism' that is eroding local Balinese culture and causing major economic issues in rural regions (Yu, 2015). The design and construction of the Learning Centre was intended to be facilitated by an Irish Social Enterprise, co-founded by myself.

Since the collection of this data occurred, the Learning Centre project has been placed on hold. This is partly due to the nature of working with NGO organisations in a volatile geo-politic situation, who have struggled to maintain resources such as staff, regional offices, and customers during changing social and economic climates. This has caused issues of re-location, changes in building site, closure of youth education programmes, and limited local community members to administrate the Learning Centre. This has also impacted the data collection process, which was indefinitely suspended part way through the pilot trial of Storying Architecture, meaning that Phase 1 was not fully completed.

1.5 Trial in Practice

The data that has been collected and analysed will still be shared, in all transparency, as each story represents a piece of the storytellers identity that is a legitimate source of knowledge production (San Pedro & Windchief, 2019; Smith, 2003). In doing so, I treat the storyteller as the experiential expert (Husserl, 2001), and give preference to their direct extracts and interpretation of their own world over my own. Each storyteller was asked, through semi-structured interviews and cultural probes, to explain their reasons for engaging in the Learning Centre project, and to speculate on the vocational, cultural, societal, and place bound implications of the proposed Learning Centre. Each participant in the study was also asked to photograph tools or other items which they used in their daily craft, and to plot where they learnt this knowledge using a Polarity Map.

The data was analysed using an Interpretative Phenomenological approach, in which the transcripts were coded multiple times to capture, understand, and do justice to the meanings of the storytellers. Throughout

this coding, categories of motivation were interpreted by myself; Personal (Familial and Individual), Communal (Societal, Cultural, and Religious), Vocational (Educational and Occupational), Geographical (Location and Place Bound), and Architectural (Affordances Offered, Spatial Use, Design and Craft Influences). In future data collection trials, my interpretations of the data will also be subjected to a critique by peer review, participant verification, and analysed by external voices who have experience similar situations.

Section 2 narrates extracts of Story ‘A’ in which the storyteller interprets their own world, followed by my analysis and interpretation of their interpretation. This double hermeneutic approach outlines potential emerging architectural patterns for the planned Learning Centre in relation to its impact on native quality of life. In this process, the listener must analyse any assumptions made by the storyteller, assessing their accuracy, and comparing them to other primary and secondary data. However, the storyteller’s own experience and interpretations take precedent in bringing forth emerging architectural patterns. Unless significant data is found to the contrary, these emerging patterns could be considered by the community as part of a multi-modal prototype.

2 Data Analysis- Extracts from Story ‘A’

Story ‘A’ was told during a traditional Balinese lunch served in the office of Storyteller ‘A’ and lasted 32 minutes and 25 seconds. Each of the following three sub-sections begins with extracts containing quotes grouped together in themes denoted by each sub-section. Each quote is labelled in chronological order as they appear in the original story, as quotes on similar themes do not always appear together. This labelling serves to preserve the meaning of the storyteller and provide transparency for the reader. A label appears as (P1:S1), where ‘P’ represents a paragraph, and ‘S’ represents the sentence number within that paragraph. This is followed by an analysis of each extract, and an interpretation in relation to the Learning Centres requirements. This analysis draws from the quoted text, literary citations, and my own personal knowledge of the storyteller and their community, which was gained over a two-year period of discussions and visits between myself, the participating storytellers, and other community members in Bali.

2.1 Peer-to-Peer Engagement on Cultural Taboos and Stigma

“Yeah, so the reason that I also like Bali is because, with all these modernisations, and people coming from everywhere, they still stick to their culture- that’s what I like... and the freedom, I think, it is different than any other cities in Indonesia... (P4:S1) That is why I love the Local Women’s Centre especially, and then when I visited again a couple of days ago, she wanted to build a Men’s Centre. And it is like, ‘Okay, now you are also aware that it is not just about feminist issues, but right now men also have some issues’ (P7:S1). But, the thing is, the people in West Bali, let’s say, they are villagers. They have a different mindset than the people who already live in the city. So, sometimes, it is hard to develop them, to ask them to move forward with us. But, if there is change coming to them, we need to work hard to show them that it is okay, that it can be for their own good. So, I think, with the Learning Centre, the community there would benefit from it a lot, but there is going to be a challenge to ask them to join us (P21:S1).”

Quote P4:S1 expresses the freedom that Storyteller ‘A’ feels within the changing urban fabric of Denpasar, Bali’s capital city, which has seen its popular culture and education drastically shaped by capitalist

modernity (Jensen & Suryani, 1992; Lansing, 1995; Hobart et al., 1996; Pringle, 2004; Yu, 2015). Such a transformation causes problems of population resettlement in both urban and rural areas, that threatens to erode centuries-old cultural traditions (Terminski, 2015; Yu, 2015). However, the storyteller recognises that Bali is, as Hobart et al. (1996, p.226) described, “a society that is continually seeking its own identity within changing frames of reference”, whose people still manage to preserve their cultural beliefs and values through music, dance, rituals, and religious practices (Yu, 2015). This expresses personal, communal, and geographical motivations for the Learning Centre to question and reflexively adapt values of Balinese tradition and modernity.

Quote P7:S1 discusses the subversion of traditional Balinese culture and society, which has been described as a patriarchal system that traditionally relegates men into positions of power and women into positions of subservience to men (Yu, 2015). The leader of the Women’s Centre, described in this quotation, is depicted as an individual who strives to create mutual support within a community through the sharing of experiences, peer-to-peer support, and self-empowerment (Yu, 2015). This sharing process is informed by Balinese sociocultural value, rather than western modernity, and expresses strong communal motivations for the Learning Centre to be a space of experience sharing- where community members can question and reflexively adapt to traditional taboos and issues of modernity.

Within quote P21:S1, the storyteller comments on the social, financial, and educational pressures of villagers to compete with other villagers/ villages with other villages, which has impacted rural communities’ abilities to maintain social cohesion and identity amidst quickly changing social values (Parker, 2011; Yu, 2015). This contrasts with urban and tourism areas, such as Denpasar and Ubud, where mass development has enticed Balinese youth to migrate for work and education, boosting economic and academic growth (Parker, 2011; Terminski, 2015). This describes cultural influences, based on tradition vs modernisation, for the Learning Centre to invest in rural areas and help heal social, financial, and educational wounds. This is based on the storyteller’s positive opinion of urban Bali, and their desire to bring rural areas ‘forward’ with urban areas.

The storyteller comments often on various power dynamics within current Balinese society, some of which stem from the discord between Balinese tradition and imposed Western modernity. These power dynamics include social, financial, and educational divides between rural/urban, youth/non-youth, Balinese/non-Balinese and male/female. The storyteller suggests that a space for peer-to-peer engagement and reflexive questioning of these taboo and stigmatised dynamics will lessen the divide between geographical, age, national, and gender demographics.

Emerging architectural patterns interpreted from this extract may include, but are not limited or bound to:

- Being large enough to hold a small group of people, i.e. 5 persons, but not too large as to hold more than a classroom full, i.e. 20 persons- for privacy when discussing personal issues.
- Being an open plan space with multiple entries and exits to allow freedom of movement throughout the building’s fabric- for security and wellbeing.
- Having tools for self-reflection through Balinese socio-cultural means i.e. meditation space with correct resources and orientation, etc., and adopted means i.e. selected western academic teachings with applicable resources- for sharing experiences and understanding the self in relation to the wider world.

- Having a community hall and means of summoning the community together (such as kulkul drum) to communicate on important issues such as social, financial, and educational matters- for maintaining social cohesion and identity without conflict.

2.2 *Local Leadership for Contextual Knowledge Sharing*

“Maybe you need to find a place where the Learning Centre is close to nature, right? So you can also have the tracking and camping and stuff like that. Because, what I believe is that humans just connect with nature, and the more you play in nature the more you get experiences, the more you get lessons, the more you get anything- basically nature is the best tool of all time (P12:S2). Especially if it is very sustainable, so they can experience it themselves and if they can have full appreciation of the nature so that they can take care of it (P14:S1) And maybe we give them some training. Let’s say we can give a programme to the farmers- right now most of the farmers are using pesticide and we actually have some of our partners that are willing to go back to an organic way and they can come to the Learning Centre and share how he is doing it to the other farmers. It could also benefit the local community, in terms of financial things, so if they can also work at the Learning Centre and are participating in our trips or our programmes, let’s say we are going to have facilitators from Balinese people, that could give them benefits too (P16:S1). I think you need Balinese people at least to be their leader so that they can also share the knowledge and everything... and, somehow, I think they are going to listen more to local people instead of outside people (P18:S1).”

In quote P12:S2, the storyteller outlines their personal connection to the Indonesian, and more specifically Balinese, values of harmonisation between individual, nature and community (Yu, 2015). This harmonisation is part of the Tri Hita Karana philosophy, in which God, Human and Nature coexist in peaceful harmony and can be seen as a product of Hindu, Buddhist, and ancient Malayo-Polynesian beliefs found in Balinese religion (Peters & Wardana, 2013; Lansing, 1995). The storyteller depicts cultural and personal motivations through a vocational lens, suggesting that nature be used as a tool to add greater benefit to community members and international visitors to the Learning Centre space.

Quote P14:S1 depicts a self-sustaining cycle influenced by the Balinese beliefs of harmonisation with nature- where communities take care of their immediate environment which, in turn, takes care of them. This describes the ontological loop of design, where communities practice the design of themselves (Willis, 2006; Escobar, 2018). This expresses culturally driven motivations for the Learning Centre to be a vehicle for communal self-design- an example of which is provided by the storyteller in quote P16:S1.

Storyteller ‘A’ describes an example of communal self-design within quote P16:S1 (see also P14:S1) through agriculture, the historical industry of Bali. However, since the 1940’s, tourism and its related industries have displaced agriculture as Bali’s leading sector, Balinese farmers have been encouraged to relocate to less populated islands, and the continued use of traditional farming techniques, with no machines or pesticides, has all but disappeared (Picard, 1997; Yu, 2015). This has had serious impacts on the Balinese social and cultural system in rural areas as communities catered to visiting tourists over agricultural land (Romanos & Dudley Jenkins, 2013). The storyteller draws upon communal, traditional, and vocational motivations to suggest how the Learning Centre space could be used by local farmers to re-educate each other in traditional and organic agricultural methods- a method of social and cultural transformation.

Quote P18:S1 leads on from quote P16:S1, to narrate a situation in which Balinese leaders have, and can continue to, intervene in local social and cultural systems by developing creative practices in their line of work or developing creative spaces for community transformation (Yu, 2015). This depicts cultural, communal, and vocational motivations for Balinese leaders to organise and administrate the activities of the Learning Centre space.

The storyteller comments on the self-sustainability of Balinese social and cultural systems, emphasising the need for peer-to-peer, Balinese-led, education that encourages creative practices for transformation. The impact of Western Modernity is an underlying topic within the storyteller's narrative, providing commentary on the impacts of unsustainable tourism. The storyteller suggests the Learning Centre could provide a creative space for communities to engage in communal self-design.

Emerging architectural patterns interpreted from this extract may include, but are not limited or bound to:

- Providing physical connections to nature by being situated in or close to it- to signify social and cultural meaning, and form an educational and touristic space for visiting guests.
- Being next to arable land and have accessible agricultural tools, which can be used to teach sustainable agriculture techniques- an act of self-design, in which the community learns and practices self-sustaining principles.
- Having resources and tools to become a creative space within a field of industry, i.e. textiles and sewing tools, etc.- as a means of social and economic transformation.

2.3 Creating New Opportunities for Youth in Rural Areas

“Our organisation wants to be one of the solutions for mass tourism and stop the youth coming to the city (P5:S1). Maybe they can also learn how to build another design, learn how to design a sustainable building or something (P17:S1). What I am thinking about is that it will actually benefit the young people who are involved in this Learning Centre building, because it will also help them get a job, give them something to do, give them financial help (P19:S1).”

Quote P5:S1 emphasises the importance of the Learning Centre to stem the urbanisation of rural Balinese youth, incentivising them to stay in rural areas for economic benefit. The development of tourism has drained the villages of young people who move to the cities for work, and has forced rural land to be taken away from the people who sustain themselves on it (Yu, 2015; Terminski, 2015). This process further incentivises urbanisation, impacting the economic, cultural, and social systems of rural communities, leaving them vulnerable (Terminski, 2015; Patel, et al., 2017). This suggests strong cultural, communal, and vocational motivations for rural Balinese youth to learn from the design and construction of the Learning Centre, providing economic prospects in rural areas whilst strengthening their cultural social systems.

In quote P17:S1, the storyteller expresses the concept of ‘knowing by doing’, where knowledge is shared through the practical act of doing, and is expressed as a practiced and exercised skill that is developed over time (Fry, 1994; Heidegger, 1962). The storyteller suggests that, by designing and building the Learning Centre, local community members will gain knowledge and skills to build similar, socially sustainable buildings. This shows communal and vocational motivations to educate community members and grow a stronger and more sustainable local community.

Quote P19:S1 continues to develop upon quote P17:S1, describing how the new knowledge and skills learnt by constructing the Learning Centre could translate into economical opportunities for young people in the rural areas of Bali. This shows communal and vocational motivations for local community members to engage with the Learning Centre before, during, and after construction.

The storyteller emphasises strong economic motivations for youth involvement in the Learning Centre construction. The reasoning behind these economic motivations stem from ongoing power dynamics within Balinese cultural and social systems, between traditional heritage/western modernity, rural/urban, youth/non-youth. The storyteller suggests that the educational impact of the Learning Centre design and construction may contribute to new economic opportunities for youth in rural areas.

Emerging architectural patterns interpreted from this extract may include, but are not limited or bound to:

- Having rural youth as members of the construction team- creates employment opportunities for rural youth during the construction process.
- Using sustainable construction techniques, i.e. use local materials such as pine and bamboo, etc. that are easily transferable to other building projects- providing a new construction model that can be copied and implemented in other sustainable buildings.
- Demonstrating sustainable construction principles in the finished building i.e. using tectonic architecture etc., and have the space, resources, and tools to host classes and workshops that teach these construction principles- to increase skilled local craftsmen who can boost the economy through future builds.

3 Concluding Statements

Storyteller 'A' narrates the first emerging architectural patterns, as interpreted by the author, within the pilot study of Storying Architecture- see Section 2. These interpretations depict emerging architectural patterns that aim to improve native quality of life by:

- Providing open plan spaces with freedom of movement between multiple places of reflection; reflection as a larger community on societal and economic issues including taboos and conflicts, reflection as smaller groups in guided discussions and activities on personal issues, or self-reflective activities as individuals such as meditation.
- Being close to, or within, natural surroundings that are maintained by the community- whether this is for agricultural/vocational reasons or spiritual reasons- in a process of self-sustainment.
- Providing space, resources, and tools for both academic and practical education in the community, on a variety of skills that could transform local societies and economies, i.e. sustainable agriculture, sustainable building construction, industry specific skills such as textiles manufacturing, or managing tourism trips and programs for visitors.

Whilst Storying Architecture attempts to encourage diversity within architectural conversation, the author recognises the heavy biases placed upon his own interpretations of the story due to the incomplete trial- see Section 1.4. Future studies of Storying Architecture will endeavour to place a stronger emphasis on storyteller led interpretations through visual and tactile means, as outlined in Sections 1.2, 1.3, and 1.5. These future studies will also endeavour to include emergency measures in case of changes in local geo-political, social, or economic situations, such as; virtual or remote data collection methods, means to

sustainably postponed projects until a later time of completion, or support structures in place to see projects through to some level of completion in a specified timeframe.

References

- Akama, Y., & Ivanka, T. (2010). What Community? Facilitating Awareness of Community Through Playful Triggers. In: K. Bodkier; T. Bratteteig; D. Loi; T. Robertson (eds.), *Participation, The Challenge*. New York: ACM, pp. 11-20.
- Alexander, C. (1977). *A Pattern Language: Towns, Building, Construction*. New York: Oxford University Press.
- Alexander, C. (1979). *The Timeless Way of Building*. New York: Oxford University Press.
- Archibald, J. (2008). *Indigenous Storywork: Educating the Heart, Mind, Body, and Spirit*. UBC Press, Vancouver.
- Brook, A. (2019). Diversifying Epistemological Narratives in Design Discourse; Proposed Storying Methods on Place, People, and Affordances in Bali. In Kálmán, A., Järvinen, H., Murphy, M., & Nagy, B. (Eds). *Varietas delectat... Complexity is the new normality Proceedings SEFI 2019*. (pp. 164-175) Budapest: University of Technology and Economics.
- Cabrero, D., Gerardo, C., Álvarez, P., & Abdelnour-nocera, J. (2016). User-Created Personas in rural Mexico and in rural Spain : Approaches neither from the North nor from the South. *Avances en Interacción Humano-Computadora*, [S.l.], 1, pp.13-17.
- Chapman, J. (2005). *Emotionally Durable Design: Objects, Experiences & Empathy*. London: Earthscan.
- Davis, A. (2016). *Freedom is a constant struggle: Ferguson, Palestine, and the foundations of a movement*. Chicago: Haymarket Books.
- Escobar, A. (2018). *Design for the Pluriverse*, Durham, Duke University Press.
- Flowers, P., Larkin, M., & Reid, K. (2005) Exploring lived experience: An introduction to Interpretative Phenomenological Analysis. *The Psychologist*, 18:1, 20-23.
- Fry, T. (1994). Green Hands Against Dead Knowledge. In *Remakings: Ecology, Design, Philosophy*. Envirobook, Sydney, pp. 87–102.
- Fry, T. (2008). *Design Futuring: Sustainability, Ethics, and New Practice*. Oxford, Berg Publishers.
- Heidegger, M. (1962), *Being and Time*, Translated by: Macquarrie, J., and Robinson, E., Oxford: Blackwell.
- Hiltunen, E. (2010). *Weak Signals in Organizational Futures Learning*. Aalto: Aalto University School of Economics.
- Hobart, A., Ramseyer, U., & Leemann, A. (1996). *The peoples of Bali*. Oxford: Blackwell.
- Holopainen, M., & Toivonen, M. (2012). Weak Signals: Ansoff Today. *Futures*; 44(3), pp. 198-205.
- Husserl, E. (2001). *Logical Investigations*. Oxon: Routledge.
- Jensen, G. D., & Suryani, L. K. (1992). *The Balinese people: A reinvestigation of character*. Singapore: Oxford University Press.

- Kim, S. et al., (2013). NEST: A Quantitative Model for Detecting Emerging Trends Using a Global Monitoring Expert Network and Bayesian Network. *Futures*; 52, pp. 59-73.
- Kovach, M. (2010). Conversation Method in Indigenous Research. *First Peoples Child & Family Review*, 5(1), pp. 40-48.
- Lansing, J. S. (1995). *The Balinese*. Fort Worth, TX: Harcourt Brace College Publishers. Pringle, R. (2004). *Bali: Indonesia's Hindu realm*. Crows Nest: Allen & Unwin.
- Lee, T. et al. (2019). 'K'E and Tdayp-Tday-Gaw. Embodying Indigenous Relationality in Research Methods' in San Pedro, T. & Windchief, S. Eds. *Applying Indigenous Research Methods: Storying with Peoples and Communities*. (p.46) New York, Routledge.
- Leeuwen, T. (2005). *Introducing Social Semiotics*. Oxon: Routledge.
- Miall, H. (2004). *Conflict Transformation: A Multi-Dimensional Task*. Berghof: Berghof Research Center for Constructive Conflict Management.
- Mignolo, W. (2011), Geopolitics of Sensing and Knowing: On (De)coloniality, Border Thinking and Epistemic Disobedience, *Postcolonial Studies*, 14(3), pp. 273-283.
- Mugge, R. (2008), *Emotional Bonding With Products: Investigating Product Attachment From A Design Perspective*. Saarbrücken: VDM Verlag Dr. Müller.
- Parker, G. (2005). Living in two worlds: How tourism has influenced the Balinese worldview of Tri Hita Karana (Master's thesis). Retrieved February 8th, 2020, from https://mro.massey.ac.nz/bitstream/handle/10179/3175/02_whole.pdf.
- Patel, R.B., King, J., Phelps, L. and Sanderson, D. (2017). What practices are used to identify and prioritize vulnerable populations affected by urban humanitarian emergencies? *A Systematic Review. Humanitarian Evidence Programme*. Oxford: Oxfam GB.
- Peters, J. H., & Wardana, W. (2013). *Tri hita karana: The spirit of Bali*. Jakarta: Kepustakaan Populer Gramedia.
- Picard, M. (1997). Cultural tourism, nation-building, and regional culture: The making of a Balinese Identity. In M. Picard & R.E. Wood (Eds.), *Tourism, ethnicity, and the state in Asian and Pacific societies* (pp.181-214). Honolulu, Hawaii: University of Hawai'i Press.
- Pringle, R. (2004). *Bali: Indonesia's Hindu realm*. Crows Nest: Allen & Unwin.
- Romanos, M., & Dudley Jenkins, L. (2013). Changing cultural developments along a tourist route in Bali. *Almatourism - Journal of Tourism, Culture and Territorial Development*, 4, 8, 19-31.
- San Pedro, T. & Windchief, S. (Eds). (2019). *Applying Indigenous Research Methods: Storying with Peoples and Communities*. New York, Routledge.
- Schultz, T. (2018). Mapping Indigenous Futures: Decolonising Techno-Colonising Designs, *Strategic Design Research Journal*, Vol.11, No.2, pp. 79-91
- Sheehan, N. (2011). Indigenous Knowledge and Respectful Design: An Evidence-Based Approach. *Design Issues*, 27, pp. 68-80.

- Shenton, A. (2004). Strategies for Ensuring Trustworthiness in Qualitative Research Projects. *Education for Information*; 22, pp.63–75.
- Sim, J. & Waterfield, J. (2019) Focus Group Methodology: Some Ethical Challenges. *Qual Quant*. 53, pp. 3003–3022
- Shepherd, R. (2002). Commodification, culture and tourism. *Tourist Studies*, 2, 2, 183-201.
- Smith, J. (Ed). (2003). *Qualitative psychology: A practical guide to research methods* (pp. 235-251). London: Sage
- Smith, J., Osborn M. (2007). Pain as an Assault on The Self: An Interpretative Phenomenological Analysis. *Psychology and Health*; 22, pp. 517–534.
- Smith, J., & Osborn, M. (2015). Interpretative phenomenological analysis as a useful methodology for research on the lived experience of pain. *British journal of pain*, 9(1), 41–42.
- Terminski, B. (2015). *Development-Induced Displacement and Resettlement*. Stuttgart: Ibedum.
- Tuck, E. (2009). Suspending Damage: A Letter to Communities. *Harvard Educational Review*, 79(3), pp. 409-428.
- Willis, A. (2006). Ontological Designing, *Design Philosophy Papers*, Vol.4, No.2, pp.69-92
- Yu, A. (2015). On Moral Imagination and Indigenous Wisdom: How Leaders Approach Moral-Ethical Tension in Post-Modern Bali, PhD in Leadership and Educational Science, University of San Diego, San Diego.

Innovation Clubs: Mobilizing Local Creativity for Sustainable Development and Pedagogy

Christianos A.G. Burlotos¹, Tracy L. Kijewski-Correa^{1,2}, Lamarre Presuma³, Alexandros A. Taflanidis¹,
and William L. Cunningham⁴

¹Department of Civil and Environmental Engineering and Earth Sciences, University of Notre Dame,
United States of America

cburloto@nd.edu

²Keough School of Global Affairs, University of Notre Dame, United States of America

³Engineering to Empower, Léogâne, Haiti

⁴Department of Aerospace and Mechanical Engineering, University of Notre Dame, United States of
America

Abstract

Two months after the 2010 Haiti earthquake devastated Port-au-Prince, a reconnaissance team of structural engineering researchers from the University of Notre Dame travelled to Léogâne to assess the damage. As their research revealed the underlying problems plaguing the residential construction industry in Léogâne, they realized that recommending externally-devised engineering solutions alone would not bring about significant change. In order to discover more holistic and implementable solutions, they turned to the affected community. By hosting open innovation challenges throughout Léogâne, the research team identified local innovators who demonstrated leadership, problem-solving skills, and creativity. These local innovators, forty-two men and women of various professions representing each of the six zones of Léogâne, were then trained and certified in the *Pwosesis pou Innovasyon* (Innovation Process) - a Creole-adapted form of Human-Centered Design. These individuals subsequently engaged their neighbors to form six Innovation Clubs. For seven years, undergraduate and graduate engineering students have worked with these Innovation Clubs to facilitate sustainable development research initiatives. This paper describes the framework used to establish these Innovation Clubs, case studies of cooperative projects, the observed benefits of this collaboration, and recommendations for future implementation.

1 Introduction

Just over ten years ago, a magnitude 7.0 earthquake devastated Port-au-Prince, Haiti, killing 230,000 people and leaving another 1.2 million homeless (Margesson & Taft-Morales, 2010). In Léogâne, a city of 90,000 people near the earthquake's epicenter, 93% of buildings collapsed or were damaged (Eberhard *et al.*, 2010). Two months after the earthquake, a reconnaissance team of structural engineering researchers from the University of Notre Dame travelled to Léogâne to assess the damage (Mix *et al.*, 2011). Upon returning, they established the organization Engineering to Empower (E2E) with the goal of developing new approaches to the Haitian housing crisis. Embracing methods of participatory design, the researchers sought to identify community members to engage in their design process. By hosting open innovation challenges

in each of Léogâne's six zones, the research team identified local innovators who demonstrated leadership, problem-solving skills, and creativity in one of three activities. These local innovators, forty-two men and women of various professions representing each of the six zones, were then trained and certified in the *Pwosesis pou Innovasyon* (Innovation Process) - a Creole-adapted form of Human-Centered Design. These individuals subsequently engaged their neighbors to form six Innovation Clubs, each tied to a zone of the community.

Participatory design can be summarized as stakeholder participation and citizen involvement in the conceptualization and design of engineering projects (Sheller *et al.*, 2013). By involving the end users throughout the design process, one increases the chances that such efforts are aligned with local needs and capacities (Daniell *et al.*, 2010). Although the importance of stakeholder participation in such work is widely recognized (Barreteau *et al.*, 2010; Daniell *et al.*, 2010), available methods of achieving such participation, particularly within the pressures of post-disaster contexts, are limited (Sheller *et al.*, 2013). In this paper, we offer a structured methodology for operationalizing participatory design principles in engineering projects in low-income countries.

Since their formation, these Innovation Clubs ("the Clubs") have worked alongside engineering faculty and students on a variety of sustainable development-related research initiatives. Such engagement in interdisciplinary, project-based roles is critical to preparing engineering students for sustainable development (Lehmann *et al.*, 2008). While some of this work has been previously published or presented academically (Kijewski-Correa *et al.*, 2012; Presuma & Jean, 2014), this paper will focus on recent projects where engineering students were the primary US-based driver of these collaborations. Subsequent sections of the paper overview the selection and training process used to form the Clubs, followed by case study projects led by cross-national teams of US students and Haitian club members. The paper closes with a reflection on the observed benefits for the involved stakeholders, as well as recommendations based on lessons learned throughout the process.

2 Member Selection and Training

To find innovators in the community, the researchers hosted open innovation challenges in each of Léogâne's six zones. Residents of the zones were invited to respond to an open-ended challenge that was publically scored to demonstrate their leadership, problem-solving skills, and creativity in one of three activities described below.

- **Creative Construction:** Participants were asked to design and construct a bench that could support two adults. Each participant was given a specific set of materials (see Figure 1) and a half-day to build their bench. The finished products were judged by community members based on function, cost, and aesthetics.
- **Persuasive Speech:** Participants were asked to give a three-minute persuasive speech showcasing their vision to reduce the amount of garbage in Léogâne's streets and waterways. Speeches were judged by a panel of three local judges based on persuasiveness, feasibility, and popularity.
- **Efficient Production:** Participants received a toy car kit and were asked to develop a production strategy for quickly assembling the car while assuring its quality. They then recruited and trained a production team of three individuals according to this strategy. These production teams were then tasked with building five kits as fast as possible. Participants were scored based on the efficiency of their strategy as well as the quality and consistency of the cars.

These screening challenges were designed to find community members with specific skills that would best align with the needs of the researchers' team at that time, respectively identifying individuals who could fabricate innovative building envelope systems, effectively inspire collective action, and develop quality control processes to regulate construction. The scores of all participants were displayed publically, with those earning the highest scores in each zone invited to receive training in the *Pwosesis pou Innovasyon* (Innovation Process). Those that were not selected were later encouraged to get involved with the Clubs.



Figure 1: The materials available (left) for the bench challenge and the winning design (right).

The *Pwosesis pou Innovasyon* was a Creole-adaptation of the Human-Centered Design (HCD) process outlined in IDEO's Human-Centered Design Toolkit and Field Guide (IDEO, 2009; IDEO, 2015). Using a highly visual workbook and template sheets to organize the outcomes of various stages of the process, the trainees were introduced to techniques to elicit information from end users, sort learnings to generate insights, brainstorm potential solutions, construct "How Might We...?" questions, and rapidly prototype solutions using physical models, role playing and storyboards. The five-day experiential training encouraged the local innovators to form teams that would examine one of three questions: 1) How might we use a savings program to prepare aspiring homeowners for a mortgage? 2) How might we encourage high quality construction practices in the residential sector? and 3) How might we create culturally appropriate finishes for post-quake housing? On the final day, each team presented its prototype to the workshop attendees and received a certificate of completion. Ultimately, forty-two men and women in various professions across the different zones of Léogâne were trained in the *Pwosesis pou Innovasyon*.

Following this training, the forty-two participants returned to their zones and began sharing the outcomes of this experience. Participants reported the continued use of the skillsets developed in the workshop and eventual training of other zone-members in the *Pwosesis pou Innovasyon*. With growing interest and application of this process to address locally-sourced challenges, the researchers worked with the growing cohort of local innovators (100+ people) to form approximately a dozen teams that were eventually consolidated into six Innovation Clubs (see Table 1), each tied to a zone within the community.

Table 1: Demographics of Léogâne-based Innovation Clubs, as of February 2020.

Zone of Léogâne	Number of Women	Number of Men	Mean Age	Age Range
Dufort	11	8	23.6	14-39
Belval	6	12	30.2	22-43
Bino/Bwalam/Ça Ira	22	4	31.8	17-54
Chatuley/Nan Jaden	7	7	30.1	24-39
Corrail/Barriere Rouge	9	7	32.0	16-59
Rue Poudriere	1	10	32.2	19-55

3 Student-Club Collaborations

For seven years, undergraduate and graduate engineering students have worked with these Innovation Clubs to facilitate sustainable development research initiatives in Léogâne, expanding beyond housing to explore community-sourced issues such as financial literacy, sanitation, and drinking water access. The Innovation Clubs significantly bolster the capacity for data gathering in Léogâne throughout the school year, particularly when students cannot travel to Haiti, while ensuring that a wide range of local perspectives are considered. This section provides two case studies of the fieldwork leveraging student-club collaborations.

3.1 Field Work: A Case Study in Financial Literacy

Weak financial institutions, inflation, and frail legal systems have inhibited the maturation of mortgage markets in developing nations (Sanders, 2005). Thus, families must build homes incrementally, buying materials and building as their income allows. The family remains exposed both throughout this decade-plus process and after, as the high variability in materials and workmanship render an incrementally-constructed home highly vulnerable to natural hazards (Mix *et al.*, 2011). For the past five years, students have been involved in an ongoing process to research alternative housing finance solutions to unlock safe construction for those in the middle and lower socioeconomic classes in Léogâne.

In January 2017, two undergraduate students traveled to Haiti for an in-person collaboration on this topic. Each day, a different group of six Innovation Club members came to the Club's office in downtown Léogâne to participate in participatory activities designed to invoke insightful conversation and creative problem-solving. For example, in the Expense Prioritization Activity, participants ranking of 10 common expenditures by importance was used to drive discussion of financial priorities (see Figure 2). In another activity, small teams used live skits to demonstrate how to discourage friends from depleting their savings accounts.

Other activities were more focused on basic accounting skills, such as the Sample Income and Expense Tracking Activity, which provided a fictional narrative that participants then distilled into a record of income and expenses to establish basic concepts in financial literacy. This then enabled participants to complete a Personal Financial Assessment inventorying personal income, expenses, savings, receivables, and debts. As the first full glimpse into their own financial situation, participants requested that these worksheets be modified to form the basis of a finance tracking workbook to help displaced families increase their rate of savings toward a new home.



Figure 2: An undergraduate student and staffer lead the Expense Prioritization Activity.

This week-long engagement and the subsequent remote collaboration that followed has formed the basis for ongoing collaboration between the students and Clubs on alternative housing finance programs in Léogâne. Importantly, the personal networks of the Clubs enable access to different market segments of the community, ensuring that unique perspectives are included in the program design, e.g., isolating the needs of those without land tenure and exploring the potential to connect them to community members interested in developing their larger plots of land into individual parcels.

3.2 Field Work: A Case Study in Drinking Water Access

In 2018, another group of undergraduate students partnered with the Clubs to examine how to expand access to safe drinking water in Léogâne. In addition to facilitating focus groups and brainstorming sessions in the Léogâne office, the Clubs further mobilized a systematic data collection campaign to identify the point in the drinking water supply chain where contamination is likely to occur. The student team discretized the drinking water supply chain into five phases: Source, Transportation, Treatment, Storage, and Use. To facilitate observational research across households in the community, the student researchers designed and encoded a data collection survey in Fulcrum, a mobile surveying application that also collects geocoded photos and videos. Twelve club members used this custom app to each document two community members' interactions with the drinking water supply chain and explore various pain points in the process. The detailed accounts, photos, and videos acquired provided valuable insights into daily life in Léogâne and helped the student team deepen their empathy with the targeted end users. It is important to note that the design of the survey and collection of visual media eliminated the need for translation and allowed student researchers to directly access technical information that is difficult to specify in conversation, such as the type of containers or the process for treating water. Unsurprisingly, this media-based approach further revealed unexpected insights and details the students had not considered, such as the particularities of a cooking setup or the type of covering (or lack thereof) on a well.

Despite the value of the methodology and technology, the success of this activity was made possible by the level of access afforded by the use of the Clubs. As citizens of Léogâne, known and trusted by many in their community, they are able to gather higher-quality data and more candid insights than foreign

researchers. These relationships allow them to negotiate access to private areas such as kitchens (see Figure 3) to observe intimate activities such as food preparation that can reveal the opportunities to reduce contamination.



Figure 3: Imagery collected by Innovation Club members: creative transport of drinking water (left) and use of collected water in food preparation tasks (right).

3.3 Remote Collaboration

Once projects and relationships are established between students and the Innovation Clubs through field work, this work can continue remotely throughout the academic year at times when travel would otherwise be infeasible. This is particularly critical when working in countries like Haiti, where travel restrictions frequently prohibit university-sponsored trips. Students remotely design work packets leveraging focus groups, mobile surveys and other participatory activities, which local staff translate and facilitate, engaging various techniques to capture and transmit the generated data. One example is a housing finance activity in which Innovation Club members were provided with a general framework for a community housing fund and were asked to meet over a series of weeks to detail the framework's implementation within the local context. Another example is the Club-appointed "Water Committee," which assists researchers with brainstorming, concept validation, and market analysis of new interventions to improve access to clean drinking water. While these remote collaborations often move at a slower pace than in-person field work and require care in the design and documentation to ensure clear communication, these modalities facilitate continual engagement of the Innovation Clubs by US-based teams who are required to be on campus throughout the academic year.

4 Observed Benefits

Beyond the data and unique insights generated, collaborating with local Innovation Clubs continuously challenges students and most notably helps develop improved communication and problem definition skills. In order to effectively communicate their ideas across language and cultural barriers, students must distill

their ideas concisely without technical jargon. These constraints often challenge students' creativity and visual communication skills, but are invaluable in preparing students for work in low-income countries or with other non-English speaking or low-literacy populations.

Additionally, these engagements are often among the students' first experiences in open-ended problem solving. While the ambiguity can be unsettling, it forces students to ask the right questions, consider the context, and formulate their own strategy to address the problem at hand. While Club members identify broad areas for potential innovation (e.g., "Dirty water makes people sick") and bring a wealth of local knowledge about such topics, students are central in directing the process toward a viable outcome. This promotes creativity and proactivity as students design and execute their own lines of inquiry.

In addition to benefiting the students and the project outcomes, this collaboration has tangible benefits on the club members themselves. Community members are not only key interlocutors and data collectors, but co-designers of potential solutions to a problem they have collectively identified. The Clubs create a platform and venue for engagement around community issues, while building essential skillsets in collaborative problem solving, teamwork, and Human-Centered Design. Club members note that the product management and research techniques introduced in these collaborations model new modes of work that in turn benefit them in other dimensions of their personal and professional lives. Ultimately, this facilitates the localization of development projects by not only valuing local perspectives and preferences, but also inviting co-design at every step of the process.

5 Conclusion and Recommendations

Overall, the formation of Innovation Clubs in Léogâne has contributed to training student researchers, conceiving innovative research projects, and encouraging co-design with local populations. This paper outlined the Club formation process, case studies of collaborative projects, and observed benefits. These in turn inspire the following recommendations for future implementations of this process:

Logistics: Language skills are often the limiting factor in the research process, especially when working in the field. Thus, encouraging language learning among students, hiring multiple translators, and designing activities to minimize reliance on open-ended verbal communication will improve implementation. Likewise, travel restrictions can disrupt progress, thus establishing the necessary local infrastructure (including personnel, workspaces, technology, etc.) is critical to maintaining the ability to work remotely year-round.

Continuous Involvement: One of the Clubs' obvious strengths is their ability to quickly gather large amounts of data with less bias than external actors. However, it is paramount to not limit Club participation to surveying, data collection and brokering access to subjects. To maximize the potential for impact, the Clubs should be involved in all steps of the research and design process. This will minimize wasting time and resources on well-intentioned, externally-conceived solutions that are not locally feasible.

Support Structure: The proposed methodology requires significant resources and is not recommended for a one-off project. Rather, the creation of such collaboration networks should be part of a well-defined, university-supported initiative. This ensures that the Clubs, local staff, faculty, and students have the resources needed to promote effective partnership on sustainable development projects. Such an establishment would also ensure proper continuity of student researchers engaging multi-year projects.

6 Acknowledgements

This work was financed by several institutions within the University of Notre Dame, including the Kellogg Institute for International Studies, the Grand Challenges Scholars Program in the College of Engineering, and the Paula A. Connors fund in the College of Engineering. The research described herein would also not have been possible without E2E staffers Gede Benoit and Edson Jean, nor the creativity, time, and passion of the Innovation Club members themselves.

References

- Barreteau, O., Bots, P.W.G., and Daniell, K.A. 2010. A Framework for Clarifying “Participation” in Participatory Research to Prevent its Rejection for the Wrong Reasons. *Ecology and Society*. **15(2)**: 1.
- Daniell, K.A., White, I., Ferrand, N., Ribarova, I.S., Coad, P., Rougier, J.e., Hare, M., Jones, N.A., Popova, A., Rollin, D., Perez, P. and Burn, S. 2010. Co-engineering Participatory Water Management Processes: Theory and Insights from Australian and Bulgarian Interventions. *Ecology and Society* **15(4)**, 11.
- Eberhard, M. O., Baldrige, S., Marshall, J., Mooney, W., and Rix, G. J. 2010. The Mw 7.0 Haiti Earthquake of January 12, 2010: USGS/EERI Advance Reconnaissance Team Report. U.S. Geological Survey, Reston, Va.
- IDEO. 2009. *The Human-Centered Design Toolkit*. Palo Alto, CA.
- IDEO. 2015. *The Field Guide to Human-Centered Design*. Palo Alto, CA.
- Kijewski-Correa, T., Taflanidis, A. A., Mix, D., and Kavanagh, R. 2012. Empowerment Model for Sustainable Residential Reconstruction in Léogâne, Haiti, after the January 2010 Earthquake. *Leadership and Management in Engineering*, **12(4)**, 271-287.
- Lehmann, M., Christensen, P., Du, X., and Thrane, M. 2008. Problem-Oriented and Project-Based Learning (POPBL) as an Innovative Learning Strategy for Sustainable Development in Engineering Education. *European Journal of Engineering Education*, **33(3)**, 283-295.
- Margesson, R., and Taft-Morales, M. 2010. Haiti Earthquake: Crisis and Response. Congressional Research Service.
- Mix, D., Kijewski-Correa, T., and Taflanidis, A. A. 2011. Assessment of Residential Housing in Léogâne, Haiti, and Identification of Needs for Rebuilding after the January 2010 Earthquake. *Earthquake Spectra*, **27**, 299-S322.
- Presuma, L. and Jean, E. 2014. Community Engagement in Developing New Housing Typologies. In: *Haitian Studies Association Annual Conference, Nov. 6-8, Notre Dame, IN*.
- Sanders, A. B. 2005. Barriers to Homeownership and Housing Quality: The Impact of the International Mortgage Market. *Journal of Housing Economics*, **14(3)**, 147-152.
- Sheller, M., Montalto, F., Galada, H., Guirian, P.L., Piasecki, M., O’Connor, S., and Ayalew, T.B. 2014. Participatory Engineering for Recovery in Post-Earthquake Haiti. *Journal of Engineering Studies*, **6(3)**, 159-190.

How Do Graduate Civil Engineers Working in London Learn Global Responsibility and Support UN Sustainable Development Goals?

Shannon M. Chance^{1,2}, Inês Direito¹ and John E. Mitchell¹

¹ Centre for Engineering Education, University College London, United Kingdom

s.chance@ucl.ac.uk

² School of Multidisciplinary Technologies, Technological University Dublin, Republic of Ireland

Abstract

In this paper, we report what topics the participating engineers associated with global responsibility and how they learned about the topic over time. We then compare the findings with the UN's SDGs and with recommendations by PwC regarding where engineers can make the most difference related to the SDGs.

1 Introduction

What values and practices related to global responsibility have civil engineers in London taken from university to apply in their work as civil engineers today? How do these activities overlap the United Nations' Sustainable Development Goals (SDGs)? To begin investigating these topics, we interviewed nine engineers and asked how they define global responsibility, how they learned about it, and what activities they do in their work they would consider relevant to it.

2 Literature Review

“Humanity has the ability to make development sustainable to ensure that it meets the needs of the present without compromising the ability of future generations to meet their own needs” (Brundtland Report, 1987, p. 15). Achieving sustainable development requires citizens and engineers “to consider much more widely than before the impact of our own lives and of the infrastructure and products we produce, both geographically and temporally” (Broers, 2005, p. 3).

Conducting research for the United Nations, Dugarova and Gülasan (2017) identified six “megatrends” affecting sustainable development: (1) poverty and inequalities, (2) demography, (3) environmental degradation and climate change, (4) shocks and crises, (5) financing for development, and (6) technological innovations. To understand the British perspective on sustainable development and what needs to be done, the UK government solicited an independent review by Dodds and Venables (2005), which projected global trends through 2036. It projected that achieving environmental, social, and economic sustainability would be framed by three primary factors: climate change, globalization, and inequality. Bourn and Neal (2008, p. 11) identified global dimensions in all the following concepts: sustainability, development education, global ethics, human rights, international relations, political analysis, justice and equality, cross-cultural capability, business responsibility, and citizenship, diversity, inclusivity, gender/race/ethnicity/nationality/disability. Whether clients like it or not, “companies from all sectors are having to confront and adapt to a

range of disruptive forces including globalisation, increased urbanisation, intense competition for raw materials and natural resources and a revolution in technology that is challenging the business models of many sectors while forcing all companies to be more accountable to, and transparent with, all their stakeholders” (Preston & Scott, 2015, p. 6). Companies are having to face uncertainties in “energy costs, looming regulation on carbon emissions, concerns about access to raw materials and the availability of natural resources like water” (Preston & Scott, p. 6).

Broers (2005) insists that “engineers need to integrate consideration of whole-life environmental and social impacts – positive as well as negative – with the mainstream and commercial aspects of their work. Wise use of natural resources, minimum adverse impact and maximum positive impact on people and the environment are the targets” (p. 3). With regards to civil engineering and sustainable development, a focus has been applying engineering, science, and technology to meet humanity’s basic needs, ranging from water and sanitation, to food security and shelter, to energy and transport (Bourn & Neal, 2008). Topics falling under this umbrella include, for example: resource consumption, material choices, ecosystem impacts, inclusivity, and social equity.

Creating a new, more effective model for engineering practice will require major re-thinking, with consideration of “what a sustainable, people-centred global economy and society would look like,” say Bourn and Neal (2008, p. 8), and “critical analysis which allows learners to challenge their assumptions and the assumptions of others, to analyse a problem from a range of perspectives and to hear voices they would otherwise not be exposed to, is essential to understanding and exploring these complex issues.”

Engineers must therefore be key players in sustainable development, and have an obligation as citizens not just to act as isolated technical experts. Achieving sustainability through sustainable development will require some significant shifts in behaviour and consumption patterns. Often it will be – and should be – engineers who lead processes of making decisions about the use of material, energy and water resources, the development of infrastructure, the design of new products and so on. (Dodds & Venables, 2005, p. 8)

Are they up for this task? Are university-level engineering programs equipping them to meet this challenge? Topics of relevance for sustainable engineering include the UN’s Sustainable Development Goals (SDGs), various green-building initiatives, and Life-cycle Cost Analysis which considers all costs over time involving the design, construction, operation, maintenance, reuse and/or demolition of engineered components and systems. In 2015, the United Nations adopted SDGs to be reached by 2030, and this has increased the level of demand across the business sector for assessment and accountability (Preston & Scott, 2015). Preston and Scott believe businesses should align with national strategy, and this strategy should increasingly reflect the SDGs to provide “a catalyst for innovation and new market opportunities” (p. 3) but this will require updated tools, strategies, and skills – as well as changes in behavior. Benefits of aligning with SDGs must be promoted to businesses (including engineering companies and the businesses that hire them) “in a way that resonates and can be easily interpreted and incorporated into normal business operations” (p. 3). In summer 2015, PwC conducted an *SDG Engagement Survey* with responses collected from 986 businesses and 2015 citizens – when businesses from Engineering and Construction were asked to “rank the five SDGs where you believe your business (and your value chain) has the greatest impact” (Preston & Scott, 2015, p. 11), the group ranked: (SDG 9) industry, innovation and infrastructure first; (SDG 8) decent work and economic growth second; (SDG 13) climate action third; (SDG 11) sustainable

cities and communities fourth; and (SDG 12) responsible consumption and production fifth. Unfortunately, most sectors selected very similar sets, implying many SDGs are being ignored by business. One of the commonly overlooked SDGs is sustainable cities and communities and thus the engineering sector can have great impact here, where other businesses aren't contributing. Citizens prioritize the SDGs differently than business, for citizens the order of importance was: (1) zero hunger, (2) climate action, (3) quality education, (4) no poverty, (5) clean water and sanitation, and (6) good health and wellbeing. Engineering and Construction can clearly impact these, even though engineering respondents didn't prioritize them.

3 Research Design

This exploratory study was intended to identify shared conceptions of global responsibility and challenges and opportunities surrounding the topic in civil engineering. The research team conducted hour-long semi-structured interviews with nine engineers (eight early-career and one senior engineer), a small and manageable sample size appropriate to identify issues for a more detailed follow-up study. The project was reviewed and approved by UCL's Ethics office. Participants were solicited using email and Twitter posts from EWBK staff, who also scheduled the interviews. After having the interviews professionally transcribed, the research team compared the written text to the audio recording to verify accuracy. Two experienced engineering education researchers worked together, using NVivo 12.0 for Mac to manage and code data. They worked together to achieve thematic coding, regularly discussing and revising the themes and coding structure, and then analyzing data inductively within each theme to make interpretations and collaboratively identify findings. The research design, process, results, and findings were checked for quality by an advisory team composed of four engineers, an ethicist, and an additional education researcher.

4 Results

The interview data revealed what topics the engineers associate with global responsibility and how they have gained knowledge about it. Below, we identify what participants mentioned regarding (1) environmental sustainability, (2) social sustainability, and (3) ethics. Then we describe how they came to learn about these topics in their university degrees (sources of learning), and finally, we look at how what they told us about their work experiences relates to the UN's SDGs.

4.1 Environmental

In the realm of environmental sustainability, they described work related to: materials (selection, efficiency, reuse, chemical processing, weight); carbon (footprint, embodiment, climate change, transport reduction, local sourcing); water (amount and usage, drainage and pollution); site (land use, less groundwork, construction impacts, ecosystems, urbanism); performance (energy and building performance, structures, envelope/fabric, layout efficiency, earthquake resistance, thermal effects); building or system retrofit, and flexibility to change over time; pollution and contamination (including soil remediation); logistics, methods, procurement (integrated vs bolt-on approach, optimizing process or decisions over time); resourcing (including depletion and extraction), and electric power (access to electricity, renewable energy).

4.2 Social

The topics participants choose to discuss in the realm of social justice were: corporate social responsibility (CRS), empowerment of people, linking global to local (impact on local business), outreach to schools and kids, research locally applied, standard of living, supporting charity organizations, urban regeneration (including participatory design and place-based decision making), and working with stakeholders.

In the realm of accessibility, or rather access to essential services, they discussed: transportation and movement; education (including, e.g., need for instruction on how to use the HVAC for building occupants); housing; public spaces; water; electricity; moving goods; communication; and information.

Regarding longevity and future generations they discussed minimizing harm, not mortgaging the future, their own personal goals for the future, and risk assessment and mitigation (including LCA, uncertainty, risk management and trade-offs).

They discussed various aspects of work in, or goals for, developing nations. They also identify the importance of gender and diversity, mentioning: cultural differences; diversity and inclusion; rights and balance regarding gender and diversity. They also talked about engineering and construction projects creating jobs.

Participants, particularly those working for construction companies, mentioned that efficiency often has social benefits. Topics raised about public welfare included: air quality (inside and out); public health and safety; and suicide prevention in the design of public spaces.

4.3 Ethical

Mentions of ethics were scarce. Only two participants mentioned ethics without the topic being raised for them by the interviewer. As a result, we gave a prompt and all nine discussed ethics in some shape of form, with a total of 14 mentions of the word ethics by participants.

P4: Because of the commitment that British companies have to make to acting ethically and not accepting bribes and the like. And we have to do mandatory training around that kind of thing. [...] You have a duty to act ethically and uphold the Code of Conduct [...] For Chartership, you do [have to read about these things]. You have to fulfill all these objectives. Most of them are work-based technical things or management type things, but they have aspects of understanding legal context and understanding aspects of sustainability. So and the, you're tested on that, in an interview.

P6: the ICE [Institution of Civil Engineers] themselves have a Code of Conduct [...] the development of others, in inspiring others that want to pursue a career in engineering, that's also part of it.

Only one raised the topic of corruption without prompting. When the word was mentioned by the interviewer, three other participants had something to say on this topic. Two described observing corrupt behavior, but most said they hadn't experienced such. Six participants discussed occupational health and life safety as an ethical issue, providing 19 passages on job-site health & safety.

4.4 Sources of Learning

We asked participants how they first learned about topics they associated with global responsibility. They identified important introductions from secondary school:

P7: I did Geography at A level, so that was a really good foundation to bringing up both physical and social issues that exist on the globe.

P9: I probably learned more about that in geography in A-level than in the last—. At least consciously.

What they said about their undergraduate studies is of high importance to understand how sustainability has been embedded in the curriculum of engineering degrees. Most participants mentioned learning experiences focused on global responsibility issues.

P3: At university [...] in final year, you could choose your modules and I chose alternative building materials.

P6: at college, here actually, sustainable development is a big part of what we were taught, the importance of it. [...] I'm always referring back to my book knowledge, if you like, from college [... and] good scenario-based work

P8: I did civil and architectural engineering. And a lot of that was about building physics, embodied carbon, understanding how the facade shape things, impacting the space inside. [...] we didn't do anything directly international global, but we did put a lot of emphasis on making sure that our buildings were designed to mitigate those impacts. [...] I knew a lot more about embodied carbon, about thermal effects. [...] most people didn't do nearly as much building physics and environmental design, and architectural design as we did

However, these learning experiences were not always specific to global responsibility.

P4: at university, I guess a lot of the sales part of studying civil engineering is about how it's a global career. It's socially useful. [...] We didn't do any specific modules, or anything, about this kind of thing. It was just general interests.

P7: Actually, the course I did was [...] Civil and Environmental Engineering. I thought that would be engineering from a sustainability perspective but it wasn't. It was more from a sewage-treatment perspective!

Two participants had proceeded into postgraduate studies to learn more holistic approaches to civil engineering.

Participants mentioned learning that happens as a result of today's cultural context. They learn, for instance, from books and magazines. The news and popular media also provide opportunities for learning.

P8: To a certain extent it's increasingly in the news. You know, my generation has always grown up with threat of climate change and not just my generation, it's always been there. Also, increasing awareness of how globalization might impact workers in the Dakar or cause—you know, oil extraction, or mineral extraction, in Africa might cause war, you know. blood diamonds and all those things that came into public consciousness. A lot of it was—as a kid growing up, I became

aware of that. [...] I follow a lot of the news and make sure I keep them up to date with roughly what's going on.

4.5 Relation to SDGs

Early-career engineers face many limitations, and the successes they have often feel small and incremental. Moreover, there is a huge divide between the utopian visions articulated by professional organizations and the actual ability of these young engineers to influence decisions or alter the status quo.

They say they need tools and metrics, and this is in line with what PwC argued in 2015. “Assessing impact is fundamental to valuing the positive and negative contributions a business makes towards the SDGs. Without the tools identified and in use, business will struggle to engage effectively” (Preston & Scott, 2015, p. 26). They also need clearer guidelines and more support from their companies for making globally responsible choices in their work.

In the PwC SDG Engagement Survey reported by Preston and Scott (2015), engineers indicated they could most effect SDGs related to (SDG 9) industry, innovation and infrastructure; (SDG 8) decent work and economic growth; (SDG 13) climate action; (SDG 11) sustainable cities and communities; and (SDG 12) responsible consumption and production.

From the statements provided by these nine civil/structural engineers employed in London, it appears that engineers can also have great influence upon: (SDG 6) ensure availability and sustainable management of water and sanitation for all; and (SDG 7) ensure access to affordable, reliable, sustainable and modern energy for all.

P1: What I'm trying to target in my current research is how you achieve responsibility for the planet and the natural environment, and cross reference it with responsibility for [...] achieving the Sustainable Development Goals, and responsibility towards people. Because the SDG say, “Leave no one behind.” How do you close this divide of people who have no access to clean drinking water, or really just basic things to live in a decent way, let's say? How can the environmental responsibility positively feed in and help the social responsibility?

Engineers' work also can have positive influence upon: (SDG 4) ensure inclusive and equitable quality education and promote lifelong learning opportunities for all; (SDG 5) achieve gender equality and empower all women and girls; (SDG 10) reduce inequality within and among countries; (SDG 15) protect, restore and promote sustainable use of terrestrial ecosystems, sustainably manage forests, combat desertification, and halt and reverse land degradation and halt biodiversity loss; and (SDG 16) promote peaceful and inclusive societies for sustainable development, provide access to justice for all and build effective, accountable and inclusive institutions at all levels. Their collective organizations can also enhance global partnerships: (SDG 17) strengthen the means of implementation and revitalise the global partnership for sustainable development.

By 2020, PwC (Preston & Scott, 2015) expected to see businesses having: identified relevant SDGs; engaged with corporate social responsibility (CSR); specific projects engaging with the SDGs; embedded SDGs in their strategy and their way of doing business; aligned goals with SDGs; identified and be using indicators to track relevant SDGs; issuing annual sustainability reports with regard to the SDGs; and

identified and using tools to assess impact against relevant SDGs. The narratives of the nine civil/structural engineers in our study suggested that some of their employers were meeting predictions.

P9: the Millennium Development Goals, for example. I keep thinking about clean water, poverty, famine, education. That is, they are distinct goals I think maybe the UN set out. I feel like that's separate to how, I, as an engineer, am thinking on a day-to-day basis. [... the set of goals], to me, is their action plan for global responsibility. [...] I think big organizations, small organizations too and big organizations are acting with global responsibility in mind. That doesn't mean it has to be through the projects that they do but it could be through how they invest, say, in Corporate Social Responsibility or in charitable projects that they might sponsor, for example. At project delivery level, I feel like I've worked on projects which do have global responsibility and within it, I would say is at the heart of it.

Members of the sample suggested their companies had: identified relevant SDGs; engaged with corporate social responsibility; and have specific projects engaging with the SDGs. On the other hand, there seems to be quite a way to go in many areas where one would expect to see change by 2020. Narratives suggest civil engineering may be falling behind expectations by not having greatly: embedded SDGs in their strategy and their way of doing business; aligned goals with SDGs; identified and be using indicators to track relevant SDGs; have been issuing annual sustainability reports with regard to the SDGs; and have identified and be using tools to assess impact against relevant SDGs.

Because the profession may be falling behind the expectations stated in the 2015 report, it may be wise to review the 7 steps Preston and Scott (2015, p.28) identified for successful engagement with the SDGs.

1. Agree which SDGs your business and its value chain have an impact on directly and indirectly, in the countries you operate in
2. Agree the methodology and measure your business impact across all these SDGs
3. Understand where your business has a positive or negative impact on each SDG
4. Understand the priorities of the governments your business operates under
5. Prioritise reducing negative impacts and increasing positive impacts according to what needs to be achieved by governments
6. Incorporate this learning into business planning and strategy
7. Evidence how you impact on the SDGs and your contribution
8. Making a smooth transition to this new model where

5 Discussion

Regarding the definition of global responsibility, participants associated social and environmental aspects of sustainability with this umbrella term being promoted by EWBUK who invited us to investigate this topic, but most did not mention ethics and anti-corruption efforts as being crucial elements. Of central importance to understand engineering education practices for sustainable development, most participants could not recall lessons or discussions related to the topic from their university years, suggesting that if these topics had indeed been included in the curriculum, they hadn't been delivered in a way that was 'sticky' enough to be retained. Participants did cite learning that occurred later, on the job and as part of their Chartership process.

As a result of these analyses, we see a need for further research—to investigate the degree to which these patterns hold true more widely. We recommend conducting a survey of civil engineers across the United Kingdom to identify what topics they associate with global responsibility, what aspects of global responsibility they encounter day-to-day, what opportunities and challenges they see in their work, and what could be done by professional organizations to support them in becoming more globally responsible.

The civil engineers in our study expressed efforts and perspectives similar to those of Dugarova and Gülasan (2017), who stated policy makers must be involved if we are to achieve the UN's Sustainable Development Goals.

P3: I'd like to be optimistic about it and I think that we are having to set up and pay attention to it because of legislation, because of global impacts that we've signed. There's the UK government [...] looking to reduce the construction industries' carbon output by 50% in the next eight years or something. I know that goals are being set and we are being driven by the government which I think is generally the only way really to make a change across the industry. I know private sector is much more positive and they are looking to do it all the time for private sector. I think you need that kick from governance that tells you have to do it. I think that is coming in and industry best practice is getting better all the time. The ICE as a driver that is always looking to promote that kind of activity and they see it as really important.

Dugarova and Gülasan asserted that policymakers need to rely on evidence, and they must seek coherence at various levels of policy and places around the world. Moreover, they must work to maximize synergies and minimize risk, and finally, inclusive and broad-based participation is crucial to shaping effective policy and moving forward. Participants in this study told us they need reliable tools for identifying environmental impacts and predicting performance of future constructions. To convince developers and other private clients, they need clear metrics, requirements and imperatives. They need more muscle to push for better decisions, even when these cost more. Dodds and Venables (2005, p.8) believe “engineers must recognise and exercise their responsibility to society as a whole, which may sometimes conflict with their responsibility to the immediate client or customer”. This challenge was at the forefront of discussion in the nine interviews we conducted.

References

Brundtland, G. H., Khalid, M., Agnelli, S., Al-Athel, S., & Chidzero, B. (1987). *Our common future*. New York, 8.

Dodds, R. & Venables, R. (Eds.). (2005). *Engineering for Sustainable Development: Guiding Principles*. London: The Royal Academy of Engineering.

Dugarova, E., & Gülasan, N. (2017). *Global trends: Challenges and opportunities in the implementation of the sustainable development goals*. New York: The United Nations Development Programme and United Nations Research Institute for Social Development.

Preston, M., & Scott, L. (2015). *Make it your business: Engaging with the sustainable development goals*. PwC: London, UK.

PwC, GMIS, & UNIDO. (2017). *Delivering the Sustainable Development Goals: Seizing the opportunity in global manufacturing*. White paper developed jointly by PwC, GMIS and UNIDO. PwC Middle East.

Industry 4.0 as an Enabler for Sustainable Manufacturing: An Educational Perspective

Caoimhe Coleman¹, Sara Abu Selmia¹, Ingrid Carla Reinhardt¹, Dr Jorge C. Oliveira¹, Dr Denis T. Ring^{1,2}

¹ Process and Chemical Engineering, School of Engineering, University College Cork, Western Road, Cork, Ireland

² Corresponding author: d.ring@ucc.ie, +353 86 6098733

Abstract

The chemical engineering sector faces the challenge of meeting the continuously growing demand for their products and services while at the same time ensuring that the industry fully integrates the concepts of sustainable manufacturing. Industry 4.0 provides immense opportunities for the realisation of sustainable manufacturing.

Industry 4.0 is a concept that represents the adoption of techniques and processes by industry to gain competitive advantages in domestic and global markets, and Pharma 4.0 is an iteration of Industry 4.0 that relates specifically to the pharmaceutical and biopharmaceutical sectors. The emerging technologies encountered in Pharma and Industry 4.0 facilitate sustainable value creation, through the implementation of agile and smart technologies leading to highly efficient automated processes driven by an integrated manufacturing control strategy.

The objective of this research is to quantify the industrial opportunities for enhanced sustainable manufacturing and in parallel evaluate the status of Industry 4.0 within 3rd level chemical engineering education and training establishments such as the National Institute for Bioprocessing Research and Training (NIBRT).

The research focuses on cross-linking, as well as the implementation of Industry 4.0 with curriculum development and examines critical aspects of industrial application such as production efficiencies, eco-friendly production, and end-of-life products disposal, providing new educational sustainability benchmarks.

Preliminary findings indicate that students have fundamental knowledge regarding core Pharma 4.0 concepts such as Augmented Reality, Cloud Computing and Artificial Intelligence; however, the structure of the 3rd level engineering education needs to adapt, incorporating a more connected curriculum in order to ensure new graduates can successfully engage with a rapidly developing industry and related Pharma 4.0 concepts. Similarly, training institutes indicate an increasing requirement to re-train staff associated with pharmaceutical and biopharmaceutical industries, to upskill 4.0 concepts among the existing workforce.

Keywords: Engineering Education; Employee Training; Industry 4.0; Pharma 4.0; 4th Industrial Revolution; Survey

1 Introduction

Industry 4.0 is a concept which is geared towards increasingly individualised customer requirements and leverages developments in process automation and data analysis, including cyber-physical systems (CPS), the internet of things (IoT), industrial internet of things (IIOT), cloud computing,

cognitive computing and artificial intelligence to optimise all aspects of processing over the entire value chain of the life cycle of products, according to research by (Vaidya, et al., 2018). Engineering education traditionally focused on the theoretical fundamentals while sustainability inherently relies on optimised processes and products. This paper presents a clear and rational roadmap for curriculum development which exploits the advances of Industry 4.0 as applied to enhanced sustainable production, digital maturity, and data integrity by design.

Achieving sustainability in manufacturing requires a holistic view spanning not just the product, and the manufacturing processes involved in its fabrication, but also the entire supply chain, including the manufacturing systems across multiple product life-cycles. There is now a well-recognised need for achieving overall sustainability in industrial activities, arising due to several established and emerging causes: diminishing non-renewable resources, stricter regulations related to environment and occupational safety/health, increasing consumer preference for environmentally-friendly products, etc. (Jayal & Badurdeen, 2010)

Although there is no universally accepted definition for the term “sustainable manufacturing,” numerous efforts have been made in the recent past, with much more concurrent efforts well underway. The U.S. Department of Commerce defines sustainable manufacturing as: “*The creation of manufactured products that use processes that minimize negative environmental impacts, conserve energy and natural resources, are safe for employees, communities, and consumers and are economically sound.*” (ITA, 2012)

Chemical Engineering (CE) is a versatile discipline, both in education and employment. The taught curriculum is varied, offering problem solving, design, control, management, materials science, safety, economics and environmental impact, in tandem with CE fundamentals, which all prepare students for a range of roles within industry and research. (J.Fletcher, et al., 2017). In recent times many engineering departments around the world have modified their curricula to cater for the increasing importance of environmental and social concerns in the wider community. This research seeks to expand on educational development and in embedding 4.0 in education, a critical technological enabler with sustainability. Chemical engineering continues to evolve rapidly as a profession. It is essential that new graduates have the skills to perform in an ever-wider variety of roles and industries. (IChemE, 2019).

2 Investigating the Current State

For industry to continue developing technologically, a suitably skilled graduate supply chain is essential. Obligation rests with Universities and Training Institutes to ensure graduates are up to date with technology changes. Third level education and training needs to provide students with resources and exercises which mimic industry technologies and practices. The skills gaps across all industries are growing at an unprecedented rate, which is due to the snowballing deployment of advanced digital technologies, rapid advances in AI, and IIoT integration across various industries (Ghobakhloo, 2020). Research by (Rampasso & Anholon, 2019) identifies a growing need for universities to prepare their undergraduate students to work towards sustainable development, and identifies factors that hamper the implementation of an Education for Sustainable Development the transdisciplinary character of sustainability and the excessive focus on environmental issues to the detriment of economic and social issues. Thus, it is evident in the literature that there are many challenges to be overcome by higher education institutions to achieve an Education for Sustainable Development. (Guerra, 2017) (Balsiger, 2015)

The current state of 4.0 in Chemical Engineering education as well as the pharmaceutical and biopharmaceutical sectors was investigated using a range of surveys. Questions were structured to

encourage the respondent to express their professional opinion through open-ended questions as well as specialised formats. One such format is the Likert scale. This style of question is typically used to represent attitude towards a topic. To focus the survey responses according to (Binggeli, et al., 2018), multiple choice questions were used where possible and open-ended questions were limited to short responses. Research by (Saleh & Bista, 2017) examines the impacts of online survey response rates in educational research. The survey results were analysed using a combination of Microsoft Forms and Excel analysis.

2.1 The Current State of Industry 4.0 and Sustainability in Education

Current Chemical Engineering third level students contributed to the initial survey, spanning several year groups (2nd, 3rd, 4th, and Masters) and universities across Ireland (UCC 51%, CIT 22%, UCD 16% and QUB 11%). The principal of this research was to assess the level of 4.0 knowledge among students. The major aims of this survey were to:

- Establish understanding of basic 4.0 concepts such as cloud computing, AR, VR, AI, data integrity by design, smart manufacturing and smart products.
- Establish the suitability of the curriculum to prepare students for the future workplace.

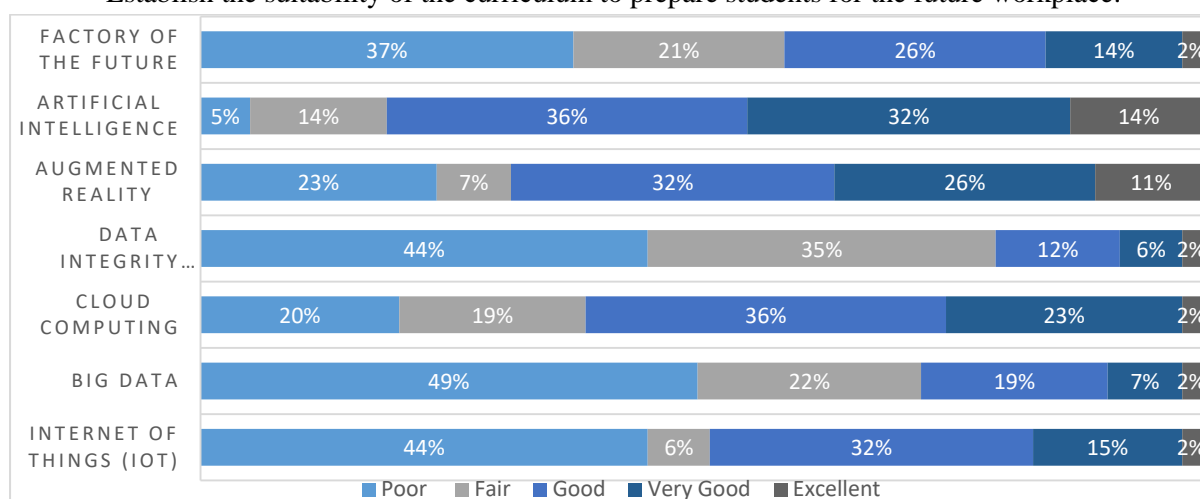

Figure 1- 3rd level student responses indicating knowledge of Pharma 4.0 key concepts (n=81).

Findings indicate that 74% of students – out of a total response pool of 81 – have no knowledge regarding Pharma 4.0 concepts. Of the students who indicated knowledge of Pharma 4.0 (26%) expressed knowledge of Augmented Reality, Cloud Computing and Artificial Intelligence. Figure 1 shows that key Pharma 4.0 concepts such as Big Data, Factory of the Future and Data integrity by Design are not widely known, however, more cross functional concepts such as Augmented Reality and Artificial Intelligence were recognised by a larger number of students. 65%, or 53, of the students questioned indicated that Pharma 4.0 concepts aren't covered as part of their degree. This raises the question of the suitability and modernity of module content. Of the 35% of students which had indicated 4.0 related modules were a part of their university degree, the major topics covered were Augmented Reality, Virtual Reality, Internet of Things, Artificial Intelligence as well as the implementation of continuous bioprocessing and continuous improvement systems.

While the technology behind the revolution has been advancing, the education amongst the current generation of workers has not been developed to match the requirements of industry. This has led to a knowledge gap between the skills of students joining the workforce and the skills they require to thrive in a 4.0 environment. This was evident in the survey results with 14% of all student respondents

indicating exposure to Pharma 4.0 during their work placement but limited to no mention of 4.0 during their time in university, with only 26% having heard of 4.0 before.

From the survey, it was clear that students had not been exposed to Pharma 4.0 as a complete topic; however, individual aspects such as AR & VR, cloud computing, artificial intelligence and cyber systems, were more easily recognised by the respondents. At present students do not have the required skills to apply their fundamental engineering within a 4.0 context.

The survey indicates that technological developments achieved in industry in 4.0 and in its application to sustainability require changes to the current education model. Curriculum change will ensure students will successfully implement and realise the full potential of 4.0.

2.2 The Current State of Industry 4.0 and Sustainability in Industry

A further survey conducted with industry highlight the development of 4.0 in the pharmaceutical sector. Although only 42% of the 78 respondents indicated knowledge of 4.0, the majority of those (70%) identified as Vice-President, Director or Manager. Likewise, when departments within the company were examined, it was found that the bulk of respondents which indicated a knowledge of 4.0 identified with either the Automation or Engineering department. A similar trend was seen with regards to experience level – respondents with more than 8 years of experience were more likely to have knowledge of 4.0, with 82% of the responses. This indicates both the lack of a younger workforce presence in higher management positions and the lack of 4.0 knowledge among younger respondents.

The principal areas of focus with regards to 4.0 adoption which would affect key skills required by graduates are identified in Figure 2. Optimisation is the clear leader and this work will further show that industry are utilising this optimisation opportunity to fully explore the boundaries of implementing sustainability goals.

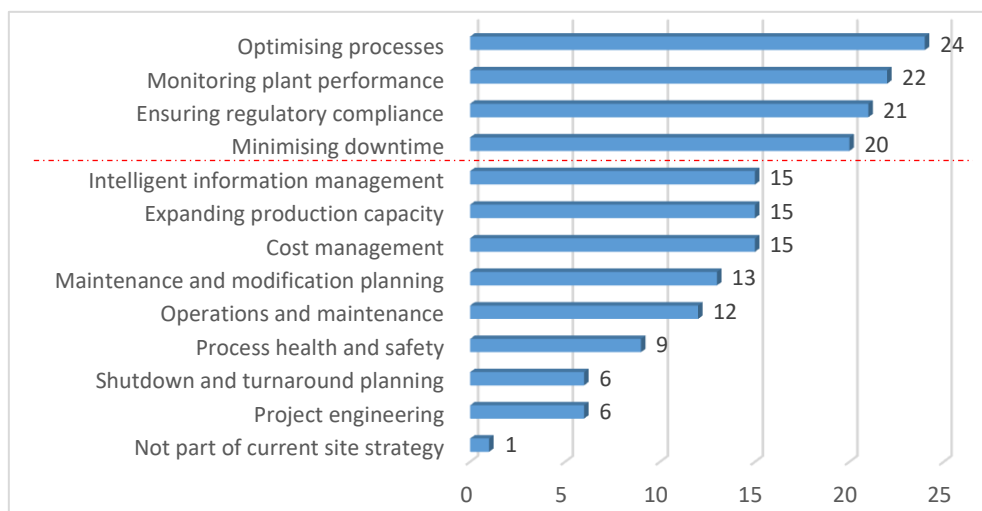

Figure 2 - Principal areas of 4.0 focus, top areas demarcated, n=179.

3 How is 4.0 framing the implementation of Sustainability

Optimisation projects currently being implemented by J&J Ringaskiddy Cork gives an insight into how 4.0 is influencing overall modern manufacturing strategies with respect to sustainability. The ability to access key process data and metrics 24/7 is generating significant opportunities with respect to achieving enhanced sustainability goals. Two 4.0 technologies/sustainability project areas are in operation.

- Project Cold Chiller Optimisation
- Project enAIR HVAC Optimisation

3.1 Project Cold

The conversion of an all-variable speed, water-cooled chiller plant powered by OptimumLOOP™. With the goal to increase COP (coefficient of performance), reduce site carbon footprint and operational spending. To date energy efficiency increases of 60% have been achieved through the use of OptimumLOOP™ a patented, state-of-the-art software that provides continuous, system-level optimisation of the centrifugal chiller. The control algorithms automatically calculate the most efficient operation of the chilled water system to minimise total system coefficient of performance (COP). This system is enhanced with the inclusion of OptimumMVM™, a web-based measurement, verification, and management software-as-a-service (SaaS) platform incorporating OptimumMVM, which acts as a continuous feedback loop that provides detailed, real-time, and historical performance information. The system enables operators to quickly detect, diagnose, and resolve system faults as they occur. Additionally, it provides 24/7 access to efficiency performance metrics critical to benchmarking and maintaining efficient operation year after year.

Project Goals and metrics

The savings associated with this project were 914,293 kWh and 1,586 m³ of water per year, giving an annual CO₂ reduction of 489,451 kg/year.

Table 1 - Monthly savings included in terms of \$ savings and COP data for 2019.

Timestamp	Dollars Saved (Currency)	Actual kW/Ton (COP)	Old kW/Ton (COP)	Project kW/Ton (COP)
02/01/2019 00:00	9377.85	7.40	3.82	6.06
03/01/2019 00:00	8027.53	5.99	3.82	5.92
04/01/2019 00:00	8492.31	6.30	3.86	5.89
05/01/2019 00:00	9872.99	6.55	4.08	5.76
06/01/2019 00:00	12674.47	6.36	4.13	5.40
07/01/2019 00:00	20086.90	6.34	4.03	5.06
08/01/2019 00:00	14632.67	5.99	4.12	5.28
09/01/2019 00:00	13161.72	6.28	4.17	5.42
10/01/2019 00:00	13330.07	7.24	4.21	5.62
11/01/2019 00:00	14538.03	8.51	4.23	5.66
12/01/2019 00:00	14424.65	8.38	4.22	5.69
01/01/2020 00:00	13841.76	8.42	4.21	5.73
02/01/2020 00:00	4796.70	8.81	4.24	5.68
	157257.63			

3.2 Project enAIR (HVAC optimisation)

This Heating Ventilation and Air Conditioning (HVAC) project utilised Optimum’s holistic optimisation platform design to delivers continuous real time data collection (RTDC) year after year with minimum effort. Optimum deploys software within the HVAC system via a networked application that acts as a gateway between the building automation systems (BAS) and the cloud-based management platform. This holistic approach to HVAC optimisation lays the framework for keeping the central plant operating at maximum efficiency. The control strategy utilises OptimumAIR is patented, state-of-the-art configurable software that provides continuous, system-level optimization

of air handlers. Its relational control algorithms automatically calculate the most efficient operation of the air handlers to minimise total system energy use.

Project Goals and metrics

The benefits of implementing Project enAIR:

1. Increasing HVAC system efficiency
2. Cutting energy consumption
3. Lowering carbon emissions
4. Understanding the operational issues currently impacting energy and financial savings goals
5. Developing an optimisation project plan and budget

4 The Engineering Degree - Evolving to 4.0/Sustainability

This research identifies two fundamental concepts:

1. The impact 4.0 is having across all areas of manufacturing
2. Sustainability increasingly relies on enabling technologies such as 4.0.

Engineering education has adapted relatively successfully to incorporate sustainability as an essential curriculum constituent. To enable the chemical engineers of the future to fulfil their role in society, accreditation processes must enable and promote sustainability as a core operating principle (Mitchell, 2000). As evidenced by the examples highlighted, meaningful sustainability makes extensive use of enabling technologies such as 4.0. The key to success is to integrate education with the ongoing advancements in industry. The pedagogical question arises, it possible to create a learning space that promotes connection and collaboration with industry at the same time as enhancing the student learning experience through technology and 4.0? The site wide savings for J&J Ringaskiddy shown in Figure 4 give an insight into how academic design exercises should incorporate real world metrics.

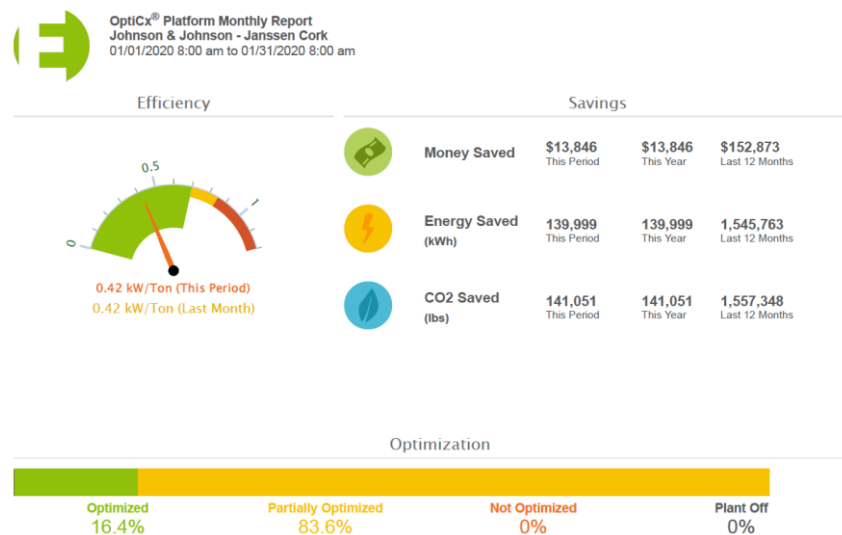

Figure 3 - J&J optimisation graphics.

Systemic design evaluation, incorporating the metrics of money, energy and CO₂ will promote the development of critical thinking skills helping students to understand the real complexity of sustainability issues and provide the competence to move beyond the tradition of breaking problems down to disconnected parts. (Conlon & Nicolaou, 2013). In Chemical engineering we call these disconnected parts “Unit Operations” which remains the fundamental way of teaching students. Industry has moved to an integrated system approach many years ago, and the advent of 4.0 as a

powerful integrating force has greatly accelerated this process. Shifting from the traditional teaching to a framework of Education 4.0 requires the interweaving of traditional unit operations combined with 4.0 enabling technologies that take a systems wide sustainability approach.

5 Educational Perspective 4.0/Sustainability

This research examines the Educational Perspective of Industry 4.0 as an enabler for sustainable manufacturing. The case studies from J&J Ringaskiddy, Cork highlight an industry increasingly utilising enhanced technology to drive sustainability goals; no longer relying on seismic shifts in design or operational applications such as green chemistry or process intensification, but rather by utilising the power of data driven incremental improvements across every aspect of production. Engineering education can also adopt this approach. Degree structure is currently structured with modules and semesterisation, however these present an inherently disconnected model. When asked to comment on this disconnect one student noted: *“Most concepts are unique to the modules we come across them in. I feel like we learn the material for the exam and promptly forget it again”*.

This research proposes to challenge this disconnect by the use of identical and repeated “learning outcomes” across modules and semesters, and a possible concept is outlined here.

Learning Outcome: Evaluate the role of 4.0 technologies as a powerful enabler towards greater sustainability

- PE1003 Introduction to Process & Chemical Engineering
 - **Recycling Materials (glass, metal, plastic, wood, mixed packaging)**
- PE2011 Process Plant Design & Commissioning
 - **Chiller Example (Laboratory COP)**
- PE3009 Pharmaceutical Engineering
 - **HVAC Example (Clean Room Case Study)**
- PE4001 Process Design & Feasibility Analysis
 - **Heat Exchange Networks (WFI heat recovery)**

6 Conclusion

This paper has presented 4.0 technologies as enabling industry to implement systematic, holistic sustainability goals. The sustainability and 4.0 case studies from J&J Ringaskiddy Cork for a chiller plant and HVAC optimisation were outlined. Research into the current state of 4.0 in education and industry identifies that 4.0 is becoming an exceptionally powerful force for change. However, while industry is progressing at an exponential pace – and incorporating the available 4.0 technologies – the knowledge gap between education and working life for graduates is widening. The ever-increasing importance of sustainability is established, but the context of 4.0 has shifted the focus from singular isolated gains, to incremental improvements across all systems utilising high levels of data visibility.

The J&J sustainability case studies illustrate the profound effect 4.0 is having in relation to industrial advances in terms of overall process efficiency. These examples are then retrofitted across a range of modules and years of engineering education, detailing how pedagogy can redevelop curriculum to integrate sustainability within the context of the powerful enabling technologies, namely Industry 4.0.

A proposed shift with respect to learning outcomes for engineering education is outlined, to allow for a through line approach to the degree, linking together modules and semesters by adopting “doppelganger” learning outcomes with 4.0 concepts and sustainability at the core. The learning outcomes specifically lean on 4.0 as the enabling technology and utilise real world examples provided by industry partners such as J&J Ringaskiddy Cork. Industry 4.0 is an enabler for sustainability goals,

and the role of education is to empower the future workforce, both with regards to technology and sustainability among others. The risk for engineering education is very stark, considering the speed at which industry is adopting 4.0 and the vast connected world of optimisation possibilities it generates. The graduate of the future is entering a connected world, they need a connected curriculum.

7 References

- Balsiger, J., 2015. Transdisciplinarity in the class room? Simulating the co-production of sustainability knowledge. *Futures*, Volume 65, pp. 185-194.
- Binggeli, L., Heesakkers, H., Woelbeling, C. & Zimmer, T., 2018. *ispe.org/pharmaceutical-engineering*. [Online]
Available at: <https://ispe.org/pharmaceutical-engineering>
- Conlon, E. & Nicolaou, I., 2013. *The Integration of Sustainable Development Competencies in*. s.l., Technological University Dublin.
- Ghobakhloo, M., 2020. "Industry 4.0, Digitization, and Opportunities for Sustainability.". *Journal of Cleaner Production*, Volume 252.
- Gilchrist, A., 2016. *Industry 4.0: the industrial internet of things*. s.l.:Apress.
- Guerra, A., 2017. Integration of sustainability in engineering education: Why is PBL an answer?. *International Journal of Sustainability in Higher Education*.
- ICChemE, 2019. *Accreditation of chemical Engineering programmes*, s.l.: IChemeE.
- ITA, U., 2012. *How does commerce define sustainable manufacturing?*. [Online]
Available at: <http://trade.gov/sustainablemanufacturing>
- J.Fletcher, A., Haw, M. D. & Sharif, A. A., 2017. Using the perceptions of chemical engineering students and graduates to develop employability skill. *Education for Chemical Engineers*, Volume 18, pp. 11-25.
- Jayal, A. & Badurdeen, F., 2010. Sustainable manufacturing: Modeling and optimization challenges at the product, process and system levels. *CIRP Journal of Manufacturing Science and Technology*, 2(3), pp. 144-152.
- Lee, Bagheri, J. B. & Kao, H.-A., 2015. A Cyber Physical Systems architecture for Industry 4.0 based manufacturing systems. *Manufacturing Letters*, Volume 3, pp. 18-23.
- Lu, Y., 2017. Industry 4.0: A survey on technologies, applications and open research issues.. *Journal of Industrial Information Integration* , Volume 6, pp. 1-10.
- Mitchell, C., 2000. Integrating Sustainability in Chemical Engineering practice and Education: Concentricity and its Consequences. *Process Safety and Environmental Protection*, Volume 74, pp. 237-242.
- Rampasso, I. S. & Anholon, R., 2019. Analysis of the perception of engineering students regarding sustainability. *Journal of Cleaner Production*, Volume 233, pp. 461-467.
- Robert D. Boroujerdi, J. C., 2016. *Profiles in Innovation - Virtual & Augmented Reality*, s.l.: s.n.
- Saleh, A. & Bista, K., 2017. Examining Factors Impacting Online Survey Response Rates in Educational Research: Perceptions of Graduate Students.. *Journal of MultiDisciplinary Evaluation*, Issue 13, pp. 63-74.

Schmidt, R. et al., 2015. Industry 4.0 - Potentials for Creating Smart Products. *Spinger International Publishing*.

Vaidya, S., Ambad, P. & Bhosle, S., 2018. Industry 4.0—a glimpse. *Science Direct*, pp. 20, pp.233-238..

Re-Structuring Practice for Sustainability: Learning from Case Studies

S. Danes¹ and C. Stevenson²

¹ School of Architecture, Carnegie Mellon University, United States

sdanes@cmu.edu

²The AUROS Group, United States

Abstract

One of the biggest challenges in professional education today is to re-structure paradigms of practice to achieve higher-performing buildings and more livable communities. While great progress is being made in building performance research, there is often a great gap between research and practice. This paper is based on the idea that the typical highly resource-consuming development widely practiced today is a symptom of a deeper problem, which is an ineffective design process. To create sustainable buildings or communities, students and practitioners need a better model for incorporating empirical information into design. Three case studies in sustainable design can offer insights into the kind of design process needed to turn theories of sustainability into reality.

1 Introduction

A lot of research is going into improving building technologies to reduce energy consumption, carbon emissions, or waste products (Loftness, 2004). But this progress in building science research is far ahead of what is being practiced in the field (Vischer and Zeisel, 2008). Even without the challenge of climate change, buildings account for a great share of resources and affect people's lives and poor design decisions have negative impacts for many years...can't afford wrong decisions (Sroufe et al, 2019).

Building science research is widely published and available (Straube, 2012). Software tools are advancing the capacity to simulate and predict the consequences of design decisions. One major reason that we are not seeing the widespread improvements that such research makes possible is that the conventional project development process itself divorces decision-making from the knowledge needed to inform those decisions (Bobbe et al, 2016). It is linear and siloed.

The integrated design process (IDP) is widely advocated as the primary means to achieving high performance design goals by organizations such as the American Institute of Architects, the US Green Building Council, the National Institute of Building Sciences, and comparable organizations in Europe and Canada (Koch and Henrik, 2013). The shortcomings of the conventional design process derive from the fact that early decisions by architect and client, which are also the most impactful, are made without the benefit of engineers and other specialists, who are brought into the project much later. "There is a limited possibility of optimization during the traditional process, while optimization in the later stages of the process is often troublesome or even impossible." (Larsson, 2005).

More specifically, the characteristics of the conventional design process that hinder the creation of innovative and sustainable buildings are:

- **Linearity:** the expectation that problems can be solved one at a time—first the architectural concept, then engineering systems (Trumpf et al, 2007). In the conventional linear process, engineers are required to retrofit the building design with building systems. Just as problematically, most engineers are not prepared to engage in an iterative process, which costs more time than a one-time solution.
- **Silos:** specializations in education and business model. Each specialized consultant works within a defined framework of established and unchallenged “givens”, which prevents holistic thinking and the breakthroughs such thinking makes possible.
- **Ill-defined goals:** Owners and architects who have great aspirations but only a general idea of goals often default to certification standards or “best practices” rather than devoting the effort to establish quantitative targets. Without such targets, the design team has neither guidance nor accountability.
- **Reliance on mechanical equipment (and mechanistic thinking):** Most design and engineering professionals in the field today are better educated in mechanical systems than in utilizing natural processes. Specialization, which narrows the definition of problems, tends to reinforce mechanistic models of thought (Hjorth & Bagheri, 2006).
- **Construction cost estimating disconnected from the process:** In conventional design, cost estimating is not undertaken until a substantial amount of design work has been done. Like other specialists, cost estimators appreciate having as much detail to work with as possible, but their input is so late in the process that the only way to reconcile the project with the budget is to cut out scope, which means performance. Moreover, in conventional design process, consideration is given only to first-time construction costs, not long-term operations costs or return on investment.

In an integrated process for sustainable design, a digital simulation of building performance is created early and used as a guide for iterative design schemes: a design proposal is generated, its performance (eg, energy consumption or air infiltration) is tested by modeling it, and the cost to build it is determined with a detailed construction cost estimate. With the benefit of concurrent simulations and cost estimates, passive strategies are fully explored before active strategies are considered. The reduced demand for energy achieved with passive strategies is directly responsible for savings in reduced active (mechanical) systems. At each point in the process, the design team can see how their proposal compares to the project’s targets, and the owner can see the value of each improvement in performance. With iterative cycles of designing, modeling, and costing of the envelope/MEP systems, the team is able to align their design strategies to meet the owner’s goals.

This paper examines three projects with ambitious sustainability goals. Each of the three projects grew out of a strong commitment to sustainability. Among other goals, they aspired to a high-performance building that would require far less energy and produce much less carbon than what is typically built today. Each project has its own goals, drivers, and challenges, but they all demonstrate the critical role that re-structuring the design process plays in turning theoretical possibilities into actual realities.

Case Study 1: East Liberty Presbyterian Church

East Liberty Presbyterian Church (ELPC) in Pittsburgh, Pennsylvania, was built in the 1930s in the Gothic style, a signature building of the renowned architect Ralph Adams Cram. The building is heated by its original steam boiler system, which was typically run continuously for six to seven months each year. Increasingly warm summers and the lack of air conditioning meant that summer programming had to be limited to avoid using the warmest areas in the building. Moreover, the church realized that even without improving comfort, the cost of operating such a large building would consume an increasing

proportion of its resources, leaving less in the future to serving the community. In 2014, ELPC began planning the church building's first comprehensive renovation, with the intention of becoming better stewards of its built and natural resources. The project goals included better use of space with enhanced comfort, improved energy performance, and water conservation, along with meeting current code requirements.

The church hired its design team with the stated goal of improving the sustainability of the building, but project initially took a traditional approach to design and construction. The first schematic design ended up with construction costs that were double the intended budget of \$6 million, excessive operating expenses, and uncertainty about the effectiveness of the proposed cooling system. The leadership at ELPC recognized that the only way to meet its project goals was to reassess its traditional approach to design and construction.

So instead of undertaking the expected value engineering and moving on to design development, ELPC invested in a whole-building performance model, a detailed digital simulation, to understand how the existing building was functioning. Digital meters and both interior and exterior sensors were installed. Whole building blower-door tests were run, and a thorough inventory and life-cycle assessment of all active mechanical systems was made. With this empirical evidence, ELPC created a comprehensive Owner's Performance Report to define the project goals and targets. The report gave the team specific tangible information, and together the building performance specialists, design team, and client were able to use the model in an iterative and collaborative process. By pinpointing the sources of energy consumption, the team was prepared to restructure the process in accordance with the "natural order of sustainability" (Mazria, 1979), passive first, active second, renewable last.

The most difficult challenge was to make the building more comfortable during hot weather. Everyone was surprised by the discovery that Ralph Adams Cram had designed a sophisticated natural ventilation system for the building, which had not been used for decades. Secondly, it was determined that the thermal lag of the building's mass could be used to provide greater cooling by bringing in nighttime air. In addition, a mock-up of summertime conditions demonstrated that a combination of dehumidification and air movement strategies would be sufficient to bring the building into the comfort range.

The project had many passive strategies, despite the limitations of historic design, including repairing the original windows, adding weathertight gaskets, and installing new glass-door airlocks at building entrances. The subsequent active strategies included uncoupling ventilation from cooling, adding a dedicated outdoor air system (DOAS) system to provide filtered and dehumidified fresh air, installing a new building management system to control all active systems, scheduling nighttime purge ventilation to take advantage of free cooling, and creating an energy-management platform and dashboard to measure and monitor whole-building energy use and indoor air quality.

Through this alternative process, the team produced a final design that was within the project budget, met the goal of using 30–40 percent less energy than in pre-construction performance, and provided superior indoor air quality throughout the entire church building. ELPC completed construction at the end of 2018, and the current energy trends are well within the predicted performance targets.

ELPC is using its smart building infrastructure to continuously improve overall building performance. While this is not yet a Zero-Energy building, the approach taken by the project team sets ELPC up for the addition of renewable energy sources. By reaching the church's energy goals through the combination of

passive and active strategies, ELPC has in place the most cost-effective path possible to reach Zero-Energy with future production of renewable energy. Lastly, in December of 2018, ELPC became the first church in the world to achieve RESET Air Certification for Interiors.

Case Study 2: Mycelia Development Cultural Arts Center

Mycelia Development is a small but forward-thinking organization headquartered in Beaver Falls, PA, an underserved community that has not recovered from losing its major industrial employers in the 1980s. The name, Mycelia, references the “root structure of mushrooms”, which are “always committed to the benefit of the host environment”. Mycelia Development set out to invigorate the economically depressed community with a beautiful, high-performance building (appropriately named the “Portobello” building), providing a space for visual and performing arts, events, and farm-to-table food.

From the outset, Mycelia Development’s Portobello Building was envisioned as a change agent for its employees, the town, and the region, as well as a robust example of sustainable building practices. Despite the energy intensity of ceramic kilns, café equipment and theatrical lighting, the owner’s aspirations included net zero energy, superior indoor air quality, low-embodied energy materials, and balanced storm water management with zero outflow from the site. Portobello set out to use Passive House (PH) principles with the intention of obtaining certification under the Green Building Initiative’s Green Globes system (a requirement for funding), RESET Air, and Fitwel.

What happened is the story of a well-intentioned owner whose team was only superficially committed and modestly prepared to deliver on the ambitious vision of a transformative project. While the groundwork was laid for an integrated empirically based design process, the team soon fell back into the more familiar and traditional siloed process, and their decisions were not aligned to the project goals.

Mycelia began the development project by retaining an owner’s representative, experienced in LEED checklists but with little experience in that role. In 2018, Mycelia terminated its first architect, as it had become clear to the owners that this project team was not serious about pursuing the project’s sustainability goals. Mycelia then engaged a second architect and the AUROS Group to work with their original engineering team.

The AUROS Group’s first step was to engage the project team in a Discovery Charrette, where Mycelia’s goals were quantified as specific targets and recorded as the Owner’s Project Requirements (OPR). This critical step paved the way for accomplishing the ambitious project the team envisioned. The OPR was modified and improved over the next 5 months, but the team failed to appreciate that to achieve aspirational building performance goals requires teams to integrate their work early in planning.

The second step was to produce a whole-building performance model along with a base construction estimate. The modeling report and cost estimate were shared with the owner, architect, engineers, and contractor. However, instead of using the information to revise the design, the team chose to pursue their initial proposal. It became apparent that the architect was committed to a dramatic design idea for the building and feared that it would be compromised by attempts to improve the performance of the building envelope. Adding to the problem, the mechanical engineer was unwilling to adjust or detail the narrative produced in the conceptual design phase and so were unable to address the OPR goals. Neither the owner nor owner’s representative intervened to redirect the design process.

It is important to note that, based on experience in other recent projects, the first round of simulation indicated that the project was within reach of meeting both the OPR targets and the owner's budget of \$4.4 million. While it required design modifications, the kinds of changes needed were achievable and could be accomplished without significant increases in cost. In this case, however, the design team chose to pursue a traditional path, which also deprived the owner of any basis for questioning the contractor's ever-increasing prices.

In short, as the project is moving into the final phase before construction, the owner has abandoned the OPR, reverted back to building code-based standards, and is focused on meeting only the lowest requirements for Green Globes certification. Performance simulations have been disconnected from design decision-making, and those decisions have been made without the benefit of performance analysis. The project construction budget, which began at \$4.4 million, is now reportedly over \$5.5 million, while nearly all the high-performance project goals have been sacrificed. The schedule has been pushed back 12 months. At its final completion, the project is not likely to achieve much beyond code compliance.

Case Study 3: Belleview Neighborhood

Belleview, a new compact neighborhood in a small western city, is also intended to be a model of sustainable design. It is envisioned as a diverse neighborhood where families at various income levels, stages of life, sizes, and backgrounds can afford to purchase a home. The town has been experiencing nearly thirty years of unprecedented growth, mostly suburban sprawl. Population growth has fueled fast-paced increase in real estate values, which in turn has created an affordability crisis. Today, this is most acutely felt by households in low-paying jobs, including municipal service workers. A successful compact neighborhood might open the door to more affordable housing and more sustainable patterns of development. Climate change is contributing to extreme temperatures: more severe winters and hotter dryer summers. The harsher weather in recent years is driving up monthly utility bills, making affordability an issue of long-term operations as much as initial purchase price.

The new neighborhood features 60 housing units on an eight-acre site. They range from an 800 square foot one-bedroom cottage to a 1500 square foot three-bedroom gable-front house. All housing types have generous front porches and modest private yards. The houses are intended to minimize their environmental footprint by compact site and building design and their highly insulated, well-sealed building envelope. The design team was committed from the outset to a performance-oriented design process. Based on the natural order of sustainability, the building designs first incorporated passive strategies. In addition to their compact shape, most are attached with shared party walls to reduce exposure to outdoor weather. Projecting eaves and deep porch roofs help shelter interior spaces from overheating. Outdoor spaces, such as the three common courtyards, are sheltered with trees, fences, and building walls.

Iterative modeling simulated the hygrothermic behavior of the envelope, guiding the design process from the outset. One significant finding from the initial model was that building orientation was not a major factor in performance due to the highly insulated and strategically shaded building envelope. A preliminary estimate of construction cost was done along with the energy model, as the design team was well aware that the developer could not sacrifice affordability for optimal performance. While the developer had not given the design team a construction budget, the anticipated cost per square foot was in line with recent housing construction in the area.

The site and housing design, informed by the results of the modeling, used strategies that the team knew were both energy-conserving and cost-effective. Even in early design, the houses incorporated features such as thick walls and carefully placed windows which would be essential to meeting performance goals.

Meanwhile, the developer had determined that the project would be designed and built to meet PH standards, which had been shown to reduce energy demand by as much as 90% with as little as a 3% increase in construction cost. The design team was confident that the project was on track to meet or exceed those goals, based on prior experience with PH design.

Upon submission of the project to the city for approval, the management of the design process shifted from the lead design firm to the local associated firm, which had been involved in the design process from the outset. Several complications made this transition challenging. First, the local architects were less prepared to lead a collaborative and iterative process than the developer thought. Because of inexperience with high-performance housing, they were reluctant to adopt unfamiliar building details, particularly since they understood how critical small leakages could be. They were inclined instead to look for high-performing materials that would allow them to retain as much conventional construction as possible. They were also worried that the cost of PH design would far exceed what was projected, and the developer had still not committed to a construction budget. Secondly, the general contracting firm, which was brought onto the team at this time, was supportive of the concept of higher performance but equally inexperienced in PH construction. Their initial cost estimate, which was based on preliminary design development documents and prior to any training in PH construction, added in a 50% premium. The third factor was a sustainability consultant who convinced the owner to defer the next round of energy modeling in favor of following what were described as best practices, unrelated to any specific performance goals. The consultant also introduced the idea that the primary sustainability goal should be to maximize the use of low-carbon materials in construction, including two products manufactured in and imported from Europe.

What was clearly missing at this point was a set of specific performance targets that would have guided design decisions, facilitated the completion of the design development documents, and provided a well-defined basis for costing. The design team was trying to sort out conflicting priorities from owner, sustainability consultant, and contractor, which resulted in a kind of paralysis. If the process had continued on track, the design development documents based on a second iteration of energy modeling would have been completed in six to eight weeks while the contractor's team was being educated in PH construction to prepare them to produce a more reasonable cost estimate. Instead, the project schedule has suffered a six-month delay and the contractor's cost estimate interrupted further progress until a radical cost reduction could be achieved.

It is possible for this project to get back on track, but while everyone on the team is well-intentioned and believes in the vision of the project, the team suffers from a lack of confidence in the power of a performance-oriented design process to guide decision-making to an environmentally-sound, financially viable, contextually appropriate, and marketable outcome. Falling back onto "best practices" has led to discussions that disintegrate into competing conflicting ideas about how to proceed. They not only exhaust the team but convey the impression that designing for sustainability is even harder to accomplish than they had anticipated.

This experience is not unique. It highlights the pitfalls of trying to accomplish high-performance design by a team—even a committed and collaborative team—that isn't prepared to restructure the conventional process of design and development.

Conclusion: Lessons Learned

While each of the three project teams encountered unanticipated difficulties in reaching their sustainability goals, they have taken important steps beyond conventional practice and more importantly, have had an opportunity to learn from those experiences. The purpose of the case studies is not just to

highlight the kinds of difficulties encountered in designing high-performance buildings, but to identify opportunities for practicing professionals to sidestep some common pitfalls and for researchers to focus on areas for fruitful investigation. As case studies, these projects enabled us to discern a number of patterns that seem to be worth further investigation. We note here two kinds of lessons learned: first, a sequence of key steps in re-structuring the design process and second, a set of proposed requisites for producing a successful high-performance project.

Key Steps

Step 1: Set metric based goals and targets. Then build the team based on a performance-based engagement process and assign the proper responsibilities and accountabilities to achieve the goals.

Step 2. Organize an integrated and iterative process, including modeling and estimating. High-performance building design is a process of successive approximation aimed at meeting the project goals, including quantitative targets. It is essential to break down the “hand-off” design process. Implement early conceptual whole-building sustainability modeling and cost estimating processes that inform iterative design decisions.

Step 3. Set up the design process using the Natural Order of Sustainability. Start with passive strategies: use the non-mechanical architectural elements to lessen the need for energy, which in turn reduces the size and operating cost of mechanical equipment. To accommodate this much-reduced demand most efficiently, decouple heating, cooling, and ventilating systems and introduce heat and moisture recovery. Use energy-efficient equipment and lighting. Finally, add renewable energy generation.

Step 4: Connect quality assurance/quality control field testing and commissioning to the key performance indicators of design. Critically, the “right sizing” of mechanical systems is directly related to the performance of the envelope. A high-performance building is dependent upon the performance of the thermal barrier, air barrier, building envelope, and mechanical and electrical systems. They must be tested to ensure whole-building performance.

Step 5: Evaluate success based on long-term outcomes, not just design. Give the building a measurement and verification system connected to the key performance indicators of design and create feedback loops that track actual building performance and compare it to the design targets. A connected measurement and verification system ensures high-performance operation of the building.

Requisites for creating a high-performing project:

- The owner/client understands the value of a high-performance building and is prepared to achieve it.
- The team is experienced in high-performance building is engaged to work collaboratively from the outset: architect, engineers, building performance consultant, contractor, facilities operator.
- Contract documents for design team define an iterative process and expected level of participation, including generating and testing of multiple alternatives
- Well-defined performance goals are established by team at outset of project (OPR). Budget and other parameters are included.
- The team is held accountable to performance requirements throughout design and construction.
- The OPR drives the choice of sustainability programs, rather than vice versa.
- The team carries out the design process according to the natural order of sustainability: passive first, active second, and renewables last.

- The team evaluates costs associated with any level of performance to determine the best value both in short term and long term. The team's design decisions reflect that evaluation. (While most architects and contractors have the general knowledge to price construction projects, few can demonstrate their design's specific return on investment by doing a cost vs. energy analysis.)
- The team is committed to open, full exchange of information, including open book budget and costing.
- The team displays good leadership and teamwork-habits, including authentic commitment to stated goals, effective communication, timely execution of tasks, and respectful management of conflict.

References

Bobbe, T., Krzywinski, J., & Woelfel, C. (2016). "A comparison of design process models from academic theory and professional practice". In *DS 84: Proceedings of the DESIGN 2016 14th International Design Conference* (pp. 1205-1214).

Fleming, R. & Saglinda, H.R. (2019). *Sustainable Design for the Built Environment*. Routledge.

Hjorth, P., & Bagheri, A. (2006). "Navigating towards sustainable development: A system dynamics approach". *Futures*, 38(1), 74-92.

Kibert, C.J. (2016). *Sustainable Construction: Green Building Design and Delivery*. Wiley.

Koch, C., & Henrik, B. (2013). "The Integrated Design Process, a concept for green energy engineering". *Engineering*, 5(3), 292-298.

Larsson, N. (2005, March 4) "Integrated Design Process: History and Development". *International Initiative for Sustainable Built Environment*. Retrieved from <http://www.iisbe.org/node/88>.

Loftness, Vivian. "Improving building energy efficiency in the US: technologies and policies for 2010 to 2050." In *Proceedings of the Workshop*, pp. 10-50. 2004.

Mazria, E. (1979). *Passive Solar Energy Book*. Rodale Press.

McLennan, J. (2004). *The Philosophy of Sustainable Design: Future of Architecture*. Ecotone Publishing.

Sroufe, R., Stevenson, C. E., & Eckenrode, B. A. (2019). *The Power of Existing Buildings: Save Money, Improve Health, and Reduce Environmental Impacts*. Island Press.

Stasinoupolos, P., Smith, M. H., Hargroves, K., & Desha, C. (2013). *Whole system design: An integrated approach to sustainable engineering*. Routledge.

Straube, J. (2012) *High Performance Enclosures*. Building Science Press.

Trumpf, H., Schuster, H., Sedlbauer, K., & Sobek, W. (2007). "An approach for an Integrated Design Process focused on Sustainable Buildings". *Action C25: Sustainability of Constructions—Integrated Approach to Lifetime Structural Engineering*, Lisbon, Portugal.

Vischer, J., & Zeisel, J. (2008). "Bridging the gap between research and design". *World Health* 57, 57-61.

Walker, S. (2006). *Sustainable by Design: Explorations in Theory and Practice*. Routledge.

Zimmerman, A., & Eng, P. (2006). *Integrated Design Process Guide*. Canada Mortgage and Housing Corporation.

Engineers as advocates for Sustainable Development: countering misinformation and the need for Aristotelian Rhetoric

Richard A Fenner¹

¹Centre for Sustainable Development, Department of Engineering, Cambridge University, Cambridge UK,
raf37@cam.ac.uk

Abstract

The paper argues that engineers need to take action as advocates for sustainable development, and for spotting and correcting fake news and mis-information. The spread of counter factual information is reviewed and its impact on encouraging denial of globally important issues, such as climate change is highlighted. Strategies for responding and correcting misinformation are presented and the importance of understanding and engaging in persuasive arguments through the application of the ethos, logos and ethos of Aristotelian rhetoric is explored. The paper presents examples of classroom exercises where these concepts are considered and developed with engineering graduate students and concludes by calling for such students to develop a voice as advocates for sustainable development.

1 Introduction

A core skill required by engineers in pursuing a sustainable development agenda is to be able to articulate and convince a wide audience with reasons why much of the engineered products and services of daily life need to be delivered in new ways. Traditionally this would be done by having familiarity with the sheer weight of supporting evidence which points clearly and with scientific consensus to the nature of global problems, such as in relation to anthropogenic climate change. But relying on such substantial evidence bases, coupled with strong communication skills, is now no longer enough in a world of post-truth and misinformation where experts are frequently simply derided (such as the entire UK Environment Agency by senior Government ministers). Increasingly responses to these inconvenient truths are simply dismissed as “fake news” and a chorus of denial.

This is perhaps one of the biggest and most insidious challenges to have arisen since the instigation of the EESD Conference series in 2002. For engineers to articulate sustainable responses to global challenges they need to go beyond just being merely experts about whatever issues they are dealing with but to engage using communication skills that also connect with the emotional and moral qualities of their professional and public audiences. Equipping the next generation of engineering graduates with this skill may prove to be the most important challenge of all. The World Economic Forum has ranked the spread of mis-information online as one of the 10 most significant issues facing the world (WEF, 2013).

In her book “Stop Being Reasonable” Eleanour Gordon-Smith argues people are often unmoved by dispassionate logic, peer-reviewed research and statistics, but in fact are swayed by ego, emotion, self-interest and identity. Therefore if we want our engineering students to succeed in implementing change we have to ditch our idealised, sterile picture of persuasion and be more sensitive to how people behave in real life. In embracing this, further steps can be taken to ensure that future engineering graduates have the necessary skills to go beyond the logos, (the hard science and engineering theoretical framing of issues) but to utilise the ethos and pathos of Aristotelian rhetoric in their arguments, if they are to convince a wider world of the need for change. This involves appealing at a moral and ethical level whilst consciously building trust and credibility as well as using approaches which provoke an emotional response in their audience This paper explores how these concepts can be introduced as essential ingredients in engineering education as it is no longer enough just to be “right”.

2. Misinformation in a post truth world

We increasingly live in a world where experts, including those holding an engineering brief, are derided as elitist or untrustworthy if the knowledge and understanding they possess threaten the prejudices of the uninformed. Instead opinions are formed by those who are most influential and vocal on social media. We are already seeing how such mis-information can have devastating consequences where unsubstantiated and thoroughly discredited claims of a link between childhood vaccinations and autism, have resulted in many parents choosing to not immunise their children. This is leading to increases in disease such as measles in the wider population. Thus, an opinion on Twitter becomes the arbiter of behavioural choice

Oxford Dictionaries define “post-truth” as: “relating to or denoting circumstances in which objective facts are less influential in shaping public opinion than appeals to emotion and personal belief”. Being misinformed is often conceptualised as believing in incorrect or counterfactual claims. However, Sheufele and Krause (2019) observe: “The line between being misinformed or uninformed – that is simply not knowing – has long been blurry”.

There is evidence that the presence of misinformation causes people to stop believing in facts altogether (Lewandawsky et al, 2017). For example McCright et al (2016) found that when accurate information about climate change was “balanced” by an opposing mis-framing of the phenomenon this was able to cancel out valid climate information in the way many perceive the problem. The need to give equal weight to both sides of the argument (“false equivalence”) is borne out of the media’s traditional need for scrupulous fairness in relation to political debates, but is highly damaging and dangerous when this approach seemingly skews overwhelming scientific consensus.

But misinformation is about much more than simply being misinformed, and this goes to the heart of our ability to take action on Sustainable Development. Even when such misinformation is corrected many continue to have faith in information they know to be false (known as the continued-influence effect (Lewandowsky et al, 2012)). If the correction challenges a person’s world view, their belief in false information may even increase (a phenomenon being witnessed daily in the UK over the fractious and divisive Brexit debate). Correction to misinformation only works if this doesn’t directly challenge peoples world views, and an explanation is provided why the misinformation was circulated in the first place.

This is closely linked with the notion of confirmation bias which involves favoring information that confirms previously existing beliefs, which can range from regularly buying a newspaper whose editorial pages reflects one’s own political leanings to sinister profiling and targeting of information direct to individuals through social media. The latter has allowed people to select their preferred “echo chamber” in which the contents reinforce pre-existing attitudes and biases. These “filter bubbles” allow the creation of custom–designed information environments, reflecting back our own likes and behaviours and the empowering of people to chose their own reality. The dangers this presents (e.g for achieving Sustainable Development) is captured by Lewandowsky et al (2017) who state:

“Misinformation...implies a blemish on the information landscape – our mirror of reality- that can be cleared up with a suitable corrective disinfectant.....But the post-truth problem is not a blemish on the mirror. The problem is that the mirror is a window into an alternative reality” .

Such beliefs extend, for example, to President Obama being born in Kenya, climate change being a hoax created by the Chinese, the UN trying to install a World Government, or the US Democratic Party

running child sex trafficking from a Washington pizzeria, (Lewandowsky et al, 2017). Such views are surprisingly mainstream in the USA and not easily undermined by empirical evidence or correction by “elitist” experts.

The response is not to improve how contentious information is better communicated, but to understand the mechanisms and societal contexts by which such misinformation unfolds. The emergence of a post-truth world has been attributed to a decline in social capital (Aldrich & Meyer (2015); growing inequality linked to political polarisation (Andersen & Curtis, 2012); declining trust in science and politically asymmetric credulity (where opposing political views are differently susceptible to misinformation). Generally trust in scientists has been found to be lower among the conservative right than on the liberal left (Hamilton 2015). Dunlop et al (2016) have pointed to the polarisation of the climate debate arising from a sustained effort by conservative think-tanks to cast doubt on the overwhelming scientific consensus that the Earth is warming from anthropogenic greenhouse gas emissions. The denial of climate change is more than just an alternative knowledge claim but an organised process deliberately intended to create uncertainty in the public’s mind to justify a continued business as usual approach and to frustrate attempts at mitigation. The technique is not concerned with establishing a coherent alternative explanation of observed phenomenon, but simply to grind down trust in facts and objective science, to the point where facts no longer matter or are not even acknowledged to exist.

The result is facts and objective evidence are trumped by existing beliefs and prejudices. A consequence of this is it is hard for an individual to change what he wants because opposing evidence fails to achieve a purchase (and may simply reinforce what he accepted before). A further factor is that people tend to hold on to views they think are commonly held, irrespective of whether or not this is the case.

One solution proposed to counter these tendencies is to borrow from behavioural economics to “nudge” against the spread of mis-information (Tahler & Sunstein, 2008). Lewandosky et al (2017) suggest “even a few dissenting voices can shift the perceived social norm (i.e the perceived range of acceptable views) thus legitimising opposition and encouraging evidence-based discourse”. However some may see advocacy and science/engineering as fundamentally incompatible manifesting a tension between subjective and objective narratives. Thus science/engineering is concerned with objectively observing and describing how the world works, whereas advocacy is rooted in subjective values about how the world ought to be (Kotcher et al (2017). Mitchell, Carew and Clift (2004) contrasted how engineers might switch from being merely narrow technical advocates for often predetermined solutions to honest brokers of technical information, extending beyond the bounds of a technocentric perspective in three ways: moving away from singular prescribed technology, engaging with problem formulation, and considering problems in a wider context. These are critical skills for future engineers who must go beyond being merely “correct” on an issue borne out of a rigorous understanding of the physical sciences but to engage in ways that are more empathetic in communicating solutions that are rooted in rational analysis.

Concern has been expressed that progressively higher levels of advocacy may result in a scientist or engineer’s perceived credibility being reduced (Donner 2014). Negative judgements about an engineer’s credibility or character if countering misheld views may occur, as it takes less effort to denigrate the individual than to counter-argue the content of the message (Wright, 1973). However. a study by Kotcher et al (2017) found there was no evidence to suggest that the credibility of engineers and scientists engaging in advocacy was compromised.

It should be recognised that misinformation in an individual does not occur in a vacuum, but misperceptions emerge as part of dynamic group interactions, and are shaped by political campaigns and other multi-level forces. A systems approach to understanding the effectiveness of science communication is therefore required (Scheufele & Krause (2019).

McCright and Dunlap (2017) offer a conceptual space of misinformation along two dimensions of realism to constructivism, and formal to informal deliver styles. These are summarised in Table 1:

		Informal Style			
Strong Realism	Truthiness Feeling something is true without the need for reasoned argument or rigorously collected and analysed empirical evidence	Bullshit The liar cares about the truth and tries to hide it. The Bullshitter doesn't care what they say is true or false, but only cares whether or not their listener is persuaded	Strong Constructivism		
	Systemic lies Carefully constructed fabrications or obfuscations intended to protect and promote material or ideological interests with a coherent agenda.	Shock and Chaos Misinformation intended to destabilise social relations and societal institutions so that its proponents may consolidate power and force unpopular decisions on a confused or distracted public			
		Formal Style			

Table 1: Key Types of mis-information (adapted from McCright & Dunlap 2017)

Effectively combating misinformation will require an understanding of these different characteristics and dynamics, and in particular how synergies develop between them to have even more complex and unmanageable consequences.

3. Strategies for responding to counter factual thinking

Engineers may fall into the misconception that that public misperceptions arise from a lack of knowledge and that the solution is more information. Engineering students need to appreciate *how* people process information, *how* they modify their existing knowledge and *how* world views affect their ability to think rationally. People are less likely to accept debunking when the initial message is just labelled as wrong rather than countered with new evidence (Chan et al, 2017).

Some see technology has a role in developing algorithmic fact checkers that detect misinformation and raise alerts when information is returned through search engines. However others have argued that many individuals lack evaluation skills and so can't distinguish dated, biased or exploitative sources (Scheufele & Krause, 2019) . The use of fact checkers needs also to be coupled with strategies that tackle an individual's motivation to actively seek out information that prizes accuracy over other merely reinforcing their pre-existing beliefs.

Refuting misinformation involves dealing with complex cognitive processes. The Debunking Handbook (<http://sks.to/debunk>) proposes that to be effective refutation must focus on core facts rather than the myth to avoid reinforcing misinformation by making it more familiar. Any mention of the myth should be preceded by explicit warnings stating the upcoming information is false, and an alternative explanation should be provided that accounts for why the original misinformation was disseminated in the first place. The strategies are expanded in Table 2:

The Familiarity Effect	The Overkill Effect	The Worldview effect	Alternative explanation
Problem Familiarity increases the chances of accepting information as true (so debunking a myth might actually reinforce it in people’s minds)	Problem A simple myth is more cognitively attractive than an over complicated correction.	Problem For those who are strongly fixed in their views, encountering counter-arguments can cause them to strengthen their views	Problem When a myth is corrected a gap is created in a person’s mind. To be effective that gap must be filled.
Solution First, focus on the facts that need to be communicated, in the following order: <ul style="list-style-type: none">• Core fact emphasised in headline• Core facts reinforced in initial text• Myth• Explaining how the myth misleads	Solution Less can be more Generating 3 arguments can be more successful in reducing misperceptions than generating 12 arguments which can end up reinforcing the initial misperception <ul style="list-style-type: none">• Use simple language, short sentences, clear subheadings• Avoid derogatory comments that alienate people• End on a strong and simple message	Solution Outreach should be directed towards the undecided majority rather than the unswayable minority <ul style="list-style-type: none">• Couple worldview threatening messages with self affirmation (e.g. by asking people about a time when they felt good as they acted on a value that was important to them)• Frame the information in a less threatening way (e.g. “carbon offset” rather than “climate tax”)	Solution Provide an alternative explanation for the events covered by the misinformation Explain why the myth was wrong <ul style="list-style-type: none">• Expose denial techniques of selective use of information, conspiracy theories and misleading testimony of fake experts• Arouse suspicions by suggesting motives why the myth was promoted• Use an explicit warning (“watch out, you might be misled”)• Graphics present evidence better than text

Table 2: Strategies for correcting mis-information (Adapted from the Debunking Handbook 2012)

4. Understanding persuasion

Relying exclusively on an evidence based approach reflects the logos aspects prevalent in traditional engineering discourse, appealing to the rationality and logical integrity of an argument. To be effective in leading change the other aspects of Aristotelian rhetoric, ethos and pathos, need also to be embraced and can add powerful tools in developing the skills of persuasion (Table 3).

Ethos Focus on the author (credibility, trust)	Logos Focus on the argument (consistency, logic, reason)	Pathos Focus on the audience (emotions)
<i>ETHICAL</i> Integrity Track record Background and Qualifications Peer esteem Morality	<i>LOGICAL</i> Reporting and metrics Statistics and Modelling Theoretical reasoning Impact assessment Supporting references	<i>EmPATHY</i> Vivid descriptions Story Telling Legacy
Common pitfalls		
The Entertainers stance: <i>Too much about me, myself and my style (ethos)</i>	The Pedant: <i>Ignoring relationships with the audience and depending entirely about statement on the subject</i>	The Advertisers stance: <i>Undervaluing the subject and overvaluing pure effect</i>

Table 3: Three aspects of Aristotelian rhetoric

Equally these methods of persuasion can influence perceptions of credibility, the spread of viral stories, and belief in factual unsound statements (Haythorn, 2019). Together they can be used to go beyond conveying detail, but to create meaning. So engineers also need to convince and persuade which may require challenging commonly held viewpoints, asking the listener to accept new ways of thinking about a problem, and convincing the audience that others may be wrong.

4.1 Pathos

Pathos is an appeal for an emotional response in the audience, (typically pleasure or fear). For some this is uncomfortable and may be shunned as unscientific or misleading. But when faced with the need for a quick decision, arguments which elicit emotion such as fear are frequently adopted to drive choice. In responding to a new transport initiative, an individual may initially respond positively because it could relieve some daily stress they experience in their own travel arrangements, but after more consideration they may come to see it as negative because of fears over the destruction of some valued part of their environment. A problem arises if decisions are based on this response alone, i.e. in the absence of logos and pathos. This can be seen in the anti-vaccination movement (referred to earlier) which has no proven rational basis but which is becoming responsible for the re-emergence of preventable diseases. Such a response is based solely on an irrational fear of creating autism in children.

4.2 Logos

Logos appeals to logic, as represented in numerical analysis, rational solutions and statistical significance. But this can be open to mis-interpretation, for example when we confuse correlation between variables as explanatory causation of a problem. This is illustrated when concluding that because of high frequency of firefighters observed at building fires, they are responsible for the event. Again used in isolation (without pathos) seemingly logical solutions may be seen as immoral. Decisions reached in isolation of emotional responses, coldly through rational objectivity, should be avoided without reference to ethics and moral conduct. Therefore choices guided entirely by logos can be as bad as those driven by pathos.

4.3. Ethos

Ethos can be defined as the disposition, character, or fundamental values peculiar to a specific person, people, corporation, culture, or movement. It is perhaps a more complex concept than logos or pathos, and Aristotle split the idea into three parts:

- *phronesis*– useful skills, experience & wisdom (good sense)
- *arete* – virtue, goodwill, (good character)
- *eunoia*– convincing the audience of one’s knowledge and intentions (goodwill)

Ethos is vital to a sound argument with only 3 reasons for unsound arguments to exist:

- i) the speaker is wrong due to a lack of good sense
- ii) the speaker is lying due to lack of moral character
- iii) the speaker is silent because they don’t care if the audience hears good advice

It is important to understand that unlike pathos and logos, the root of ethos comes from outside the argument itself. That is the audience must know the speaker’s experience (good sense) and moral character to avoid falling for unsound advice. Establishing credibility and trust is central to the concept, but this is often hard to judge over the internet and through social media, and the *appearance* of credibility alone isn’t enough to judge a speaker as credible.

In seeking to persuade, credibility can be bolstered by using *similitude* (creating a sense of mutual identification using pronouns such as “we” and “us”) and deference (signalling respect for others through personal humility)

So where can an engineering student turn if emotions cloud our judgment and logic is uncertain? Haythorn (2019) and Varpio (2018) suggest some simple tests which can be applied. After hearing an argument or statement, (whether on-line or in person) consider your own position to the piece, and ask:

“How did it make you feel?”

“Does it confirm what you *want* to be true?”

“Do you have any stake in the events at play?”

Then consider the logic of the piece and ask:

“Does everything make sense?”

“Do the numbers add up?”

“Do the findings logically connect to support the conclusions being draw?”

“Are there errors in the author’s reasoning?”

“Does it align with a wider context, or does it seem out of place?”

Finally consider the position of the speaker

“Do they have experience with the topic being discussed?”

“Do they have a history of honesty?”

“Do they benefit from your support of the argument?”

“Who crafted the message and to what end?”

As an entertaining distraction, Grant (2019) analyses Donald Trump’s use of Twitter feeds and campaign speeches to create and sustain fake news, leaning heavily on ethos and pathos, almost to the exclusion of logos. Effective communicators avoid overemphasis on a single appeal, anchoring a presentation in all three (ethos, logos and pathos). Common traps have been identified by Booth (1963) who identified three common imbalances if only one persuasive device was used (see Table 2).

4.4 The use of metaphor

The use of metaphors can be an effective way of communicating with a sceptical public, which use the familiar to explain the unfamiliar. Standard metaphors create explanations that obtain common currency and become universally understood. They provide the hook on which empathy with the issues can be gained. Karlsson (2015) believes finding appropriate metaphors for sustainability, and critically reflecting on their social and economic implications, is crucial to avoid reinforcing values that are inconsistent with sustainability outcomes. He proposes three metaphors that can inform what sustainability actually means and what is at stake in debates which require action from the local to the national and global. These include the familiar ecological footprint; a rocket moving from a sustainable state on the launchpad to a different sustainable state in orbit through the importance of a sustainable trajectory, and a runway (of unknown length) where the occupants of an aircraft can take off into a post scarcity civilisation, decelerate back to frugality and competing tensions or overrun the runway altogether in a devastating and irreversible crash. Similarly Larson (2011) writes: “the metaphors we adopt today have significant repercussions for our current and future approaches to environmental sustainability”. Perhaps the most powerful metaphor of all was the invocation of Spaceship Earth popularised by Buckminster Fuller and evoking the imperative of dependence on resources with finite limits.

5. Classroom exercises to communicate Sustainable Development needs

The above discussion has focussed on the twin imperatives of engineers being able to identify and counter mis-information and face up to deniers who use fake news to support inaction or dismiss urgent realities, and to develop skills of persuasion themselves that engage beyond merely evidence based rational arguments their discipline encourages. Irish (2016) points to three important aspects: persuasion is an ability that can be learned; persuasion depends on an understanding of the audience; and an audience's persuadability changes depending on contextual situations .

These issues are beginning to be explored at Cambridge University with a series of classroom exercises and challenges developed for use on the MPhil in Engineering for Sustainable Development.

5.1 Exploring Worldviews

This activity is based on an exercise proposed by Irish (2016) at the University of Toronto designed to encourage students to develop a foundational understanding of their own world views. It is a highly personal activity which require sensitive handling but with students drawn each year from over 20 countries this can be a rich resource to explore how individuals have constructed their internal belief systems. Understanding this can help clarify their own motivations and be more empathetic towards the motivations of others. Irish captures the importance of this, stating “It is the subjective foundation that allows us objectivity; it is the objective basis of our being which enable our individual and collective subjectivity. It is our lens through which the world is seen. Yet for most of us, its basis and origins lie entirely unexamined”

The MPhil programme has always asked volunteers to present to the group their own **personal stories**, relating to what they had done prior to coming to Cambridge. This is now nuanced by asking them to think about and share (if they are willing) their responses to three questions (Irish (2016) :

1. Where do I come from – what are the experiences factors, influences that make me who I am?
2. How do I see the world as a result of these influences (or in resistance to them?)
3. How does my world view impact my interaction with the world?

This is still in the early stages and needs further refinement but the process of encouraged shared self reflection provides a rich educational experience, both for the individual and the group as a whole. Having students who can critically assess their own world view and understand the power this can give them is an important step in how they can operate within rhetorical situations. Formality is kept to a minimum and anyone not feeling willing to participate is excused, whilst listening to what emerges from their colleagues

5.2 The power of structured debate

Another activity regularly featured on the ESD MPhil programme is an annual class debate, usually around a motion proposed by the student such as “ This house believes de-growth is the only way of achieving sustainable development” or “ Nuclear power is the solution to all energy created problems in the 21st century”. A refinement to this is asking each proponent/opponent and seconder to craft their arguments based entirely on either logos, pathos or ethos. (This is similar to other activities elsewhere in the programme which require students to advocate for a piece of infrastructure based on teleological, utilitarian, or deontological ethical positions).

5.3 Pitching for Sustainability

The third activity arose directly out of our of student feedback, when training was requested on how to provide a 1-2 minute pitch for sustainability to convince a sceptic. Again this existing activity has been modified to incorporate all three aspects of Aristotolean rhetoric incorporating elements of logos, ethos and pathos and to be even more challenging, students are asked to develop a metaphor to initially engage the listener. Working in small groups students make their pitches to the whole class, and their approach is collectively unpacked through subsequent discussion and its effectiveness analysed.

5.4 Open and closed minds

A final activity is to critique the approach of two presenters of a BBC documentary (“The Great American Oil Spill”) who explore the aftermath of the Deepwater Horizon oil spill disaster in 2010. Originally used to contrast the differences between an open minded approach and one driven by preconceived conceptions seeking blame, the discussion is now extended to identify how each presenter balances the use of pathos, logs and ethos in their commentary

All these activities are informal and not assessed and delivered through a supplementary programme of games, change challenges, simulations and role plays as a means of placing students in a situation where they must empathise with other perspectives. For them to work the skill lies in the quality of debrief and reflection afterwards, for which sufficient time must be set aside. Student feedback has usually pointed to this being an enriching experience and a good counterpoint to more formal studies and assignments.

6. Conclusion

Ahern (2000) argued that if engineering is to be discerned in its full complexity, an engineering voice needs to be developed. We argue here that engineers need to develop a voice both as honest brokers for sustainable development, and for spotting and responding to fake news and mis-information. This will be uncomfortable for many, but is a vital skill given the urgency of actions that need to be taken, where successful persuasion becomes critical.

What is clear is the fundamental pre-requirement to achieve this kind of discourse is imagination and creativity and a willingness to play an active role in the increasingly urgent debate.

References

1. Ahern A/L/ (2000) Words fail us: the pragmatic need for rhetoric in engineering communication *Global Journal of Engineering Education* Vol 4, No 1. Pp 57-64
2. Aldrich D.P., Meyer M.A (2015) Social capital an community resilience *American Behavioural Scientist* 59 pp 254-269
3. Andersen R., Curtis LJ (2012) The polarising effect of economic inequality on class identification: Evidence from 44 countries. *Research in Social Stratification and Mobility* Vol 30 pp 129-141
4. Booth W (1962) The rhetorical stance. *College Composition and Communication* 14 (3) pp 139-145
5. Chan M.S., Jones C.R, Jamieson K.H., Albarracin (2017) ‘Debunking: A meta-analysis of psychological efficacy of messages countering mis-information . *Psychological Science*, Vol 28 Issue 11 pp 1531-1546
6. Donner S.D, (2014) Finding your place on the science -advocacy continuum: An editorial essay. *Climate Change*, 124 pp1-8

7. Dunlap R.E McCright A.M., Yarosh J.J. (2016) The political divide on climate change: partisan polarisation widens in the US Environment: Science and Policy for Sustainable Development, Vol 58 pp 4-23
8. Gordon-Smith E (2019) Stop being reasonable. Scribe Publications, London UK
9. Grant A.J. (2019) Ethos, Pathos, and Logos: rhetorical fixes for an old problems: fake news. Proceedings of the Informing Science and Information Technology Conference June 30-July 4, Jerusalem, Israel
10. Hamilton L.C. (2015) Conservative and liberal views of science: does trust depend on topic. Regional Issue Brief 45 University of New Hampshire
11. Haythorn C., (2019) Aristotle and fake news :why understanding rhetoric illuminates credible arguments Available at: <https://medium.com/@HussainAther/guest-post-aristotle-and-fake-news-why-understanding-rhetoric-illuminates-credible-arguments-7c70c93b1a5d>
12. Irish R. (2016) Engineering Persuasion: teaching rhetorical savvy for engineering leadership Proceedings of Canadian Engineering Education Association (CEEA16) Conference Dalhousie University, Canada, June 19-22, 2016
13. Karlsson R (2015) Three metaphors for sustainability in the Anthropocene. The Anthropocene Review · August 2015 (Sage)
14. Kotcher J.E., Myers T.A., Vraga E.K./, Stenhouse N., Maibach E.W (2017) Does engagement ion advocacy hurt the credibility of scientists? Results from a randomised national survey experiment . Environment, Communication. 11, pp 415-429.
15. Lewandowsky S., Ecker U.K.H., Cook J., (2017) Beyond misinformation: understanding and coping with et “Post-Truth” Era. Journal of Applied Research in Memory and Cognition Vol 6 pp 353-369
16. Lewandowsky S., Ecker U.K.H., Seifert C., Schwarz N., Cook J., (2012) Misinformation and its correction: continued influence and successful debiasing . Psychological Science in the Public Interest 13 pp 106-131
17. McCright A.M. Charters M., Dentzman K., Dietz T. (2016) Examining the effectiveness of climate frames in the face of a climate change denial counterr-frame” Topics in Cognitive Science Vol 8 pp 76-97
18. McCright A.M., Dunlap R.E (2017) Combating Misinformation Requires Recognising Its Types and the factors that facilitate its spread and resonance Journal of Applied Research in Memory and Cognition Vol 6 pp389-396
19. Mitchell C.A., Carew A.J., Clift R. (2004) The Role of the Professional Engineer and Scientist in Sustainable Development Chapter 2 Sustainable Development in Practice: Case Studies for Engineers and Scientists Edited by Adisa Azapagic, Slobodan Perdan and Roland Clift John Wiley & Sons, Ltd
20. Scheufele D.A., Krause N.M. (2019) Science audiences, misinformation, and fake news. Proceedings of National Academy of Sciences, Vol 116, No 16, pp 7662-7669
21. Thaler R.H. Sunsten C.T (2008) Nudge: Improving decisions about health, wealth and happiness New Haven C Yale University Press
22. Varpio L. (2018) Using rhetorical appeals to credibility, logic and emotions to increase your persuasiveness Perspectives on Medical Education Vol 7 pp 207-210
23. WEF (2013) World economic Forum: Outlook for the global agenda 2014 (<http://reports.weforum.org/outlook-14/>)
24. Wright P.L/. (19723) The cognitive process mediating acceptance of advertising. Journal of Marketing Research 10 (1) pp 53-62

The Barcelona Declaration revisited: core themes and new challenges

Richard Fenner and David Morgan

¹Department of Engineering, Cambridge University, Cambridge , UK

raf37@cam.ac.uk

dcm32@cam.ac.uk

Abstract

The 2004 Barcelona Declaration is briefly reviewed and gaps reflecting current thinking around sustainability are identified. We ask is the Barcelona Declaration still fit for purpose, and what can be added or amended to reflect new trends and challenges that should be the over-riding concern of all responsible engineers? Our aim is to stimulate a debate so that EESD 20 can collectively agree to update a new version of the Declaration which reflects with urgency the growing emergency we face. We identify 9 dimensions which are not explicitly reflected in the original Declaration and propose 6 new competences which might be added to reflect how the drivers behind engineering education for sustainable development must reflect an understanding of six imperatives: values, context, uncertainty, change, limits and vision.

1 Introduction

The 2nd International Conference on Engineering Education for Sustainable Development in 2004 issued a call to engineering educators to produce a different kind of engineer with a broader understanding of complex issues and who would be guided by a longer-term, systemic approach and ethical considerations in decision making (see Appendix A) . Known as the Barcelona Declaration it has been referred to many times in succeeding Conferences and its spirit was evoked in Philadelphia in 2018 (e.g Martinez et al (2018)) at the ninth EESD gathering. Recent international reports remind us that we are facing a climate emergency (ipcc, 2018), huge losses of biodiversity through unprecedented rates of species extinction (IPBES 2019), a global water crisis, increased hazards from extreme events (World Economic Forum 2019) and dangers of mass population movements including the trend to urbanisation (World Economic Forum 2017). Situations that were urgent in 2004 are now becoming critical, with warnings that humanity has around 12 years to enact the changes needed to save the planet. So is the Barcelona Declaration still fit for purpose, and what should be added or amended to reflect new trends and challenges that should be the over-riding concern of all responsible engineers?

There is little wrong with the Declaration calling as it does for engineers to understand how their work interacts with both society and the environment, and how it impacts in different cultural, social and political contexts. Calling for multi-disciplinary teams, much has been achieved since 2004 to adapt technology to ensure resource efficiency, pollution prevention and waste management (e.g Prasad and Shih, 2016) with principles of the circular economy becoming central to many engineering operations. Its plea to move beyond the tradition of breaking reality down into disconnected parts, borne out of a Newtonian Science tradition of problem solving, and to listen closely to demands of citizens, was

arguably ahead of its time. This is now recognised in many engineering institutions where the technical fix can only achieve partial solutions to the wicked problems facing all communities and societies.

Drawing on the Barcelona Declaration, Segalas et al (2018) proposed a Sustainability Competency Map identifying four skills essential to develop in all engineering graduates. These include: critical contextualisation of knowledge; sustainable resource use and prevention of negative social and environmental impacts; participation in community processes; and application of ethical principles. These aspects of sustainability are helpfully related to the need for knowledge, understanding and application supported by specific descriptors of how this might be achieved

But it is also striking what the Declaration does not say, raising the question whether these competences are enough. For example there is no mention in the Declaration of climate, limits, growth, population, uncertainty or even the basic services needed by everyone for survival, and the tradeoffs which may have to be made in meeting these. Nor is there any sense of a future vision which can act as tangible goals for the next generation of engineers to work towards. More recently sinister forces have appeared in the form of popular denial of expert knowledge and understanding in a world which is increasingly polarised into seemingly irreconcilable viewpoints. A complete embracing of the spirit of the Barcelona Declaration is not enough in a world where the careful gathering of evidence is no longer respected as the basis for being “right” about a problem and where inconvenient truths are dismissed as fake news. Mitchell, Carew and Clift (2004) saw engineers as honest brokers, and a critical skill for future engineers is to go beyond being merely scientifically correct on an issue but to engage in ways that are more empathetic in communicating solutions that are rooted in rational analysis.

It is not the purpose of this paper to re-write the Barcelona Declaration, but to stimulate a debate so that EESD 20 can collectively agree to update a new version which reflects with urgency the growing emergency we face. Some issues which may have a bearing on this discussion are described in the following sections and we are sure others will emerge that are not identified here. Segalas et al (2018) analysed the key themes expressed in 600 papers delivered over 8 EESD conferences. They found topics that had declined were environmental design, LCA and management and policy, whilst transdisciplinarity, circular economy, and ethics and philosophy had increased. They also concluded that EESD was not happening at the pace it should in many Universities despite initiatives to promote integrating sustainable development in higher education (Lozano et al 2015; Ramos et al 2015). Lazzarini and Perez-Foguet (2018) point to the commodification of higher education as a barrier and impediment to a clear institutional commitment to the Barcelona Principles with university rankings (and the metrics which underlie these) becoming increasingly more important for measuring universities global competitiveness.

It is clear that many are still coming to the debate for the first time with Wilson (2019) (citing evidence nearly a decade old) boldly claiming that “most engineering programs do not explicitly prepare students to engineer within the bounds of sustainability”. So it is worth reflecting on what, in some cases, is being discovered for the first time, and ask are the notions of sustainability as expressed 16 years ago still fit for purpose, if they are to guide how engineering education for sustainable development is adopted, developed and delivered? There is a need to move beyond the (implicitly balanced) triple bottom line simplification of sustainability to more nuanced arguments which directly address the concerns raised above, and as Wilson calls for, build skills to address the major challenges that face engineers in the 21st century such as responding to the full range of Sustainable Development Goals (Leal Filho et al, 2019).

2 Missing dimensions of the Barcelona Declaration

2.1 Uncertainty, Avoiding Technical Lock-In and Adaptation Planning

We live in very uncertain times, ranging from instabilities emerging in our political systems to the extent of impacts from climate change and the consequences of interfering with the global ecosystem. Uncertainty arises in many ways, such as from inherent *unpredictability* of systems, *incomplete knowledge* of system responses, and multiple legitimate, and often competing, *knowledge frames* and world views of stakeholder groups which influence how problems are perceived and defined.

Managing that uncertainty will increasingly be required by engineers. This has been achieved in the past through large infrastructure projects where technical precautions smooth out environmental variabilities; examples include providing shelter, flood protection, drought mitigation, pollution prevention and so on. However we don't live in a static system, with step changes becoming apparent away from the trends we can discern in the historic record. This means predicting and planning for an uncertain future is extremely difficult, as decisions made now may have huge impacts - and the propensity to get things wrong is very high. Effectively operating under this uncertainty will be a cornerstone of how future engineers deliver their services, and they should always retain flexibility in the solutions they propose.

It is essential that future engineers avoid the trap of creating a technical lock-in to inflexible solutions, often manifest as large infrastructure projects such as the Thames Tideway Tunnel in London, which comes with a very high cost burden (and carbon footprint) and may no longer be fit for purpose in just a few years time. This requires a paradigm shift from a "design and defend" or "predict and control" mindset which implicitly conveys a false sense of security, to an approach which follows the principles of adaptation planning.

Adaptive pathways are becoming more widely used by keeping a range of alternative options open so a wide variety of relevant uncertainties can be explored. Short-term targets are connected to long-term goals over time, commitment is made to short-term actions while retaining flexibility to move to alternative pathways as new information and understanding becomes available, and the world is continuously monitored and actions taken when required performance standards can no longer be met (Walker et al, 2013). Examples of this approach have been given by Kosmielja and Paslawski (2015) in relation to road schemes in Poland; Wirkus (2016) in relation to railways and by Hall et al (2019) who explore pathways for tidal flood risk management in London based on the adaptation options identified by the Thames Estuary 2100 project (Bloemen et al, 2018).

2.2 Respecting planetary boundaries and stakeholder positions

Engineering is constrained by the finite resources it both consumes and needs to protect. Engineers will have to quickly learn how to work within increasingly stringent carbon budgets and wider resource scarcity. In short, they will need to do more with less in ways that meet the changing societal behaviours, pressures and expectations. These are changing far more rapidly than in the past, as seen recently in the public's changing attitudes to plastics. Engineers will have to modify future operation accordingly as these are redefined against new (and perhaps unexpected) pressures, as the criteria by which successful projects are judged will radically change. This requires another paradigm shift away from building and manufacturing solutions to meet societal wants but responding with minimum interference to meet

essential needs. This can be partly achieved by following the sustainability hierarchy in Figure 1, where the preferred option is to reduce demand and make existing assets more productive with large engineering solutions only considered as a last resort

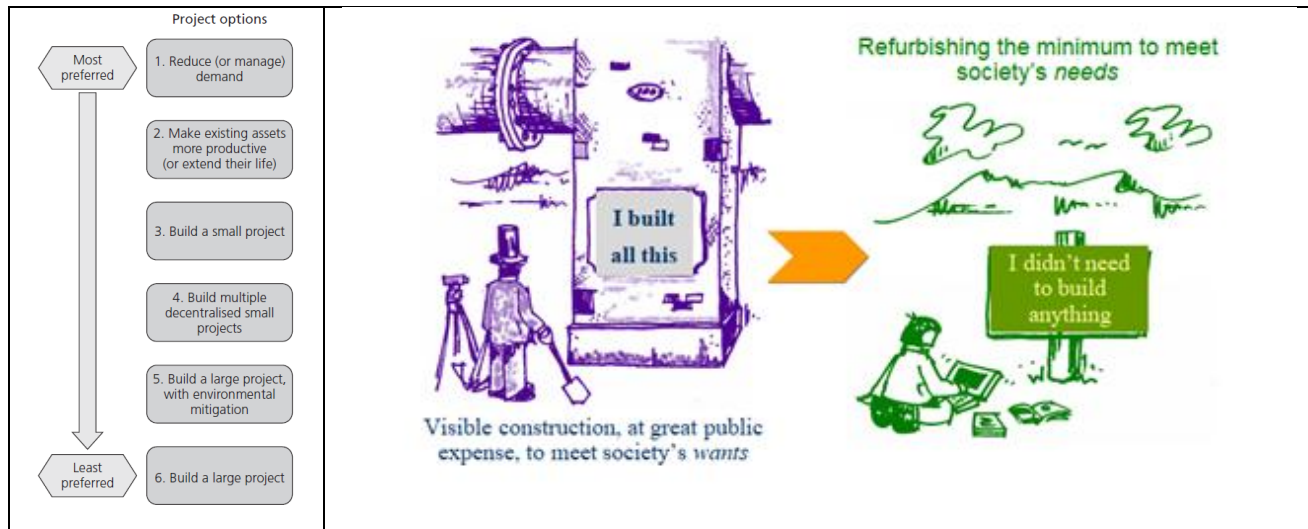

Figure 1 : A sustainability hierarchy and a change in engineering culture (after Ainger and Fenner 2014)

This fundamentally challenges many aspects of our current engineering culture, in which much of our job satisfaction comes from building and making things. New skills and education, coupled with new business models, are needed to achieve this so environmental limits are respected and society's needs are met, but wider wants such as cheap unlimited air travel are restrained/

2.3 Delivering change against a future vision

Meadows, Meadows and Randers (2004) believed that “ a sustainable world can never be fully realised until it is widely envisioned, while accepting that vision without action is useless and needs to be disciplined by scepticism”. It is important is to possess the vision that improvements in the quality of environment, social fairness and economic prosperity can be sought through change. But Prince Charles (2012) observed in a direct address to engineers: “So much of modern (engineering) thinking seems to have ignored the importance of looking to the long term”. The process of working with scenarios directly aids broader thinking, stimulates new ideas and assists in shaping how new interventions can be implemented.

The Infrastructure Transitions Research Consortium (<https://www.itrc.org.uk/>) recognised it is not possible to design a subsystem as complex as civil infrastructure, decades in advance with a specified strategy for phased implementation where many adaptations will be needed in the intervening years. Nevertheless such systems don't arise spontaneously and need strategic intent, so that “the pathways for reaching sustainable end points from the current stateneed to be set now” (Hall et al, 2013). Engineers need to look far enough ahead so as not to be constrained by current barriers and mindsets. Always asking “where do we want to be 50 years from now” can help focus on long term sustainable objectives.

2.4 Resilience

Some are beginning to argue that concepts of sustainability have proven too hard to deliver in engineering practice and parts of the engineering industry has moved on to simpler and more tractable terms such as resilience (Ashley et al, 2020). This is often referred to in relation to infrastructure systems but often misconstrued as simple durability.

But “Resilience” doesn’t have a generally consensual definition. Key features of engineering resilience are the resistance to disturbance and the speed of return to equilibrium. Other formulations refer to ecological resilience which sees resilience in a more dynamic way where the capacity to absorb the magnitude before changing its structure is the main feature (Bertillson et al, 2018). Holling (1996) stresses that engineering resilience focuses on efficiency, constancy and predictability while ecological resilience focuses on persistence, change and unpredictability.

Abdulkareem and Elkadi (2018) provide a thorough discussion of the different forms of resilience contrasting the engineering fail-safe approach with the ecological safe-to-fail response, which has a profound implication for how engineers are trained in engineering design.

2.5 Responding to wicked problems

The world is fundamentally messy with many problems not amenable to the technical fix which much of engineering education promises. Indeed many challenges may be intractable in terms of a “right” or “wrong” solution which a reductionist education traditionally seeks. Lonngren, Ingerman and Svanstrom (2017) suggest current educational practice may not adequately prepare students to deal with such problems. In an often cited quote, Schon (1987) contrasts the high hard ground of manageable problems with “the swamp wherein lie the problems of greatest human concern”. Educating engineers to operate effectively in this swamp is fundamental if elegant, sophisticated and difficult solutions are ever to be accepted and implemented in the real world.

These problems are often emergent properties of complex systems and arise because understanding the system behaviour cannot be reconciled to a single perspective but have to be understood through multiple legitimate and often competing viewpoints. However such complexity should not be looked at as something nasty that has to be reduced or avoided, but accepted as a pre-condition for innovation and transition (Geldof and Stahre, 2006).

2.6 Fit for purpose solutions (context)

Engineering for Sustainable Development is not a prescriptive science. It can’t be treated like a Code of practice, where if stringent guidelines are followed a sustainable solution will emerge at the end of the process. A greater skill is asking a wider set of question which expose the context within which the engineering solution must be delivered. Davide Stronati (2017) points to a fundamental misunderstanding in arriving at sustainable solutions where the sustainability approach may be the same across different projects *but the solutions are not*, as these must emerge from highly specific local contexts. This view is reinforced by Rogers (2012) who states “What is sustainable is determined locally”. This requires an ongoing strategic engagement with many different stakeholders and constant dialogue with all the teams delivering an engineering project. In this way sustainable solutions will effectively emerge, in ways acceptable to all parties that result in a higher chance of successful implementation.

2.7 Handling tradeoffs

A fundamental fallacy of sustainable development is the apparent balance which the classic Venn diagram of equally weighted social, environmental and economic domains implies. This looks pleasingly neat on the page but necessarily unattainable in practice. Tradeoffs will always be necessary and some issues require more weight than others, such as the fundamental protection of Natural Capital in the strong sustainability interpretation of the 5 capitals model (<https://www.forumforthefuture.org/the-five-capitals>).

If we extend the criteria by which engineering is assessed then ways of handling this multi-dimensional and interdisciplinary complexity need to be applied. In an LCA for example, simply incorporating more impact categories may result in confusion, unless it is understood how some categories may have more importance, significance and relevance to the problem

Multi-criteria analysis and negotiation skills become essential tools in the engineer's toolkit. This may require a diversion into the realms of subjectivity (judgement and opinion) which leave many classically trained engineers uncomfortable because their objective view of the world may be challenged.

2.8 Persuading the sceptics and deniers

McDonough and Braungart (2013) argue that sceptics and deniers are one of the greatest assets available in delivering sustainable development, as once converted and on-side they can become the most powerful advocates for change. However, whereas arguments used to be underpinned simply by the sheer weight of supporting evidence, this is now no longer enough in a world of post-truth and misinformation and experts are frequently simply derided (such as the entire UK Environment Agency by senior Government ministers). This perhaps is one of the biggest and most insidious changes since the Barcelona Declaration was formulated in 2004. For engineers to articulate sustainable responses they need to go beyond just being merely "right" about whatever issues they are dealing with but to engage using communication skills that also engage the emotional and moral characteristics of their professional and public audiences. Equipping the next generation of engineering graduates with this skill may prove to be the most important education challenge of all

2.9 Values

Sustainability remains a contested concept and is value based. But negotiating shifts in values via indoctrination in lecture based environments is prone to failure, and instead requires more student centred learning strategies, including problem based learning, experiential learning, participatory learning, and applied learning (Wilson 2019). Whilst previous generations have focused on the logos component of Aristotolean rhetoric, increasingly the ethos and pathos are rising to the fore and these can be guided by professional and personal commitment to genuine improvements which positively benefit the environment and society. Most engineers would want their work to be worthwhile, but articulating a specific position (e.g on climate change) can help provide a touchstone by which all subsequent actions and decisions can be tested.

3. Conclusions – new competences are needed

In many ways the drivers behind engineering education for sustainable development lie in an understanding of six imperatives: values, context, uncertainty, change, limits and vision. This provides clues regarding what might be added to a revised version of the Barcelona Declaration that may emerge

from this Conference. But also challenges are beginning to emerge which question the prevailing approaches to sustainability which are essentially based on a belief that sustainability can be delivered by exploiting nature in a smarter way and controlling it better based on faith in individual behaviour changes and technical fixes (Horton and Horton, 2019). More radical views on how transitions to sustainability might happen need also reflecting in the Declaration, based on living in harmony with life on earth and not dominating it. A challenging approach to sustainable development itself is necessary to avoid complacency. This requires an understanding why some have seen sustainable development as an empty idea containing within it the seeds of further environmental, human, and social degradation, where technical fixes inherently don't work, and calling for an ontology of care to replace the current ontology of need (Ehrenfeld, 2008).

The Declaration is explicit about the educational processes that should be reviewed and calls for institutional commitments, which still need strengthening further in the context of the emergency we face, so Universities become agents for change. The Declaration mentions "universal values" without defining what these might be and recognises the importance of evaluating the contribution of engineering activity in a wide range of contexts.

In concluding we propose the following as a starting point for further discussion which explicitly add new themes to what is already included in the Barcelona Declaration:

- Values:** to develop commitments to environmental protection and human development through contributing to the achievement of the SDGs.
- Context:** to connect local, regional and global concerns and systems so problems are framed against real world constraints
- Uncertainty:** to retain flexibility to adjust through frequent reappraisal and adaptation.
- Change:** to challenge orthodoxy and seek innovation.
- Limits:** to test all engineering decisions against their impact on planetary health (with respect to climate change, biodiversity loss, resource depletion) and societal well-being, (with respect to poverty, dignity and human rights) so as to maintain socio-ecological integrity of the planet.
- Vision:** the ability to formulate an anticipatory view of the future and to act within the precautionary principle , through strategic thinking.

Of course whilst this discussion revisits what should be taught in engineering education, it does not address *how* this should be done, and we acknowledge many aspects of good practice where these competencies are being effectively developed through novel pedagogies and inspiring leadership amongst educators (Leal Filho and Nesbitt, 2016).

We close by highlighting the need to deliver this agenda within a rapidly diminishing window of opportunity, and this urgency provides an over-riding context for this paper. This urgency also applies with respect to the world of engineering decision making and management students will be entering. The vast majority of engineers who will be practicing and leading engineering projects through this window are already in post, so how can the University sector support Continuing Professional Development in this area? What should be prioritised in university curricula in the coming years? And finally what does the urgency of the challenge imply for EESD?

References

1. Abdulkareem M, Elkadi H., (2018) From engineering to evolutionary, an overarching approach in identifying the resilience of urban design to flood. *International Journal of Disaster risk reduction* Vol 28 pp 176-190
2. Ashley R., Gersonius B., Horton B (2020) *Managing water – from problem to opportunity*. Royal Society Philosophical Transactions A forthcoming special edition on Urban Flood Resilience
3. Bertillon L., Wiklund K., de Moura Tebaldi I., Rezende O.M., Verol A.P., Miguez M.G. (2018) Urban flood resilience - a multi criteria index to integrate flood resilience into urban planning. *Journal of Hydrology*
4. Bloemen P., Reeder T., Zevenbergen C., Rijke J., Kingsborough A. (2018) Lessons learned from applying adaptation pathways in flood risk management and challenges for the further development of this approach *Mitigation and Adaptation Strategies for Global Change* (2018) Vol 23 Issue 7:1083–1108 <https://doi.org/10.1007/s11027-017-9773-9>
5. Ehrenfeld J (2008) *Sustainability by Design* Yale University Press. New Haven and London
6. Geldof G., Stahre P. (2006) On the road to a new stormwater planning approach: from Model A to Model B *Water Practice & Technology* Vol 1 No 1 © IWA Publishing 2006 doi: 10.2166/WPT.2006005
7. Hall J.W., Harvey H., Mannig L.J. (2019) Adaptation thresholds and pathways for tidal flood risk management in London. *Climate Risk Management* 24 (2019) pp 42–58
8. Holling C.S (1996) engineering resilience versus ecological resilience In Shultze P.C., (ed) *Engineering within Ecological Constraints*, National Academy Press, Washington Dc, USA
9. Horton P., Horton B.P (2019) Re-defining Sustainability: Living in harmony with Life on Earth. *One Earth* 1 (Elsevier) September 2019 pp 86-93
10. HRH Prince Charles (2012) Working in harmony with nature: the key to sustainability *Proceedings of the Institution of Civil Engineers - Civil Engineering* 165 Issues CE 3 pp 123-128 <https://doi.org/10.1016/j.crm.2019.04.001>
11. IPBES (2019) *Global Assessment Report . United Nations Summary for Policy Makers* available at: https://www.ipbes.net/sites/default/files/downloads/spm_unedited_advance_for_posting_htn.pdf
12. IPCC (Intergovernmental Panel on Climate Change)(2018) *Global warming of 1.5 degrees* WMO UNEP ISBN978-92-9169-151-7 (Available at: https://www.ipcc.ch/site/assets/uploads/sites/2/2018/07/SR15_SPM_version_stand_alone_LR.pdf
13. Kośmiejka M. and Paślowski J (2015) Flexible approach in designing infrastructure. *Procedia Engineering* Vol 122 (2015) pp 104 – 111 <https://doi.org/10.1016/j.proeng.2015.10.013>
14. Lazzarini B and Perz-Foguet A (2018) Profiling research of academics who successfully promote education in Sustainable Human Development. *Journal of Cleaner Production* 172 4239-4253
15. Leal Filho W., Shiel C., Paco A., Mifsud M., Veiga Avila L., Londero Brandi L., Molthan-Hill P., Pace P., Azeiteiro U.M., Ruiz Vargas V., Caerio S., (2019) Sustainable Development Goals and sustainability teaching at universities: Falling behind or getting ahead of the pack? *Journal of Cleaner Production* pp 285-294
16. Leal Filho W., Nesbitt S. (eds) (2016) *New Developments in Engineering Education for Sustainable Development* Springer International Publishing Switzerland 2016
17. Lonngren J., Ingreman A., Svansrom M. (2017) Avoid, Control, Succumb, or Balance: Engineering Students' Approaches to a Wicked Sustainability Problem *Res Sci Educ* (2017) 47:805–831

18. Lozano R., Ceulmans K., Alonso-Almeida M., Huisingh D., Lozano F.J., Waas T., Lambrechts W., Lukman R., Hoge J., (2015) A review of commitments and implementation of sustainable development in higher education: results from a worldwide survey *Journal of Cleaner Production* , 108 , 1-18
19. Martinez E., Rogers R., Raby L., Baker P., Satreke J., (2018) Environmental Engineering for Community Development- Engineering Design for Non-Engineering majors Proceedings of 9th International Conference on Engineering Education for Sustainable Development Rowan University, New Jersey, June 2018
20. McDonough W and Braungart M (2013) *The Upcycle – Beyond Sustainability Designing for Abundance.* Strauss and Giroux, New York, NY, USA
21. Meadows D., Meadows D. and Randers J. *Limits to Growth— the 30-year Update.* Chelsea Green Publishing, Vermont, 2004.
22. Mitchell C.A., Carew A.J., Clift R. (2004) *The Role of the Professional Engineer and Scientist in Sustainable Development Chapter 2 Sustainable Development in Practice: Case Studies for Engineers and Scientists* Edited by Adisa Azapagic, Slobodan Perdan and Roland Clift John Wiley & Sons, Ltd
23. Prasad M.N.V , Shih K. (eds (2016) *Environmental. Materials and Waste: Resource Recovery and Pollution Prevention .* Academic Press, Elsevier (doi.org/10.1016/B978-0-12-803837-6.01001-5)
24. Ramos T.B., Caeiro S., van Hoof B., Lozano R., Huisingh D., Ceulmans K. (2015) Experiences from the implementation of sustainable development in higher education institutions: environmental management for sustainable universities. *Journal of Cleaner Production* 106 3-10(2015).
25. Schön, D.A. (1987), *Educating the Reflective Practitioner: Toward a New Design for Teaching and Learning in the Professions*, San Francisco: Jossey-Bass
26. Segalas J., Carracedo F.S., Hernandez A., Busquetst P., Tejedor G., Horta R.(2018) The EDINOST project. Training sustainability change agents in Spanish and Catalan Engineering Education. Proceedings of 9th International Conference on Engineering Education for Sustainable Development Rowan University, New Jersey, June 2018
27. Segalas J., Drijvers R., Tijseen J., (2018) 16 years of EESD. A review of the evolution of the EESD conference and its future challenges. Proceedings of 9th International Conference on Engineering Education for Sustainable Development Rowan University, New Jersey, June 2018
28. Stronati D. (2017) Fact. Sustainability professionals don’ have all the answers . ICE The Civil Engineers blog (See: <https://www.ice.org.uk/news-and-insight/the-civil-engineer/november-2017/fact-sustainability-professionals-dont-have-all>
29. Walker W., Haasnoot M., Kwakkel J.H. (2013) Adapt or Perish: A Review of Planning Approaches for Adaptation under Deep Uncertainty. *Sustainability* 2013, Volume 5, pp 955-979; doi:10.3390/su5030955
30. Wilson D (2019) Exploring the Intersection between Engineering and Sustainability Education *Sustainability* 11 2019 doi: 10.3390/su11113134
31. Wirkus M. (2016) Adaptive management approach to an infrastructure project *Procedia - Social and Behavioural Sciences* Volume 226 (2016) pp 414 – 422
32. World Economic Forum (2017) *Migration and Its Impact on Cities* World Economic Forum 91–93 route de la Capite CH-1223 Cologne/Geneva Switzerland (available at: http://www3.weforum.org/docs/Migration_Impact_Cities_report_2017_low.pdf
33. World Economic Forum (2019) *Water scarcity is one of the greatest challenges of our time* Available at: <https://www.weforum.org/agenda/2019/03/water-scarcity-one-of-the-greatest-challenges-of-our-time/>

Appendix A

EESD Barcelona Declaration (Final Version, October 2004)

Settled at the 2nd International Conference of Engineering Education for Sustainable Development

Preamble

We live in an increasingly complex world and we are at a critical juncture at which humanity must make some serious choices about the future. Our current model of development poses significant challenges when it comes to achieving a more just society based on respect for nature and human rights, and demands a fairer economy and greater solidarity towards different cultures and future generations.

Ignoring this reality when educating and informing future citizens, and therefore future professionals, could have severe consequences. It is undeniable that the world and its cultures need a different kind of engineer, one who has a long-term, systemic approach to decision-making, one who is guided by ethics, justice, equality and solidarity, and has a holistic understanding that goes beyond his or her own field of specialization.

Education supports a process of self-discovery and learning about the world, encourages personal development, and helps individuals find their roles in society. However, education is also a commitment to improving society by strengthening communities and stimulating social progress. This reality forces us to reconsider the purpose of our role as social actors, in particular as educators, and to construct a way of responding to these challenges.

Education, and particularly higher education, is a vital tool to be used for facing today's challenges and for building a better world. Higher education is essential if we are to achieve sustainable development and therefore social progress. It also serves to strengthen cultural identity, maintain social cohesion, reduce poverty and promote peace and understanding.

Higher education institutions must not restrict themselves to generating disciplinary knowledge and developing skills. As part of a larger cultural system, their role is also to teach, foster and develop the moral and ethical values required by society. Universities need to prepare future professionals who should be able to use their expertise not only in scientific or technological context, but equally for broader social, political and environmental needs. This is not simply a matter of adding another layer to the technical aspects of education, but rather addressing the whole educational process in a more holistic way, by considering how the student will interact with others in his or her professional life, directly or indirectly. Engineering has responded to the needs of society and without a doubt, today's society requires a new kind of engineer.

/ continued

We declare that

Today's engineers must be able to:

- Understand how their work interacts with society and the environment, locally and globally, in order to identify potential challenges, risks, and impacts.
- Understand the contribution of their work in different cultural, social, and political contexts and take those differences into account.
- Work in multidisciplinary teams, in order to adapt current technology to the demands imposed by sustainable lifestyles, resource efficiency, pollution prevention and waste management.
- Apply a holistic and systemic approach to solving problems and the ability to move beyond the tradition of breaking reality down into disconnected parts.
- Participate actively in the discussion and definition of economic, social and technological policies, to help redirect society towards more sustainable development.
- Apply professional knowledge according to deontological principles and universal values and ethics.
- Listen closely to the demands of citizens and other stakeholders and let them have a say in the development of new technologies and infrastructures.

Engineering education, with the support of the university community as well as the wider engineering and science community, must:

- Have an integrated approach to knowledge, attitudes, skills and values in teaching.
- Incorporate disciplines of the social sciences and humanities.
- Promote multidisciplinary teamwork.
- Stimulate creativity and critical thinking.
- Foster reflection and self-learning.
- Strengthen systemic thinking and a holistic approach. Train people who are motivated to participate and who are able to take responsible decisions.
- Raise awareness for the challenges posed by globalization.

In order to achieve the above, the following aspects of the educational process must be reviewed:

- The links between all the different levels of the educational system.
- The content of courses.
- Teaching strategies in the classroom.
- Teaching and learning techniques.
- Research methods.
- Training of trainers.
- Evaluation and assessment techniques.
- The participation of external bodies in developing and evaluating the curriculum.
- Quality control systems.

These aspects cannot be reviewed in isolation. They need to be supported by an institutional commitment and all decision makers, in the form of:

- A redefinition of institutions' and universities' missions, so that they are adapted to new requirements in which sustainability is a leading concern.
- An institutional commitment to quality.
- An institutional support for changing educational paradigms and objectives research funding.

Universities must redirect the teaching-learning process in order to become real change agents who are capable of making significant contributions by creating a new model for society. Responding to change is a fundamental part of a university's role in society. There is evidence that sustainable development has already been incorporated in engineering education in a number of institutions around the world. The United Nations Decade on Education for Sustainable Development (2005-2014) offers a great opportunity to consolidate and replicate this existing good practice across the international higher education community.

Universities now have the opportunity to re-orient the traditional functions of teaching and research, by generating alternative ideas and new knowledge. They must also be committed to responding creatively and imaginatively to social problems and in this way educate towards sustainable development

Non-Discipline Specific Sustainability Knowledge & Competences in the Chemical Engineering Programme at UCC

John J. Fitzpatrick and Edmond P. Byrne

Process & Chemical Engineering, School of Engineering, University College Cork, U.C.C.

j.fitzpatrick@ucc.ie

Abstract

This paper is presented within the broader theme of considering what non-engineering-discipline specific sustainability / sustainability development (SD) knowledge and competences should be included in engineering education, in particular for four year undergraduate or four to five year integrated master's programmes. Over the last 20 years, sustainability / SD has grown in importance, and consequently many engineering programmes have endeavoured to integrate it within their programmes. The UCC chemical engineering is one of these programmes. The inclusion of sustainability / SD content inherently contains engineering discipline specific content, but also includes content that is non-discipline specific and could potentially be undertaken by any engineering student. This paper looks at the University College Cork (UCC) Process and Chemical Engineering programme, and outlines the content that is considered as non-discipline specific. This includes the following which are briefly outlined in more detail within the paper:

- Basic concepts in sustainability and SD: What is it all about? The importance of framing.
- The environmental dimension, ecological systems thinking and importance of ecological limits.
- The role of environmental legislation.
- Humanity's grand challenges; the food-energy-water nexus and climate change.
- The game-changer: The socio-economic dimension (including ecological economics); its essential role in transitioning to and maintaining a sustainable society; its impact on engineering and to what extent engineering can have influence on the socio-economic dimension.
- Holistic thinking; inherent interconnectedness, life cycle thinking and assessment.
- Energy, its importance and its commonality to all engineering disciplines, and beyond..
- Acquiring soft skills of critical thinking, communication, working with others, embracing uncertainty and complexity.
- Transdisciplinarity, emergent knowledge, and the need to be able to work with others outside our disciplinary "silo".
- Values, ethics and the normative nature of sustainability choices and narratives.
- Worldviews, paradigms, and links with consumptive growth (material, energy, information).
- Transformational change; going beyond the quantitative and reductionist and the role of narrative, imagination, myth and metaphor in precipitating authentic societal and cultural change.

Keywords: non-discipline specific; sustainability knowledge & competences; UCC Process and Chemical Engineering programme

1 Introduction

Sustainability and Sustainable Development (SD) have become increasingly more and more important over the past 30 years, particularly because of human-induced climate change, but also because of concerns about the sustainability of modern agriculture, fresh water supply for irrigation and loss of biodiversity. These have the worrying potential to threaten the future prosperity of humanity (and other species) and even the survival of many. The current dominant business-as-usual socio-economic paradigm appears unsustainable, and some fear it could lead to the collapse of the global economy and human well-being. Engineering is a technical discipline that has great scope for contributing to human well-being, and its ability “to make a difference to the world” is a major reason why students choose it as a career (Alpay et al., 2008). However, it could be argued that engineering and technology in themselves are not enough, and within the current dominant socio-economic paradigm, engineering and technology are only moving humanity faster along an unsustainable path, possibly towards collapse (Byrne & Fitzpatrick, 2009, Fitzpatrick, 2017). Yes, they may be producing benefits to humanity, but this may be only in the short-term, being ultimately unsustainable and detrimental to humanity in the longer-term. Consequently, we now need engineers who are aware of sustainability and the potential sustainability crisis. They can no longer be just “guns-for-hire” serving the current socio-economic paradigm.

Considering this context, we need to graduate engineers that are suitably equipped to contribute to the transition from our current unsustainable path to a sustainable vision. Ultimately, engineers require more than just technical / discipline specific competences. Yes, technical and discipline specific competences will always be essential and core to an engineer’s contribution to society. However, contemporary and future engineers require more, in particular non-discipline specific sustainability knowledge, mind-set and competences that enable them to make effective contributions to the transition to a sustainable society. This will encourage them to take a sustainability informed perspective into consideration when choosing career options post-graduation. They may have opportunities to integrate their sustainability informed education into their contribution to the decision making processes within their respective organisations as they progress through their careers. Some may become change-leaders, like the late Ray Anderson, an engineer and industrialist who was a pioneer in trying to incorporate sustainability into his business (Anderson, 2009).

This paper outlines the non-discipline specific sustainability knowledge & competences that are taught on the chemical engineering degree programme in University College Cork (UCC), along with rationale for including this content. It is hoped that this paper could contribute to a broader discussion on what non-discipline specific sustainability topics may be of value and importance to the education of engineers.

2 Non-discipline specific sustainability related content in UCC chemical engineering

This section briefly outlines the non-discipline specific content related to sustainability knowledge and competences and its rationale in the UCC Process and Chemical Engineering degree programme. This content is mainly undertaken in two bespoke modules in Sustainability and Environmental Protection which complements discipline specific (chemical engineering) content dealing with cleaner technology, waste treatment and disposal, life cycle analysis and environmental management.

2.1 Basic concepts in sustainability and SD

Firstly, students need an awareness and basic understanding of sustainability and SD. Thus it is important that students receive a basic grounding in these concepts. The word sustainability implies the ability to sustain. It therefore needs to be stated what it is that actually needs to be sustained when using the word “sustainability”. Framing too is important, not just of sustainability related issues and wicked problems, but of the concept of sustainability itself. For example, in the context of this paper, we envision sustainability as essentially relating to human flourishing: the “sustainability of human flourishing”, as stated by Ehrenfeld (2013). One way of defining this is that “sustainability” is all about large numbers of people (globally) being able to “flourish” over a “prolonged” period of time. Ehrenfeld argues that this vision of sustainability (as-flourishing) implies a positive, emergent, qualitative state, while “sustainable development” implies a negative, cutting back, quantitative, reductive approach which focuses on techno-efficiency, but cannot deliver on human flourishing. In practice however, the terms sustainability and sustainable development are often used interchangeably in practice. One way used to reconcile the two terms is that sustainability is seen as the goal, vision or where we want to go to, while sustainable development is envisioned as the “road” taken to achieve this goal. These and various other concepts and models of sustainability are explored and discussed.

2.2 The environmental dimension and ecological limits

It could be argued that environmental sustainability provides a foundation to sustainability more broadly considered, in the sense that humans need the environment to provide the natural resources and to deal with their wastes to facilitate human living and flourishing. For engineers, environmental sustainability is thus very important because engineers are involved with the use of raw materials extracted from nature and with the generation of wastes and emissions discharged into nature. It is very important therefore that engineers learn to view these activities from a sustainability perspective. It is important too that students are exposed to the negative impacts that humanity is having on the natural environment, while understanding the science of how that environment works, including interconnected ecosystems. Such “ecological systems thinking” is developed via a bespoke module on “Ecology for Engineers”, taken in second year.

It is useful to highlight the fact that nature manifests the concept of sustainability, as it has flourished over a prolonged period of time, and to explore some of the key features of how nature operates sustainably, including natural recycling of materials and use of solar energy. Environmental unsustainability can be viewed in terms of 1) unsustainable extraction of natural resources and 2) unsustainable discharges of emissions / wastes that “hurt” the environment (Figure 1). Consequently, there are ecological limits associated with resource extraction and discharge of wastes / emissions e.g. if a natural resource is extracted at a rate (mass flowrate) greater than it can replenish itself (ecological limit), then it is being extracted unsustainably and its capital stock will face depletion. Likewise, emissions are environmentally unsustainable if they are discharged at rates larger than that which nature can process them.



Figure 1: A schematic of environmental unsustainability.

2.3 Environmental legislation

Engineers need to be aware of and appreciate the role of legislation as a strong tool for reducing environmental impact by industrial firms and other organisations. Legislation is a particularly important environmental tool in a market economy, because organisations operating in a market economy need strong environmental legislation to reduce their environmental impact because their primary goal is to maximise profit. In Europe, EU directives are the major driver of environmental legislation and students are exposed to some key environmental directives and how they are implemented in an Irish context.

2.4 Humanity's grand sustainability challenges

It is important that students have an awareness and appreciation of the grand sustainability challenges facing humanity, and to instil in them a realisation that the negative impacts from not addressing these challenges may materialise during their lifetime, and thus could majorly impact on their lives sometime in the future. Some of the major sustainability challenges that are presented include

- Supply of the basic needs for living, in particular the food, energy, water (FEW) nexus
- Climate change and how it interacts and exacerbates the challenges associated with the FEW nexus.

Initially, students are exposed to the concept that humanity has moved into a space where it is living beyond ecological limits, as described by ecological footprinting and by the "Limits to Growth" study (Meadows et al., 2005). Humanity cannot indefinitely live beyond these limits and contraction will occur sometime in the future. This will either be through a "managed decline" to sustainable levels of activity, or "collapse" to the same levels, caused by the unmitigated work of "nature" or its impact on "the market".

The potential unsustainability of modern agriculture, its' ability to sustainably supply food and its impact on fresh water supply is a grand sustainability challenge which is presented to the students, with help of a book by Brown (2012). Brown uses the term the "food equation". On one side there is demand for food, and on the other side is the supply of food from agriculture that must satisfy the demand. There are pressures on agriculture from both sides of the food equation, as outlined in the Table 1, and these are presented and explained to the students.

Table 1: Pressures on agriculture

Demand side	Supply side
Increasing human population	Increasing soil erosion
Increasing affluence	Increasing water shortages
Biofuels	Increasing global temperature
	Plateauing of grain yields

Climate change and its interaction with energy are possibly the most urgent and pressing sustainability challenges, and the students have already some awareness of these. However, it is still important to spend time on these topics and explore them in detail. Global energy supply is still dominated by fossil fuels and the environmental unsustainability is explored with the students from both natural resource and carbon emission ecological limits, with the latter and its consequences for climate change being much more worrying and moving rapidly towards crisis levels. Technological approaches are considered for moving to

a sustainable global energy future. However, it is suggested and explored with the students that the real “game-changers” lie in the socio-economic domain, and that these have a major impact on the development and implementation of cleaner technology approaches.

2.5 Ecological economics and the socio-economic dimension

It could be argued that the economic and social levers for change are the “game-changers” in moving to a sustainable paradigm, and have a major influence on the technical levers. Consequently, the prevailing socio-economic paradigm needs to be modified to provide a framework which facilitates and incentivises engineers to deliver technological improvements to people’s well-being that are long-term, that is, they are sustainable, as schematically illustrated in Figure 2. Ecological economics can help engage students in the importance of the socio-economic dimension of sustainability, and how the socio-economic can influence engineering & the transition to the sustainability of human flourishing.

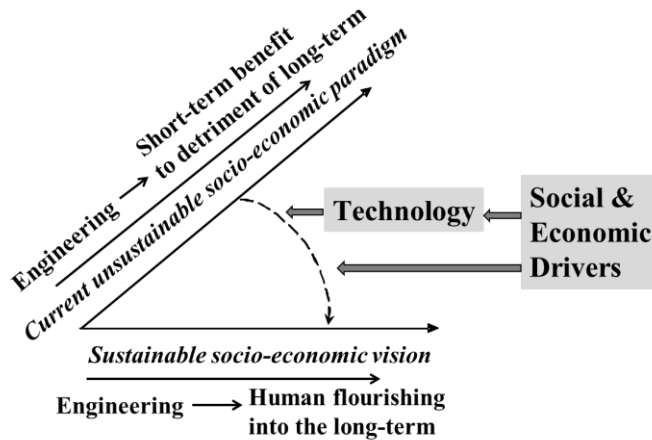

Figure 2: Moving to sustainable socio-economic paradigm that facilitates engineering to deliver technologies that enhance human flourishing in the long-term.

Its’ focus and premise is on an economic system that facilitates the sustainability of human flourishing within planetary limits. There are two broad elements to a sustainable economy, as illustrated in Figure 3 and outlined by Dietz & O’Neill (2013), that can facilitate the sustainability of human flourishing, namely: Environmental and Social, and these are explored in detail with the students.

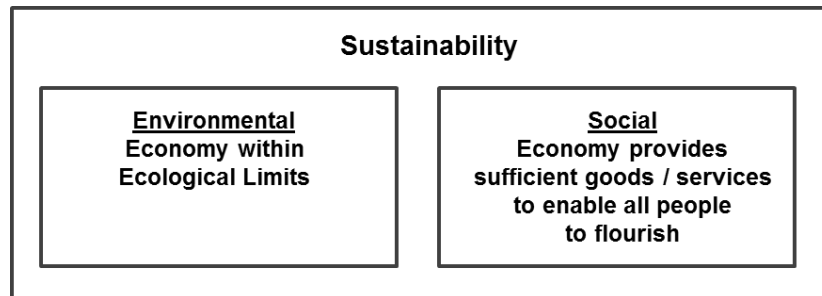

Figure 3: Two required contextual lens of an economics which facilitates sustainability as human flourishing.

2.6 Holistic thinking

This is all about trying to encourage students to think more holistically. Firstly, there is a need to develop “sustainability informed engineers” as the very *context* through which they envision their profession and practice (Byrne and Mullally, 2014), rather than “business as usual engineers”. They should have a deep knowledge and consciousness of sustainability and the sustainability challenges facing humanity, and be somehow willing to engage with these throughout their careers. Furthermore, life cycle thinking (and assessment) is an important aspect of holistic thinking that engineers should be aware of.

2.7 Energy

Energy is common to all engineering disciplines, and is a major sustainability challenge. Consequently, all engineering students should receive a good education in issues around energy and sustainability, including dissipative energy (entropy) produced as per the second law, and its proportionate link with ecological degradation (Wessels, 2006). In the UCC chemical engineering programme, energy is dealt with from a global perspective and also from the perspective of a processing plant.

2.8 Transferable skills

There are a number of continuous assessments in the sustainability & environmental protection modules that assist in development of transferable skills, such as knowledge acquisition, critical thinking skills e.g. dealing with complexity / uncertainty, communication, team work, willingness to consider other sides of debates, and working with other disciplines (Fitzpatrick et al., 2020). These soft skills are particularly important for engineers working in a world where sustainable informed thinking provides the context for their work.

2.9 Transdisciplinarity

In addressing contemporary and emerging “grand challenges” associated with sustainability and the FEW nexus, disciplinary knowledge alone is insufficient. Engineers and scientists will need to work with and draw on knowledge and expertise from a range of other disciplines and from local experiential and community knowledge if we are to make authentic progress. Too often in our institutions however, we engage in the production of siloized disciplinary experts, before expecting our graduates to go out into the real world and work with others. The UCC programme brings together third year chemical engineers with sociology and government students taking an environmental sociology module to engage in a group assignment to consider some aspect of sustainability (Byrne & Mullally, 2016). This exercise adopts a transdisciplinary ethos, recognizing that through a transdisciplinary engagement we can collaboratively in a “greater than the sum of the parts” derive new insights and emergent knowledge and thus go places which any single discipline could not go. Moreover, second year students taking a communications module engage with finance students as part of an innovation energy transformation project and competition, with institutional, national and international rounds.

2.10 Values and ethics

The normative nature of sustainability means that choices and priorities are chosen based on values and value sets. This is highlighted throughout the programme so that graduate engineers recognize the

normative or value laden nature of decisions that they are involved in, rather than seeing socio-technical problems and proposed solutions in a rational “value free” decontextualized setting. While chemical engineers require attention to individual level micro-ethical concerns around personally doing the right thing (including whistle blowing, etc.), there is also the macro-ethical domain, where sustainability issues reside, such as the societal and professional body inherent values which govern approaches and practice (Conlan, 2010). While these are often overlooked in our programmes, we seek to address such macro-ethical issues in the context of global and sustainability perspectives (Byrne, 2012, 2014).

2.11 Worldviews and paradigms

The sustainability and environmental modules go beyond the technical by seeking to understand why it is we act as we do and indeed why we find it so hard to change. This leads to an exploration of the history of science and technology and an exploration of the dominant socio-economic neo-Cartesian paradigm which has characterized modernity as well as other paradigms and worldviews, including emerging integrative ones, which seek to integrate useful aspects of other preceding ones (Byrne, 2017).

2.12 Transformational change

Finally, in the context of seeking transformational change towards sustainable societies, students are invited to explore the role and value of agents of human change which reside outside the domain of engineering (and in the humanities) and which expressedly go beyond the merely quantitative, rational and reductive. These include the role of narrative, imagination, myth and metaphor in precipitating authentic societal and cultural change. They are thus encouraged to reflect on how these may impact or enhance engineering practice.

3 Conclusions

Engineers cannot just be technological “guns for hire” who reside in “tech silos”. Engineering graduates hoping to contribute to a world transitioning to a sustainable society need to be equipped with a variety of non-discipline specific sustainability knowledge & competences. Engineering education has an important “foundation” role to play in the formation of sustainability informed engineers, who acquire an in-depth awareness of humanity’s grand sustainability challenges and the importance of the socio-economic dimension of sustainability that compliments their technical capabilities. Some of these engineers, equipped with this awareness, may be able to couple this with their own innate talents that favours a move towards a sustainable direction within their own work organisations, and/or within broader society. Furthermore, it will enable them to work more effectively with those in other disciplines.

The inclusion of non-discipline specific sustainability knowledge & competences represents a real and explicit attempt to provide a useful intervention at a key point in the educational formation of undergraduate engineers, one which, in time may produce a valuable positive impact. It is hoped that by providing engineers with some basic tools, in particular the ability to think critically around sustainability issues and narratives that they may, over the course of their future careers and lives, engage in a positive manner with the issues at hand, resulting in greater societal good as well as enhanced personal and professional satisfaction.

References

- Alpay, E., Ahearn, A.L., Graham, R.H., & Bull, A.M.J. 2008. Student enthusiasm for engineering: charting changes in student aspirations and motivation. *European Journal of Engineering Education*, 33, 5, 573-585.
- Anderson, R.C. 2009. *Confessions of a Radical Industrialist – How Interface Proved that you can Build a Successful Business without Destroying the Planet*. Random House Business Books, London, UK.
- Byrne, E.P., & Fitzpatrick, J.J. 2009. Chemical engineering in an unsustainable world; obligations and opportunities, *Education for Chemical Engineers*, 4, 51-67.
- Byrne, E.P. 2012. Teaching engineering ethics with sustainability as context. *International Journal of Sustainability in Higher Education*, 13, 3, 232-248.
- Byrne, E.P. 2014. Mapping the Global Dimension within teaching and learning In: *Global Dimension in Engineering Education* (eds) Integrating GDE into the Academia. Engineers Without Borders, Barcelona.
- Byrne, E. 2017. Sustainability as contingent balance between opposing though interdependent tendencies; A process approach to progress and evolution. In: E. Byrne, G. Mullally and C. Sage (eds). *Transdisciplinary Perspectives on Transitions to Sustainability*. Routledge.
- Byrne, E.P., & Mullally, G. 2014. Educating engineers to embrace complexity and context, *Proceedings of the Institution of Civil Engineers -Engineering Sustainability*, 167, 6, 241-248.
- Byrne, E.P., & Mullally, G. 2016. Seeing Beyond Silos: Transdisciplinary Approaches to Education as a Means of Addressing Sustainability Issues. In: W. Leal Filho and S. Nesbit (eds). *New Developments in Engineering Education for Sustainable Development*. Springer.
- Brown, L.R., 2012. *Full Planet, Empty Plates – The new geopolitics of food security*. Norton Publishers, NY.
- Conlon, E. 2010. Towards an integrated approach to engineering ethics. *3rd International Symposium for Engineering Education*, Cork 1-2 July 2010.
- Dietz, R., & O'Neill, D., 2013. *Enough is Enough – Building a Sustainable Economy in a World of Finite Resources*. Earthscan, Oxford, UK.
- Ehrenfeld, J.R., & Hoffman, A.J., 2013. *Flourishing: A Frank Conversation about Sustainability*. Stanford University Press.
- Fitzpatrick, J.J., 2017. Does engineering education need to engage more with the economic and social aspects of sustainability? *European Journal of Engineering Education*, 42, 6, 916-926.
- Fitzpatrick, J.J., & Byrne, E.P., Gutiérrez Ortiz, F.J., 2020. The Contemporary Engineer: Developing Sustainability Competences and Transferrable Skills through Open-ended Activities. *10th International Conference Engineering Education and Sustainable Development*, 7th-10th June, Cork Ireland.
- Meadows, D., Randers, J., & Meadows, D. 2005. *Limits to Growth: The 30-Year Update*. Earthscan, Oxford, UK.
- Wessels, T. 2006. *The myth of progress: Toward a sustainable future*. University of Vermont Press.

The Contemporary Engineer: Developing Sustainability Attributes and Transferable Skills through Open-ended Activities

John J. Fitzpatrick¹, Edmond P. Byrne¹ and Francisco Javier Gutiérrez Ortiz²

¹Process and Chemical Engineering, School of Engineering, University College Cork, Ireland

j.fitzpatrick@ucc.ie

²Department of Chemical and Environmental Engineering, School of Engineering, University of Seville, Spain

Abstract

An essential aspect of engineering education is the provision of core competences in discipline specific knowledge and its application. Added to this, engineering education must equip its students with a range of transferable skills in order to facilitate their working within a variety of organisations, skills which are much valued by employers. Critically for the 21st century, engineering graduates entering the workforce must be equipped with knowledge and competences in sustainability / sustainable development, as this is becoming more and more important within organisations. More importantly it is an existential imperative for humanity, which is of particular relevance to young people, including newly graduated engineers who must be equipped with sustainability knowledge and competences to effectively contribute to the good of a society that needs to transition to a sustainable pathway. Such competencies are also required by professional accreditation organisations. This may require paradigmatic change in how we view both our profession and the world we inhabit.

This paper briefly highlights a number of proposed sustainability related skills and competences. It then focuses on the development of these through open-ended activities and problems. This is based on the active learning premise where students achieve better quality learning by actively doing things themselves. The paper outlines four examples of activities undertaken at University College Cork and at the University of Seville. They include a transdisciplinary group exercise, environmental consultancy role-play, sustainability / environmental debates, and converting a closed well-defined problem into an open-ended one followed by the addition of layers of complexity and holistic considerations. It highlights the learning outcomes, transferable skills and sustainability knowledge and competences that students may obtain from undertaking the highlighted activities.

Keywords: sustainability competences; transferable skills; open-ended activities; graduate attributes

1 Introduction

Conceptions of progress should be guided from a broader sustainability perspective rather than from a traditional perspective based on technologically enhanced efficiency and economic growth, worldviews which have served to exacerbate the contemporary crisis of unsustainability around so many issues including climate, biodiversity and energy (Byrne, 2017). The latest UN Environment Programme Emissions Gap Report (UNEP, 2019) warns that there is even still ‘no sign of GHG emissions peaking in the next few years’. As a result of our continued inaction, ‘deep and rapid decarbonization processes imply

fundamental structural changes are needed’, accompanied (paradigmatically) by ‘deep-rooted shifts in values, norms, consumer culture and world views [which] are inescapably part of the great sustainability transformation.’

Byrne and Fitzpatrick (2009) previously argued for sustainability as a contextual lens for the formative education of chemical engineers. This requires active engagement with other disciplines and with wider society, and an elevated sense of ‘contextual awareness’ (Staniskis and Katilute, 2015), all in the wider context of increasingly elevated levels of societal and technological complexity, uncertainty and interconnection (Byrne and Mullally, 2014). Consequently, the contemporary engineer requires competences not just in the ‘knowledge’ domain (‘the data base of the professional engineer’), but also that of ‘skills’ (analysis, communication, leadership, teamwork), and ‘attitudes’ of the profession, the values based the ethical framework of professional practice (Rugarcia et al., 2000; Jansen et al., 2008). Within this framework, graduate engineers require sustainability knowledge, skills and values. The successful incorporation of all these components into the curriculum necessarily requires more student-centred teaching/learning approaches, for example, through the use of open-ended activities. This can help students in the making of decisions taking into account the social, ethical, and sustainability related consequences of those decisions. This conception increases the expansive role that engineers can play, not just in addressing complex problems with societal and natural dimensions, but also in *framing* such problems (applying context and values). The aims of this paper are:

- 1) To highlight the need for engineering graduate attributes with enhanced sustainability oriented transferable skills, competences, and values, so as to enhance their employability and value within a society that is necessarily transitioning towards a sustainability informed paradigm.
- 2) To highlight and promote the key role that the application of open-ended activities and problems can play in engineering education to help better develop all the above, including to enhance the development of core engineering technical competencies.

2 Graduate attributes for employment in a society transitioning to a paradigm of sustainability

Contemporary engineering graduates must acquire the requisite disciplinary knowledge, transferable skills, professional values (through a sustainability informed context and lens) for a successful career and valuable contribution to both the organisations in which they work and society as a whole. This facilitates a sort of virtuous circle, as illustrated in Figure 1, resulting in a professional cohort and profession which is both more relevant to its society and its employers, while also demonstrating enhanced attractiveness to potential recruits.

The graduate attributes of a contemporary engineer are schematically presented in Figure 2. At its core is a engineering graduate who must possess a core competence in their discipline-specific engineering knowledge and its application. This has always been a key remit of engineering and will always remain so. In the contemporary workplace however, employers desire graduates that are also well equipped with a variety of transferable skills (for example, as outlined in Table 1). They also require engineers who engage with, reflect on and display professional values around safety, societal wellbeing, product and process quality, and sustainability.

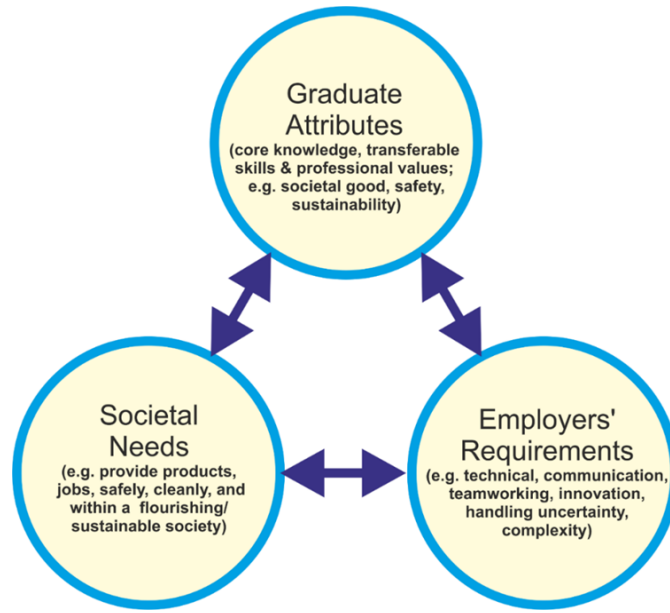

Figure 1: Coherence between graduate attributes and employers and societal needs

Now and in the future, employers require graduate engineers who demonstrate sustainability attributes (for example, as outlined in Table 2) across each of the domains of core knowledge/competences, transferable skills and values. This bundle of overarching graduate attributes all can (and do) thus feed into both employer’s requirements as well as wider societal needs (Figure 1).

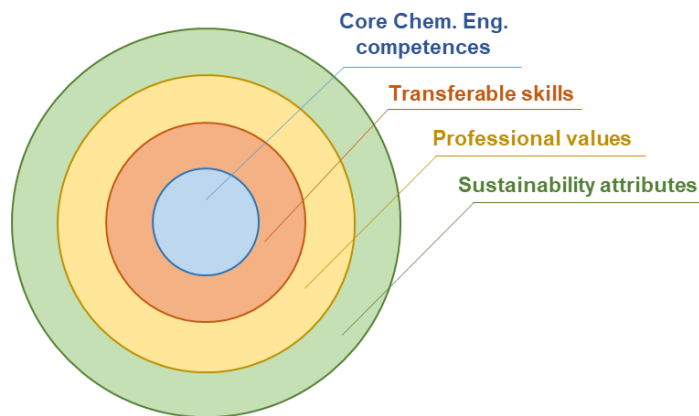

Figure 2: Graduate attributes of a contemporary engineer

Employers require graduates with requisite technical expertise and depth of knowledge, but also capable of engaging in teamwork, employing excellent communication skills (with both technical and non-technical audiences) and are capable of handling increased levels of uncertainty and complexity. Society requires engineers who solve engineering problems, but in a way which does so safely, cleanly and without environmental degradation to the benefit of society most broadly (and equitably); essentially, proactively contributing towards a flourishing society.

Engineering is intrinsically about trying to do good for society by facilitating the provision of goods and services that can make people’s lives better; this is why many of us decide to become engineers! As we

progress through the current century, just the third since the onset of the industrial revolution, there is a real worry about the unsustainability of our current dominant global techno-economic system and its impact on humanity itself and the ecological life support systems which envelop us. Consequently, the advancement of human flourishing itself has become a major contemporary concern, if not the dominant concern.

Table 1: Desirable transferable skills of a contemporary engineer

Communication	Life-long learning
Dealing with complexity / uncertainty	Problem solving / innovation
Entrepreneurial	Research skills
Information technology	Team working
Knowledge acquisition	Time management

This impacts on engineering (and engineering education) because engineering is about contributing to societal good, and to do so over time. Thus, sustainability related knowledge and values, as well as the ability of engineering to contribute to human flourishing is rapidly becoming a contextual lens or overarching paradigm through which engineering education can be posited, as illustrated conceptually in Figure 2. Furthermore, for business, employers and young people, sustainability is becoming more critically important.

Table 2: Some sustainability attributes of a contemporary engineer

-
- Knowledge and understanding of the sustainability issues and challenges.
 - Ability to develop appropriate greener technologies, processes and approaches
 - Ability to apply relevant transferable skills (Table 1) towards sustainability goals/contexts
 - Sustainability values (*e.g. concern for the environment, commitment to sustainable development and social justice, empathy*).
 - Deep appreciation of the importance of the social, ethical, ecological and economic dimensions of sustainability, and the interconnectedness of each.
-

A fit-for-purpose contemporary engineering graduate must acquire the requisite disciplinary knowledge, transferable skills, professional values and sustainability attitudes for a successful career and valuable contribution to both their enterprises and society. This requires an explicit reaching out and structural embedding of transferable skills, professional values and overarching sustainability attributes within and across our programmes as well as through the traditionally well-covered domain of instrumental knowledge, all in an integrative fashion. More explicitly, a pedagogical approach based on creative open-ended activities and problem solving is proposed as a means of enhancing technical competences as well as developing requisite transferable skills, professional values and sustainability attributes. For the most part, this can be delivered through relevant and bespoke continuous assessment exercises, as employed both extensively and progressively throughout the programme. In this light, the following section focuses on application of open-ended activities for the enhancement of technical competence, and development of transferable skills, professional values and sustainability attributes under a broader sustainability context and ethos.

3 Application of open-ended activities to help develop transferable skills and sustainability attributes

This section provides four examples of open-ended activities and problems from the Chemical Engineering Departments at University College Cork and University of Seville. These are presented to show how the aforementioned attributes, skills and competences can be developed and enhanced through open-ended activities and problem solving. These activities have many different facets that students have to think about, such as technical, environmental, ethical, economic and social, and are mainly carried out as group exercises.

3.1 Transdisciplinary sustainability assignment

This assignment brings together third year students of the chemical engineering module on sustainability and environmental protection with students on an analogous but separate third year module on ‘Sociology of the environment’, taken by sociology and government students. This novel arrangement also facilitates the bringing together of visiting students (taking each of the modules) on a transnational basis - including from Brazil, Denmark, Germany and USA. The task is for mixed groups (of chemical engineers, sociologists and government students) to frame, consider, research and present on some chosen aspect of sustainability, for example “the socio-environmental impacts of plastics”; “concepts of progress”; “sustainability in terms of consumerism and consumption” (see Byrne and Mullally (2016) for a detailed description). The exercise has resulted in some inspiring and innovative insights while transcending disciplinary silos in an ethos of open transdisciplinary. The following respective student comments on the exercise help elaborate their insights:

‘working in a team with vastly different opinions is hugely valuable to our careers in the future’ / ‘a major learning point was taking on board alternative perspectives of problems, outside of engineering solutions.’ / a ‘transdisciplinary approach was enlightening; [an] engineering solution isn’t always the only option’ / and from a sociology student: I learned ‘that it’s harder than I had thought to find perspectival common ground between different disciplines – so this needs to be encouraged more across the university!’

In this assignment the transferable skills and sustainability attributes developed by the students include inter/transdisciplinary work, communication, empathy and change of perspective, and critical thinking.

3.2 Environmental consultancy assignment

This is a group “role-play” assignment where each student group has to imagine themselves as employees of an environmental consultancy firm who are sent to provide consultancy to an organisation whose senior management representative is ‘role-played’ by the lecturer. The organisation could be a chemical processor or some other organisation such as a bank or a hotel, and some basic information is provided about the organisation. The senior management representative is somewhat environmentally conscious and has heard that an environmental management system (EMS) approach could help the organisation improve its environmental performance. He has heard of the environmental consultancy firm and has made some initial contacts. As a consequence, the student group has been sent as a team of environmental consultants by their firm to make a fifteen-minute presentation to the senior management representative of the organisation, followed by questions, answers and discussion.

The objectives of the group presentation are:

1. To explain to the senior management representative what an EMS is, and to enlighten him as to why he should seriously consider implementing an EMS in his organisation.
2. To outline the environmental performance issues for the organisation and to provide a rough outline of a plan of activities that could potentially improve environmental performance, while also including a business case for the plan.

The grading is based on both individual and group performance, and the quality of the slides presented. The assignment helps students develop a greater understanding of aspects of environmental sustainability in the context of an organisation. This is achieved by demonstrating an understanding of the implementation of an EMS in an organisation, and by creatively innovating ideas for activities that may help an organisation improve its environmental performance, while recognising both business opportunities and costs. The assignment helps each student enhance their team working skills and communication / presentation skills. Finally, the students gain an initial experience of working and thinking as an environmental consultant, officer or manager, which could influence them in their future careers.

3.3 Environmental/Sustainability debates

Student environmental/sustainability debates are held on topics of environmental/ sustainability interest that are somewhat controversial, such as “Nuclear fusion is an energy “holy grail” with widespread use by 2050”; “Human impact on biodiversity should be of major concern to humanity”; “Carbon capture, storage and utilisation will be a very important approach in the fight against climate change”.

The students are divided up into teams where one team prepares and debates the pros side of the topic and the other the cons. The students are encouraged to investigate the topic from a broad perspective, which includes any economic, ethical and social issues in addition to environmental and technical. The first phase of the assignment requires students to research the topic and then each student must post a comment to an on-line discussion forum. Then, the students consider the comments posted on their debate and then each student posts a second comment, which may be a rebuttal to comments made by the other team. This process helps build up information on both sides of the debate. This acts as the basis for the debate itself, whereby each group must summarise their side of the debate and give a five-minute oral presentation during a regular class session. For each debate, there is five minutes for the pros, followed by five minutes for the cons, followed by five minutes of questions and discussion. Each group must then submit a final group written report, which has the following three parts: 1) summary of their side of the debate, 2) summary of the opposition’s side, and 3) their final balanced opinion on the topic of the debate, considering both the pros and cons.

The assignment helps the students develop their ability to comprehend, present, argue and discuss issues of relevance to environmental protection and sustainability. The students are strongly encouraged to understand and appreciate the arguments made by the opposition and that trying to form a balanced opinion is very important in this assignment. This highlights that many environmental and sustainability issues are complex and multifaceted and that they need to be open to and appreciate the complexity and multifaceted nature of these issues.

3.4 Converting a closed-ended problem into an open-ended problem with additional layering of complexity and holistic considerations

The starting point may be a classical academic problem of overall mass balance with general chemistry. The solution is unique, and the students have all the data they need to solve the problem.

There are a number of possible ways to turn the above problem into an open-ended one. The easier way would consist of omitting some data or presenting the problem with an excess of data, as oftentimes occurs in the real world, so that students must learn to identify and use the necessary data, disregarding the rest. This is directly and easily implemented in the same subject and its extension in the second year, simply by changing some initial data to avoid the use of previous ones given in the first year. Normally, students are confused when dealing with more data than needed, and become worried when there is a lack of data. Initially, they are a bit exasperated, but ultimately they engage more strongly with the subject matter and discipline. Once we have the initial open-ended problem, which is focused on mass balance, a fluid-mechanics open-ended problem could be included, so students must compute the pressure drop of gas by deciding on the superficial velocity of gas in pipes. To solve the fluid-mechanics problem, the students need a set of data, need to look for some other data and make some assumptions, which must be justified and revised after finalising the problem, just as in the real world. Later, fans and boosters are added, which need to be selected and specified using different criteria that students will have to weigh with each other. At this point, process control and instrumentation may be incorporated to the problem, since there are a number of variables to be controlled (pressure, flow-rates or temperature in some equipment) which involve measuring these variables and others. These may include large disturbances which require the application of advanced regulatory control techniques such as feed-forward action or a cascade strategy, as often used in industry. Students select sensors and transmitters based on some constraints given in the problem, but then make decisions from a myriad of possibilities by identifying and following various criteria.

In addition, other disciplinary core competences could be added to these open-ended activities (overseen by lecturers in these areas), such as those relating to mechanical engineering (e.g. material selection e.g. corrosion effects, use of Standards, basic foundations of a particular unit or structure, pipe supports, thermal expansion studies) or in relation to electrical engineering (e.g. specification of electrical motors for the fans previously designed, or basic elements on the electrical circuits).

Once the technical knowledge core of chemical engineering is covered, along with many transferable skills, new criteria to make a decision on the best solution can be added based on an economic assessment and on an environmental assessment related to sustainability, using Life Cycle Assessment (LCA) of the installation. At this point, investment and operating costs regarding the environmental protection must be considered in order to obey the law that limits the impacts on environment, so transiting towards sustainability is possible. In fact, although a current business may have lower production cost than another one which is newer and more sustainable (so one could think that sustainability is good but expensive), the traditional and current business could have a short life if some commonly used resources are scarce or involve a way to obtain them that leads to a severe and irreversible deterioration of nature resulting in the depletion of those resources and, hence, in closing the business. In this situation, and taking a long term to develop the business, the sustainable option could be the best option and, in fact, a more profitable option if the business could be extended over time. This is a clear example of competing facets and trade-offs in the open-ended activity assignments. In fact, a trade-off is a common situation in real life, and open-ended

(real) problems and activities give the students the opportunity of thinking about advantages and disadvantages of using one or another solution and the responsibility of making decisions.

4 Conclusions

This paper highlights how a fit-for-purpose contemporary programme can develop key knowledge, competences and values in a sustainability informed context, and, in doing so, can help meet employability requirements and societal imperatives. Open-ended activities and problems, in their many guises, represent a useful vehicle in this aspect as they require creativity, communication and leadership, as students working on them can express their insights and arguments to their classmates and lecturers, thus integrating knowledge and developing transferable skills, while facilitating sustainability values. The work may be both individual and collaborative across respective stages, to promote personal involvement and critical thinking skills, as well as interpersonal relations and collaboration. Through a framework of open-ended activities and problems, students can thereby readily communicate, critically analyse, work in teams, work within and across disciplinary bounds, and handle uncertainty, in an increasingly post-normal environment. Problem specifications can also be opened increasingly and progressively, to help students develop the skills to handle problems with multiple framings and multiple potential solutions or interventions. This can materially help develop the attributes that current and future engineers need to integrate disciplinary knowledge, transferable skills and appropriate values into professional practice, while embracing the incorporation of inherent uncertainty, amid social, ethical, sustainability and environmental contexts and paradigmatic change.

References

- Byrne, E.P., Mullally, G., 2014. Educating engineers to embrace complexity and context. Educating engineers to embrace complexity and context. *Proc. ICE Eng. Sust.* 167, 241-248.
- Byrne, E.P., Mullally, G., 2016. New Developments in Engineering Education for Sustainable Development. In: Leal Filho and S. Nesbit (eds.), *World Sustainability Series*, Springer International Publishing, Switzerland.
- Byrne, E.P., 2017. Sustainability as contingent balance between opposing though interdependent tendencies: a process approach to progress and evolution. In: E. Byrne, G. Mullally and C. Sage (eds), *Transdisciplinary perspectives on transitions to sustainability*. Oxon: Routledge.
- Jansen, L., Weaver, P., Van Dam-Miersa, R., 2008. Education to meet new challenges in a networked society. In: J.E. Larkley, V.B. Maynard. (eds). *Innovation in Education*. New York: Nova Science Publishers.
- Rugarcia, A., Felder, R.M., Woods, D.R., Stice, J.E., 2000. The future of engineering education: a vision for a new century. *Chem. Engr. Educ.* 34 (1), 16-25.
- Staniskis, J.K., Katiliute, E., 2015. Complex evaluation of sustainability in engineering education: case & analysis. *J. Cleaner Prod.* 120, 13-20.
- UNEP, 2019. Emissions Gap Report 2019. *United Nations Environment Program*. Nairobi, Kenya <https://www.unenvironment.org/interactive/emissions-gap-report/>

A Sustainable Technologies Certificate Designed for Engineering and Engineering Technology Students (EESD2020)

Patricia Fox¹ and Charles McIntyre¹

¹ Indiana University-Purdue University, School of Engineering and Technology, Indianapolis, IN, USA

psfox@iupui.edu

Abstract

This paper will examine a Sustainable Technologies Certificate for undergraduates that began in 2013 to teach engineering, engineering technology, and other majors about sustainability and sustainable development. The certificate was created by multiple faculty in several departments in the Indiana University Purdue University Indianapolis (IUPUI), School of Engineering and Technology. While sustainability is incorporated and more well known in other parts of the world, the subject is increasingly important to the State of Indiana and U.S. businesses, industries, municipalities, and citizens. The Sustainable Technology Certificate introduces students to sustainability and many different sustainable technologies.

1 About IUPUI

Indiana University Purdue University Indianapolis (IUPUI) is Indiana's premier urban research university located in Indianapolis, Indiana, U.S. IUPUI offers more than 450 undergraduate, graduate, and professional programs including certificates. IUPUI has two colleges and 17 distinct schools. Student who attend IUPUI are conferred degrees or certificates from either one of the top universities in the state, Indiana University or Purdue University. Graduates of IUPUI can receive degrees or certificates from both universities. The two universities have a unique partnership in Indianapolis. The main campus for Purdue University is located in West Lafayette, Indiana about 60 miles north of Indianapolis. The main campus for Indiana University is located in Bloomington, Indiana about 60 miles south of Indianapolis. The two universities are combined in Indianapolis, the capital of the state of Indiana. Indiana University has the majority of schools than its partner Purdue University at IUPUI. There are two Purdue schools on the IUPUI campus, the School of Science and School of Engineering and Technology. IUPUI has approximately 30,000 undergraduate and graduate students and offers Certificates, Bachelors, Master's and PhDs. IUPUI has a significant number of online classes, programs, and degrees (IUPUI, 2020). The state of Indiana is located in the Midwest of the United States. The authors of this paper both teach at the Purdue School of Engineering and Technology at IUPUI.

2 The U. S. Midwest and Indiana

IUPUI's location in the U.S. is important to understand what the need is for the Sustainable Technologies Certificate. Sustainability has had very slow progress in the State of Indiana and the Midwest. A typical state in the Midwest, like Indiana, is mostly made up of a few large cities (some major) and a lot of small towns and farming communities. Sustainability in the U.S. took off more rapidly on the East and West coasts in the late 60s and early 70s. Cities on the West coast are constantly ranked high in sustainability cities lists. Now major cities in the Midwest are looking to be more sustainable. Sustainable cities "can be thought of as places that are planned and managed with consideration for social, economic, environmental impact, providing a resilient habitat for existing populations, without compromising the ability of future generations to experience the same" (Citizen Centric Cities, 2018). The Sustainable Cities Index is based on people (social), planet (environment) and profit (economic). In 2018, London was ranked number 1 on

the Sustainable Cities Index, New York the first U.S. city listed on the rankings was number 14. Indianapolis was ranked number 64 (Citizen Centric Cities, 2018).

However, in Indiana many small and large cities now have a sustainable commission or a sustainable office, which evaluates the city on sustainable initiatives. Another example of promoting sustainability is the Earth Charter Indiana group, which has information about sustainable activities in the state for climate change in Indiana. The Earth Charter Indiana was established in 2001 based after the Earth Charter that was established in Hague, Netherlands in 2000. The Earth Charter is a proclamation of fundamental principles for building a just, sustainable and peaceful global society in the twenty-first century. The Earth Charter Indiana is trying to do the same for the State of Indiana. There are a number of other groups and activities in the state that are also promoting sustainability activities. However, this is a Republican state and many rural and farm towns, do not adhere to sustainable practices, for example, the state legislators just proposed a new bill to the use of coal in Indiana, even though it is less expensive to use natural gas and look at sustainable energy. This is typical of the “red” (Republican) state in the Midwest.

Wind and solar development started late in Indiana. Large scale wind power started in 2008. Wind energy growth in the state has continued since 2008 with about 15 projects. In 2017, Fowler Ridge Wind Farm in three counties in northern Indiana was ranked one of the largest wind farms in the world (Wikipedia Indiana State wind power, 2019). In 2017, Indiana ranks 12th in the U.S. in installed wind capacity and number of wind turbines, yielding almost 5% of the state’s energy needs. (Wikipedia-Wind Power in Indiana, 2019). The year 2009 was the first year for Indiana to see photovoltaics at any scale in the state. Indiana ranked 23 out of all the states for solar power. In 2019, only .042% of the state’s electricity is powered from solar (Wikipedia - Solar Indiana, 2019).

3 History of Sustainability in the U.S.

Sustainability started in the U.S. around 1969 with the National Environmental Policy Act (NEPA). (Note: President Donald Trump recently announced the overhaul of the NEPA – unfortunately to the detriment of the environment.) This law was enacted in response to a number of events including a devastating oil spill near Santa Barbara, California, which had a damaging impact on wildlife and the natural environment (Stofleth, 2015). In addition, the U.S. public became more aware of the consequences to land and water due to industrial pollution, especially with the publication of a book by Rachel Carson, *The Silent Spring* Rachel’s book highlighted the destruction of birds and wildlife due to the use of DDT (Carson, 1990). This was also a time in the U.S. when there was a push for great concerns about the health of the environment. Soon after, followed the U.S. Clean Air Act, Water Quality Act, and a push to ban DDT. In addition, in 1972, the United Nations had a conference on Human Environment, which outlined the rights of humans to have adequate food, sound housing, safe water, and access to family planning.

Unfortunately, the U.S., as a whole, has not embraced sustainability and has not moved forward with sustainability activities in a timely manner such as in other countries. However, some cities in the U.S. are actively pursuing sustainable agendas. Portland, Oregon leads the list for the most sustainable city in the U.S. with half of its energy coming from renewable sources (Light, 2013). Other U.S. cities are leading the way with large scale recycling and composting programs. San Francisco, eliminates 80% of the city’s waste through its recycling and composting program. In addition, the San Francisco has approximately 700 LEED-certified building projects (Light, 2013). In order to have a greater and long-lasting impact, sustainability issues need to be addressed at the national, state, and local levels, such as in Germany and other European countries. At the corporate level, companies such as Interface, Inc. have made tremendous contributions to the movement of sustainability in the U.S. (Anderson, 2011). In the early 1990s Interface

embarked on a sustainable journey after its leader, Ray Anderson, was asked by its suppliers what was the company doing for the environment? On its way, it changed from a heavy petroleum-based product to recyclable carpet tile all the while on the goals of zero land fill and zero environmental footprint (Anderson, 2011). Other companies need to step up to pursue sustainable agendas like Interface., however, many tout some corporate social responsibility activities without really pursuing a sustainable journey.

In the early 2000's sustainability has regained some importance in the U.S. in business, industry, government, non-profits, higher education, and in the general public's consciousness. The goal of meeting today's needs without harming future generations' ability to realize their potential is a hallmark of sustainable practices. There is widespread interest from many disciplines and sectors in developing, enhancing, and integrating sustainability into aspects of organizations. Thus, the need to equip students with the knowledge and skills to make contributions to sustainable initiatives has never been greater. Green jobs are being created in the U.S. as the economy embraces sustainable, energy efficiency, and low-carbon practices. The driving forces behind the development of green jobs are businesses that desire to maintain cutting edge technology, eliminating waste, becoming more energy efficient, lowering carbon footprint, and/or becoming entirely carbon neutral.

4 Rationale for Certificate

IUPUI adopted the Sustainability Technologies Certificate because, in recent years, sustainability and sustainable development have gained prominence the U.S., in the State of Indiana, and in the general public's consciousness in the United States. Sustainability is being incorporated into industry, business, education, municipalities, as well as the daily lives of people. There is a growing demand for individuals with knowledge in sustainability in organizations across the for-profit, nonprofit, and government sectors. Individuals sought by these groups include consultants, coordinators, managers, and/or advisors for organizations seeking to introduce a sustainability component to their managerial, administrative, or programmatic operations.

IUPUI, through its Office of Sustainability and the Academic Sustainability Committee, recognized the importance of sustainability to the future of Indianapolis and the surrounding communities, the state as a whole, and its current and future students and residents. Sustainability is not a particular set of knowledge, skills, or abilities, but is an approach—a way of thinking—that spans disciplinary boundaries. Students draw strength in their careers and their personal lives by learning to think sustainably from the multiple disciplinary perspectives as required in this certificate.

There is a growing need for recognized degrees in sustainability, including certificates. Sustainability is already incorporated in Indiana and Indianapolis, which are moving slowly toward a green economy. According to the U.S. Department of Labor, Bureau of Labor Statistics, there were more than 3.4 million “green goods and services” jobs in the United States in 2011, including 70,156 in Indiana. Indianapolis is home to many innovative projects that are producing green jobs from storm water management, energy efficiency projects, tourism, to recycling (Ellis-Lamkins, 2012). Indianapolis has established an Office of Sustainability, charged with overseeing the greening of the city/county government's operations.

5 The Sustainable Technology Certificate

This certificate was proposed by three faculty members in three different departments in the School of Engineering and Technology. The certificate was approved in 2011. The faculty received an IUPUI curriculum development grant to design all six courses. Several of the courses were first presented in the fall semester of 2013 in a rotating method offering two course per semester. Now, three courses are

offered each fall, spring, and summer semesters giving students the ability of earning the certificate in one year. Students are required to successfully complete a total of 6 courses (18 credit hours with a grade of C or better) to earn the certificate. The pre-requisite for the certificate is a basic undergraduate level English course. No more than 9.0 units of transfer credit can be applied towards the certificate. The courses, titles, and credit hours for the certificate are listed below:

Course Number, Course Title, and Credit Hours

OLS 20000	Introduction to Sustainable Principles and Practices	3credits
TECH 30100	Renewable Energy Technologies	3 credits
TECH 30200	Introduction to Green Building Technologies	3 credits
TECH 30300	Energy Efficiency and Auditing	3 credits
OLS 30200	Economics and Leadership Aspects of Sustainable Technologies	3 credits
TECH 40200	Emerging Green Technologies	<u>3 credits</u>
Total Hours		18 credits

All of the certificate courses are offered on-line and were new to this program. Per the terms of the IUPUI Curriculum Enhancement Grant, awarded through IUPUI’s Center for Teaching and Learning, the following courses were all developed over two summer sessions. The course descriptions are listed below:

(1) OLS 20000 - Introduction to Sustainable Principles and Practices – This course introduces students to sustainability and its principles; it focuses on how and why sustainability is important. The course covers: principles, history, definitions, and historical economic aspects of sustainability. It also covers principles of sustainability to design, building, energy, and commerce. The book, *Sustainability- Principles and Practices second edition* by Margaret Robertson, is used in the course. In addition, videos and articles are supplemented for each chapter.

(2) TECH 30100 - Renewable Energy Technologies - This course provides the student with an introduction to renewable energy. Topics include photovoltaic, solar thermal systems, fuel-cells, hydrogen, wind power, waste heat, bio-fuels, wave/tidal power, geothermal power and hydroelectric. Discussions of economics, environment, politics and social policy are integral components of the course. The text, *Renewable Energy: Power for a Sustainable Future-* third edition, by Godfrey Boyle, is used for this course. In addition, videos and articles are used to supplement the text.

(3) TECH 30200 - Introduction to Green Building Technologies - This course examines, discusses and analyzes buildings. Building systems and assemblies (both residential and commercial) will be discussed and will include topics such as the principles of: thermal efficiency and comfort, climate, shading, site design, day lighting, efficient building envelopes and mechanical equipment. Chapter 1 - *Overview of Green Building* by J. Culllen Howe is used for this course as well as supplemental articles and videos.

(4) TECH 30300 - Energy Efficiency and Auditing - This course introduces energy audits and methods to improve energy usage in commercial/industrial systems. Topics include energy audit process, energy bill analysis, economic analysis, survey instrumentation, building envelop, electrical system, HVAC system, waste heat recovery, lighting, cogeneration, and other prevalent industrial systems. Current videos and articles are used to teach this course.

(5) OLS 30200 - Economics and Leadership Aspects of Sustainable Technologies - The main focus of this course is to learn how organizations make sustainability function in their organizations. Students learn about the triple bottom line (environment, social and economic aspects of business decisions) and how to make “sustainability” thrive in an organization. The book, *Making Sustainability Work: Best Practices in Managing and Measuring Corporate Social, Environmental and Economic Impact* – second edition by Epstein. and Buhovac (Greenleaf Publishing), is used for this course. The online modules are supplemented with videos and articles.

(6) TECH 40200 - Emerging Green Technologies - This course will examine, discuss, and investigate new emergent green technologies in renewable energy, green building, sustainable design, and other green technology emerging in the marketplace. Current videos and articles are used for this course.

The certificate in Sustainable Technologies provides a unique and innovative academic alternative at IUPUI for the following reasons:

- 1) The certificate is multidisciplinary. It cuts across the disciplines of science, engineering, technology and leadership in order to provide a comprehensive approach to education in sustainability.
- 2) The certificate is interdisciplinary and transdisciplinary. It mixes course content from traditional disciplines into individual courses, allowing students to see the relationships between concepts and theories in one discipline in the context of others.
- 3) The certificate is an undergraduate program. This will build the foundation for future degree programs and will provide an entry point for those interested in sustainability, yet who may lack the advanced education to apply to a more advanced level degree.
- 4) The certificate will encompass practical application courses so that students are not solely exposed to theory but will be engaged in hands on experience with sustainable technologies.
- 5) The certificate will be globally focused. The curriculum will provide an opportunity for international experiences (students may substitute a sustainability study abroad course – GO GREEN for one of the courses in the certificate) as well as discussion of international topics that will encourage a focus upon the world outside of Indiana and the United States.
- 6) The certificate will involve an opportunity for community and service related projects into the curriculum so that students have an opportunity to see the impact of green technologies within real life situations.
- 7) The certificate will provide the opportunity to learn about emergent technologies that will place the graduates at the forefront of cutting-edge ideas and concepts in an era struggling to come to terms with the impact of technology.
- 8) The certificate will develop graduates with specific skills that are needed to advance in a competitive green job market.

- 9) The certificate will build upon the success of pilot courses and initiatives in green technology already at IUPUI (e.g., GO GREEN study abroad program)

This certificate was designed for students who wish to study and work in what is currently called the “green jobs” sector. It was designed to serve students enrolled in Architectural Technology, Interior Design, Construction Management, Electrical Engineering Technology, Mechanical Engineering Technology, and Organizational Leadership, as well as, General Studies, Liberal Arts, Science, Public and Environmental Affairs, and Informatics, however, the program is open to all majors. The certificate is designed to be completed on a stand-alone basis or in combination with a degree.

One of the faculty members who designed the certificate has taught other sustainability courses at IUPUI since 2003. One such course is a study abroad titled, Green Organizations: Global Responsibility for Environment and Economic Necessity (GO GREEN). The study abroad is eight days in Germany visiting businesses, industries, and municipalities to look at sustainable practices. This study abroad course has been offered for 18 years. Students do pre-and post-work at IUPUI in addition to traveling to Mannheim, Germany. Certificate students can substitute this course for one of the certificate courses.

6 Certificate Progress since Fall 2013

The student enrollment numbers in the certificate courses started out with very low numbers beginning in fall of 2013. The enrollment numbers were as low as 3 to 8 students in the courses offered. Since about spring 2015 a large number of these course are at full capacity with a wait list and others are almost full. Some courses went from enrollment of 3 to 23 the next semester offered. Authors believe that this was due to efforts of marketing and advertising the certificate to interested students. For low enrollments courses in the early years where the administration would normally cancel the class. Several of the faculty, who had developed the certificate, taught those under-enrolled courses for no credit towards their teaching load. The certificate is now in its sixth year of being offered. Since the fall of 2019, three of the courses have been offered every semester. There are 22 students currently enrolled in the certificate. While the number seems low, relatively speaking, many students in engineering technology take a sustainability course (one of the six offered), which is a requirement for their major. This is one way the enrollment in the courses has increased. Another key note, two of the faculty who initiated the certificate have left the university. However, one is still teaching and updating courses as an adjunct faculty. Another faculty member lost interest in the certificate courses and has gone on to teach in another area. The certificate is now overseen by the Technology Leadership and Communication (TLC) Department, where it should get more visibility.

7 Conclusions

The certificate has not increased in numbers as the faculty had hoped. However, given the state’s mandates for total number of credit hours in a major, certificates generally do not do well unless a large number of the courses in the certificate are required for the major. This is not the case with these courses. Many of the certificate students are from the School of Public and Environmental Affairs (SPEA), because the curriculum in SPEA is mainly focused on public policy and not sustainable technology. In

addition, the certificate attracts students in the Organizational Leadership major, where students need a foundation of technical credits in their degree program. A very small number of engineering students have completed the certificate due to the nature of the technical credits in that program being prescribed by their programs. Faculty need to outreach to the counselors in the engineering technology and engineering departments to help increase the numbers applying for the certificate. In addition, reaching out to continuing educational program and the SPEA counselors. The certificate is advertised on the website of the Sustainability Office at IUPUI. Faculty see the numbers increasing so the certificate should continue to grow.

References

Anderson, R. 2011. Business Lessons from A Radical Industrialist. St. Martin's Press.

Carson, R. 1990. Silent Spring. Houghton Mifflin Co. New York, NY.

Commercial Café. 2019. "Top 50 US Cities ranked by progress of Urban Sustainability." <https://www.commercialcafe.com/blog/urban-sustainability-us-progress-top-50-cities/>

Citizen Centric Cities. 2018. The Sustainable Cities Index, 2018. https://www.arcadis.com/media/1/D/5/%7B1D5AE7E2-A348-4B6E-B1D7-6D94FA7D7567%7DSustainable_Cities

Ellis-Ramkin, P. 2012. In Indianapolis, Green Economy Takes Root. Huff Post GREEN. December 12, 2012. http://www.huffingtonpost.com/phaedra-ellislamkins/in-indianapolis-green-economy_b_2207420.html

IUPUI. 2020. IUPUI website. <https://www.iupui.edu/about/index.html>

Light, J. 2013. "12 Cities Leading the Way in Sustainability." Moyer and Co. January 4, 2013. <http://billmoyers.com/content/12-cities-leading-the-way-in-sustainability/>

Stofleth, Danny. Feb 23, 2015. A Short History of Sustainable Development in the U.S., Rethinking Prosperity. <http://rethinkingprosperity.org/a-short-history-of-sustainable-development/>

Wikipedia. Indiana State Solar Power. 2019. Indiana. https://en.wikipedia.org/wiki/Solar_power_in_Indiana

Wikipedia. Indiana State Wind Power. 2019. https://en.wikipedia.org/wiki/Wind_power_in_Indiana

Towards a Sustainability-Centred Design Curriculum in Civil Engineering

Thomas M. Froese¹, David N. Bristow¹ and Keagan Rankin²

¹Department of Civil Engineering, University of Victoria, Victoria, B.C. Canada

froese@uvic.ca

²Department of Civil Engineering, University of New Brunswick, Fredericton, New Brunswick, Canada

Abstract

To improve the green engineering and active learning of the civil engineering program at the University of Victoria, Canada, we are developing a design spine: a series of courses running throughout the program with major design activities based on a sustainability-centred design approach. This paper describes our design spine approach and presents a conceptual framework for sustainability-centred design that we are developing. The framework organizes both the subjects of design and of sustainability into four high-level categories: 1) foundations, 2) frameworks, 3) tools and techniques, and 4) application areas. We have piloted the design spine approach in a second year course on sustainability.

1 Introduction

A new civil engineering program was created at the University of Victoria, Canada, in 2012 with the goal of being the greenest civil engineering program in Canada. Since that time, we have established a new department of 16 faculty members and graduated several cohorts of civil engineering students. So, although it is still a relatively recent curriculum, there is already enough evolution of faculty members and experience with delivering the program to warrant a strategic curriculum revision, which we call our “Curriculum 2.0”. Two broad strategic objectives are central to these curriculum changes:

1. to excel in green civil engineering and
2. to embody progressive teaching and learning practices such as problem-based learning or other appropriate active learning styles.

The department carried out several strategic planning activities to develop an approach to these objectives, considering alternatives from instructor development only with no changes to the overall program, to wholesale changes that delivered the majority of the program in non-traditional formats. The resulting strategy is between these two extremes. The focus on green civil engineering is anchored by a theme of sustainability-centred design: an approach to engineering design that places sustainability firmly at the centre of the design process. The focus on active learning involves programmatic changes, but it concentrates these changes into a “design spine”: a program curriculum that will add a major design project into one existing “anchor” course in each term, with integrative links into several other courses in each term and with a coordinated body of design content and project-based teaching and learning practices that provide the scaffolding to link these anchor courses throughout the program.

Several others have explored a design spine approach (Carrick and Czekanski, 2017; Frank et al., 2013; Gary et al., 2013; Lulay et al., 2015; Sheppard and Gallois, 1999). Our implementing of a design spine strategy involves three main elements:

1. an overall approach and set of learning activities for delivering the design projects in a consistent way throughout the program,
2. a body of content relating to engineering design that can run throughout the program, and
3. a curriculum map that identifies the design anchor course and the supporting courses in each term, suggests how the learning activities will integrate with the existing course content and formats, and lays out how the design content is distributed across these courses.

This paper first describes these elements, and then describes our first pilot implementation of a design spine course. While much work has been done to date, we are still in early development stages and have yet to complete fully-detailed curriculum development or research studies of the results.

2 Features of the Design Spine

In the 4-year civil engineering undergraduate program at the University of Victoria, the first year is common to all engineering students, the 2nd and 3rd years are mainly core courses, and the 4th year includes many technical electives and a final year capstone course. In keeping with the focus on green civil engineering, the program includes green courses that are less traditional in civil engineering programs—such as sustainable development, environmental policy, and building science and energy—as well as more traditional civil engineering courses that have been adjusted to have emphasis on green engineering issues.

Within this overall program, the objectives for the design spine initiative are to include more substantial active learning and problem-based activities, and improve learning of engineering design with an emphasis on sustainability. The approach is to include one major team design project in an “anchor” course in each term. Some of the other courses in each term will play supporting roles to these design activities (for example by using the same scenarios or case studies in their assignments), but these will be fairly “loosely-coupled” relationships so that the courses do not become too highly interdependent. The design projects will aim to have a number of smaller submissions that require team collaboration and discussion, rather than a large submission at the end of term that encourages teams to divide the work and complete it individually. Activities will be developed to promote teamwork, project management, and other targeted graduate attributes. The projects will involve the application of the technical material of the host course, but they will also involve the explicit application of sustainability-centred design, based on a body of content that is introduced in the first year and is expanded and reinforced in each cycle of the design spine course.

The following section introduces our approach to the content while Section 5 provides an illustration of the overall approach by describing a pilot implementation.

3 Sustainability-Centred Design

3.1 Development Approach and putting sustainability at the Centre of the Design Process

In addition to a plan for implementing the design spine as a series of learning activities across a range of courses, we also required a foundational body of knowledge, or course content, to be delivered throughout the design spine courses with some degree of consistency, repetition, and scaffolding from the beginning of the program through to the end. Both design and sustainability are topics that arise frequently through our civil engineering curriculum, yet neither is a major traditional sub-discipline of civil engineering with well-established curricular content. During the summer of 2019, we conducted an undergraduate research project to collect and organize ideas for this content. This project identified a wide range of topics and organizational approaches relating to engineering design and to sustainability.

For design, one topic of particular interest was design-thinking and the way that this body of thinking suggests both conceptual and specific techniques for putting users at the very core of the design process (as opposed to being just one of a long list of considerations in a “design for-X” approach (Dym, 2005; Roe et al., 1969). We adopted an approach of taking a similar position, except that we wanted to find ways of bringing sustainability to the core of the design process: hence, *sustainability-centred design* rather than user-centred design.

For sustainability, we grouped the wide range of topics into four high-level categories: 1) foundations—knowledge from other disciplines that are important for understanding sustainability issues, 2) frameworks—key conceptual models or perspectives for understanding and addressing sustainability, 3) tools and techniques—specific practices or analysis related to sustainability, and 4) application areas—topics related to sustainability applied to a specific field or discipline.

After many cycles of collecting and organizing both design and sustainability topics, we found that these four high-level categories can apply not only to sustainability knowledge, but to design knowledge as well. This led to a central model that provides an underlying structure for organizing a very broad range of topics related to both design and sustainability, the *sustainability-centred design model*.

3.2 Sustainability-Centred Design Model

Figure 1 depicts the sustainability-centred design model. The model is used as a high-level structure for organizing the wide range of topics that make up design and sustainability.

1. **Foundational Sciences and Systems:** The foundational sciences and systems are topic areas that are not themselves design or sustainability, but they provide the critical background understanding necessary for sustainable design, similar to the way that mathematics and physics provide critical foundational sciences for many areas of engineering. For design, the foundations emphasize the engineering science and design required to understand and solve the particular problems at hand. For sustainability, foundations include topics like ecology (as a science based on “holistic” or systems models as opposed to sciences such as physics that tend more towards “reductionist” models). Sustainability foundations also include the key systems related to planetary boundaries (Steffen et al., 2015): climate, water, energy, biodiversity, etc.
2. **Frameworks:** Ways of thinking about and approaching problems and solutions. For design, key frameworks include design processes and design principles. They address concepts such as convergent and divergent thinking, prototyping and iteration, etc. For sustainability, core frameworks might include approaches such as systems thinking, lifecycle thinking, etc.

3. **Tools and Techniques:** The “toolbox” of practices that can be used during design and sustainable engineering. Examples relating to design include requirements-capture techniques, rapid prototyping approaches, analysis of cost, risk or other “design for X” considerations. Examples relating to sustainability include life cycle assessment, LEED and other sustainability certification systems, etc.
4. **Implementation Areas:** The final layer includes topics that are not general to design and sustainability, but are rather unique to specific application areas. For design, these could include disciplinary codes and regulations, or contracting and other project delivery practices. For sustainability, these could include techniques used in high-performance buildings, energy systems modelling, or any other application area.





	Design	Sustainability
Foundational Sciences and Systems 	Engineering Science and Design.	Ecology, Biology, Chemistry, Key constituent systems of: climate, water, energy, biodiversity; the social dimension.
Frameworks 	<i>The Design Process and Design Principles:</i> Convergent/ divergent thinking, iterative loops, etc.	<i>Ways of Approaching Problems:</i> Systems engineering, life cycle thinking.
Tools and Techniques 	<i>Design Activates:</i> Requirements capture, rapid prototyping, design for X, etc.	<i>Modeling, Analyzing, Assessing Solutions:</i> Sustainable Rating Systems/Codes, Cradle to Cradle, LCC/LCA, etc.
Application Areas 	<i>Application of design to specific disciplines:</i> Codes and regulations, project delivery practices, etc.	<i>Sustainability Application Areas:</i> Green buildings, clean energy, sustainable software, etc.

Figure 1: Sustainability-Centred Design Model.

4 Positioning the Design Spine within the Program Curriculum

The design spine is being implemented in one main host course within each term of the civil engineering program. The tentative plan for these host courses is as follows:

- Terms 1A and 1B: First year engineering design courses
- Term 2A: Engineering graphics course
- Term 2B: Sustainability in civil engineering course
- Term 3A: Environmental engineering course
- Term 3B: Steel and timber design course
- Term 4A and 4B: Capstone design course

While each term will refer to the overall sustainable design framework, different terms will have a particular emphasis on portions of the framework. Figure 2 illustrates the framework portions that will be of primary and secondary emphasis in different terms.

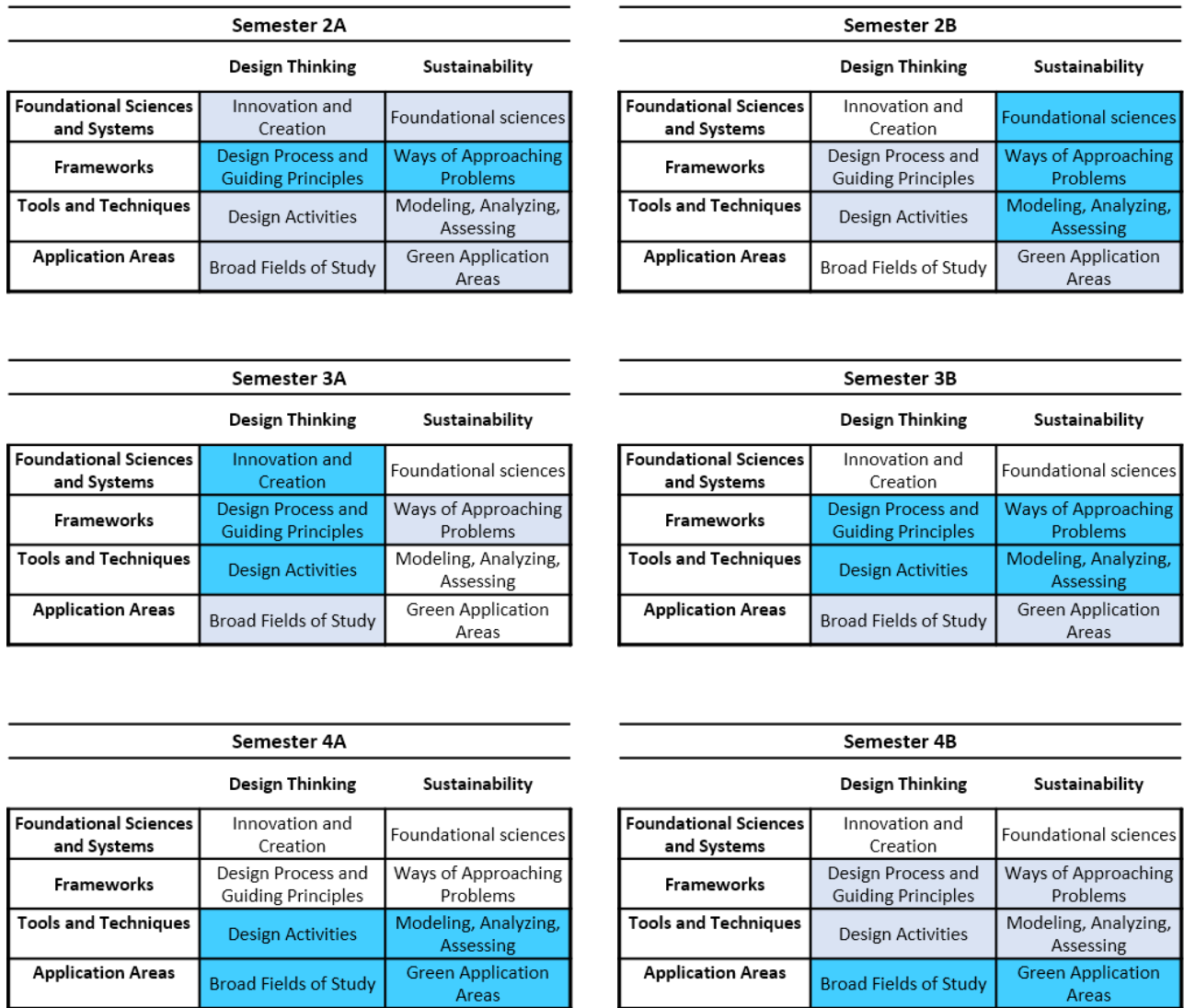

Figure 2: Scaffolding the sustainability-centred design model across the four-year program. Within each semester, the darker shaded topics are a primary focus area and the lighter shaded topics are a secondary focus.

5 Implementation

The pilot host design-spine course was the summer 2019 offering of our core course in sustainability in civil engineering. This course introduces additional foundational sciences of sustainability, such as ecology, planetary boundaries, socioeconomic metabolism and the fundamentals of resource extraction, by expanding on knowledge from an earlier core course in earth systems science (climate, geology, etc.). Systems thinking is introduced as the core framework for examining issues of sustainability. With a systems

lens, tools and techniques of sustainability assessment are studied, such as basic thermodynamics, life cycle assessment, material flow analysis, and various footprinting techniques.

The revamped design-spine version of the course resulted in several changes. This includes revisiting generic design processes and design activities, building on courses from first year. The design aspects of the course are framed within the context of a new group-based design project and the inclusion of group-based exercises. The exercises and project work in tandem.

The exercises provide in-class problem-based use of the sustainability frameworks, tools and techniques, in order to progress student learning in advance of each stage of the design project. The group-based project, conversely, centres on the use of the design thinking frameworks and techniques to deliver a suite of design alternatives to an applied sustainability challenge. In the prototype offering of the design project the ask is to first assess and then propose low impact neighbourhood designs for a re-development area in Vancouver, Canada. The project includes several features designed to meet our curriculum change objectives: realistic problem-based coursework that is broken-up throughout the term and is supported by providing students with pre-existing engineering materials and data with which to create their designs.

The term project is divided into five assignments distributed throughout the term. The first three assignments concern the use of sustainability tools within the application area of green buildings. From CAD drawings and additional supporting data for a real building students are required to (1) calculate the use of energy over the supply-chain; (2) conduct a partial quantity take-off estimate for use as inputs to (3) a detailed life cycle assessment. In assignments four and five, the students first create high-level design alternatives for the re-development area using details of archetypal buildings from the 2011 National Energy Code of Canada and then they evaluate the sustainability outcomes of their designs using a decision matrix approach. The five assignments are graded and submitted throughout the course. For the fifth submission, all the previous assignments are compiled into a single report along with recommendations to a hypothetical client. The project concludes with group presentations, a group reflection and an individual peer review of group members.

This prototype also involves changes to support the concept of a design-spine hub course loosely integrated with other core courses offered within the same term. The integration in this offering occurs with our building sciences fundamentals course and our civil engineering materials course. The connection with the building sciences course is through the systems-based framework. In this course the students assess energy flows and balances of buildings. The building science course also provides students with a view to how techniques in that course are used to arrive at greener building designs. For the materials course the linkage is made through life cycle assessment and the neighbourhood design. While students conduct an LCA of buildings in the sustainability course, they conduct an LCA of pavement alternatives in the materials course. This affords an opportunity to consider alternative pavements within the neighbourhood design, though the project stops short of requiring this consideration formally. Instead, this consideration is examined through the final reflection in the design-spine course. The reflection also requires students to adapt methods from the building science course to further reduce buildings' environmental impacts on neighbourhood designs. In this way, the design-spine offering connects learning across three disciplines to further support a systems-based mentality.

This first design-spine course has been assessed at a high-level by the students (Figure 3). The students rank the project as a core aspect of the course they think should be kept. Interestingly, in this regard, the

project was second only to the in-class exercises (when the feedback related to projects is added – see items with an * in the figure). In effect this means the two largest changes made to support the design-spine – the project and the exercises – are the most favoured aspects of the new version of the course. In future design spine offerings we plan to formalize our student feedback assessment by focussing survey questions in terms of the relationship of lectures, assignments and tests to the students’ own perceived effectiveness in design and sustainability.

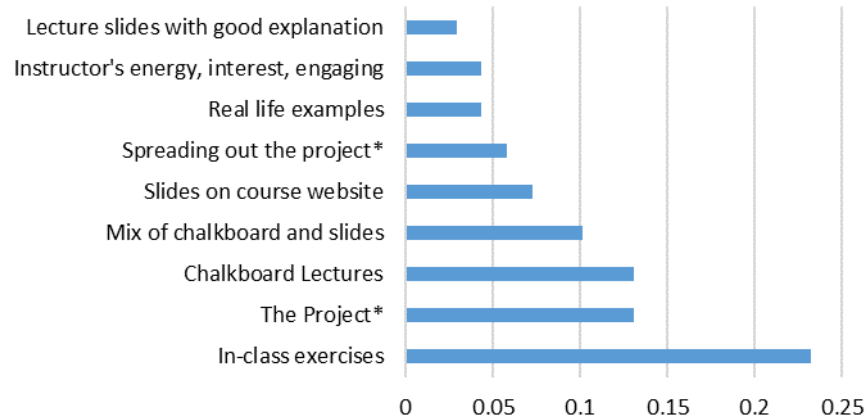

Figure 3: Frequency of Student Replies to the Question “What should the instructor keep doing?”

6 Conclusions

We have developed a design spine strategy as a program-level curriculum improvement approach motivated by two primary drivers: a desire to improve our sustainable design content, and a goal of improving our active learning practices. The design spine will implement one major design activity within a host course in each term of our civil engineering program. We are developing a sustainability-centred design model as a anchoring framework for the sustainability and design content that we will be including in the design spine courses. The model is based on four high-level categories of foundations, frameworks, tools, and applications. We have completed a pilot implementation of our design spine approach, and found that students had a very favourable reaction to the design activities. In future work, we will continue to refine the design spine activities, develop the sustainability-centred design content, and implement the strategy in a number of other courses through our civil engineering program.

References

- Carrick, R., Czekanski, A., 2017. Preparing Students For Success Through Implementation Of A Unified Curriculum Design Spine. Proc. Can. Eng. Educ. Assoc. CEEA.
- Dym, C.L., 2005. Engineering Design Thinking, Teaching, and Learning. J. Eng. Educ. <https://doi.org/10/gd23pm>
- Frank, B., Strong, D., Sellens, R., Clapham, L., 2013. Progress with the professional spine: A four-year engineering design and practice sequence. Australas. J. Eng. Educ. 19, 63–74. <https://doi.org/10/ggkwvh>

- Gary, K., Lindquist, T., Bansal, S., Ghazarian, A., 2013. A project spine for software engineering curricular design, in: Software Engineering Education and Training (CSEE&T), 2013 IEEE 26th Conference On. IEEE, pp. 299–303. <https://doi.org/10/gf8k>
- Lulay, K., Dillon, H., Doughty, T.A., Munro, D.S., Vijlee, S.Z., 2015. Implementation of a design spine for a mechanical engineering curriculum. <https://doi.org/10/ggkwvc>
- Roe, P.H., Soulis, G.N., Handa, V.K., 1969. The Discipline of Design. Waterloo, Canada.
- Sheppard, K., Gallois, B., 1999. The design spine: Revision of the engineering curriculum to include a design experience each semester, in: American Society for Engineering Education Annual Conference Proceedings.
- Steffen, W., Richardson, K., Rockström, J., Cornell, S.E., Fetzer, I., Bennett, E.M., Biggs, R., Carpenter, S.R., De Vries, W., De Wit, C.A., 2015. Planetary boundaries: Guiding human development on a changing planet. *Science* 347, 1259855. <https://doi.org/10/f3m6n9>

Using field trips in engineering education to facilitate the understanding of energy systems and technologies: an overview

L. Gast¹

¹Department of Engineering, University of Cambridge, United Kingdom

Abstract

Can field trips provide a more efficient way of teaching energy systems and technologies at the university level? This paper provides an overview of how field trips could be used to teach students the fundamentals and complexities of energy systems and energy technologies. It contains an overview of learning objectives related to the UN Sustainable Development Goal 7 (clean and affordable energy) as well as teaching methods that could be used during a field trip programme. This paper uses the findings of five weeklong field trips for university students as a case study to shed light on the benefits of such an educational experience. These visits included visits to production sites, governmental and corporate stakeholders of the energy system in different regions in Germany. The paper then proposes a schedule for a multiple-day field trip and suggests a general programme in four categories (political institutions, production sites, civil society and research institutions) for a better understanding of energy systems and technologies.

Keywords: field trips, engineering education, energy systems, energy transitions, community-based learning

1 Introduction

Visits to industrial production sites and organisations have been part of the university-level engineering curriculum for decades. Field trips are a component of engineering education and provide an important extension to the engineering curriculum. They facilitate an understanding of how engineering challenges are addressed in practice and bring students in contact with technologies and current challenges in industry. Broman (1994) describes two major contributions of field trips: firstly, they create an interest in the subject itself and secondly, they provide “sufficient connection with the real world to facilitate students' use of their knowledge”. Further examples include teaching plant and process safety to chemical engineers (Amaya-Gómez et al., 2019) as well as in the education for energy managers (Ciriminna et al., 2016). These visits can also be used to show how sustainability principles can be incorporated and to stimulate discussions whether such approaches can be scaled up and scaled out (Fenner et al., 2014).

Major recent review papers of engineering for sustainable development and reviews of teaching methods for engineering refer to field trips as one option for extending lectures: for example, Nesbit et al. (2013) mention project-based learning and field trips as possible methods in their comparison of “Educational Principles for Engineering Education for Sustainable Development”. Similarly, field trips are mentioned as a method to teach circular economy (CE) principles (Kirchherr and Piscicelli, 2019). Lozano et al. (2017) review pedagogical approaches in higher education and explain how they affect sustainability competences. They describe various teaching methods (case studies, inter-disciplinary team teaching, lecturing, project-based learning, community service learning, participatory action research among others). Overall, they describe several elements, but do not include the concept of field trips in their list of teaching methods.

Case studies of field trips, the learning outcomes, teaching methods and educational approaches have occasionally been presented at EESD conferences. Key features include a better understanding of manufacturing technologies and their implementation, direct contact with industrial companies, as well as discussions with stakeholders. However, descriptions and case studies of field trip-based learning experiences are rarely published in engineering education journals (but inform the writing process of them). The details of the planning of a field trip, the learning objectives and potential items of a programme of a multiple-day field trip are, however, not described further in these papers and the literature on multiple-day field trips is sparse in the published literature on engineering education. This might provide an opportunity for further work in this area. Further research could also include a more systematic review of literature on field work and site visits (including other disciplines such as geology).

The goal of this paper is to shed light on how these educational programmes could facilitate the understanding of the complexities associated with the Sustainable Development Goal (SDG) 7 “Clean and Affordable Energy for All”. Based on a case study of five one-week field trips that were conducted in Germany, the paper will address the following two questions:

1. What are the factors to consider when designing a field-trip based learning experience related to energy and the energy transition?
2. How can the complexities of an energy system, including technologies, systems, stakeholders and transitions be taught to students during a field trip?

There are different options for including field trips into the engineering curriculum with a duration ranging from a couple of hours to multiple days. This case study describes options for including energy-themed site visits into a week-long field trip programme around issues of the energy transition in Germany. Five independent week-long field trips were conducted between 2016 and 2019 in different regions in Germany with groups of 20-25 students per trip from different disciplines. The field trips were funded by the Studienstiftung (a German educational foundation). The visited organisations which included governmental and non-governmental stakeholders, production sites, power plants, research institutions, and museums. An example schedule is provided in Table 4 in the Appendix.

The field trips were followed by discussions and reflections in the team of organisers which were used systematically to summarise and analyse lessons learned for organising field trips and designing the learning experience. Over the five field trips, the programme items and aspects of “good practice” were identified and continuously improved. The findings from the field trips organised were extended by a literature review on the published examples of field trips in engineering education. These were then summarised for this conference paper to highlight the potential contributions and learning outcomes of field trips.

In the next section, the potential contributions of field trips in engineering education and methods used during field trips will be summarised. Then, the energy field trip programme and some anecdotal evidence of findings that highlight the benefits of this teaching experience are presented.

2 Field trips for exploring aspects of the *Energy System Transition*

2.1 Potential contributions and learning outcomes of field trips

Field trips could help to systematically teach and analyse engineering challenges such as the transition towards renewable energy sources, and the stakeholders involved in addressing the challenges on a societal level. The learning outcomes can be divided into learning outcomes relevant for all engineering disciplines, and learning outcomes specific for a better understanding of SDG 7. Field trips can be used to expand the technical knowledge, the political and economic relevance of energy topics.

Technical dimension:

- teach students which processes are currently used in industry and facilitate an understanding of how the theoretical knowledge (e.g. combustion processes, heat transfer) is applied in technologies in practice,
- show and assess the difficulties of scaling up and out (e.g. renewable energy sources such as wind turbines or solar panels),
- highlight technological alternatives and their similarities and differences (e.g. different material demand and/or different efficiencies).

Economic dimension:

- show how engineering and technology are embedded in society and show the diversity of stakeholders in the energy system,
- bring students in contact with potential employers after graduation (e.g. small and large corporate, governmental, and research institutions),
- facilitate an understanding of the scale of production sites and the lock-in into current capital-intensive production equipment (e.g. power plants).

Socio-political dimension:

- facilitate a discussion about the challenges of long-term actions that require coordination between different stakeholders,
- help to understand the challenges of policy implementation (e.g. political processes and barriers) and help to inform better policy conclusions from research papers and reports.

The report on Education for SDGs by UNESCO (2017) provides an overview of the SDGs and the learning objectives in three categories: cognitive, socio-emotional and behavioural learning objectives. Table 1 provides an overview of the learning objectives related to SDG 7. The learning objectives from UNESCO (2017) were extended with further learning objectives and suggestions for programme items based on the findings during the field trips.

The table shows that most of the learning objectives can be covered during site visits or workshops as part of a field trip programme. In addition to the three main categories, further energy-related learning objectives were identified. These are the sociocultural, economical and historical embeddedness of stakeholders of the energy system. Furthermore, the institutional arrangements and relevant stakeholder companies, civil organisations as well as governmental institutions and their role in shaping energy systems can be taught through the site and organisation visits.

Table 1: Learning objectives related to SDG 7: clean and affordable energy as described in UNESCO (2017) with an example and the suggested duration if included in a field trip experience.

Learning Objective	Description from UNESCO (2017)	Examples	Suggested Duration
Cognitive learning objectives	1. The learner knows about different energy resources – renewable and non-renewable – and their respective advantages and disadvantages including environmental impacts, health issues, usage, safety and energy security, and their share in the energy mix at the local, national and global level.	Visits of coal mine, wind turbine, biogas plant, coal- or gas-fired power plant.	4-8h
	2. The learner knows what energy is primarily used for in different regions of the world.	Lecture or presentation, seminar with overview, introductory reading material.	1-3h
	3. The learner understands the concept of energy efficiency and sufficiency and knows socio-technical strategies and policies to achieve efficiency and sufficiency.	Discussions with stakeholders, site-visit and seminars.	2-4h
	4. The learner understands how policies can influence the development of energy production, supply, demand and usage.	Discussions with stakeholders, and visits of political organisations.	1-3h
	5. The learner knows about harmful impacts of unsustainable energy production, understands how renewable energy technologies can help to drive sustainable development and understands the need for new and innovative technologies and especially technology transfer in collaborations between countries.	Company visit, production sites, discussions during and after site visits.	1-3h
Socio-emotional learning objectives	1. The learner is able to communicate the need for energy efficiency and sufficiency.	Seminars with reflective elements and documentation of the field trip.	1-6h
	2. The learner is able to assess and understand the need for affordable, reliable, sustainable and clean energy of other people/other countries or regions.	Seminars and workshops with interactive discussions.	1-4h
	3. The learner is able to cooperate and collaborate with others to transfer and adapt energy technologies to different contexts and to share energy best practices of their communities.	Seminars and workshops with interactive discussions.	1-4h
	4. The learner is able to clarify personal norms and values related to energy production and usage as well as to reflect and evaluate their own energy usage in terms of efficiency and sufficiency.	Site visit with follow-up discussions, and workshops.	2-8h
	5. The learner is able to develop a vision of a reliable, sustainable energy production, supply and usage in their country.	Seminars and workshops with interactive discussions.	2-4h
Behavioural learning objectives	1. The learner is able to apply and evaluate measures in order to increase energy efficiency and sufficiency in their personal sphere and to increase the share of renewable energy in their local energy mix.	Seminars and workshops with interactive discussions.	2-4h
	2. The learner is able to apply basic principles to determine the most appropriate renewable energy strategy in a given situation.	Seminars and workshops with interactive discussions.	2-4h
	3. The learner is able to analyse the impact and long-term effects of big energy projects (e.g. constructing an off-shore wind park) and energy related policies on different stakeholder groups (including nature).	Coal mine or production site visit and discussions with stakeholders.	2-8h
	4. The learner is able to influence public policies related to energy production, supply and usage.	Workshop and interactive discussions with political stakeholders.	2-4h
	5. The learner is able to compare and assess different business models and their suitability for different energy solutions and to influence energy suppliers to produce safe, reliable and sustainable energy.	Site visits with interactive discussions, seminars and workshops .	2-8h
Additional contextual learning objectives	1. The learner understands the historical context of the local energy system.	Museum visits and discussions with stakeholders.	1-3h
	2. The learner understands the limitations and potentials for scale-up and scale-out.	Seminars and workshops with interactive discussions.	1-3h
	3. The learner knows the political and institutional arrangements in a local context.	Visit of governmental institution, discussion with political stakeholders.	1-4h
	4. The learner understands the use of energy in industrial production processes and manufacturing and potential improvements with regard to material and energy efficiency.	Production site and company visits, documentation of site visits and short technical analysis (e.g. energy and material balance).	2-8h
	5. The learner understands the local importance of companies and production sites as employers and tax-payers –and potential constraints for an energy system transition.	Production site and company visits.	2-8h

2.2 Teaching methods

Various teaching methods can be used during engineering field trips. These include methods commonly used in engineering education, field trip specific methods and other methods for documenting and reflecting on the learning experience. The teaching methods range from visits to production sites to semi-structured interviews and typical teaching formats of the university curriculum (including presentations, seminars, and workshops). Table 2 summarises a selection of these teaching methods, a brief description, the contribution to the learning outcomes as well as an example and estimate of the time for execution and preparation.

Table 2: Overview of teaching methods that can be used in multiple-day field trips

	Teaching Method	Description	Contribution to the Learning Objectives	Example in Field Trip	Time of Method	Time for Preparation
During site visit	Production site visit	Group visits to production sites with production processes or engineering equipment. These could include power plants, manufacturing companies or bulk material production process.	Understanding of the production process, historical developments, current processes and limitations to changing them. Understanding the application of engineering knowledge in practice.	Guided tour through a coal-fired power plant or steel production site.	2-8h	1-4h
	Research institution visit	Group visits to a large research institution or research unit of a company. The focus could be on the understanding of current and published research (presentations) or the tools methods for doing research in this area (laboratory visit, software demonstration), and discussing current activities.	Overview of current research topics, methods and questions.	Major research center (e.g. Fraunhofer) or university department.	2-8h	1-4h
	(Audio-) Guided tour in cultural institution	(Audio-)Guided tour in a cultural organisation or place. This includes museums, exhibitions as well as other significant places (e.g. former mines).	Overview of energy systems over time, historical relevance of production sites and technologies; cultural aspects of energy technologies.	Local museum or exhibition on energy-related topics (science and technology museum, history of the region).	1-4h	1-2h
	Semi-structured interview	Semi-structured interview with a stakeholder. The prepared questions provide a general frame and set the stage. The spontaneous questions of students to clarify points and allow an interactive discussion.	Understanding complexities and diversity of stakeholders involved in energy systems, political processes and organisations.	Interview with a representative of a political institution; current or former member of a parliament.	1-4h	1-6h
Directly before or after the visit	Presentation and discussion	The presentation could be on research topics and projects, practitioners' insights or a general overview of a topic. The presentation is similar to a lecture, but could provide further insights if given by a local stakeholder. The presentation should be limited to 45min in order to allow for sufficient time for questions and discussions.	Overview of a topic and insights into practical challenges and how to address them.	Presentations by engineers working in project management, civil servants, journalist, or researchers.	1-4h	1h
	Movie	A movie screening (with a movie related to energy) could help to provide some time to relax and a passive acquisition of contextual knowledge. Movies, especially documentaries, could provide additional perspectives and could be used as a reference point in discussions with stakeholders.	Visual overview and information on topics that can not be covered in site visit or common presentation.	Movie on biofuel production and its effects on agriculture.	1-2h	–
	Seminar	A seminar can be included in the programme to prepare a site visit, to reflect on the visit and to discuss open questions.	Process understanding, room for asking questions and identifying further research questions or information needs.	Seminar preparing and reflecting on site visit.	1-2h	1-6h
	Workshop	An interactive workshop can be used for group exercises, role play and simulation games.	Problem-based learning; interactive discussion of possible improvements in a production site to increase energy efficiency or sustainability.	Workshop on "Tragedy of the Commons".	1-8h	1-20h
Before or after the field trip	Travel and discussions	Travel with different means of transport (walking, cycling, train, bus) to go to the next station in the programme (e.g. production site or research institutions) and to facilitate conversations among participants.	Required for getting to programme items. Different means of transport can be used for reaching the destination.	1.5 hour-long journey to a remote production site.	1-2h	–
	Reading material	Material could be provided before and during the field trip. These could include journal articles, newspaper and magazine articles. Additionally, technical reports and governmental reports could provide an overview and show students examples of grey literature on energy.	Better understanding of the visited stakeholders, understanding of literature and sources of information; relevant information sources out of the "academic" literature.	Technical or research reports on programme items or energy-related topics, governmental regulation.	1-15h	1-2h
	Meeting before the field trip or follow-up meeting	The trip could be extended by a pre-meeting or a post-meeting. The meeting can take place physically or as a virtual meeting. This can be used for preparing the field trip, facilitating exchange among participants, discussing site visits and implementing ideas that resulted from the field trip.	Team-building before the trip and to bring all participants on a similar level of knowledge.	Physical preparation meeting before the field trip or phone conference.	1-8h	1-20h
	Documentation and reflective exercises	The participants can be encouraged to take notes of one programme item and to document the visit. The notes can then be summarised, extended and compiled into a report for all participants.	Mandatory reflection and encouraging note-taking during the site visits and discussions.	Summary of site visit, collection of questions and answers.	1-20h	1h

Further methods that could be included in a multiple day field trip are case study field work, learning-by-discovery and project-based learning (Ciobanescu and Ertekin, 2018). Seifan et al. (2019) propose the inclusion of *virtual* field trips (with virtual reality glasses) to prepare for a *real* field trip. Recent developments resulting from the lockdowns during the Covid pandemic have led to several innovations and opportunities for virtual site visits. These could be explored in further research.

3 Programme items and lessons from the field trips

A field trip on energy topics could cover many different programme items. This section summarises four main categories of stakeholders and three examples of learning outcomes that illustrate the complexities and how a field trip can be used to facilitate a better understanding of them.

The stations and stakeholders that can be included in a field trip programme very much depend on the local context, the time and resources available. The stakeholder institutions, which were visited during the previously conducted field trips, can be divided into four broad categories: (1) political institutions, (2) companies and production sites, (3) civil society and NPOs as well as (4) research institutions and other public institutions. There are, however, more stakeholders in the energy system which could be identified in a more detailed systems analysis, e.g. as described in Meadows and Wright (2009).

Table 3 provides an overview of stakeholders and production sites that could be visited to gain a more holistic understanding of the energy system.

Table 3: Overview of stakeholders in the energy system and potential programme items of an energy-themed field trip in Germany

Political Institutions	Production Sites and Company Visits	Civil Society and Non-Profit Organisations (NPOs)	Research Institutions and Other Public Institutions
Government (local, national, international)	Production and manufacturing companies	Environmental NGOs/NPOs	Universities and technical colleges, other educational institutions
Politicians	Power plants	Other local civil society actors	Research institutions (Fraunhofer, Max-Planck, Helmholtz, Leibniz)
Public agencies (e.g. Environmental Agency)	Engineering offices, transport planning company	Grass-root initiatives	Research unit or laboratory in company
Administration	Other (financial institution, start-ups)	Citizens	Museums

The field trips all included at least one stakeholder from each group to provide a broad overview of the technological, economical and sociocultural aspects of energy systems. These different stakeholders are summarised in Table 3. Between the production site and stakeholder visits, there was time for seminars to prepare for the visits and to reflect on the visits in discussions. These discussions led to helpful insights into the non-technical aspects of energy system transitions.

Three examples from the visited stations illustrate the non-technical aspects; the context, the complexities and the diversity of stakeholders involved in decision-making:

1. **The embeddedness of a power plant in its environment.** A visit to a power-plant shed light on the technologies and fuels used for generating electricity and heat. These products are used by *companies* and *households* nearby. To build and operate a power-plant, permissions from a *local*

governmental authority are required and the power-plant needs to meet the emissions requirements set by *national and international governmental institutions*. The power plant operator provides work for *employees* and pays *taxes* that finance local governmental spending.

2. **Local initiatives that can be scaled up.** A local municipality government (e.g. Stuttgart) developed an energy efficiency programme to reduce the energy demand throughout the governmental offices in a city, e.g. by demand reduction, buildings refurbishments and LED lighting. The programme followed national targets set by the parliament, but was implemented by the local administration. Due to its success, its best practice was shared and “scaled-out” to municipalities and cities of a similar size and with similar challenges. At the same time, the state-level government developed ambitious plans for GHG emissions reductions, which were later implemented into federal level legislation.
3. **The complexity of coordinating stakeholders involved in industrial waste heat utilisation.** Large industrial production processes often produce heat that is not used within the process, but could be used for district heating. In the city of Hamburg, a copper producer had waste heat that could be used for district heating, but there were budgetary constraints and legal challenges to the utilisation. In order to overcome the non-technical challenges of using the heat (e.g. planning and building the infrastructure, financing the project and ensuring district heat demand), the company had to coordinate the actions with local stakeholders. The company then cooperated with the local energy utility company, a governmental bank, and the local government to successfully implement the project.

These examples highlight major non-technical aspects of engineering solutions and how they are driven and shaped by political and corporate stakeholders. They could to some extent be taught in lectures and workshops, but site-visits with interactive discussions with the stakeholders might facilitate a better and more time-efficient understanding of the complexities.

4 Conclusions

This paper provided an overview of factors to consider when designing a multiple-day field trip for engineering students and contains a proposal of learning objectives, teaching methods and programme items. Field trips can provide additional benefits (compared to traditional university teaching methods) in three broad areas: firstly, they help to identify and illustrate non-technical aspects of energy systems. Secondly, they help to understand the complexities in energy systems, the diversity of stakeholders involved and the time lag of implementing new technologies. Thirdly, they provide visual insights and (anecdotal) evidence of the “real world challenges” in companies, research and governmental organisations. By acquiring the knowledge about the challenges and barriers, students might develop better engineering solutions to address and solve them.

Learning objectives, teaching methods and potential programme items for an energy-themed field trip were suggested based on the experience of organising energy-themed field trips in Germany. The stakeholders of energy systems that could be visited during a field trip can be divided into four categories: political institutions, production sites, civil society and research institutions. It is suggested that a field trip should contain one programme item from each of the categories to ensure a broad learning experience and to facilitate a better understanding of the challenges of the transition towards sustainable energy systems.

Acknowledgements and Remarks

The field trips that provided the foundation for this article were funded through the programme “SmP: Stipendiat*Innen machen Programm” of the Studienstiftung. Thanks to MW, MH, TB, AS, and DM for discussions, comments, and feedback on earlier drafts.

Further material that might be useful for implementing a field trip at university-level can be provided by the author on request.

5 References

- Amaya-Gómez, R., Dumar, V., Sánchez-Silva, M., Romero, R., Arbeláez, C., Muñoz, F., 2019. Process safety part of the engineering education DNA. *Educ. Chem. Eng.* 27, 43–53. <https://doi.org/10.1016/j.ece.2019.02.001>
- Broman, L., 1994. On the didactics of renewable energy education — drawing on twenty years experience. *Renew. Energy, Climate change Energy and the environment* 5, 1398–1405. [https://doi.org/10.1016/0960-1481\(94\)90179-1](https://doi.org/10.1016/0960-1481(94)90179-1)
- Ciriminna, R., Meneguzzo, F., Pecoraino, M., Pagliaro, M., 2016. Reshaping the education of energy managers. *Energy Res. Soc. Sci.* 21, 44–48. <https://doi.org/10.1016/j.erss.2016.06.022>
- Fenner, R.A., Cruickshank, H.J., Ainger, C., 2014. Sustainability in civil engineering education: why, what, when, where and how. *Proc. Inst. Civ. Eng. - Eng. Sustain.* 167, 228–237. <https://doi.org/10.1680/ensu.14.00002>
- Kirchherr, J., Piscicelli, L., 2019. Towards an Education for the Circular Economy (ECE): Five Teaching Principles and a Case Study. *Resour. Conserv. Recycl.* 150, 104406. <https://doi.org/10.1016/j.resconrec.2019.104406>
- Lozano, R., Merrill, M.Y., Sammalisto, K., Ceulemans, K., Lozano, F.J., 2017. Connecting Competences and Pedagogical Approaches for Sustainable Development in Higher Education: A Literature Review and Framework Proposal. *Sustainability* 9, 1889. <https://doi.org/10.3390/su9101889>
- Meadows, D.H., Wright, D., 2009. *Thinking in systems: a primer*. London [u.a.]: Earthscan.
- Nesbit, S., Cruickshank, H., Nesbit, J., 2013. Educational Principles for Engineering Education for Sustainable Development: Experiences from the UK and Canada q’.
- Seifan, M., Dada, D., Berenjian, A., 2019. The effect of virtual field trip as an introductory tool for an engineering real field trip. *Educ. Chem. Eng.* 27, 6–11. <https://doi.org/10.1016/j.ece.2018.11.005>
- UNESCO, 2017. *Education for Sustainable Development Goals: Learning Objectives*. United Nations Educational, Scientific and Cultural Organization, France.

6 Appendix

Appendix A

Table 4: Example schedule of a field trip on energy systems, technologies and transitions

Time	Day 1 (Sunday)	Day 2	Day 3	Day 4	Day 5	Day 6	Day 7 (Saturday)	
07:00	Arrival	Breakfast	Breakfast	Breakfast	Breakfast	Breakfast	Breakfast	
08:00		Travel Time	Travel Time	Travel Time	Travel Time	Travel Time	Breakfast	
09:00		Power Plant Visit (A)		Museum Visit	Production Site Visit or Company Visit (A)		Production Site Visit or Company Visit (B)	Discussion with Governmental Stakeholders
10:00								
11:00								
12:00		Lunch	Lunch (with Lunchbox)	Lunch (with Lunchbox)	Free Afternoon	Lunch	Departure	
13:00		Power Plant Visit (B) or Company Visit	Visit of a Research Institution			Travel Time		Dinner
14:00								
15:00				Warm-Up	Travel Time	Dinner		Seminar
16:00				Seminar				
17:00	Dinner	Dinner	Presentation / Movie	Seminar / Workshop	Dinner and Evening Programme			
18:00	Presentation	Presentation / Seminar				Student Presentations		
19:00								
20:00	Open Exchange	Open Exchange	Open Exchange	Open Exchange	Open Exchange			
21:00								
Overnight	Accommodation	Accommodation	Accommodation	Accommodation	Accommodation	Accommodation		

Embedding Sustainability in Engineering Education through Interactive Industrial Design Case Studies

Kevin Gibson^{a, b}, Dr Jorge C. Oliveira^{a, c}, Dr Denis T. Ring^{a, d},

^a Process and Chemical Engineering, School of Engineering, University College Cork, Western Road, Cork, Ireland

^b kevin.gibson@pmgroup-global.com

^c j.oliveira@ucc.ie

^d d.ring@ucc.ie, +353 86 6098733

Abstract

The need for the integration of industrial concepts and applications of sustainability in engineering education is a priority for universities and especially for engineering courses. To deliver the concepts and benefits of sustainable engineering design to students requires something more than just a theoretical overview. The use of case studies in engineering education is well established and a mature concept. The scope and criticality of sustainable development is increasingly complex and diverse and continues to change and adapt as the climate crises deepens.

The biotechnology industry is perhaps the youngest of all of the process industries and is changing and adapting rapidly. Combine these two changing dynamics and the result is a compelling argument for interactive design case studies.

The design of a manufacturing process within the biopharmaceutical industry is based on various criteria such as capital investment, operating costs, process reliability and safety with an overarching focus on patient safety. While environmental impact and sustainability is a critical area from a global perspective, it has not been a key consideration within the industry with relatively little research into the environmental impact of adopting different processes and technologies.

There is a growing demand for multiproduct, flexible facilities with approaches such as modular strategies facilitating easy adaptation for different processes. This places an increasing emphasis on support services such as buffer preparation, where overheads are increasing and bottlenecks are developing. The supply of buffer solutions in particular, accounts for a large proportion of a facility's footprint, labour, equipment and operating costs. To alleviate the potential bottlenecks, reduce the impact on capital and operational expenditure and improve sustainability, alternative philosophies for buffer management must be considered.

Buffer preparation offers an ideal opportunity for collaboration with case studies as it represents a common problem within the industry in a non-competitive space, which has a clear demand for fresh thinking. While there are significant variations in core process technology, buffer preparation remains a key aspect of facility design across differing modalities.

This research aims to demonstrate the benefit of exploring the industrial sustainability design space in conjunction with third level engineering education. This synergy will utilise Interactive Design Sessions utilising approaches such as Finite Capacity Analysis to demonstrate the environmental impact of operational strategy and technology utilisation (such as Single Use Technology and inline buffer preparation) on buffer preparation within the biopharmaceutical industry, highlighting the synergy between more sustainable production and a reduction in the cost of manufacturing.

Keywords: Engineering, Education, Sustainability, Biotechnology, Finite Capacity Analysis, Buffer Preparation, Flipped learning

1. Introduction

The environmental impact of the biopharmaceutical industry is significant given the considerable usage of water, energy and raw materials. The waste to product ratio of the biopharmaceutical industry can be as high as 10,000:1 which demonstrates extremely poor efficiencies when compared to the traditional chemical industries. (Martin, 2016)

Water usage is particularly challenging given the cleaning and sterilisation requirements necessary to meet the exacting regulatory standards. For a stainless steel facility, it has been estimated that around 100,000L of water is consumed per batch at the 2,000L Bioreactor scale. (Sinclair, Leveen, Monge, Lim, & Cox, 2008) Given the scale of the industry globally with more than 16.5million litres of active production capacity, the impact should not be understated. (Rader & Langer, 2018)

The advent of single use technology has resulted in considerable reductions in water usage globally, lowering the carbon footprint of biopharmaceutical manufacturing (Rawlings & Pora, 2009) (Pizzi, Flanagan, Pietrzykowski, & Brown, 2014). Despite the improved sustainability performance, there has been a consequential increase in the quantity of plastic waste generated by the industry. It is estimated that 30,000 tonnes of plastic waste are disposed of to landfill or incineration each year. (Ignacio, 2013)

The definition for sustainable development provided by the Brundtland Commission Report states “development that meets the needs of the current generation without compromising the ability of future generations to meet their own needs” (WCED, 1987). There are three core issues associated with sustainable development, economic growth, environmental protection and social equality. (Mensah & Casadevall, 2019)

The biopharmaceutical industry presents positive metrics with respect to societal sustainability with novel healthcare products, eradicating some very challenging medical conditions and increasing life expectancy. However the industry also has a large environmental impact. With an increasingly aging global population, demand for healthcare services including biopharmaceuticals is unprecedented (Paul Kowal, 2012). A key concern is the affordability of healthcare products. (Wise, et al., April 2018) Increased sustainability may be used to lower costs through resource efficiencies but also can act as a platform to drive innovation. (Biogen, 2016)

It is imperative that the business case for new technology and innovation is used to drive sustainable development. In the design of a manufacturing facility, key considerations are, capital investment, operating costs, process reliability and safety with an overarching focus on patient safety. Although environmental

impact and sustainability is a critical area of attention from a global perspective, it has not traditionally been seen as a high priority within industry.

Through the development of innovative technical solutions, the engineering profession will play a significant role in addressing the challenges associated with the climate crisis. This change in fundamental attitude needs to start within the education system. As a means of accelerating the influence of sustainability ideologies on industry and society, both parties must work closely together.

While sustainability in education is generally regarded as a priority for universities, manufacturing companies have raised concerns that sustainability has not yet effectively branched into mainstream chemical and biological science programmes. (Biogen, 2016) This highlights a gap in thinking between academia and industry, which must be bridged to accelerate change. Within the university environment, sustainability is regarded as the only priority, whereas within industry, wider economic and practical considerations must also be accounted for. For universities to foster an enhanced and genuine awareness of sustainable development requires closer collaboration with industry via the sharing of real world design issues.

This increased collaboration benefits industry with new generations of innovate engineers who have sustainability as an underlying principle guiding all design. This approach can drive innovation from the bottom up and also increases student's readiness for the workplace given the familiarity with real industry problems.

The use of case studies in engineering education is well established and a mature concept with a number of demonstrable benefits including increased critical thinking, connections across multiple content areas while fostering an increased grasp of the practical application of engineering knowledge. (Aman Yadav, 2007)

To truly improve understanding of real industry problems, a shift in the way they are approached in academia could offer significant opportunity. Rather than the traditional lecture format, flipped learning offers opportunities for more engaging active learning and detailed interaction with the problem statements.

Buffer preparation represents an ideal opportunity being the largest constituent by volume in the manufacturing process. Buffer solutions are separated from the core process and represent a common problem area in the industry in a non-competitive space. Manufacturing companies are becoming increasingly collaborative and willing to publish and share data which only serves to increase the potential for closer relationships with academia. This willingness is demonstrated by the close collaboration of manufacturing companies with organisations such as BioPhorum (BioPhorum, n.d.).

2. Flipped Learning Approach

Tracing origins back to a model of "peer instruction" implemented at Harvard University in the 1990's, the use of flipped learning is increasing in prominence in higher education (Crouch & Mazura, 2001) (Hwang, Yin, & Chu, 2019). Flipped learning involves the delivery of teaching material ahead of time, freeing up the class time for engaging collaborative activities.

The use of flipped learning provides an opportunity to combine various pedagogical philosophies incorporating traditional instructional lectures with an active learning approach (Karabulut-Ilgu, Jaramillo Cherez, & Jahren, 2018). In line with the principal of reduced cognitive load, students are able to work

through the material ahead of the class, which furthers the potential for learning within the class (Seery, 2015).

The use of flipped learning has been demonstrated to increase peer interaction and allow a deeper engagement with the material, facilitating more complex discussions and interactions in the class room setting. This furthers the development of essential professional skills such as critical thinking (Karabulut-Ilgü, Jaramillo Cherrez, & Jahren, 2018) (Seery, 2015).

Interactive design sessions based on the concept of flipped learning may be used to foster a greater level of integration between industrial concepts and applications of sustainability with university engineering courses. While collaboration between industry and academia is increasing in frequency and prominence, opportunities for further development and improvement exist.

External lectures from industry experts are frequently provided to engineering students. These typically follow the traditional lecture format whereby an overview of a topic is provided to the students. While this is engaging for students, the learning format is passive and interaction is relatively minimal. It is difficult for the students to digest the material in real time and actively engage with the subject matter. Given the availability of industry experts, follow up is minimal.

Through the utilization of a flipped learning format, students are provided the opportunity to acquire broad knowledge of the subject matter ahead of time. This allows the classroom exercise to delve into detail on specific topics of interest and practice and apply concepts to real world examples. The increased levels of interaction foster a closer relationship with industry and provide greater levels of understanding into the nuances and challenges of real world examples.

There are three essential stages to a flipped learning session



2.1 *Flipped Learning – pre-class*

The pre-class element of the flipped learning session is critical to the overall success of the activity. This provides the students with a framework and grounding in the subject and acts as a gateway to a rewarding interactive session. The use of video materials rather than written text for the pre-class learning has a positive impact on the readiness of students to actively participate and benefit from the flipped learning session. While written materials may be used, they should be supplemented with a general introduction at least in video format (Lee & Choi, 2019).

Critical success factors associated with pre class activities include the provision of clear and concise teaching material in a timely manner to allow paced learning with well-defined objectives and guidance. In

the case of external lecturers, support should be provided by the academic staff in the preparation and outline of teaching material given the likely lack of teaching experience.

To promote engagement with the subject matter and critical thinking, a pre-class activity or assignment is desirable. Previous publications have demonstrated the importance of pre-class assignments to promote engagement with the subject matter and encourage critical thinking. The use of assignments act as a motivational factor and adds a level of accountability (Han & Klein, 2019).

2.2 *Flipped Learning – in-class*

It is essential the in-class learning builds upon any pre-class learning but should not be a simple replication. Regardless of the quality of pre-class material, there will be gaps in the students' knowledge. There is benefit in starting the in-class session with a brief overview with a view to tackling those knowledge gaps and addressing questions or uncertainties, which students may have.

It is essential that the primary focus of the in-class session is activity or project based. Through the use of real industry case studies, a problem statement should be provided to the students to resolve in a group manner. While the in-class element should allow space to approach the problem from multiple angles, it is important to have an overarching structure to the session in order to maximize the benefit to the students.

2.3 *Flipped Learning – post-class*

The engagement with pre-class material and interaction with in class elements will provide the student with a very good grounding in the subject matter and the potential industry applications. To reinforce the learning, it is essential to have a follow up to the topic which can be assignment/project based. The evaluation of assignment quality with feedback from industry experts will be used as a means of evaluating the efficacy of the teaching format.

3. The role of Buffer Solutions for the Biopharma Industry

Buffer solutions, used throughout downstream processing are critical to the biopharmaceutical industry, impacting on process robustness, product quality and yield as well as accounting for a high proportion of capital and operating expenditure (Gunter Jagschies, 2017) (Haigney, 2016). It has been reported that solution preparation for a biopharmaceutical industry represents over 20% of the facility footprint and overheads for larger manufacturing facilities (Langer & Rader, 2014).

In the drive to reduce the cost and thus improve availability of medicinal products enhancing the social sustainability, there have been considerable improvements to the efficiency of manufacturing processes. A great number of these improvements such as higher titre cell lines have taken place in upstream processing (cell culture) (Jacquemart, et al., 2016). As downstream operations are mass based, improvements to upstream productivity result in a proportional increase in the demand for buffers. This is illustrated in Figure 1, which illustrates the impact of scale, and titre on a typical Monoclonal Antibody manufacturing process (generated using The BioSolve Process software application from Biopharm Services Ltd).

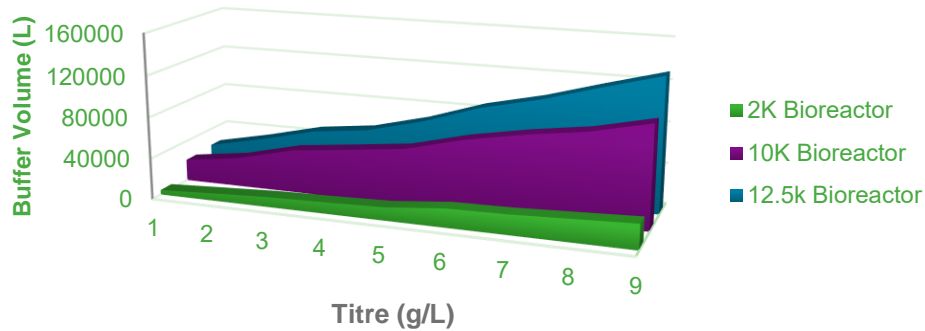

Figure 1: Impact of scale and production capacity on buffer demand per batch

To support the manufacturing process, buffer solutions must be prepared, transferred, stored and delivered to the process. There are typically three buffer preparation philosophies available to manufacturing companies.

- **Traditional Buffer Preparation:** Preparation of multi-component buffer solutions in fixed vessels or single use mixers at the required process concentration, which must be held in an intermediate storage system prior to delivery to the process.
- **Buffer Concentrates:** Preparation of multi-component buffer solutions in fixed vessels or single use mixers at a higher concentration than that required by the process, which must be held in an intermediate storage system and diluted prior to delivery to the process.
- **Inline Conditioning/Buffer Stock Blending:** Preparation of buffers inline from concentrated single component stock solutions at the final required concentration ready for delivery to the process equipment without the need for intermediate storage.

The overall efficiency and consequently sustainability of buffer preparation is significantly impacted by the overall solution management philosophy due to factors including technology selection, operational strategy and logistics and cleaning requirements for equipment.

- **Facility Construction:** Necessary buffer volumes associated with a buffer philosophy impact on overall facility footprint and energy loading to support the building.
- **Equipment:** The decision to use of fixed stainless steel (or higher grade alloy) vessels, single use equipment or inline condition systems has a direct impact on the raw materials required for fabrication, the ongoing utility demand associated with preparation and cleaning and the levels of solid waste generated by a facility.
- **Logistics:** Given the complexity and criticality of the logistics, the design of a buffer preparation area is typically based on design tools such as discrete event simulators or finite capacity scheduling tools. The buffer preparation philosophy and operational strategy have a direct impact on equipment requirements, headcount and hours of operation.

4. Application of Flipped Learning to Buffer Preparation

Buffer preparation offers an ideal opportunity for increased collaboration between industry and academia. The use of a flipped learning session based on real industry problems would increase student's engagement and learning potential while at the same time encouraging an innovative mind-set, which can support process design innovation from the bottom up in the industry.

Industry involvement will be key to success. As preparation for the class exercise, it will be essential to develop concise training material, ideally in video format, which provides a broad overview of biopharmaceutical manufacturing, the criticality of buffer solutions and the various buffer preparation philosophies used by the industry, giving insight into the key sustainability issues. The use of industry experts as participants, the support of academic staff in the preparation and outline of teaching material will be important.

To encourage activate student participation and integrated group engagement; a pre-class assignment is provided. Various student groups will be assigned different areas such as facility design, equipment/technology, material and logistics, requiring them to collaborate and pool their information during the main design session.

The in class exercise will therefore be based on active integrated participation reflecting the way in which commercial design companies operate. While allowing time for an overview of the topic and provision of clarifications, it is critical that the exercise does not become a traditional lecture. The class exercise is to be based on a clear real world problem statement focused on improving the sustainability of buffer preparation through innovation while considering traditional drivers such as capital and operating costs.

5. Conclusion

To improve sustainability in the biopharmaceutical industry, there is a clear need for innovation and change in design thinking. A key factor in driving this change will be an enhanced relationship between academia and industry to drive industry change from the bottom up. Collaboration with industry will allow universities to experience genuine awareness of sustainable development as it applies to real world design issues, accounting for economic and practical design considerations also.

The flipped learning approach is an ideal methodology to develop this closer symbiotic relationship. Through participation based classes, active learning will facilitate critical thinking on real world design problems, resulting in more engaging complex discussions.

There are many opportunities to improve sustainability in the biopharmaceutical industry with buffer preparation being an ideal starting point. As a support function, buffer solutions are the largest constituents by volume in the manufacturing process and are a common feature across the industry regardless of modalities or processing technology. In conclusion, this research brings together a number of critical factors in a hitherto untried format: Industry, Education, Flipped Learning, Applied Design, Optimisation, Real World Metrics with enhanced sustainability as the overarching principle

6. References

- Aman Yadav, M. L. (2007). Teaching Science With Case Studies: A National Survey of Faculty Perceptions of the Benefits and Challenges of Using Cases. *The Journal of College Science Teaching*, 34-38.
- Biogen. (2016). *2030 Outlook on Sustainability in the Biopharma Industry*. Biogen.
- BioPhorum. (n.d.). *BioPhorum*. Retrieved from Buffer Preparation: <https://www.biophorum.com/buffer-preparation/>
- Crouch, C., & Mazura, E. (2001). Peer Instruction: Ten years of experience and results. *American Journal of Physics*, 970-977.

- Gunter Jagschies, E. L. (2017). *Biopharmaceutical Processing: Development, Design, and Implementation of Manufacturing Processes covers bioprocessing from cell line development to bulk drug substances*. Elsevier.
- Haigney, S. (2016). The Importance of Buffers in Downstream Processing. *BioPharm International Volume 29, Issue 4*, 26-29.
- Han, E. P., & Klein, K. C. (2019). Pre-Class Learning Methods for Flipped Classrooms. *American Journal of Pharmaceutical Education Vol 83 Issue 1*, 40-49.
- Hwang, G.-J., Yin, C., & Chu, H.-C. (2019). The era of flipped learning: promoting active learning and higher order thinking with innovative flipped learning strategies and supporting systems . *Interactive Learning Environments*, 991-994.
- Ignacio, J. (2013, 06 13). *From Single-Use to Re-Use: Even plastic used for biopharma manufacturing can be recycled, if we put our minds to it*. Retrieved from The Medicine Maker: <https://themedicinemaker.com/manufacture/from-single-use-to-re-use>
- Jacquemart, R., Vandersluis, M., Zhao, M., Sukhija, K., Sidhu, N., & Stout, J. (2016). A Single-use Strategy to Enable Manufacturing of Affordable Biologics. *Computational and Structural Biotechnology Journal Volume 14*, 309-318.
- Karabulut-Ilgu, A., Jaramillo Cherez, N., & Jahren, C. T. (2018). A systematic review of research on the flipped learning method in engineering education. *British Journal of Educational Technology Vol 49 Issue 3*, 398-411.
- Langer, E., & Rader, R. (2014). Powders and Bulk Liquids: Economics of Culture Media and Buffer Preparation are changing. *BioProcess International*, 10-16.
- Lee, J., & Choi, H. (2019). Rethinking the flipped learning pre-class: Its influence on the success of flipped learning and related factors. *British Journal of Educational Technology Vol 50*, 934-945.
- Martin, J. (2016). Improving Sustainability in Pharmaceutical Manufacturing. *Pharmaceutical Processing*.
- Mensah, J., & Casadevall, S. (2019). Sustainable development: Meaning, history , principles, pillars, and implications for human action: Literature Review. *Cogent Social Sciences Volume 5*.
- Paul Kowal, S. C.-M. (2012). Data Resource Profile: The World Health Organization Study on global AGEing and adult health (SAGE). *International Journal of Epidemiology, Volume 41, Issue 6*, 1639–1649.
- Pizzi, V., Flanagan, W., Pietrzykowski, M., & Brown, A. (2014). An Environmental Lifecycle Assessment of Single-Use and Conventional Process Technology: Comprehensive Environmental Impacts. *BioPharm International Volume 27, Issue 3*.
- Rader, R. A., & Langer, E. S. (2018). Worldwide Biopharmaceutical Manufacturing Capacity Analysis: Growth Continues Across the Board. *Bioprocess International*.
- Rawlings, B., & Pora, H. (2009). Environmental Impact of Single-Use and Reusable Bioprocess Systems. *Bioprocess International*, 18-26.
- Seery, M. K. (2015). Flipped learning in higher education chemistry:emerging trends and potential directions. *Chemistry Education Research and Practice Issue 4*, 758-768.
- Sinclair, A., Leveen, L., Monge, M., Lim, J., & Cox, S. (2008). The environmental impact of disposable technologies. *Biopharm International*, 4-15.
- WCED. (1987). *Report of the World Commission on Environment and Development: Our Common Future*. Oxford: Oxford University Press.
- Wise, J., Möller, A., Christie, D., Kalra, D., Brodsky, E., Georgieva, E., . . . Arlington, S. (April 2018). The positive impacts of Real-World Data on the challenges facing the evolution of biopharma. *Drug Discovery Today Volume 23, Issue 4*, 788-801.

EESD2020 Submission 12: Art into Engineering: Demonstrating how Origami creativity can inform Robotics education

Guangbo Hao¹, Alex Pentek²

¹School of Engineering, University College Cork (UCC), Republic of Ireland

Corresponding author: G.Hao@ucc.ie

²National Sculpture Factory, Albert Road, Cork City, Republic of Ireland

Abstract

This paper discusses a teaching method in promoting students' learning and creativity in Robotics, which uses active Origami as a lab-based (design) tool to analyse and design robots. The Origami-led course design involves a lecturer team composed of an Origami artist and a Mechanical Engineer. It includes three parts: Part I is the introduction and theory of Origami as well as engineering application and the kinematic mapping between Robotics and Origami; Part II is the intensive hands-on training of Origami folding; and Part III is an Origami-based project as continuous assessment in the Advanced Robotics module. Learners/trainees have voted great compliments on the Origami-led course design. It shows that Origami is an effective tool and media to teach Robotics, and is suitable for teaching other Engineering topics such as structure and civil engineering.

1 Introduction

Robotics has become one of the hottest topics in research and industry, especially in the context of artificial intelligence and industry 4.0, which requires university for responsible education. Teaching robotics (such as ME6012-Advanced Robotics in UCC) contributes to the core-learning outcome of Mechanical Engineering degree. Robots typically consist of rigid links connected by kinematic joints such as revolute joints (hinges) and prismatic joints. There are two main tasks in robotics: Analysis and Design, which both require solid knowledge in mathematics and mechanics. An efficient way to help students master robotics knowledge is through a lab-based design project, where students can observe a physical motion on a robot prototype, and play with and analyze the motion toward designing a new robot for purposeful application. However, there is a great challenge in running the lab-based design project in an engineering class due to the limitation in learning space and cost even without mentioning health and safety issues.

Origami, as an ancient Japanese and/or Chinese art, is currently widely used for creating sculpture by artists (such as Pentek, 2020) and designing foldable structures/robots by engineers (Nishiyama, 2012; Zhakypov *et al.*, 2018). Origami was also used for teaching geometry, thinking skills, fractions, problem solving, and fun science. Origami can be easily implemented by handcrafting creases from a piece of paper, which promotes creativity for teaching and research purpose. If we substitute the paper facets and creases (foldlines) with rigid links and revolute (R) joints, we can equate Origami and Robot. Using Origami we can enable a robotic analysis intuitively and inspire a new robot design. This is an efficient way to help students master robotics knowledge without the implementation issue in space and cost, which can also greatly inspire students' interest in a new learning space.

In order to demonstrate the equivalent relation between Origami and Robots, we use an Origami reverse fold as an example as shown in Fig. 1. The reverse fold is one of the basic folds in Origami, where three valley creases and one mountain crease intersect at one vertex. This is actually a spherical robot with four R joints locating at the four foldlines. The kinematic constraint equation can be obtained as below based on the spatial vector loop (Fig. 1):

$$\mathbf{L}_1 + \mathbf{L}_2 + \mathbf{L}_3 = \mathbf{L}_0 \quad (1)$$

where all vectors are with respect to the fixed frame system. Solving equation (1) requires the use of coordinate transformations and variable definitions, which are out of scope of this paper.

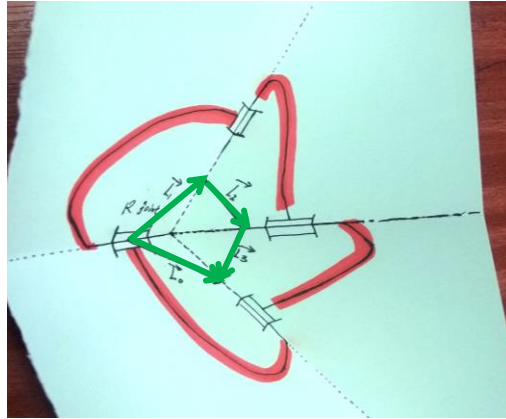

Figure 1: Reverse fold with kinematic mapping

With the similar motivation in combining Art and Robots (Herath and Kroos, 2016), this paper discusses the use of Origami in teaching robotics. Section 2 presented the Origami-led course design in detail, followed by feedbacks from trainees in Sec. 3 and reflections in Sec. 4. Conclusions are finally drawn in Sec. 5.

2 Origami-Led Course Design

The Origami-led course is delivered by a team, which consists of an Origami artist (second author of this paper) and a Mechanical Engineer (first author of this paper). It includes three parts. Part I is a 2-hour lecture mainly on the introduction and theory of Origami (by the artist) as well as engineering applications and the kinematic mapping between Robotics and Origami (by the engineer) (Fig. 2). This lecture was held in a traditional lecture room in UCC, ending with a warm-up of simple folding. Part II is a two-session intensive hands-on workshop of Origami (Fig. 3), which was delivered by the artist. Both sessions were held in National Sculpture Factory (NSF) in Cork, with each session lasting 2.5 hours. The first session workshop is on the individual training on several basic Origami folds such as Miura fold and Waterbomb fold. The folds were implemented on 90g A4 papers. After the first-session hands-on training, students were able to repeat the basic folds. In the second session workshop for Part II, students were split into teams working on folding big-size papers (Fig. 4). All teams starting from the same foundation folds aimed to create different Origami designs in the end. Each team was required to use at least two different folds in their final finish using their creativity with innovation in consideration. The prototypes completed by each team are shown in Fig. 4(a), (b) and (c) and all prototypes connected together is shown in Fig. 4(d).

Part III is an individual Origami-based project as continuous assessment (CA) in the Advanced Robotics module. The CA work's requirements are shown as below, based on which the outputs of one student can be indicated in Figs. 5 and 6.

- Conducting a literature review on the “Design of Robots inspired by Origami”.
- Repeating an existing robot design (or creating a new design) using Origami technologies.
- Analysing kinematics of the design.
- A 5000-word (or equivalent including figures) report is required for submission to Canvas.
- CA is composed of writing a report (20 marks) and giving an oral presentation (10 marks). The oral presentation taking 15 minutes of each student is the concise explanation of the written report. Students are also required to bring a printed poster and an Origami piece for engaging with public audiences/peers.



Figure 2: Course Part I

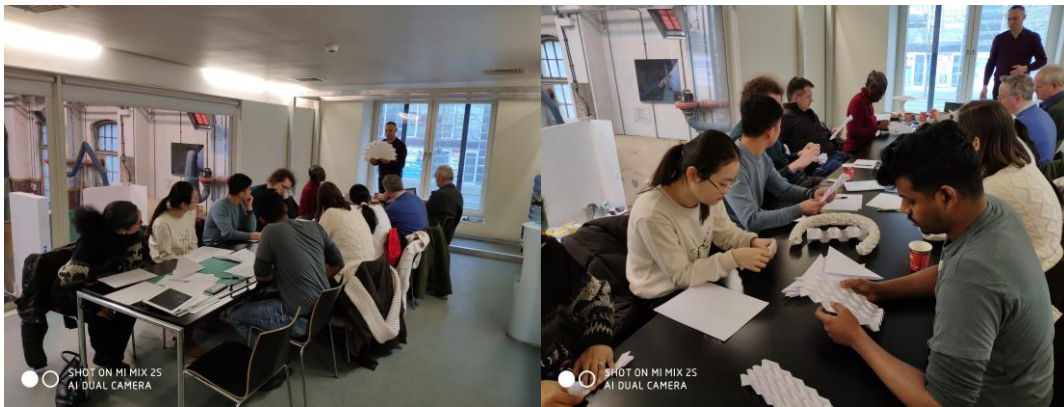

Figure 3: Course Part II 1st session (L: folding demonstration; R: students working on Miura folding)

3 Feedbacks from Trainees

There are 11 trainees attending the first-session hands-on workshop, including 4 UCC academic staffs (two from Architecture, one from Business Information Systems and one from Digital Humanities), 4 PhD students and 3 master students. 82% trainees voted “excellent” for the overall quality of the Origami course and 18% voted “very good” (Fig. 7).

The positive and encouraging comments written on evaluation forms from trainees are summarized below.

- ❖ Question: Does the Origami workshop help your understanding of Robotics Knowledge? If so, why?
“Yes, different types of folds and knots represent different joints. It is handy to have Origami to build a rough prototype out of paper”; “Yes, was a new way to see robots and could inspire the design of new kinds of robots”; “Not directly but I can see the relation”; “Yes, Origami also contains a lot of joints, that is the similarity with traditional mechanical design”; “Yes, bringing one simple revolute joint to complex shapes is very insightful”; “Yes, this certain part of robotics, specifically to have unique solution via intelligent mechanics instead of programming and for unique atoric”
- ❖ Question: Does the Origami inspire design of new robots? How?
“It is interesting to see how all the different pack of paper behave as we are working on one fold (joint)”; “Origami could be a good inspiration for new robots”; “I think it can do that but it will take time to become familiar with how it works”; “Very relevant to deployment and packing of dynamic, flexible and transportable structures”; “Yes, Robots are not limited to certain kinds of forms. All Origami structures can be utilised in certain way as robots”; “Yes, free shapes is very inspiring”; “I can imagine its use in creating emergency shelters”; “Yes, by enabling unique actoric”
- ❖ Question: How do you comment on the new Learning Space comparing to the traditional one?
“Interesting and Promising. New approach equips me with a skill of transform ideas into paper whenever I want”; “The learning space is more practical and in this way it is possible to experiment personally what I want”; “Excellent”; “Practical work is very useful and encouraged in my own teaching”; “I love the new learning place. It makes more excited on new knowledge”; “Yes, it opens up more creative thought”; “Workshop gives a better understanding especially when it is hands-on and to see a finished product-good entertainment.” “Very nice space”; “The sculpture facility is amazing learning space for creative hands on work.”
- ❖ Question: Any other comments for the lecturer/content?
“Excellent way of teaching”; “Really appreciate the enthusiasm and the patience”; “Content was perfect”; “Hope this content can be opened to architecture and engineering students as well”; “Very interesting with lots of possible applications”



(a) Team I design prototype

(b) Team II design prototype

(c) Team III design prototype



(d) All designs connected together

Figure 4: Course Part II 2nd session

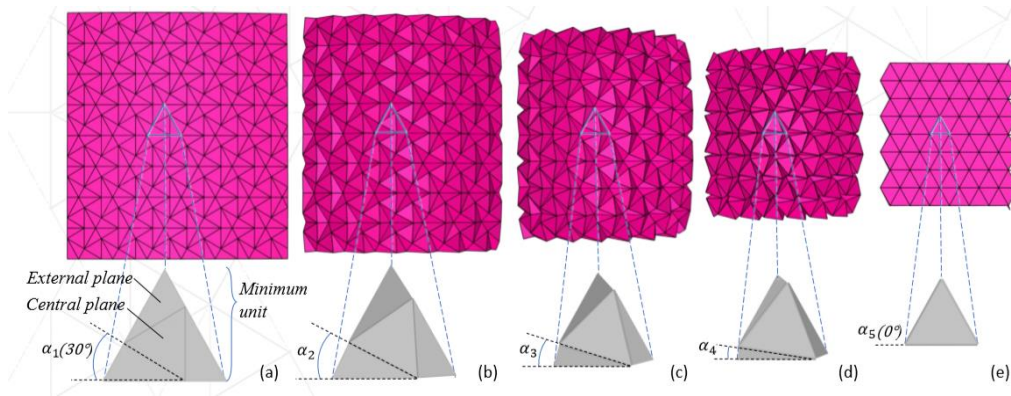

Figure 5: Course Part III: inspiration by the Resch Triangular Tessellation

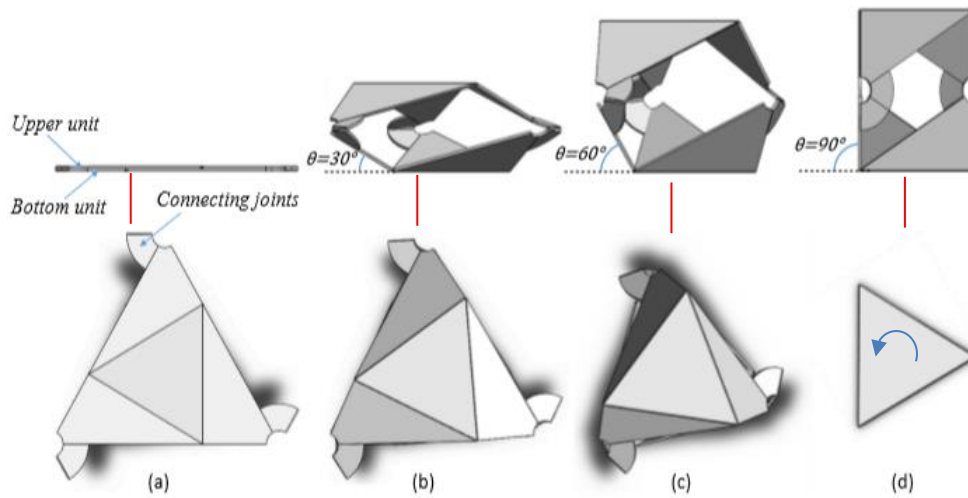

Figure 6: Course Part III: design of a twisting robot by connecting two Origami units

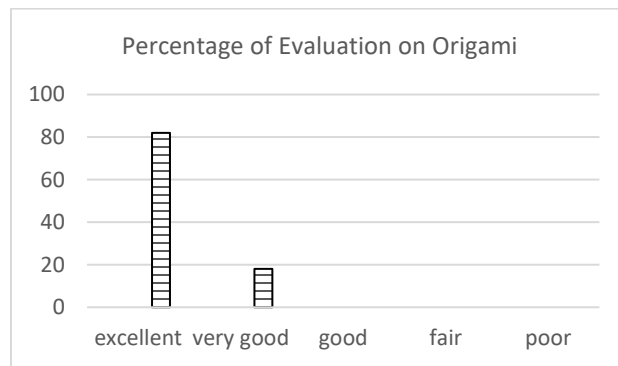

Figure 7: Evaluation from trainees

After completing the second-session hands-on workshop, further comments received from several trainees by email as follows:

➤ “But I wanted to thank you for organising such an imaginative, original and very effective workshop. I learned a lot and thoroughly enjoyed it. My research area at the moment is on interdisciplinary,

in particular arts and STEM collaborations (as you can see from the publication on my signature below) and I would like to keep on this list if possible please, and to continue attending other events on the subject that you may have.”

➤ *“Thank you making effort to introduce me into Origami. It was insightful and informative to see how something as simple as a paper transform into something that has interesting abilities. I am looking forward to explore more into Origami and how the techniques are used in robotics and mechanical engineering.”*

➤ *“Thanks for organizing this inspiring and interesting workshop. I have learned lots of Origami techniques as well as stimulated my imagination from it. What's more, it's closely linked to my project, and I can not wait to apply the Origami in it. At last, thanks for Alex patiently teaching, hope I will have chances to get involve in this kind of workshop.”*

➤ *“The Origami Workshop was interesting, and it has given me an overview of what can be built with Origami. There were also practical experiences in folding papers, and that experiences increased the student involvement and understanding. At the beginning was a bit challenging understanding how the folds have to be done, but at the end the result was impressive. In the last lesson, we were split in groups to figure out our Origami structure and solicited to be creative. It was a good way to work together and share ideas. Before taking this workshop, I thought that Origami is only about paper folding aimed to create something to play. I had never thought about the relationship between Origami and robotics application. This workshop showed me Origami from a new and very interesting prospective.”*

➤ *“Many thanks for organizing the Origami workshops, which we found very interesting, and the final exercise working at larger scale in mixed teams very stimulating. We often refer to Origami in our teaching of both architecture and engineering students, and feel there is an untapped potential interest for such workshops to be offered to students in both schools.”*

➤ *“It was a unique experience to have some hands on training with Origami folding patterns. While I find the folding of specific (animal) shapes, as it is most often taught in books, has little applications to engineering, I found it very fascinating to do some easy folds, that patterned over a sheet of paper, would greatly modify the mechanical properties of this paper. Therefore I found this course a much better introduction into Origami methods for engineers than most books about Origami I read in the past. Unfortunately I wasn't at the first lecture and can't say much about this. But one question that remained in my head was how different Origami pattern change the material properties and cause flexibility or stiffness in certain directions as well as create compliant mechanism in the structure. I would be happy to have an overview of some of the most used Origami patterns and their respective effects. On top of that I found the workshop well organized and where fascinated by the National Sculpture Factory, which I only have ever seen from the outside”*

From the above feedbacks, we can learn that students have greatly appreciated the Origami course that has changed their way in thinking about Origami and Robotic as well as stimulating new robot designs. Students also commended the new learning space using Origami in the National Sculpture Factory for robotics education.

4 Reflections

A direct experience led approach forms the basis of this module where the behaviour of complex rigid Origami surfaces cannot easily be predicted in Part I. By introducing a number of rigid Origami crease patterns in Part II these can then be practically applied by the students to a broad range of design applications, allowing them to explore their new ideas independently and intuitively in Part III.

- **Reflection on Creativity in Design.** Engineering design classically begins at the drawing phase to be then refined and practically informed by the creation of a 3D working model. The time and related costs

of this linear process means that it can be greatly limited by the availability of resources: By comparison, this program shows that origami can provide a new exciting, inexpensive and quick method to simultaneously sketch and make working articulated models from paper. This is an attribute associated with sustainability in engineering education. From a creative perspective it allows an effective materials-led design process of discovery for the student. While the discipline of origami uses humble materials such as paper, it is by no means simplistic. The mathematically proven axioms and geometry within origami provide an infinitely complex platform to stimulate students' creative thinking and problem solving on multiple levels, while simultaneously recording students' individual progress within the module.

This has already yielded successful results in the individual origami-based robotic project (Part III), where new origami inspired robots were created (Fig. 6). Used as an educational tool, origami promotes individual creative thinking but it also successfully allows groups of students to think creatively as a team (Part II). By working on a large scale students had to work together and collectively draw on their experience of origami patterns to creatively solve new technical challenges. These teams then finally collaborated to create a single deployable structure from their unique fold designs (Fig. 3d). This demonstrates origami as a medium that allows students to practice communication skills within groups and also between groups to be part of a larger and more complex creative design team.

- ***Reflection on Playfulness and Innovation in Design.*** Innovation is the key to successful design and educational strategy. Two ways in which innovation can occur are through playfulness and by mixing different areas of knowledge and expertise. It has been our aim to nurture a comfortable, playful and inspiring environment by moving out of the traditional Robotics Engineering learning space that can sometimes be overwhelming for the students into the fresh creative surroundings of the NSF. We have chosen to introduce the discipline of origami to robotic education as it brings playfulness into the design process and mixes both of these disciplines. If this playfulness is combined with a specific real world task in the work space (such as grasping, lifting or moving), it may allow the physical properties of the paper material to interact with the environment of the workspace. This level of interaction could in some cases allow greater parity between the design task and the workspace environment, leading to increased successful robotic design by a passive dynamic approach (Collins, 2005).

- ***Reflection on the Value of Art in Engineering Programmes.*** Origami is a recognized art form whose geometry and economy of line contain a certain aesthetic. By introducing students to these aesthetics and techniques it allows them to make exciting discoveries and create new complex articulated forms of their own. This helps to inform and inspire the design process in successful advanced robotic engineering design. The most economic and successful solution is also often more elegant and visually pleasing. Evidence of this can easily be found in the natural world and in bio mimetic design. In addition to eliciting an intuitive and almost eidetic way of thinking through imagery, the subject of art also brings much more to an engineering program that will often focus on a series of very specific tasks. Since time immemorial the word 'art' has long been associated with skill. Because of this association, in its broadest definition the art of a subject can also mean the total skill or gestalt of that subject (Read, 1948). In a safe workspace that allows materials led design to occur, this holistic ethos encourages a dynamic approach to the art of robotic engineering design/education; encompassing the entire program while remaining open to inspiration from outside fields of knowledge and expertise. For the above reasons, art is an invaluable resource in this engineering program.

- **Reflection on Other Considerations.** (i) A competent and experienced lecturer/tutor team is important to make the practical origami aspect of this program successful (Part I & Part II). As this course combines the communication of in depth knowledge from an origami artist and an engineer in robotics, a mutual understanding between these areas of expertise is essential. This cross disciplinary approach has allowed the maximum learning outcome for students. (ii) If this educational model is adapted for other engineering topics such as structure/ architecture, a theoretical mapping of the relation between origami and the engineering topic as the key should be designed appropriately in advance. (iii) The current Origami course is embedded into a 5- credit robotics module. In order to make an impact and spread this teaching method to a broad community, a full 5-credit Origami course would need to be established. (iv) In order to ensure that the tutor can provide essential close guidance to each individual there is a limit to the number of trainees for the practical workshop. In our Origami workshop, we set the maximum number to be 12 to match a 2-person tutor team.

5 Conclusions

By introducing Origami into Robotics education, we have demonstrated that Origami is an effective tool and media to teach Robotics and that Origami can be adapted to teach other Engineering topics such as structure and civil engineering. Origami is a sustainable media in promoting creation towards innovation. In the near future, we will show the final design products from students' CA projects.

Acknowledgement

This project is funded by National Forum Strategic Alignment of Teaching and Learning Enhancement Funding in Higher Education 2019, through the UCC Office of the Vice-President for Learning and Teaching. Ms. Valerie Byrne, Head of National Sculpture Factory, is greatly appreciated for facilitating the use of their facility in running the hands-on workshop. The authors would also like to express their gratitude to the student, Haitong Liang, who completed the project III works as shown in Figs. 5 and 6.

References

- Herath, D. and Kroos, C. eds., 2016. Robots and art: Exploring an unlikely symbiosis. Springer.
- Nishiyama, Y., 2012. Miura folding: Applying Origami to space exploration. *International Journal of Pure and Applied Mathematics*, 79(2), pp.269-279.
- Pentek, Alex. 2020. Website: <http://alexpentek.com/>
- Zhakypov, Z., Heremans, F., Billard, A. and Paik, J., 2018. An Origami-inspired reconfigurable suction gripper for picking objects with variable shape and size. *IEEE Robotics and Automation Letters*, 3(4), pp.2894-2901.
- Collins, S., Ruina, A., Tedrake, R. and Wisse, M., 2005. Efficient bipedal robots based on passive-dynamic walkers. *Science*, 307(5712), pp.1082-1085.
- Read, H., 1948. Education through art. London, Faber and Faber.

Global Perspectives on Electric Vehicle Education: Part I

John G. Hayes¹, Yue Cao², Xinmei Yuan³, Jessica L. Suda⁴, Xiaofeng Yang⁵, Jens Friebe⁶, Osmar Ogashawara⁷, John P. Renie⁸, and G.A. Goodarzi⁹

¹School of Engineering, University College Cork, Ireland

john.hayes@ucc.ie

²Energy Systems Group, School of EECS, Oregon State University, USA

³College of Automotive Engineering, Jilin University, China

⁴Transportation Education Ctr., Department of Automotive Tech., Southern Illinois University, USA

⁵School of Electrical Engineering, Beijing Jiaotong University, China

⁶Electrical Engineering and Computer Science, Leibniz University Hannover, Germany

⁷Centro de Ciências Exatas e de Tecnologia, Universidade Federal de Sao Carlos, Sao Paulo, Brazil

⁸Mechanical Engineering, Indiana Institute of Technology, USA

⁹US Hybrid Corp., Torrance, California, USA

Abstract

In this two-paper set, academics from universities in the Americas, China and Europe discuss educational and pedagogical developments at university level on electric vehicles (EV). EVs, whether battery (BEV), hybrid (HEV) or fuel cell (FCEV), are seen as being a crucial and essential component of sustainable living, and entire industries around the world are evolving to foster the development of electromobility. Thus, university curricula must also adapt. The authors, university by university, investigate the motivations, challenges and adaptations for EV education and the related pedagogy. Aspects of the related curricula are discussed with helpful insights on content and adoption. Challenges and future adaptations are often discussed. Academics from the following universities contribute to the papers, which are presented in two parts in order to cover the topic. Part I: University College Cork (UCC) and US Hybrid (USH), Indiana Institute of Technology (IT), Beijing Jiaotong University (BJTU), and Southern Illinois University Carbondale (SIUC); Part II: Jilin University (JLU), Oregon State University (OSU), Leibniz University Hannover (LUH), and Universidade Federal de Sao Carlos (UFCar).

See Part II for the conclusion to this two-paper set [1].

1 Introduction

The automotive industry is currently undergoing a significant transformation as it embraces electric vehicles (EVs). Societal interest in EVs, and related EV sales, have both grown significantly over the past decade. The interest is spurred by a number of significant factors, such as the reduction of carbon emissions to mitigate climate change, the reduction of toxic tailpipe emissions in urban environments, the increased use of renewable energy with a correlated reduction in the use of fossil fuels for energy security, and the development of green industries.

This technological evolution has significant implications for educationalists globally. Academics at universities are challenged with evolving or transforming university curricula in order to provide appropriate teaching, with the impacts of electromobility being felt across a wide range of disciplines.

The objective of this pair of papers at the *Engineering Education for Sustainable Development 2020* conference is to provide insights for practicing teachers into educational and pedagogical developments

around the world into the teaching of electromobility. While EVs are the main interest of the collaborating academics, the topics of electric aircraft and rail are also discussed as both these transportation fields also heavily embrace electrification.

PART I: J.G. Hayes (UCC) and **G.A. Goodarzi** (CEO/President of USH) have developed a widely-adopted university textbook and related curriculum on EVs. The structure of a teaching stream is presented, beginning with the environmental motivations for EVs and continuing into the core foundational areas of battery, hybrid and fuel cell EV power trains, electromagnetism, traction machines, and power electronics. **J.P. Renie** (IT) has adopted the Hayes-Goodarzi textbook and modified the existing coursework in Indiana Tech's energy engineering program dealing with batteries, fuel cells and energy storage to incorporate current electric drivetrain analyses. See Part II for the conclusions.

X. Yuan (JLU) explains that the EV has been broadly integrated into the teaching across all areas of automotive technologies at JLU. He discusses the studies on the evaluation of the energy, environmental, and economic impacts of electric vehicles, and the corresponding attempts in classes to help conventional automotive engineering students better understand electric vehicles from a macro perspective. **J. Suda** (SIUC) explains that EV studies greatly impact other broad areas of the automobile, such as braking systems and temperature-control systems. She discusses the necessary evolution of the automotive technology curricula at the secondary and post-secondary educational levels to accommodate the automotive industry's critical need for a workforce knowledgeable in EV technology during this pivotal time in automotive history.

PART II: Y. Cao (OSU), who works at the heart of the U.S. aerospace industry, has introduced special topics on the more-electric aircraft (MEA) and the unmanned aerial vehicle (UAV) as an extension of the EV curriculum. **X. Yang** (BJTU) discusses the role and development of rail transit for sustainable urban transport based on industrial and academic experiences. **O. Ogashawara** (UFCar) discusses the development of a course using Active Learning Methodologies to teach BEVs and HEVs. The discipline goals are the design, modeling and simulation of a vehicle for the Formula SAE Electric Competition. The course uses Team-Based Learning, Flipped Classroom, Project-Based Learning and Fishbowl methods. **Dr. Friebe** (LUH) discusses developments at Leibniz University Hannover.

2 Development of an EV textbook and curriculum at University College Cork (J.G. Hayes & G.A. Goodarzi)

2.1 Background

Prior to joining UCC as a power electronics academic in 2000, J.G. Hayes spent the decade of the 1990s working in Los Angeles developing the power electronics and drives for the General Motors EV1, the first production EV of the modern era. Whilst at UCC, he has continued to be involved with automotive research and regularly includes EVs as part of the curriculum. In 2014, Hayes and former General Motors EV1 colleague Abas Goodarzi, now CEO and President of US Hybrid, began writing a university-level textbook on EVs. At the time, it was becoming clear that battery technology had improved significantly and that the governmental and public attitudes to green technologies has shifted enormously from the 1990s. It was also clear that educational resources, such as teaching textbooks, were essential to the coming electrification of society.

2.2 Textbook and Curriculum

The resulting text is primarily an engineering textbook that covers the automotive powertrain, energy storage and energy conversion, power electronics and electrical machines [2]. A significant additional focus is placed on the engineering design, the energy for transportation, and the related environmental impacts. The book contains 16 chapters covering vehicle design considerations, energy sources, electrical machines, power electronics and the basics, as shown in Table I. The material is taught across four years at UCC. An introductory submodule on energy introduces the student to electromobility, sustainability, and the environmental impacts of transportation, such that the freshman student can quantify the related energy densities, carbon emissions, and ranges for different vehicles. The basics of electromagnetism, ferromagnetism, and electromechanical energy conversion (Chapter 16), and dc machines (Chapter 7) are taught to 2nd year (sophomore) engineering students, who have completed introductory electrical circuits and physics. Two related modules are taught to 3rd years, and these build on the students' knowledge of ac circuits and control theory. The first module is taught as a general science module covering vehicular systems (Chapter 2), batteries (Chapter 3), the internal combustion engine and hybridization (Chapter 5), control (Chapter 15), and the permanent-magnet ac machine (Chapter 9). A software project is assigned to model vehicle acceleration using Matlab and Simulink. The second module is more electrical in nature, utilizes hardware laboratories and introduces power electronics, with the non-isolated dc-dc operating in continuous-mode operation (Chapter 11) and the isolated forward (Chapter 12), and ac machines with the induction machine (Chapter 8). The interior-permanent-magnet machine (Chapter 10), power semiconductors (Chapter 11), isolated power converters (Chapter 12), traction inverters (Chapter 13), and power-factor-corrected battery chargers (Chapter 14) can all be covered in final year or at introductory post-graduate level.

Table I: Book content and related teaching at UCC

Chapter	Topic	1st	2nd	3rd	4 th /PG
1	Electromobility and the Environment	Y			
2	Vehicle & Vehicle Dynamics	Y		Y	
3	Energy Batteries	Y		Y	
4	Sources Fuel Cells				Y
5	Conventional & Hybrid Powertrains	Y		Y	Y
6	Introduction to Traction Machines			Y	
7	Electrical The Brushed Dc Machine		Y		
8	Machines Induction Machines				Y
9	Surface-permanent-magnet Ac Machines			Y	
10	Interior-permanent-magnet Ac Machines				Y
11	Dc-dc Converters				Y
12	Power Isolated Dc-dc Converters				Y
13	Electronics Traction Drives and Three-phase Inverters				Y
14	Battery Charging				Y
15	Control of the Electric Drive			Y	
16	Basics Electromagnetism, Ferromagnetism, and Electromechanical Energy Conversion		Y		

2.3 Conclusions and Key Learnings:

- Environmental impacts and the sustainability of technology and society can easily be integrated and investigated using the topic of EVs.

- EVs made the related technical topics of energy storage, power electronics, and machines more engaging for both the instructor and the students.
- Multiple modules are required in order to cover the topic.
- A mix of vehicles, energy storage, power electronics, control, and machines throughout each module helps to maintain a holistic and integrated module and maintain interest.
- Software, hardware and research assignments are easily be integrated into the stream.
- The topic is very dynamic and continuous updating of material enhances the teaching.

3 Utilization of EV textbook within curriculum at Indiana Tech (J.P. Renie)

3.1 Background

For the past decade, the J.P. Renie has been instrumental in teaching courses in a new Energy Engineering (ENE) degree program. This program was initially non-ABET accredited, technical in nature, and complementing other ABET accredited traditional programs in Mechanical, Electrical, and Biomedical Engineering offered at Indiana Tech. Multiple courses, covering such energy related topics of wind and solar, ethanol and biofuels, sustainability, thermodynamics, fluids, heat transfer, and HVAC, were developed and taught to a small group of students interested in this newest subset of engineering education. In addition to these topics, a course involving batteries and fuel cells was offered by industry-based adjunct staff. With the publishing of [2], a decision was made to adopt this textbook and to include electric drivetrain dynamics, in addition to an up-to-date study of batteries and fuel cells to best train the students entering this expanding field of technology.

3.2 Course Material

The course began by focusing on the background information for Electromobility and the Environment covered in Chapter 1 [2]. Particular interest was focused on the EPA drive cycle descriptions and the definitions of various parameters dealing with fuel consumption, range and mile per gallon equivalent (mpge). This section concluded with an overview of conventional, battery, hybrid, and fuel cell electric systems, (Section 1.7). This familiarized the student with the characteristics of the various drivetrain architectures as well as introducing the concept of efficiencies throughout the drivetrain leading to an overall well-to-wheel efficiency with a highlight on CO₂ emissions.

With the general physics prerequisite background of the students, the focus is next on vehicle dynamics (Chapter 2). After describing how the vehicle characteristics, such as mass and road load data, for various vehicles can be obtained from the available EPA files, the students were tasked with determining the acceleration profile for vehicles based on the MATLAB and Excel approaches described in the text. The students were able to utilize these computational skills for their final project/presentation for the class.

Since earlier offerings of this course focused primarily on batteries, fuels cells and other energy storage techniques, the next part of the class focused on Chapter 3 (batteries) and Chapter 4 (fuel cells). The work focused on the battery charge/discharge characteristics related to the battery types associated with the electric drivetrain. During the discussion of these chapters, coordination with the chemistry department permitted a basic electrochemistry experiment, wherein several galvanic cells were constructed and voltages measured and compared to standard oxidation/reduction tables. A Hampden hydrogen fuel cell trainer and a corresponding hydrogen fuel cell characteristic experiment were used to highlight the material

presented in Chapter 4. In both chapters, the focus on the case study examples of economy of BEV and fuel cell electric vehicles (FCEV) was instructive.

The second half of the class began with a strong focus on the material in Chapter 5, Conventional and Hybrid Powertrains. The class had only limited thermodynamic cycle analyses background and so time was spent discussing the background surrounding the torque/efficiency versus engine speed characteristics as well as brake specific fuel consumption maps for various engine types. This was ultimately tied into the analysis of hybrid-electric (HEV) systems, including series and series-parallel operation. The section on the continuously-variable transmission (CVT) converged with the background of the students enrolled in the course, which precluded any gear dynamic analyses that a traditional mechanical engineering student would possess.

To complete the course, focus was given to Chapter 6, Introduction to Traction Machines, and Chapter 7, Brushed DC Machines. Again, due to the technical background of the students, different types of electric motors in addition to machine specifications such as rated conditions as well as the characteristic curves of a traction machine were introduced. This was then followed by the analysis of the DC machine in Chapter 7, again driven by the students' minimal understanding of AC electric fundamentals. The concepts of permanent-magnet (PM) and field-weakening (WF) motor characteristics, including saturation and maximum speed operation, was highlighted. The case study of the Mars Rover Traction machine completed the in-class discussion for the class.

During the course of the semester, the students were tasked with completing many of the textbook problems provided in Chapters 1 through 7. Additionally, five in-class, 50-minute quizzes were given. As a final project presentation, the students were tasked with selecting a unique BEV from a recently modified list given in Assignment 2.1. Taking the lead from the assignment in Chapter 2 of Modelling a BEV, the students were expected to research their vehicle and perform acceleration analyses as well as drive cycle analysis based on both the EPA Highway and UC06 Supplemental. Such an analysis permitted a calculation of battery capacity range as well as CO₂ emissions based on the local electricity-fuel breakdown.

4 Electric vehicle studies and education practices at Jilin University (X. Yuan)

4.1 Background

The automotive engineering discipline of Jilin University was established in 1955 with the establishment of First Automotive Works (FAW) Group Co., Ltd. in China, which plays a very important role as a base for training talented persons for the automotive industry in China. With more than 60 years of development, a complete automotive engineering education system has been set up. However, the trends of electrification of vehicles pose significant challenges to the existing automotive engineering education system. Since the education system needs to be gradually improved, most of the courses are still based on conventional vehicles. Instead of introducing a large number of new specialized courses for EVs, a general understanding of EVs is integrated into the existing courses to address the connections and differences between EVs and conventional fossil-fuel vehicles. This is preferred for most of the students to adapt to the current diversified development of the automotive industry.

4.2 Studies on the evaluation of EVs

The comparison of EVs and conventional vehicles is always controversial, but is necessary for the multidisciplinary understanding of the automotive industry. Therefore, studies on the evaluation of EVs

have been carried out. Generally, the energy and environmental impact of EVs are of greatest concern. Therefore, an analysis shows the relation between EV driving range, energy consumption, and equivalent CO₂ emission is provided in [3]. In this study, combined with the vehicle longitudinal dynamics, life cycle analysis (LCA) is used to address the relationship between vehicle design, vehicle performance and energy, and environmental impacts. In order to better understand the energy consumption characteristics of EVs, using the real-driving emission (RDE) concept for conventional vehicles, a method to evaluate the real-driving energy consumption of electric vehicles has been proposed in [4], where the energy consumption characteristics of EVs and conventional vehicles are compared, and the reason for the significant increase in the energy consumption of EVs on the highway is pointed out. Additionally, economic and policy factors are also very important for the development of the EV industry at the current stage. Accordingly, the impact of the subsidies and non-economic EV promotion policies are modelled and evaluated in [5]. By using the concept of the life-cycle cost, the results show that such non-economic EV promotion policies have a significant impact on improving the competitiveness of EVs, and are more suitable for long-term implementation compared with subsidies.

4.3 Practices in class

A comprehensive EV education system requires a large number of new specialized courses, including electric machines, power electronics, batteries, etc. Adding these courses greatly increases the burden on students. Therefore, one first step tried at JLU has been to add general concepts of EVs to the existing courses. For example, in the control courses, it can be shown that the concepts of the torque and speed control are the same whether the inner loop is an internal combustion engine (ICE) or an electric motor, and the only difference between the ICE and electric motor is the time constant of the torque response. Another example is that when introducing the modelling of a vehicle, just comparing the differences between the universal characteristics of an ICE and the efficiency map of an electric motor, gives an important understanding of EVs, including the fuel/energy consumption estimation, braking regeneration, energy effective operating area, etc. There is even more room for innovation in introductory courses. One example used by Yuan is for a debate contest to be introduced into the course. Students in the class are arranged in groups, and topics related to EVs are given to the debate. It shows that this practice has achieved good results. Students are more proactive in learning relevant knowledge and thinking about the EV industry when preparing for the debate. Some debate topics are listed in Table I.

4.4 Conclusions and Key Learning:

- Due to the rapid deployment and multidisciplinary nature of the automotive industry, the integration of emerging technologies in automotive engineering education systems is challenging.
- Instead of introducing new specialized courses for EVs, general concepts of EVs can be integrated into existing courses in the current education system.
- Facing the current diversified development of the automotive industry, innovation of education is of great value for the students to quickly receive the explosively growing knowledge and to widely adapt to the industry requirements.

Table I: Debate topics in EV class at JLU

No.	Topics		Hints
1	The cost of EV is high compared with conventional vehicles	P	Battery cost and battery aging
	The cost of EV is not high compared with conventional vehicles	N	Maintenance and energy consumption cost Subsidy and intangible cost from promotion policies
2	The technical factors are the primary major barrier preventing the adoption of EVs	P	Driving range and charging rate
	The non-technical factors are the primary major barrier preventing the adoption of EVs	N	Range anxiety, immature market
3	Conventional vehicles are safer than EVs	P	Safety issues caused by the battery
	EVs are safer than conventional vehicles	N	Statistical records
4	EVs are more energy efficient and environmentally friendly than conventional vehicles	P	Powertrain efficiency Emission in urban area
	EVs are not more energy efficient or environmentally friendly than conventional vehicles as expected	N	Life-cycle analysis (LCA)
5	Slow charging will become the major approach in the future	P	Charging convenience (at home) Battery life, Smart grid, V2G
	Fast charging will become the major approach in the future	N	Charging convenience (charging duration) Ultra-fast charging, Limited driving range

P:Positive side, N:Negative side

5 Curriculum Electrification at Southern Illinois University Carbondale (J. Suda)

5.1 Background

Familiarization with electric vehicles is becoming critical to the automotive industry and its workforce, and it is vitally important that employees are properly educated with advanced technologies to become marketable within such a dynamic industry. Curricula, whether at the secondary or post-secondary education level, must encapsulate such technologies to reflect the current and future needs of what is and what will be the automotive industry as we know it [7],[7].

Since the Fall of 2015, J. Suda has been teaching, developing, and researching powertrain diagnostics training in regards to vehicles across propulsion system types (by means of either the internal combustion engine and/or electric machines) within SIUC’s Automotive Technology Department. The Department holds the only 4-year Automotive Technology program in the state of Illinois, as well as being the only Automotive Technology program that resides at a major research institute in the United States. Ms. Suda is currently “electrifying” the Automotive Technology curriculum at this research institute in order to set a standard at university (post-secondary) education level that will eventually bleed to the secondary education level.

5.2 Curriculum

EV-specific curriculum content should (and does) revolve around the following common componentry in industry today: high-voltage safety systems (such as safety interlock, capacitor discharge, and isolation fault circuits), energy storage (including both auxiliary and high-voltage battery technologies) and charging

infrastructure, vehicle propulsion (including electric machines and their control systems), and all associated control/temperature management (heating/cooling) systems for these major powertrain components [2], [6].

However, necessary curriculum electrification should involve more than just covering individual pieces of EV componentry, but integrate it within existing technical curricula in an elegant manner (opposed to covering topics into just a couple individual upper-level courses), since the associated subsystems are highly interconnected. Additionally, a restructuring process must occur with the current technical courses to integrate and accommodate for the EV curriculum, since the current structure is based solely around the internal combustion engine. After a restructuring of the curriculum, typical classes such as brakes, steering & suspension, transmissions/transaxles, heating & cooling systems, etc., will be unrecognizable compared to what they are today. Despite commonality with basic sensors (temperature, pressure, speed/position, etc.), diagnostics pertaining to the vehicle powertrain will need modification with electric vehicles coming into play, since the majority of diagnostics currently taught at the secondary and post-secondary education level cover drivability concerns with gasoline/diesel engines only.

Each area of automotive electrification study, not unlike its internal combustion predecessors, should include the following aspects for optimum comprehension of advanced technology: an overview of safety equipment and practices, a historical/societal background of the technology in general, the related emissions & environmental concerns, a fundamental overview of system/sub-system components, a description of each individual component's functionality with associated control systems, example diagrams showing integrated component interconnection/functionality/design, a description of fault-states and analysis within both the component and system/subsystem, a description of maintenance practices, and an overview of appropriate diagnostic equipment and practices. An inclusion of hands-on labs/modules also aid in overall vehicle familiarization [6][7], [7]. This progression through course content need not change- only the technologies at hand will differ.

References

- [1] Hayes, J.G., Cao, Y., Yuan, X., Suda, J.L., Yang, X., Friebe, J., Ogashawara, O., Renie, J.P., Sullivan, C.R., Goodarzi, G.A., "Global Perspectives on Electric Vehicle Education: Part II", EEDS 2020.
- [2] Hayes, J.G., Goodarzi, G.A., *Electric Powertrain Energy Systems, Power Electronics and Drives for Hybrid, Electric and Fuel Cell Vehicles*, ISBN: 978-1-119-06364-3, 1st edition, John Wiley & Sons, January 2018, 2nd Print October 2019.
- [3] Yuan, X. et al., "Energy and environmental impact of battery electric vehicle range in China." *Applied Energy* 157 (2015): 75-84.
- [4] Yuan, X. et al., "Method for evaluating the real-world driving energy consumptions of electric vehicles," *Energy* 141 (2017): 1955-1968.
- [5] Diao, Q. et al., "Life-cycle private-cost-based competitiveness analysis of electric vehicles in China considering the intangible cost of traffic policies." *Applied energy* 178 (2016): 567-578.
- [6] Caruthers, J.M. 2013. *Final Report- Indiana Advanced Electric Vehicle Training and Education Consortium* (I-AEVtec). TE Education Grant DE-EE002494. U.S. Department of Energy – NERL.
- [7] Hagedorn, L.S., Purnamasari, A.V. "A Realistic Look at STEM and the Role of Community Colleges," Sage Publishing, *Community College Review* 40(2), 145-164, 2012.

Global Perspectives on Electric Vehicle Education: Part II

John G. Hayes¹, Yue Cao², Xinmei Yuan³, Jessica L. Suda⁴, Xiaofeng Yang⁵, Jens Friebe⁶, Osmar Ogashawara⁷, John P. Renie⁸, and G.A. Goodarzi⁹

¹School of Engineering, University College Cork, Ireland

john.hayes@ucc.ie

²Energy Systems Group, School of EECS, Oregon State University, USA

³College of Automotive Engineering, Jilin University, China

⁴Transportation Education Ctr., Department of Automotive Tech., Southern Illinois University, USA

⁵School of Electrical Engineering, Beijing Jiaotong University, China

⁶Electrical Engineering and Computer Science, Leibniz University Hannover, Germany

⁷Centro de Ciências Exatas e de Tecnologia, Universidade Federal de Sao Carlos, Sao Paulo, Brazil

⁸Mechanical Engineering, Indiana Institute of Technology, USA

⁹US Hybrid Corp., Torrance, California, USA

Abstract

In this two-paper set, academics from universities in the Americas, China and Europe discuss educational and pedagogical developments at university level on electric vehicles (EV). EVs, whether battery (BEV), hybrid (HEV) or fuel cell (FCEV), are seen as being a crucial and essential component of sustainable living, and entire industries around the world are evolving to foster the development of electromobility. Thus, university curricula must also adapt. The authors, university by university, investigate the motivations, challenges and adaptations for EV education and the related pedagogy. Aspects of the related curricula are discussed with helpful insights on content and adoption. Challenges and future adaptations are often discussed. Academics from the following universities contribute to the papers, which are presented in two parts in order to cover the topic. Part I: University College Cork (UCC) and US Hybrid (USH), Indiana Institute of Technology (IT), Beijing Jiaotong University (BJTU), and Southern Illinois University Carbondale (SIUC); Part II: Jilin University (JLU), Oregon State University (OSU), Leibniz University Hannover (LUH), and Universidade Federal de Sao Carlos (UFCar).

See Part I for the introduction to this two-paper set [1].

1 Real-world EV Projects and Electric Aviation Curriculum at Oregon State University (Y. Cao)

In recent years, many EV companies, both major brands and start-ups, have blossomed in the San Francisco Bay area. In parallel, the aviation industry is also shifting towards electrification, in the form of unmanned aerial vehicles, regional jets, and long-range aircraft, and clustering in the Seattle area. Conveniently, the state of Oregon, the home of Oregon State University, is located in the Pacific Northwest of the United States, between Washington State and California. Portland, Oregon, hosts the headquarters of Daimler Trucks, a company which envisions zero emissions in the years to come. Ironically, the rapid electromobility industry growth on the west coast has had to greatly rely on student resources from the mid-western and eastern United States regions where the majority of the high-power schools reside. Oregon State University (OSU), the flagship engineering school in Oregon, offers one of the few EV-specific curricula in the US and has graduated many to the relevant industry. Beyond the EV course, OSU also

offers advanced power electronics, electric machines, motor drives, renewable energy systems, power systems and protection, and smart grids in order to provide a comprehensive education in the power and energy systems at both undergraduate and graduate levels [3].

Prior to joining OSU, Y. Cao worked in the automotive and aviation industries in Silicon Valley and Seattle. His main teaching philosophy is to bring industry practices into the classroom. Upon arrival at OSU, Dr. Cao revamped the electric vehicles course, which follows closely the Hayes textbook [2]. OSU runs on a quarter system, with only 10 weeks of course instruction, with 4 hours of lecturing per week. The content successfully covers vehicle dynamics, electric machines with a focus on permanent-magnet synchronous motors (PMSM), lithium-ion batteries and respective charging systems, and three-phase DC-AC inverters and thermal analysis.

In addition to the textbook homework problems, Cao uses several customized real-world projects to greatly benefit the students' learning. At the beginning, each student receives a unique EV brand/model from the latest years. Project 1 familiarizes students with MATLAB coding by exploring multiple drive cycles, characterizing a vehicle's rated torque, power, and speed, and plotting an acceleration curve. Project 2 dives into a PMSM's torque and speed relationships and their corresponding efficiency map. The project requests students to utilize the efficiency map to determine the vehicle's energy consumption and losses throughout a drive cycle. Project 3 models a lithium-ion battery pack which integrates with the rest of the drivetrain developed from previous projects. The battery must meet a range requirement while satisfying all the energy demands of the motor and the rest of the electric system. Finally, Project 4 requires students to model the PWM switched DC-AC inverters in Simulink/SimPowerSystems, realizing the actual power supply driving the motor terminals. It should be noted that feedback control such as field-oriented control is excluded but covered in a separate motor drives course. Throughout all four projects, students gain hands-on experience with the modelling and simulation software while understanding the entire vehicle drivetrain components and integration.

Given the strong presence of the aerospace industry in the Pacific Northwest and the emerging trend of aviation electrification, the EV course at OSU also highlights additional materials related to aviation propulsion systems. For example, these include distributed propeller-driven systems, altitude-thrust based mission profiles, high-power-density power electronics and battery packs. The OSU in-house lab assembled a complete propulsion stand for heavy-duty three-phase UAV power systems, a set-up which allows students to visually understand the propulsion mechanism and appreciate the electrification's potential impact in this industry[4][5].

2 Role and development of urban rail transit for sustainable urban transport based on industrial and academic experience (X. Yang)

2.1 Background

With ever-increasing populations, rising energy prices and environmental concerns, urban rail transit systems play more important roles for the sustainability of megacities. Rail transit has attracted much attention from both industry and academia due to the reduced congestion and CO₂ emissions. The Chinese government began to attach importance to urban rail transit in recent years, resulting in a large investment in this field. Before 2000, there were only three cities in China equipped with metro. But by the end of 2017, 34 cities in mainland China have opened urban rail transit with a total mileage of 5033 km. In addition,

according to the national development plan, the total mileage of operating urban rail transit was to exceed 6000 km in the year 2020 [6].

From a world perspective, the urban rail transit has gradually developed from only one type (i.e. metro) to a diversity of metro, light rail, and tram. Some famous cities, such as New York, Paris, London, Tokyo, Beijing, and Shanghai, have owned considerable scale of urban rail infrastructure, with a network of hundreds of kilometres [7].

However, the rapid development of urban rail transit requires staff with appropriate skills. By providing intelligence and professional service, and being fully involved in many milestone events in the development of rail transit in China, Beijing Jiaotong University (BJTU) has accumulated rich on-site technical experience in urban rapid rail transit. With such industrial background, BJTU offers a complete curriculum in rail transit, which covers the basic knowledge in rail transport, organization, planning, operation and design, etc. Taking the specialised courses of the School of Electrical Engineering in BJTU as an example, the curriculum construction and implementation of such a specialty in urban rail transit is next discussed.

2.2 Curriculum Construction and Implementation

Similar to electric vehicles (EVs), electrification is essential to urban rail transit, which is also the main concern in the School of Electrical Engineering. Six main specialised courses on urban rail transit are listed as follows:

- Introduction to Rail Transit Electrification
- Rail Transit Electrical Engineering
- Urban Rail Vehicles
- Traction Power Supply of Railways
- Electric Traction Drive and Control
- High-Power Energy Conversion Technology

The abovementioned curriculum teaching of urban rail transit firstly builds a general concept of the integrated system, which covers the fundamentals of urban rail transit electrification, vehicles, power supply, power energy conversion, traction drive and control. Besides, such curricula are also designed to lay a solid foundation, broaden the vision, inspire innovation and improve international competence for students majoring in civil engineering, mechanical engineering and its automation, electrical engineering and its automation, communication engineering and other professional disciplines.

Teaching activities include in-class teaching and assignments, with the aim of improving the students' ability to analyse and solve related practical problems and their experimental capabilities. The curricula combine the theory and related applied case studies. For instance, some examples of locomotive and other rail vehicles are introduced during the course. Additionally, research projects and experiments are carried out. The purpose is to fulfil the course's practice-oriented functions, and to enhance the students' practical abilities for their future study or career.

2.3 Conclusions and Key Learnings:

- Due to worldwide rapid urbanization, the urban rail transit attracts more concern from both industry and academia.

- Multiple specialised curricula in urban rail transit are developed for meeting the requirements of staff with appropriate skills.
- A mix of electrification, vehicles, power supply, power/energy conversion, traction drive and control helps students to establish the general concept of the integrated system in urban rail transit.

3 Federal University of Sao Carlos – Brazil (O. Ogashawara)

The electrical engineering course at UFSCar began in 2009, and the pedagogy of the course is such that the content was developed from real problem situations. A report from McKinsey Company identified the electrification of transportation as a trend in the automobile industry, so it is necessary to prepare students for this new market [8]. Combining the need for the market and the pedagogy of the course, the Electric and Hybrid Vehicles discipline was created as an optional discipline open to all interested students. As a real problem situation, the modelling and simulation of the Electric Formula SAE was proposed, since UFSCar has a team that participates in this competition organized by SAE.

The team presents on how both the competition structure and the vehicle work. From this meeting, the study of electric and hybrid vehicles begins, using active learning methodologies. Project-based learning, inverted classroom, team-based learning (TBL) and conventional classes are used. In project-based learning, developed from the presentation of the UFSCar Formula Electric Team, students discuss the knowledge needed to develop the EV modelling and simulation project. This is how the content of the discipline is defined, but based on its official planning. In this definition, a correlation is constructed with the disciplines of the course and it shows how the subjects can be integrated.

The development of the project is done in teams with a maximum of 6 students, depending on the number of students enrolled in the discipline. To compose the team, the MBTI methodology is used [9] and it is also sought to form the team with students from different courses (electrical, mechanical, production, materials, etc.). The 5-step team-based learning methodology is used as follows [10]. The first is “preparation” or individual preparatory reading of previously selected text, which all students must read. The second step consists of an individual readiness assurance test. The third step is the team readiness assurance test, to answer the same assessment, but now as a team, at this time there is a great learning, as there is a discussion among the team members to choose the correct answer. Feedback is used to correct the test. Thus, students have the correction of their assessments and can add the points obtained individually and as a team. The fourth step is a small lecture clarification. The fifth step consists in team application exercise.

In 2019, there were 26 students enrolled in the discipline, divided into 7 teams. After the presentation of the UFSCar Electric Formula SAE Team, students found that they needed to study the following topics: Electrical Machines, Power Electronics, Drive Control Systems, Battery, Vehicle Dynamics and Mechanical Parts (chassis, brakes, suspension). To complete the official planning, it is necessary to study hybrid-electric vehicles. Thus, some themes and texts were chosen for the application of the TBL (4–8). The course has been implemented in 16 weeks, one week for the TBL assessment, in the following week a normal class to complement the TBL text study. Table 1 shows the content per week, the TBL text and the reference text used. In the last 4 weeks the teams develop the project and present in last week.

The modeling and simulation were developed using MATLAB & SIMULINK software. The teams search the references and videos to learn how to use the Simulink Toolboxes.

The assessment modes were TBL assessment, individual test and the project. Only one student failed, 23% with grade > 8.0, 46% with 7.0 < grade <8.0 and 27% with 6.0 < grade < 7.0. These results and the projects presented by the teams show the successful outcome of these applied methodologies.

Table I – Course content by week

week	Contents	TBL text	Reference
1	Course presentation and introduction		
2	TBL1 - Architecture of Hybrid Electric Vehicle	[11]	
3	Topics in Architecture of Hybrid Electric Vehicle		[16][17]
4	TBL2 – Electric Machines	[12]	
5	Topics in Electric Machines		[2]
6	TBL3 – Power Converter	[13]	
7	Topics in Power electronics		[2]
8	TBL4 – Modeling and simulation	[14]	
9	Introduction to Vehicle Dynamics		[2][17]
10	TBL5 – Battery	[15]	
11	Topics in Batteries		[2]
12	Chassis, brake system and suspension		[17]
13	Project – modeling and simulation		[18]
14	Project – modeling and simulation		
15	Project – modeling and simulation		
16	Project presentation and conclusion		

4. Electric Vehicles and Energy Transition within University Education at the Leibniz University Hannover (J. Friebe)

4.1 Background

The Gottfried Wilhelm Leibniz University Hannover (LUH) was founded in 1831 in Hannover, Lower Saxony, Germany. It is a technical university (TU) and part of the German TU9, an alliance of leading technical universities in Germany. Currently, the University has approx. 30,000 students, approx. 3,000 researchers, 9 faculties, and more than 180 institutes. In 2018, the University was able to acquire more than 120 million Euro in third-party funding and had partnerships with 167 Universities worldwide [19]. The Institute of Drive Systems and Power Electronics, as one of the Institutes of the faculty of Electrical Engineering and Computer Science, has a strong traditional connection to automotive, industrial drives and renewable energy research and industry. The merging of Drives Systems and Power Electronics (IAL) into a joint institute reflects the technological development towards integrated systems, especially in the fields of automotive, industrial drives, renewables (especially wind) and also the electrification of aircrafts for more and all electric aircrafts. Additionally, the Power Electronics Group has also a strong focus on Microgrids, Modular-Multilevel-Converter and Photovoltaic Converter [20]. Due to the funding structure in Germany, typically joint projects of university and industry partners are applied for at funding calls from national ministries. These projects are often organized or coordinated by regional partners, even if it is not a must. Figure 1 shows the location of some of the companies working in the field of automotive and renewable energies and having a cooperation with the IAL within former or current projects. It can be seen that there is a strong accumulation of regional partners as well as an accumulation around automotive manufacturers and industrial centers. Figure 2 shows an example of a drivetrain of a public funded project.

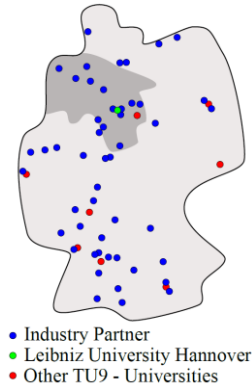

Figure 1: Location of the Leibniz University Hannover, Industry Partner and the other TU9-Universities in Germany. The federal state Lower Saxony is highlighted in grey.

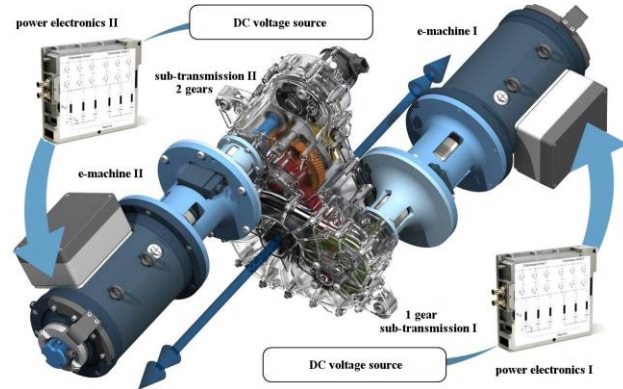

Figure 2: Drivetrain of the Speed2E Project, covering speed of up to 30,000 rpm for two sub transmissions [21]

1.2 Teaching and Research

The teaching within the context of automotive and energy transition is mainly covered within courses offered in the Bachelor and Master Programmes for Electrical Engineering and Information Technology, Power Engineering, Mechatronics and also within two English-language Master's Programs Energy Technology and International Mechatronics. The students are given mainly fundamental mandatory lectures within the first four semesters of the bachelor programs but a high freedom in later semesters, and especially in the master programs. This gives the opportunity for a very individual focus in the area of automotive and energy transition topics. The idea behind this structure is to create strong foundations in engineering education to enable students to work in interdisciplinary teams. The automotive and energy transition related lectures are starting with “Basics of Electromagnetic Power Conversion”, followed by lectures in the fields of drives and power electronics, as shown in Fig. 3.

A benefit of the third-party funding structures in Germany accompanied by the high degree of freedom for the students in 5th and 6th bachelor semesters and in the master semesters is the possibility for student employments (typically up to 40 h/month) within research projects at the institutes. Based on this there is the opportunity within the education to enthuse the students for scientific topics of research projects. With this strong connection between the institute and students after up to two semesters in the Bachelor's and up to four Semesters in Master's, there is often the possibility for an employment as “Research Associate”. Therefore, the research associates are strongly connected to actual research within industry while also having the benefit of a university employment setup with a high degree of freedom within their own research activities leading to their PhD after typically around five years. While missing the system aspects, as mentioned especially in this paper set, an industrial applications lecture series is offered. This lecture series includes presentations from alumni of the IAL and from experts on specific topics covering system aspects which are not part of the curricula, e.g. on electric vehicles from German car manufacturers.

4.3 Comparison with the programs discussed by the other authors contributing to this paper

The main difference with the other universities in this paper set is the missing focus on electrical vehicles as a system within the curricula at the Leibniz University Hannover. Instead, students can decide on their specific topics as parts of their curriculum on their own. For helping them finding their individual focus, the industrial applications lecture series is offered to all students, either undergraduate or graduate. The

difference to other universities might also be based on the specific background of the industry in Germany being very much focused on automotive applications. German students often have a broad overview of automotive systems and their electrification, and their wish to work on certain topics in the automotive field can easily be addressed through student employment and internships parallel to their studies. Nevertheless, having more than 50% international students in masters in electrical engineering in the last years, and numbers still increasing, the situation is changing fundamentally [19]. Therefore, there are already drafts in preparation for examples of curricula within the field of automotive and energy transition, to help the students in their decision to pick the right lectures if they plan to work within the respective field. Here the experience and examples from other universities discussed in this paper will be quite useful.

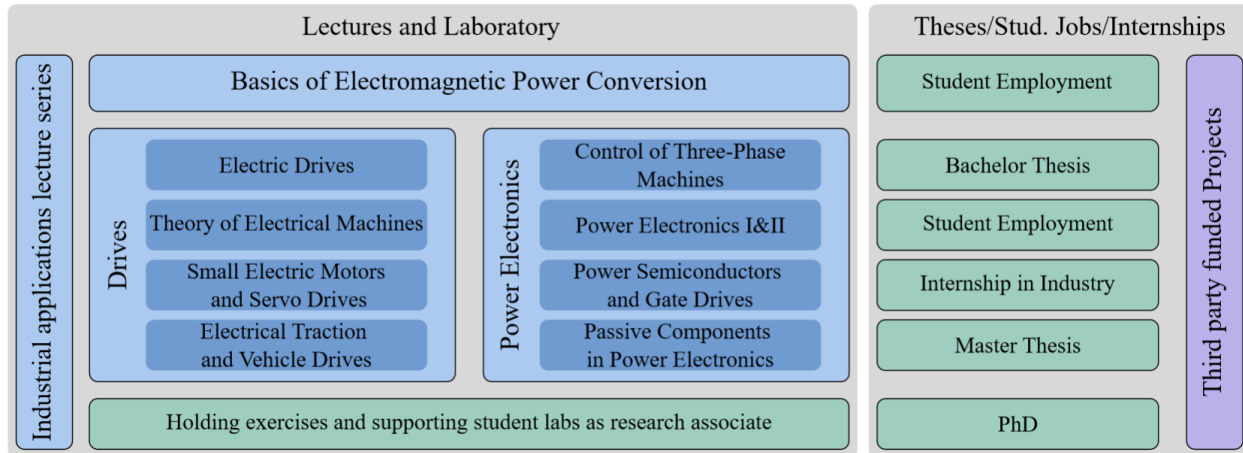

Figure 3: Lectures, laboratories, theses, job opportunities and internships within the electric vehicle education at Leibniz University Hannover.

4 Conclusion

With the significant shift towards electromobility within the transportation industry, educators from around the world are transforming curricula from the former focus on the internal combustion engine to that of the electric powertrain. The integration and interconnection of related content that enables these modernized vehicles to operate, such as energy storage, power electronics, and electric machines, comes as no small challenge. Due to frequent advancements in vehicle hardware and software technology, curricula require continuous updating. Additionally, the sustainability of greener technologies and their environmental impacts are becoming an important topic of discussion in the classroom. Strategically adapting and updating this curriculum will ensure that students are prepared to work in the reshaped transportation industry of the future.

References

- [1] Hayes, J.G., Cao, Y., Yuan, X., Suda, J.L., Yang, X., Friebe, J., Ogashawara, O., Renie, J.P., Sullivan, C.R., Goodarzi, G.A., “Global Perspectives on Electric Vehicle Education: Part I”, EEDS 2020.
- [2] Hayes, J.G., Goodarzi, G.A., *Electric Powertrain Energy Systems, Power Electronics and Drives for Hybrid, Electric and Fuel Cell Vehicles*, ISBN: 978-1-119-06364-3, 1st edition, John Wiley & Sons, January 2018, 2nd Print October 2019.

- [3] T. Kilgore, A. Thurlbeck, Y. Cao, T. Brekken, C. Li, P. T. Krein “PowerBox: A Modern Power Electronics Education Toolbox Using Si and SiC Devices,” in *Proc. IEEE Applied Power Electronics Conference and Exposition (APEC)*, 2020, pp. 1-6.
- [4] A. Thurlbeck and Y. Cao, “Analysis and modeling of UAV power system architectures,” in *Proc. IEEE Transportation Electrification Conf. (ITEC)*, 2019, pp. 1-8.
- [5] Y. Cao and A. Thurlbeck, “Heavy-duty UAV Electric Propulsion Architectures and Multi-timescale Multi-physics Modeling,” in *Proc. AIAA/IEEE Electric Aircraft Technologies Symposium (EATS)*, 2019, pp. 1-13.
- [6] Zhang, D., Jiao, J., "How Does Urban Rail Transit Influence Residential Property Values? Evidence from An Emerging Chinese Megacity," *Sustainability-Basel*, 2019, 11(2), pp. 534.
- [7] Li, W., "Development of a vocational college course on metro service telephone communication system maintenance based on work process," *World Transactions on Engineering and Technology Education*, 2014, 12(2), pp. 289-293.
- [8] Knupfer, S.M. et al. *Electrifying insights: How automakers can drive electrified vehicle sales and profitability*, McKinsey & Company, 2017.
- [9] Myers, Briggs. *Introduction to type: a guide to understanding your results on MBTI instrument*, CPP, Inc., 1998.
- [10] Najdanovic-Visak, Vesna. “Team-based learning for first year engineering students,” *Education for Chemical Engineers Journal*, Elsevier, 2016.
- [11] Chan, C.C. “The State of the Art of Electric, Hybrid, and Fuel Cell Vehicles,” *Proceedings of IEEE*, vol. 35, n.4, April, 2007.
- [12] Zhu, Z.Q., Rowe, David. “Electrical Machines and Drives for Electric, Hybrid, and Fuel Cell Vehicles,” *Proceedings of IEEE*, vol. 35, n.4, April, 2007.
- [13] Lai, J.S., Nelson, D.J. Energy “Management Power Converters in Hybrid Electric and Fuel Cell Vehicles,” *Proceedings of IEEE*, vol. 35, n.4, April, 2007.
- [14] Gao, D.W., Mi, C., Emadi, A. *Modeling and Simulation of Electric and Hybrid Vehicles. Proceedings of IEEE*, vol. 35, n.4, April, 2007.
- [15] Burke, A.F., “Batteries and Ultracapacitors for Electric, Hybrid, and Fuel Cell Vehicles,” *Proceedings of IEEE*, vol. 35, n.4, April, 2007.
- [16] Ehsani, M., Gao, Y, Longo, S., Ebrahimi, K.M. *Modern Electric, Hybrid Electric, and Fuel Cell Vehicles*, 3rd Edition, CRC Press, 2018.
- [17] Khajepour, A., Fallah, S., Goodarzi, A. *Electric and hybrid vehicles: a mechatronic approach*. John Wiley & Sons, 2014.
- [18] Miller, S. Hybrid Electric Vehicle Modeling and Simulation: https://www.mathworks.com/videos/hybrid-electric-vehicle-modeling-and-simulation-81751.html?s_tid=srchtitle
- [19] Leibniz Universität Hannover, Zahlenspiegel 2019.
- [20] Institut für Antriebssysteme und Leistungselektronik (IAL), *Institute Report* 2017/2018/2019.
- [21] Project “Speed4e“, <http://www.speed4e.de/Joomla/index.php/en/>, accessed 04.03.2020.

Perspectives on Challenge-Driven Engineering Education for a Sustainable Future

J. Hedvall, H. Lindberg, A. Rosén and L. Gumaelius

KTH, Royal Institute of Technology, Sweden

lenagu@kth.se

Abstract

Engineering education has changed and evolved over decades in harmony with societies challenges. Today, sustainable development is of greatest importance and one way of equipping future engineers with the competencies to tackle this challenge is through Challenge Driven Education (CDE). This study takes on an exploratory approach when studying the implementation of CDE as it is formed at two different universities, one in Sweden, and one in Tanzania. By interviewing key-actors such as teachers and stakeholders who are in one way or another engaged or are about to become involved in CDE, an investigation has been conducted in order to understand how these key-actors view CDE as a successful pedagogical approach for educating engineers of the future. First, a question was asked on which competencies for sustainability could be considered important in future engineers. Second, the participants were encouraged to tell how CDE could develop from their perspective. Results show that the depiction of key competencies for sustainability correlates well with the participants views of what is important for future engineers, although it is evident that good communication between stakeholders and students/teachers about what is expected to train during a CDE course is paramount. The study also shows the importance of stakeholders trusting each other and having a common picture of what a CDE collaboration should lead to in order to achieve the best possible results of such training.

1. Introduction

The grand challenges for humanity in the 21st century, for example as expressed by UN's 2030 Agenda and the 17 Sustainable Development Goals, are calling for substantial transformations of our global society, to ensure a healthy planet and sustainable living conditions for ourselves and future generations (UN, 2015). These challenges are also drivers of change for our education systems, where the traditional focus on developing students' knowledge and analytical skills within specific disciplines has to be complemented by also developing students' knowledge and key competences for sustainability for example: systems-thinking; critical-thinking; abilities to collaborate across disciplines, cultures and contexts; and integrated problem-solving competences. Several researchers have worked on the concept of key competences for sustainable development. A frequently used description of these is UNESCO's list (2017), which is based on a broader literature review and provides a compilation on a variety of studies. UNESCO describes eight different key competences with some explanatory sentences about each in the book. Such competences cannot be taught through conventional teacher-centred approaches, but instead require students-centred, action-oriented, interdisciplinary, and transformative learning approaches (e.g. UNESCO 2017).

An evolving group of learning approaches for sustainable development are referred to as challenge-driven, challenge-based, or problem- and project-based (e.g. Wiek et al 2014, Malmqvist et al 2015, Ibwe et al 2018, Högfeldt et al 2019). In common for these learning approaches is that learning takes

place in the context of complex real-world issues. They can further be characterized as student-centred, self-directed, and collaborative, and they generally involve interaction with various external stakeholders. These approaches could provide excellent conditions for developing students' key competencies for sustainability, also enhancing the interaction between universities and the surrounding society and allowing students to have impact on the sustainable development of the society already during their studies. However, the real-world issues constituting the context for the learning, the changing roles of students as well as teachers, and the involvement of external stakeholders as a third actor, all adds complexities, making these learning approaches highly demanding to implement.

With the aim of mutual capacity building for global sustainable development, the Royal Institute of Technology (KTH) in Sweden has joined forces with the University of Dar es Salaam (UDSM) in Tanzania, and a few other partner universities within the KTH Global Development Hub (GDH) network. The collaboration involves development of a concept for challenge-driven education (CDE) and related teaching and learning methods, implementation of the CDE concept in courses at the involved universities, a teacher training program, and a joint student exchange program. The CDE concept can be described as a solution- and impact-oriented project-based learning approach where multi-perspective student teams collaborate with various external stakeholders in projects that are addressing societal challenges related to the Sustainable Development Goals in UN's 2030 Agenda. A distinguishing feature of this CDE concept is that it starts earlier and aims farther compared to 'ordinary' project-based learning approaches, in the sense that the starting point for the students' projects and learning are complex ('wicked') societal challenges and that the aim is that the solutions developed by the students can be taken further to impact on the sustainable development of the society.

The addressed challenges are contextualized by involving local stakeholders who can also be potential receivers and exploiters of the results. The assignments have so far constituted of a variety of challenges where, for example, the students have worked on creating a safer environment for those who are outdoors in the evening in a less safe area, or to develop a system that effectively handle received reports of faults on one municipality's water supply.

The here presented study investigates the implementation of CDE at KTH and UDSM. The primary research question is: *To what extent and in what way do teachers and stakeholders involved in CDE express the need for key competencies for sustainable development in future engineers?* The answer to this question is important for the understanding of how CDE can be improved with regards to teachers' and stakeholders' conceptions of key competencies for sustainability which in turn will affect the students learning and development of these competences. The study was performed through semi-structured interviews followed by deductive thematic analysis. In addition to providing data for answering the primary research question, the interviews have also given various other perspectives that can be used for further enhancing CDE and other similar learning approaches.

2. Methodology

A total of 15 external stakeholders and teachers involved in CDE were participating in this study. Two teachers are involved in two different CDE courses at KTH. The other teachers are all involved in one CDE course at UDSM, where three also have earlier experiences as students in this CDE course. The participating external stakeholders are so called challenge-providers, i.e. representatives from companies and other organizations who have provided challenges for students to target in CDE projects. Five Swedish external stakeholders/challenge providers were involved, however it unfortunately turned out to be difficult to reach external stakeholders/challenge providers in Tanzania. The selection is hence for practical reasons somewhat limited and not completely balanced between Sweden and Tanzania. The study and the generated results should therefore be seen as indicative.

A qualitative approach was applied using semi-structured interviews. An interview guide was created consisting of three main questions, that were asked to all participants, and several sub-questions, that were not necessarily asked, in order to gather data in a fulfilling manner. The questions were mainly open-ended:

- What would you say are the most important competences engineering students need to acquire to be able to contribute to the SDGs?
- What competencies do you think engineering students develop by taking part in challenge-driven projects?
- What are your experiences and impression of CDE-projects?

The interviews lasted between 30 and 65 minutes. The interviews conducted in Sweden were held in Swedish and the interviews conducted in Tanzania were held in English. All interviews were consensually recorded, and all relevant parts were transcribed verbatim.

All interviews began with the interviewer introducing the 17 Sustainable Development Goals, to frame the interview in the context of sustainable development and explaining the term *competence* as an interplay between knowledge, skills, and attitudes. However, the concept of key competencies for sustainability were not mentioned, since it was later used as framework for the analysis.

The analysis followed the phases of thematic analysis similar to the procedure presented in Braun and Clarke (2006, p.87). Initially the transcribed data was sorted in two main *categories*: 1) statements considering the importance of certain competences, skills or attributes for future engineers and 2) statements about CDE as a phenomenon.

UNESCO's eight key competences for education for sustainable development were then used as pre-determined themes for category 1, and a deductive approach was taken when mapping the data towards those competencies. Competences mentioned that could not be related to any of the key competencies were sorted under a theme named miscellaneous.

The process of color-coding and sorting all quotes was followed by a process in which the quotes were shortened to form manageable phrases to enable comparisons between quotes and UNESCO's definitions of the key competencies. For example, the quote;

And it's very different if you're at a small company with four employees owned by a person also working there with you, or if you're in a multinational company with sites worldwide... I think that when you have graduated, you are like, so sure of what you will do. And suddenly you end up somewhere and see that people do things in a different way. You may think that's not right since you learned it differently. To, like understand that you are part of a context. That's what I think [is important].

has been abbreviated to

- *understand one's role in a group and*
- *interact in a working context.*

3. Findings

3.1 Expected competences for future engineers

Table 1 summarize what emerged in the deductive analysis for category one, representing competencies, skills and attributes the participants see as important/necessary in future engineers. The phrases are by no means quantitative, why there is no direct correlation in how many phrases are presented in the results and how many participants have mentioned each theme.

Table 1: Competences desired in future engineers according to the participants, mapped against the eight key competencies for sustainability outlined in UNESCO (2017).

Competencies desired in future engineers according to the participants: They need to:	Mapped key competency
<ul style="list-style-type: none"> • possess in-depth expertise within their field but also fit it into a context, because it won't be useful on its own • understand the bigger business • be "like Sherlock with a magnifying glass and at the same time keep an overview perspective" • understand the environment in which solutions are implemented • be able to deal with uncertainty, it is extremely important that "what I think of today will become even more important in the future" • understand that not only one solution can fit all SDG:s • be able to take on complex challenges 	Systems-thinking competence
<ul style="list-style-type: none"> • have competence to see sustainability in the future, the past is the past, but what comes next? • they must be able to make conscious choices for sustainability, which may be difficult as the financial goals are often prioritized for companies • be very socially responsible, not developing solutions which is limited to be good for now/the near future • think about what consequences does a solution have for someone? • be able to develop adaptive solutions 	Anticipatory competence
<ul style="list-style-type: none"> • think sustainably in each subsequent part • not forget about the issue of sensitivity to the environment • have a dynamic awareness of the environment regardless of workplace • have the mindset of a socially responsible engineer 	Normative competence
<ul style="list-style-type: none"> • be innovative • be able to prioritize • use the right competence at right time • be efficient and propose resourcefully responsible solutions • think outside the box • know how to use processes to transform knowledge into useful products, services, or technologies 	Strategic competence
<ul style="list-style-type: none"> • know how to collaborate and work with others • be able to adapt • understand one's role in a group • know how to forward information and make people understand it • be able to form teams • be good at explaining what he or she needs • be able to share skills • be able to lead groups of people • strive towards improving projects management skills • have multidisciplinary competence, which means to learn things not just from one's own profession, but from the other people one encounter in the field • have communication skills • be able to say: "I know this, how can my knowledge help to find a way forward?" 	Collaboration competence
<ul style="list-style-type: none"> • not be yes-sayers but critical thinkers • observe and learn through critical thinking and reasoning • be critical towards unsustainable technical solutions • believe in sustainable development 	Critical thinking competence
<ul style="list-style-type: none"> • have empathy, to see the bigger picture and not just what's profitable for me at this instant • be brave, to dare to bring in fresh knowledge • see the applications of what one is learning • interact in a working context • understand the connection between sustainability goals and one's own professional role 	Self-awareness competence
<ul style="list-style-type: none"> • face a challenge by opening it up and then break it down • have the ability to choose among numbers of opportunities, what is the right problem to solve? 	Integrated problem-solving competence
<ul style="list-style-type: none"> • know the facts within one's domain • be curious and committed • be interested in taking initiatives • be interested and willing to learn and understand • be efficient • be expressful • have endurance • understand the perspective of industry • know market strategies • become a businessperson, willing to start up a company or a business 	Miscellaneous competences, skills and attributes

The participants reflected upon what competences future engineers will need both from a general point of view and in relation to sustainability and the SDG:s. A wide range of desired or needed competencies

were expressed where some statements were very concrete, like the ability to form teams and to work together, whereas other statements were broader and more abstract, like the importance of individual attitude and need for social responsibility, and to see the big picture and not just what is profitable right now.

Within the theme of systems thinking, the participants provide a description that is in good agreement with the description given by UNESCO. Although not all stakeholders describe every aspect, the overall picture is that future engineers need this competence. Another theme where the depiction made by UNESCO is matching the quotes from the participants very well is collaboration, which is described relatively exhaustively by the participants. Critical thinking is also expressed by the participants, just as by UNESCO as being able to question prevailing norms and values. The ability to take a stand for sustainable development is also associated to this competence.

The analysis further shows that for some of the themes, it is clear that the participants do not consider competences as extensively as UNESCO, even if certain attributes are demanded. Anticipatory competence is such an example where UNESCO depicts a more complex way of how one may relate to the future, including predicting risks, or being able to predict several different future scenarios that may result in the ability of placing different demands on contemporary solutions. Normative competence is another theme where it can be seen that a more holistic view of norms and values is described by UNESCO compared to what has been expressed by the participants.

On the other hand, other themes are described more extensively by the participants. Even though the core of being strategic is described in similar ways, as being innovative and creative in developing sustainable solutions, the participants add an attribute to the competence, a desire to use the right skills at the right time. Within the theme Self-awareness participants emphasize the importance of having good self-confidence, something that is not clearly described by UNESCO.

The last presented theme is about the competence integrated problem solving. Here are two phrases where the content only partially corresponds to the definition by UNESCO. Nor do these two quotes completely match the description given which could mean that none of the participants see the need for students to have problem-solving ability. However, it may also be that attributes of the problem-solving competence are reminiscent of other competencies, and hence it may be that the participants certainly think that this is an important competence, but they have not expressed it in a whole. As expressed by UNESCO, integrated problem solving can be seen as a meta-competence which is about making integrated use of the other competences.

The participants also expressed a number of desired or needed attributes and skills from graduated engineers that were not possible to match with the key-competencies. The importance of having knowledge in one's field is emphasized, something that is not seen as a key competence. In any case, knowledge is seen as the basis for being able to act in a sustainable way also according to UNESCO, the key-competencies should be seen as something one need in addition to knowing one's area.

3.2 Other opportunities for refining the CDE concept

All participants are unanimously positive to CDE as an approach for enhancing engineering education and they are positive to further engagement. The interviews give clear indications on that CDE can support students in developing professional skills as well as key competencies for sustainability, where answers in particular can be related to systems-thinking, collaboration, self-awareness, and integrated problem-solving competences. One challenge provider for examples indicates how students apply and develop system-thinking and integrated problem-solving competences in CDE projects as follows:

They [the students] used multiple methods to reach different kinds of conclusions. So they didn't choose just one method, they didn't just do interviews and settled for that, but they looked at multiple ways to gather information and multiple ways to process the data they gathered.

Hence, the general experience is positive, and all interviewees see large potentials and mutual benefits in CDE. However, several differences in conceptions between participants were also identified, which highlights potential barriers, needs and opportunities for further refinements of the CDE concept and its implementation. Several participants for example expressed the need for building trust between academia and industry as crucial for succeeding with engaging industry representatives as challenge-providers in CDE projects. One Tanzanian teacher for example expresses that:

The first thing is to build trust. The trust from the industry ... they don't even know we[academia] exist in terms of offering solutions to them. What they know is we only offer them the skills they can tap in terms of employment. So, our relationship is only because they hire people from the university to work for them.

Some of the interviews indicate that approaches taken for building trust is to direct the students' projects towards 'pleasing' the challenge-providers in the sense that the students' solutions should be directly realizable and implementable. One teacher for example expresses that:

...[the students] come up with really practical solutions ... not something abstract or imaginary that cannot be implemented, but something that is really down to the ground.

whereas another teacher describes that:

CDE is solely and entirely dedicated to solve their [the challenge-providers'] problems ... not anyone else but theirs.

On the other hand, another teacher who also has earlier experience from CDE as a student, highlights limitations in such approach:

...you have to solve that problem, but in the end, you have to have a contribution to the knowledge ... the general knowledge ... so you might find that "ok, I can do this and that ... but that solution is already there, maybe somewhere else" ... so what is your contribution?

More open-ended approaches can be traced in the interviews, where it is indicated that teachers have instructed external stakeholders/challenge-providers not to intervene too much in the students' processes, as for example expressed by one of the Swedish challenge-providers:

...one of the most important aspects was that I was not to intervene. My task was to supply them [the students] with data without affecting them. I was not to give them the answer, because that's the main issue. That we have often already answered the question before we asked it, without knowing if it's the right answer ... we just suppose it's right ... [but we should] try to be open to our preconceived notions being wrong.

Such approaches could however also be problematic, as expressed by another challenge-provider:

I think it's important to know ... why should I spend time on this? ... what will I gain? ... why should I work with you specifically? ... why you can do it better than we can ourselves ... what's your method to reach a good solution ... are you making a product? ... does it involve softer values like mapping a culture? ... what can I expect to get at the end?

Stakeholders also express that engagement in CDE projects can be very time consuming, and one suggested that the teachers should be clearer about what efforts are expected from them:

Also, clarify what's expected of you. If you don't, I think there's a risk that people won't dare doing it since they don't have the time. But if you say "we expect 20 hours of your time over 15 weeks", you can probably live with that. But if you get the impression that it's 20% over 15 weeks, then you won't have the time. So just the fact that you don't know might make you pass the opportunity.

5. Conclusions

The primary purpose of this study is to increase the understanding of how teachers' and external stakeholders', involved in CDE, views of future competencies match the depiction of key competencies for sustainability, but also, when applicable, to develop the description of each key-competencies by introducing new aspects that stakeholders may provide. These results indicate that teachers' and external stakeholders' views and the UNESCO's key-competencies are in good agreement, however, it should be emphasized that even though it seems that virtually all competencies have been mentioned by the participants, it is far from everyone who has mentioned all competencies. Through this analysis, one can understand the importance of that stakeholders, both from university and industry, discuss and agree on the desired competences of future engineers in order to create consensus on what can be achieved with, for example, challenge-driven education.

Another aim was to better understand how the CDE concept can be refined to better fit stakeholders' expectations. Limiting the students to work on commission by one single challenge-provider, only addressing and developing a tailored solution to one specific problem within that organization, could provide short sighted values for the challenge-provider and opportunities for students to apply their disciplinary knowledge and develop professional skills. However, to reach the full potential of CDE regarding development of students' key competencies for sustainability and solutions to the addressed challenges with potential for innovation and actually impact on sustainable development beyond the horizon of one specific challenge-provider, may require more open-ended challenges for the students to work with, more open and dynamic relations between the students and stakeholders, and allowing for larger risks regarding the practical usefulness of the project outcomes. The key for success will be good dialogue and trust building between all involved actors (teachers, students, and external stakeholders) and clarification of what is expected by each party and what can be expected with emphasis on long-term capacity building and innovation for sustainable development.

References

- Braun, V., & Clarke, V. (2006). Using thematic analysis in psychology. *Qualitative Research in Psychology* (3), 77–101.
- Bryman, A. 2012. *Social Research Methods* (4.ed.). Oxford: Oxford University Press.
- Högfeldt AK, Rosén A, Mwase C, Lantz A, Gumaelius L, Shayo E, Lujara S, Mvungi N, 2019. Mutual Capacity Building through North-South Collaboration Using Challenge-Driven Education. *Sustainability*, **11**(24).

Ibwe, K. S., Kalinga, E. A., & Mvungi, N. H. 2018. The Impact of Industry Participation on Challenge Based Learning. *International Journal of Engineering Education*, **34**(1), 187–200.

Malmqvist, J., Kohn Rådberg, K., & Lundqvist, U. 2015. Challenge-Based Learning Experiences. *Proceedings of the 11th International CDIO Conference*. Chengdu University of Information Technology, China.

Wiek, A.; Xiong, A.; Brundiers, K.; van der Leeuw, S. 2014. Integrating Problem- and Project-Based Learning into Sustainability Programs. *Int. J. Sustain. High. Educ.*, **15**(4), 431–449.

UN 2015. *Transforming Our World: the 2030 Agenda for Sustainable Development*, UN Resolution A/RES/70/1.

UNESCO 2017. *Education for Sustainable Development Goals – Learning Objectives*, ISBN 978-92-3-100209-0.

Urban Agriculture in office buildings, applications for the Teaching of office buildings design projects for Architectural students in Vietnam

First A. Hai-Yen Hoang

Head of Architecture Department, Faculty of Architecture and Art, Ho Chi Minh City University of Technology (HUTECH), 475A Dien Bien Phu Street, 25 Ward, Binh Thanh District, HCMC, Vietnam

hh.yen84@hutech.edu.vn

Abstract

The speed of urbanization is increasing rapidly in Vietnam's big cities. The population is crowded in big cities and office buildings are rising higher and higher. The demand for office building designs have increased, making teaching Architectural students to master sustainable design trends for office buildings necessary at Architecture Universities in Vietnam. The office buildings that have been built are mainly glass-covered concrete blocks, using artificial air-conditioning equipment that release a large amount of CO₂, polluting the environment, increasing urban heat, and little attention is given to the development of green spaces. Bringing Urban Agriculture into office buildings is a viable new direction that many developed countries have applied. This research analyses the current situation of office buildings that have been built in Vietnam to assess the necessity for training Architecture students about new sustainable design trends. Since then, the article proposes the application of solutions for Urban Agriculture in the design of office buildings, proposed in Teaching Architecture students in Vietnam, such as using vegetable growing boxes, using LED lights, vegetable growing towers, Aquaponics, and using automatic vegetable growing machines. Giving students access to new sustainable design trends while they are studying is a positive move to create a future generation of Architects who have mastered sustainable design solutions to construct green buildings and cities that are close to nature, and also support life and human development.

Key words: Urban Agriculture, green office, Architecture students, sustainable design, Vietnam.

1 Introduction

The speed of urbanization in Vietnam has been increasing in recent years. The development of high-rise buildings hasn't been accompanied by the maintenance of green areas, which makes urban areas in Vietnam a concrete jungle, releasing a large amount of CO₂ into the air, leading to the polluting of the environment, the greenhouse effect, and the urban heat island phenomenon. Urbanization reduces the area of Agricultural land, causing Urban Agriculture to develop. Since the end of the 20th century, Urban Agriculture has become a trend in the process of urban development in many countries.

High-rise office buildings are currently the type of buildings that are built a lot in Vietnam's big cities, requiring Architects and Architecture students to master new principles and sustainable design trends for this building type. Currently, office buildings are built mainly of glass-covered concrete blocks, using artificial air conditioners. Few investors are interested in putting more trees into the buildings, planting agricultural trees to turn them into self-sufficient buildings, helping to ensure spaces are green, and transmitting positive energy to employees. Scientists have shown that humans have always needed to be

near nature, so efforts to bring green spaces into office buildings are now essential. This is also a new research direction in Teaching Architecture students to do office building design projects at universities in Vietnam.

With the advancement of science and technology, the prevalence of green technology and smart buildings are growing. In addition to the use of natural energy sources, reuse of waste can turn office buildings into vertical farms. This is a positive direction for a green office buildings model in the future.

Developed countries have successfully applied the model of Urban Agriculture in office buildings. Vietnam can fully apply this model when designing office building. This is a new and feasible direction that needs to be taught to Architecture students in Vietnamese universities in order to create a generation of Architects who design with sustainable development and human protection in mind.

1.1 Urban Agriculture

Urban Agriculture is defined as the use of small areas, vacant lots, gardens, lawns, balconies, terraces, and other available unused space in big cities to plant trees or raise poultry and small animals in accordance with conditions of land, climate, and hydrology. The aim is to ensure ecological balance, create production efficiencies, economic efficiency, and contribute to improving the quality of the environment. In addition, all or some of the produce is commercialized. (Huong-Giang, 2018)

1.2 Green office building design projects

Green office building design is taking advantage of the plants and flowers function to decorate the office interior, so that the design is appropriate and highly aesthetic. Office supplies are made from recycled materials. The green of trees not only brings beauty, but also helps to filter air and reduce stress. An office that is called a green office will ensure the following elements: efficient use of energy, an indoor environmental strategy, advanced architecture, identity, and sustainability. (Luc-Binh, 2018)

Office building design projects form part of the 3rd year of Architecture studies in Vietnam. They require students to design a medium-sized office building with a construction area of about 600- 800m², with full public utilities and offices for lease. Students should be encouraged to have solutions for green office and use eco office design principles in these projects.

2 Research Methodology

This paper is a qualitative research, using a mixed method consisting of the data synthesis method and expert method. The data synthesis method is applied to analyze the situation of office buildings that have been built in Vietnam, thereby pointing out the shortcomings and the importance of training Architects in sustainable design trends. The data synthesis method is also used to refer to the experience of Urban Agriculture development in office buildings around the world. The expert method is applied to collect Urban Agriculture models that are being used in Vietnam, thereby providing solutions as design principles to apply those models in different spaces in the office buildings, combined with green architecture solutions to create sustainable eco office buildings.

3 Experience of applying Urban Agriculture in office buildings around the world

3.1 The Japanese experience

The headquarters of Pasona Group has the main goal of creating a building in harmony with nature. This is the workplace of 1500 employees, trained in farming by agricultural experts. All employees grow their own food. The building is a typical model of Urban Agriculture in high-rise buildings, focusing on environmental protection. All 9 floors are covered with green spaces, using energy-saving light sources and advanced irrigation techniques. The temperature inside the building is carefully controlled to ensure the optimal yield of the plants. After witnessing and participating in tree planting and tending activities, 80% of employees said they felt positive, energized and increased their motivation to work. Another advantage of growing houseplants is that there are no pests. Therefore, no pesticides are required and all harvested products are 100% organic. (Hong-Nhung, 2018)



Figure 1: Trees help offset carbon Emissions (Source: Kono Designs).



Figure 2: Employees are harvesting rice (Source: Dezeen).

3.2 The Indian experience

The Hyperion building, designed by Belgian Architect Vincent Callebaut, is an eco-friendly building with lush green gardens. The ecological building is 36 floors high and consists of 1,000 apartments, along with office area and workspace, a gym, restaurants and a swimming pool.



Figure 3: Hyperion is a sustainable Agricultural project that is resistant to climate change (ABIGAIL BEALL FOR MAILONLINE, 2016).

The Hyperion building will be designed with urban farms and small livestock farms producing eggs and milk. It is designed to work under the model of "self-sufficiency". It is estimated that every square meter in this farm can produce 20 kg of organic fruits and vegetables.

The buildings will be equipped with solar panels. Energy for the buildings is generated through wind turbines and photovoltaic systems. In addition, Agricultural by-products from the farms will be converted to methane to generate energy for use in buildings. Rainwater will be collected for irrigation and to replenish groundwater. Hyperion is a sustainable Agriculture project that is resistant to climate change through its healthy ecosystem and environment. (ABIGAIL BEALL FOR MAILONLINE, 2016)

4 Situation of office buildings that have been built in Vietnam at present, Course Goals and Course Outcomes in Teaching office buildings projects applying Urban Agriculture in Vietnam

4.1 Current situation of office buildings in Vietnam at present

Office buildings that are built in big cities in Vietnam currently are mainly high-rise buildings with reinforced concrete structures covered with glass, that use artificial air-conditioning systems. Office buildings consume a large amount of energy in maintaining daily operations for lighting and artificial air-conditioning. Along with that is the large amount of greenhouse gases released into the environment that raises air temperature, and contribute to climate change and environmental pollution.

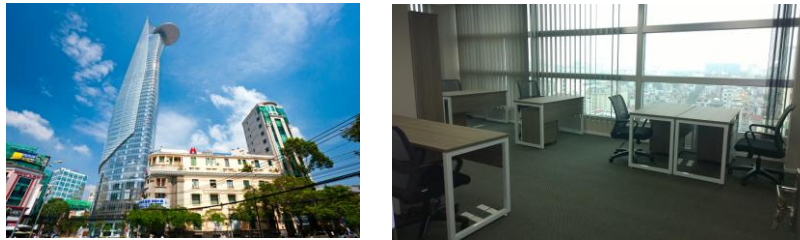

Figure 4: Bitexco Office Building and office interior, Ho Chi Minh City, Vietnam (Bitexco Financial Tower).

Many businesses have also realized the importance of creating a green, clean working environment for employees, so green office models have begun to appear in Hanoi and Ho Chi Minh City (Babylon Landscape, 2018). At the forefront of the green office trend and the application of Urban Agriculture to offices is the Vo Trong Nghia Architecture Company office. With the concept of a "Green" design using light, wind and water, natural materials and local materials, Vo Trong Nghia Architects uses contemporary basic design principles, discovering new ways to create green architecture for the 21st century while maintaining traditional Asian architecture.



Figure 5: Office building and interior of Vo Trong Nghia Architects company (Dezeen Awards, 2019).

Currently the design trend of putting trees into offices is assessed and certified by green building rating standards in Vietnam. The criteria for evaluating green offices in Vietnam include Lotus standards, standards of the Vietnamese Architects Association and Edge standards of IFC of the World Bank Group (Babylon Landscape, 2018). It can be seen that the green office design trend will become indispensable in the future, requiring the training of Architects to master these principles and standards, so that after graduating students can meet the requirements of businesses and society.

4.2 Course Goals

The course includes one theory lesson, with the remained beings project-editing sessions. Students become familiar with the types of green office building architecture. Students grasp the design principles, typical architectural styles of these buildings, master the functional lines and organize the architectural space to ensure optimal operation for an office building. They have to give attention to combining green design solutions and incorporating Urban Agriculture into the building in a reasonable way, without affecting the general function of the building.

4.3 Course Outcomes

- Knowledge: Equip students with the basic knowledge of architectural design methods of office buildings. Provide knowledge of green office building design principles and solutions to bring Urban Agriculture into office building spaces.
- Skills: Students master the design principles and are able to practice in the implementation of green office building design projects, which can be applied for advanced projects at a later stage. Students develop the skills to design high-rise green buildings and incorporate Urban Agriculture solutions into the building.
- Level of autonomy and self-responsibility: Students have the ability to self-study, self-research, know how to recognize and solve cases of the project. Students will have to complete the project with reasonable solutions and show these in the A1 drawings.

5 Steps and criteria for evaluating an office building design project using Urban Agriculture

Making a project based on the Case Study: Bring Urban Agriculture into an office building project.



Figure 6: The design process an office building project (Source: Author, 2020).

The project design process is detailed in the following specific steps:

Step 1: Research design tasks. Detecting problems and ideas of incorporating Urban Agriculture into the design.

Step 2: Analyze and assess the site. Find out the site characteristics and research the proposed solutions for the application of Urban Agriculture.

Step 3: Find ideas, solve problems. Propose preliminary plans about functions and shapes, combine to bring Urban Agriculture spaces into the plan. Offer at least 2 options from which to choose and analyze the pros and cons.

Step 4: Develop the chosen option and solve problems in detail. Giving options of building plan and cubes, with reasonable functional spaces of function and area, as well as the specific plans of cubes and technical solutions for the project when applying Urban Agriculture. This is a process that takes a long time and many lessons to complete.

Step 5: Finalize the project: Show the complete project with technical drawings on A1 papers size, with detailed drawings of the plans, elevations, cross sections and perspectives of the project, as well as specific technical solutions for Urban Agriculture spaces in the building.

6 The application solutions of Urban Agriculture in office building project design, proposed in Architectural Teaching in Vietnam

6.1 Solution to use vegetable growing boxes

One solution is the use of concrete-reinforced vegetable boxes on the building facade or wooden boxes placed on shelves to make partitions in the workspace to grow vegetables. This is the simplest and easiest solution. The use of vegetable boxes on the facade should be incorporated in the initial design of the building, with spaces available for vegetable boxes to be placed later.

Vegetable growing boxes solutions for shelves in workspaces can be more flexible, and can be used to add green space to office spaces, or to be included in interior design drawings from beginning. These vegetable boxes are designed as individual modules, so they can be easily replaced if needed.



Figure 7: Vegetable growing boxes in the office (Source: Author, 2020).

6.2 The use of LED lights to grow agricultural plants in workspaces.

Nowadays in office spaces, the light source used is mainly artificial light. To ensure that agricultural plants can live in the environment lacking natural light, we can use LED lights. In agriculture, LED lights are used to cultivate plant varieties, stimulate plant growth, significantly improve plants density, can provide near-lit lighting without creating a thermal effect that damage the plants, improve quality of

agricultural products, help to increase nutritional value, and reduce nitrate concentration in vegetables. (Ngo, 2016)

LED lights are designed above the planting shelves, providing direct lighting to the plants. These lights can also contribute to decorating the office's interior space. LED lights can also be designed to be hung from the ceiling in a large array, to illuminate a large area of planting in the lobby areas, creating a miniature farm in the heart of the city.



Figure 8: Use LED lights to plant agricultural plants in the office spaces (Ngo, 2016).

6.3 Solutions using vegetable growing towers in office spaces

Another solution is using hydroponic vegetable growing towers suitable for office lobby spaces, as a partition between workspaces, or in meeting rooms. Combined with an automatic irrigation system, the hydroponic vegetable tower can become a trees decorative partition, combined with the interior space to make the working environment closer to nature.

These green spaces act as natural air filters help to improve the quality of air in the office. At the same time, this is also a source of fresh, organic foods for office employees' lunches. Every offices' employees can become farmers who take care of the gardens in their workplaces, harvest products and use them. This is also a method to help them reduce stress and relax after working hours.

The post-hydroponic planting model can combine to create tree party walls in large workspaces. A-shaped or horizontal towers hydroponic vegetables are suitable in large spaces that need decoration, such as office halls or meeting rooms.



Figure 9: Green partitions by vegetable posts

(Source: Author, 2020).



Figure 10: A-shaped Hydroponic vegetable towers

(Source: Author, 2020).

6.4 Aquaponics application solutions on office roofs

Aquaponics is the combination of Aquaculture and Hydroponics. Aquaponics uses circulating water from an aquarium to provide nutrients to plants. Nitrifying bacteria convert waste from aquariums into nutrients suitable for plants. Water is also filtered out by plants and supplied to the aquarium. This is a circulatory system that perfectly takes advantage of each other. (Phan, 2017)

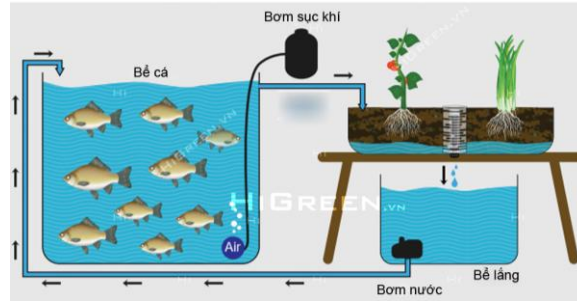

Figure 11: Aquaponics system diagram (Phan, 2017).

There are two methods that can be applied on office buildings rooftops: Aquaponics with shallow irrigation, and shallow water.

In the shallow irrigation method, plants are grown in a tray of terracotta media (depth of about 30cm), at the bottom of the tray, there are holes in the drainage and there is a water breaker. Water from the aquarium through the filter and the pump system is pumped into a vegetable tray. When the amount of water reaches the level of discharge it will be completely discharged to the point where the clean water is disconnected and returned to the aquarium and the process goes on and on. (Aquaponics, 2017)



Figure 12: Aquaponics shallow irrigation method (Aquaponics, 2017).

The shallow water Aquaponics method is suitable for vertical development, with many layers arranged in a small area. This is a method of growing fresh vegetables with a horizontal pipe with shallow water, and nutrients from the aquarium are flowing through the pipe. Vegetables are placed in holes pre-carved at the top of the pipe. (Aquaponics, 2017)

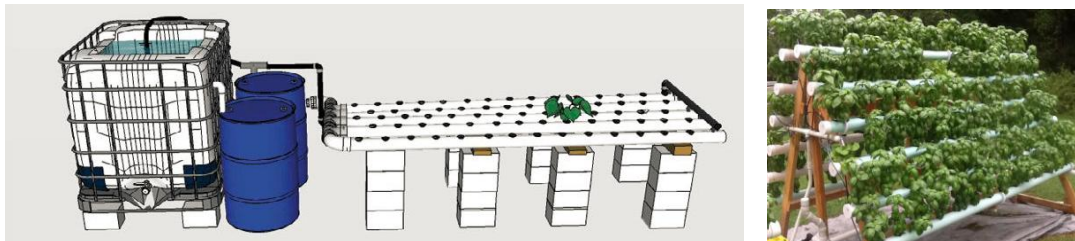

Figure 13: Aquaponics shallow water method (Aquaponics, 2017).

6.5 Use of the T-farm automatic vegetable growing machine

T-Farm is a mini smart garden, designed to be able to grow any type of plants, including leafy vegetables, herbs, coriander, mini fruit trees and medicinal herbs. T-Farm is defined as an indoor garden with all functions automated. We just need to sow the seeds and choose the plants on the app. Watering, nourishing to the plants and lighting help photosynthesis plants be done automatically. (T-Farm, 2019)

Automatic vegetable growing machines are designed as individual modules, so they can be flexibly arranged in different spaces in the office, and change positions as needed. Using a variety of automatic vegetable growing machines designed to suit the general interior space of the office will help increase the green space, beautifying the interior space. The automatic operation mechanism saves care time while still providing the necessary amount of organic vegetables for office employees.



Figure 14: T-farm automatic planting machine (T-Farm, 2019).

7 Conclusion

Society is becoming more modern and developed. Office buildings appear more and more, requiring more office building designs. Green architecture in office building design has been widely applied in the world. Vietnam has also given more attention to green architecture and green office design solutions in recent years. This makes Architects' Teaching to master the principles and standards of green design very necessary in the current period, requiring architectural training universities to try new directions and change project teaching methods. Training should be linked to the reality of business needs as well as the development of society and technology science. The application of Urban Agriculture in green office buildings design is an indispensable trend now, both for creating green spaces in the office and creating a self-sufficient organic fresh food source for people's meals. Therefore, the design solutions that bring Urban Agriculture into the office should become the new design principles and standards when teaching office building design projects for Architectural students.

Urban Agriculture has been contributing greatly to solving difficult problems experienced by countries in the urbanization process. Urban Agriculture will continue to be the solution and strategic direction for the rapid and sustainable development of eco-cities in the future, as well as new training directions for Architectural students. Vietnam is also approaching this model in design as well as training Architects at universities, in order to create a generation of Architects with the capability to designing green and sustainable cities in the future.

References

- Huong-Giang. 2018 (10 March). *Urban agriculture will be an inevitable development trend.* <https://vov.vn/>.
- Luc-Binh. 2018 (24 December). *"Greening" the office: The inevitable trend of the future.* <http://reatimes.vn/>.
- Hong-Nhung. 2018 (04 April). *Unique with the 9-Floors office building growing vegetables in Japan.* <https://tintucvietnam.vn/>
- ABIGAIL BEALL FOR MAILONLINE. 2016 (22 February). *The eco-friendly tower blocks that produce MORE energy than they use: 'Hyperion' designs feature 1,000 homes, gyms and farms.* <https://www.dailymail.co.uk/>.
- Bitexco Financial Tower. www.bitexcofinancialtower.com/.
- Babylon Landscape. 2018. *Solutions for sustainable green office.* <https://canhquanbabylon.vn/>.
- Dezeen awards. 2019. <https://www.dezeen.com/awards/2019/shortlists/vo-trong-nghia-architects/>.
- Ngo, V.Q. 2016 (24 October). *Prospects of LED lighting applications in high-tech agriculture in Vietnam.* <https://anhsangvacuocsong.vn/>.
- Aquaponics. 2017. *Aquaponics vegetable model has 3 methods.* <https://rauxanhcasach.vn/>.
- Phan, L.C. 2017 (05 May). *Chapter 1: Introduction to Aquaponics.* <https://phanlecuong.com/>.
- T-Farm. 2019 (11 May). *What is T-Farm? Why should you own a T-Farm garden?* <https://t-farm.vn/>.
- Greenbot. 2017 (20 September). *How to grow vegetables automatically?* <https://greenbot.vn/>.

Application of the CDIO Standard for teaching the Architectural Composition Subject with a practice competition about green architecture at Ho Chi Minh City University of Technology, Vietnam

First A. Hai-Yen Hoang

Head of Architecture Department, Faculty of Architecture and Art, Ho Chi Minh City University of Technology (HUTECH), 475A Dien Bien Phu Street, 25 Ward, Binh Thanh District, HCMC, Vietnam

hh.yen84@hutech.edu.vn

Abstract

Innovative teaching methods is a matter of great concern to many universities in Vietnam, especially in the context that higher education in the world is changing and requiring higher standards of graduates. To meet the needs of businesses and keep up with the sustainable education standards in the world, universities in Vietnam have to make improvements in teaching methods. CDIO is an international standard system for training engineering students that has been applied in many developed countries around the world. In Vietnam, the Ho Chi Minh City University of Technology (HUTECH) has started to implement this method and this has brought positive results. This article introduces the experience of applying CDIO in university teaching around the world, as well as solutions for applying CDIO in teaching the Architectural Composition Subject for architecture students at the Faculty of Architecture and Art. The end result of this is that second-year students groups will complete a competition for architectural design called: "Feeling the natural beauty in the heart of the city - Finding the natural awakening design solutions" by TOTO Information Center organized, inspired by an architect Takaharu Tezuka from Japan. The purpose of this application is to improve teaching quality, improve the curriculum to help students approach practical architectural competitions, and ensure they can meet the requirements of sustainable design after graduation.

Key words: CDIO, innovating teaching methods, Architectural Composition Subject, green architectural competition, HUTECH, Vietnam.

1 Introduction

At present in the world, the theory of sustainable architecture, green architecture and practical projects under this design model has been included in the architecture curriculum at many universities. Requirements for architectural design in harmony with nature are an inevitable trend because of the need for sustainable development for the global future. In order to keep up with this trend, architects training at Vietnamese universities need to be taught about sustainable design trends from around the world. At the same time, universities in Vietnam are also innovating in teaching methods, changing the curriculum to improve teaching quality, helping students get closer to advanced education, as well as meeting the future requirements of society and business.

“Technical education and the practical needs of engineers in recent years have been increasingly far apart. From the awareness of have to close that wide gap, leading technical universities from the US, Europe, Canada, the United Kingdom, Africa, Asia and New Zealand have jointly created the CDIO Initiative: globally collaborative effort to launch ideas and develop a new vision about technical education.” (Duong, 2015)

CDIO standards have been researched, applied and verified to achieve positive results for students after graduation. CDIO is now considered as a new initiative for education, a methods system, forms of accumulating knowledge and skills in improving the quality of higher education to meet the requirements of businesses and society. As part of taking the first steps in the application of CDIO model in teaching architecture students, the Faculty of Architecture and Art of HUTECH University is gradually applying CDIO to teach some subjects including theory and practice. The Architectural Composition Subject was chosen to apply the CDIO standard to teach the second-year architecture students to approach the sustainable architectural theory design and apply it to do an exam for realistic green architecture competition.

1.1 Concept of CDIO

CDIO, which stands for Conceive - Design - Implement - Operate, originated from the Massachusetts Institute of Technology (USA). Up to now, this model has been applied more and more by universities and colleges around the world. In essence, CDIO is a solution to improve training quality, meeting social requirements on the basis of determining outcome standards, from which to design training programs and plans. This process is formulated scientifically and logically, and can be applied to many different training areas. (NEWS, 2018)

1.2 Architectural Composition Subject

Architectural Composition is a subject with the objective of providing a general and basic knowledge of architectural definition, the nature of architectural creativity, concepts of form, architectural language, and basic components of the architecture such as the point, line, area, cube, space, time, the theory of architectural combination, rhyme, scale system, proportion, and problems about methodological and creative thinking. (Hai-Yen, 2019, *Architectural Composition Book*)

2 Research Methodology

This paper is a qualitative research, using a mixed method including the data synthesis method, statistical method, survey method and expert method. The data synthesis method is used to analyze and assess the situation of teaching at the current architecture training universities in Vietnam, evaluate the suitability of the current training program compared to the outcome standards requirements of businesses. The statistical method is applied to reference experience of CDIO application in the world with certain effects. The survey method is used to examine the quality of current students, to survey the feedback of businesses on the quality of graduates and the businesses requirements for students. The expert method is used to synthesize standards in the application of the CDIO model.

3 Experience of CDIO application in the world

3.1 American Experience (Massachusetts Institute of Technology)

The CDIO Initiative was pioneered by the Massachusetts Institute of Technology (MIT), to address the gap between industry needs and the quality of engineering graduates being produced (Taylor’s University, *CDIO Initiative*). Immediately after the first five years of implementation (2000-2005), MIT has realized the remarkable achievements that CDIO brings to its training programs: the skills that are focused on the CDIO program are in accordance with the requirements of research institutes and businesses, students are satisfied with the "design-build experience" and a deeper understanding of technical principles, lecturers use a variety of teaching methods and assessment methods, the quantity of people who are participating in the CDIO program is increasing and quantity of people who fail the exam is significantly decreasing. (Massachusetts Institute of Technology *el al.*, 2000)

3.2 Situation of CDIO application in universities in the world today

At present, universities around the world are increasingly applying the CDIO model and its advantages and effectiveness have been confirmed and verified over time in many different universities. As of now, the CDIO program has expanded to more than 50 universities in 25 countries. The countries that have CDIO-applying universities are the United States (University of California Daniel Webster, Massachusetts Institute of Technology, Naval Academy), Canada (Royal University, Ontario, Calgary, Manitoba, ...), France (Telecom Bretagne), New Zealand (University of Auckland), the United Kingdom (Lancaster University, Liverpool, Leeds, Aston and Royal University of Belfast-Northern Ireland), Sweden (Chalmers University of Technology, Jnkping, Linkping , ...), Finland (University of Applied Sciences), South Africa (University of Pretoria), Portugal (Advanced Institute of Engenharia do Porto), Singapore (Polytechnic University). (Vo, 2011)

4 Scientific basis of the application CDIO in training engineering students

4.1 CDIO nature

CDIO is a system of methods to develop engineering students training programs, but this is essentially an outcome-based training process outcome-based to design income standards. This process is built to ensure scientific and rigorous practicality.

Table 1: Intended CDIO Outcomes (Karl-Frederik *el al.*,2003).

	Curriculum	Teaching and Learning	Laboratories and Workshops	Assessment
Programme	Models for curriculum structure and design.	Understanding and addressing barriers to student learning.	Models for the design and use of laboratories/workshops.	Tools and processes for programme evaluation.
Student Experience	Curricular materials for CDIO education.	Active and experiential learning with enhanced	Workshop-based educational experiences.	Tools and processes for assessing student

		feedback.		achievement.
--	--	-----------	--	--------------

Following the CDIO approach, students will learn individual skills, communication skills, product creation skills, process and system building along with specialized knowledge in specialized practice training programs. It is integrated learning. Integrated learning has the advantage of allowing students to use the dual time to both learn knowledge and learn specialized application skills.

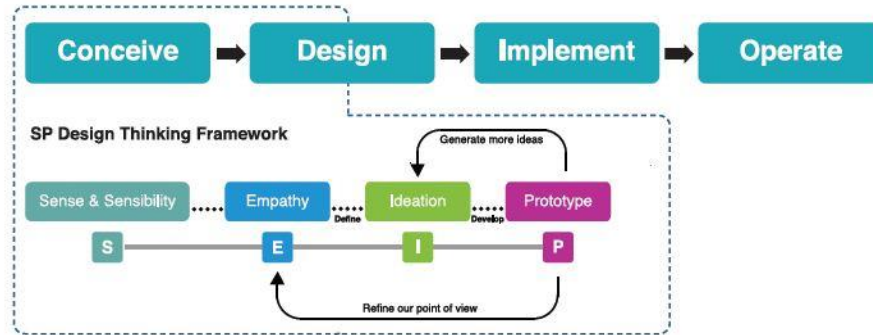

Figure 1: Steps to proceed with CDIO (APC, 2019).

CDIO model training helps to connect students' ability to work with the requirements of employers, helping learners develop comprehensively with "hard skills" and "soft skills" to quickly adapt to an ever-changing working environment and even be at the forefront of that change. Helping training programs are built and designed according to a standard process. The training processes are connected and closely linked with science, linking the development of training programs with the transmission and evaluation of the effectiveness of higher education, and contributing to improve the quality of higher education.

4.2 CDIO standards

- 1 - **The Context:** Adoption of the principle that product, process, and system lifecycle development and deployment Conceiving-Designing-Implementing-Operating — are the context for engineering education.
- 2 - **Learning Outcomes:** Specific, detailed learning outcomes for personal and interpersonal skills; and product, process, and system building skills, as well as disciplinary knowledge, consistent with program goals and validated by program stakeholders.
- 3 - **Integrated Curriculum:** A curriculum designed with mutually supporting disciplinary courses, with an explicit plan to integrate personal and interpersonal skills; and product, process, and system building skills.
- 4 - **Introduction to Engineering:** An introductory course that provides the framework for engineering practice in product, process, and system building, and introduces essential personal and interpersonal skills.
- 5 - **Design-Implement Experiences:** A curriculum that includes two or more design-implement experiences, including one at a basic level and one at an advanced level.
- 6 - **Engineering Workspaces:** Engineering workspaces and laboratories that support and encourage hands-on learning of product, process, and system building, disciplinary knowledge, and social learning.

7 - **Integrated Learning Experiences:** Integrated learning experiences that lead to the acquisition of disciplinary knowledge, as well as personal and interpersonal skills; and product, process, and system building skills.

8 - **Active Learning:** Teaching and learning based on active and experiential learning methods.

9 - **Enhancement of Faculty Competence:** Actions that enhance faculty competence in personal and interpersonal skills; and product, process, and system building skills.

10 - **Enhancement of Faculty Teaching Competence:** Actions that enhance faculty competence in providing integrated learning experiences, in using active experiential learning methods, and in assessing student learning.

11 - **Learning Assessment:** Assessment of student learning in personal and interpersonal skills; and product, process, and system building skills, as well as in disciplinary knowledge.

12 - **Program Evaluation:** A system that evaluates programs against these standards, and provides feedback to students, faculty, and other stakeholders for the purposes of continuous improvement. (Edward *et al.*, 2007)

4.3 Teaching level and competency level

Teaching level: I (Introduce); T (Teach); U (Utilize).

Competency level: 1: Knowing or experiencing; 2: Can participate in and contribute; 3: Can understand and explain; 4: Have practical skills or implementation; 5: Can lead or be creative.

5 Ability to apply CDIO in training engineering students in Vietnam and HUTECH University

In Vietnam, the application of CDIO is initially being tested. Beginning in the 2009-2010 school years, Hanoi National University and HCMC National University started to apply CDIO to train some majors at its member schools. According to a report at the Asian CDIO Conference at the end of March 2015, after more than five years of implementation, HCMC National University has implemented the reform of 45 training programs under CDIO approach. The greatest achievement, as judged by CDIO implementation experts here, is that the lecturers have been greatly improved. The first students that graduated are full of hope as a result of the CDIO implementation. (Duong, 2015)

Since then, the application of CDIO has been expanded to many universities in Vietnam as a solution in improving training programs and improving the quality of higher education. Aiming towards an application-oriented higher education model, HUTECH University has applied the main methods in the CDIO model such as integrated teaching and learning methods, active learning in the curriculum and achieved positive results.

The CDIO approach requires that some basic conditions: facilities, lecturers, staff, training programs, and students meet the basic standards of CDIO. In order to apply the CDIO training program, universities have to review and reconstruct the training program and outcome standards. Lecturers need to be trained to suit the curriculum, as the amount of teaching work, and assessment increases for each lesson. Students

need a lot of practice so the quantity of exercises and projects increases. In addition, the budget for developing training programs with CDIO standards is very large. With private university such as HUTECH, the quantity of students in a class is very large, while the quantity of lecturers is small, which is also a challenge in the process of applying CDIO standards in teaching.

6 Application of CDIO to teach the Architectural Composition Subject at HUTECH University

6.1 Course Goals

Equip architecture students with certain knowledge about architectural creation, aesthetics and architectural design. As a precursor to help students in-depth study in the field of architecture of civil engineering, planning, industry and urban management.

6.2 Course Outcomes

Table 2: Course Outcomes standards of Architectural Composition Subject (Hai-Yen, 2019, *Architectural Composition Outline*).

Course Outcomes	Teaching Level
Knowledge: - CO1: Understand, apply and practice the specialized basic knowledge in designing and shaping architectural. Understand the method of architectural creation.	I2, TU2
Skill: - CO2: Understand and apply the basic knowledge of architectural creation skills. - CO3: Willing to accept new trends in a positive, non-conservative way.	TU2
Autonomy, self-responsibility: - CO4: Ability to work in groups. - CO5: Ability to analyze and apply the principles and rules of architectural design, in making academic conclusions. - CO6: Having capacity to manage and promote collective intelligence in the implementation of architectural design projects.	TU2

6.3 Teaching methods

Use a combination of methods: Case Stud based learning; Put theoretical knowledge into practice, promote the ability to think creatively, generalize; Study based on discussion and teamwork; Evaluate feedback between student groups and the lecturer.

Table 3: Methods of Teaching Architectural Composition Subject (Hai-Yen, 2019, *Architectural Composition Outline*).

Methods	Goals
Learning theory	Provide students with the basic knowledge of the subject through direct classroom lectures.
Presentation	Provide students with the basic knowledge system of the subject in a scientific and logical way through homework and presentations.
Discuss	Through Questions & Answers between teachers and students, between students to clarify the content knowledge in the subject.
Exercises	Help students understand and apply subject content into practical issues.
Study the lessons, read the references	Help students strengthen self-study and self-research capacity. Raise excitement for students in order to find the way to resolve the problem.

6.4 Level of meeting the standards of CDIO in Teaching Architectural Composition Subject

Table 4: Level of meeting C-D-I-O standards (Source: Author, 2020).

The Content	Meet CDIO standards	Meet Course Outcomes
Students learn the theory in parallel with the practice, development and deployment of architectural design products according to processes and systems: forming ideas, designing and implementing.	Standard 1	CO1, CO2, CO3
Specific outcome standards with communication skills when working in groups, presenting concepts, product creation skills, professional knowledge fit with the Architectural Composition Subject.	Standard 2	CO1, CO2, CO3, CO4, CO5, CO6
Integrated training program, integrating personal and communication skills, product creation skills to complete the exam with standard technical drawings and models.	Standard 3, 4	CO1, CO2, CO4, CO5, CO6
Students experience the design and implementation according to the theme of the competition from idea to product, and work in an architectural practice workshop.	Standard 5, 6	CO2, CO3, CO4
Students take proactive approach in studying. To do the competition, students need to actively learn more specialized knowledge and learn about competitions subject to create the right product. When students need further information and advice, they have the help from a lecturer.	Standard 7, 8	CO2, CO3
When students join the national architectural competition, the lecturer also needs to learn more about the requirements of the competition, as well as modern architectural trends to advise students. In addition, the lecturer is also an inspirational person to help students be more motivated to do the competition.	Standard 9, 10	CO1, CO2, CO3

Assess the learning results of the subject with a complete submission including drawings and models. Students present in class, then submissions are sent to the evaluation company. There are small architectural projects, so it is possible to evaluate the ability to create products as well as specialized knowledge.	Standard 11	CO1, CO2, CO4, CO5, CO6
Subject results are evaluated by lecturer, students and company for the purpose of improving the subject and teaching quality in the future.	Standard 12	CO1, CO2, CO3, CO4, CO5, CO6

6.5 *Comparing the students quality that studying Architectural Composition Subject in CDIO program and usual teaching program*

Architecture students trained through following the CDIO model are able to better meet job requirements after graduation due to training in professional practice skills as well as soft skills from the subjects. Particularly with Architectural Composition Subject, the curriculum according to CDIO will have a significant difference compared to the conventional curriculum. Specifically expressed as follows:

Table 5: Comparing the student quality between usual teaching program and CDIO program (Source: Author, 2020).

The usual teaching program	CDIO program
Teaching theory and assessment with the final exam.	Teaching parallel theory and practice. Assess intertwining in teaching and learning process with practical Architectural competition.
Evaluation to track learning.	Assessment to promote students' ability to find ideas.
The focus is on the right answers.	The focus is on asking questions to find problems and learning from mistakes.
Learning results are assessed indirectly through the exam.	Desired learning outcomes are assessed directly through the process of making projects, communicating, and presenting.
Promote individualism.	Promote teamwork, coordination, support.
Only students are considered learners.	Teachers and students learn together.
Students acquire knowledge passively.	Students learn proactively and confidently in life.
Students have difficulty to approach real- jobs at the industries due to theoretical study only.	Students can easily access the jobs after graduation and communicate well with colleagues because of practical training from the 2nd year.

6.6 *Students practice on the competition "Feeling the natural beauty in the heart of the city - Finding the natural awakening design solutions"*

Purpose – Requirement: The competition "Feeling the natural beauty in the heart of the city - Finding the natural awakening design solutions" was organized by the TOTO Information Center in Vietnam, and

inspired by an architect Takaharu Tezuka, a famous Japanese architect with a philosophy of architecture design inspired by nature this is human centered.

The competition requirement is to design urban spaces intertwined with the element of "living", feeling the natural voice and people in the modern world, where people are bound in artificial spaces. The harmony between nature and people, maintaining the connection between the past, present and future and what is familiar to create the architecture of life is the main purpose of the competition.

Learning based Case Study: Answering the question: "What is the living factor in urban space?"

Implementation process:

With an interesting topic and a design trend close to nature, which is an interesting architectural trend nowadays, the competition has brought excitement to the students. Being integrated into the content of the architectural composition subject helps students to be more excited with the subject when participating in the second year. The content of the competition is also consistent with the lesson "Architecture and nature" in this subject. A class with 30 students is divided into groups, with 2-3 students per group.



Figure 2: C-D-I-O process to do competition (Source: Author, 2020).

The order of groups to perform this competition in 5 steps is as follows:

Step 1: Problem detection: Research design tasks from competition requirements.

Step 2: Clarify the problem: Answer the question: "What is the living factor in architectural space?". Determining the type of buildings and the design area. Students can choose a small space to renovate or design a new building. Find references related to the selected building type, the design trend of Takaharu Tezuka Architect and the current of the selected site.

Step 3: Innovative solutions: Analyze the land and give preliminary ideas with 2-3 options. Students discuss in groups, compare the proposed solutions with the initial goals of the project, then find out the advantages and disadvantages of each option, which is the basis for making a selection option.

Step 4: Evaluate the solutions: The groups presented the first time about the given options. Based on the analysis of the group with the review of lecturer and the other student groups, provide the choice option.

Step 5: Implement and design the project: Students revise their projects through each session with the lecturer to complete the project. Students show their design ideas in the form of technical drawings including plans, elevations, cross sections and technical solutions on A1-sized papers, with a model. Student groups will present the final option with evaluation from lecturer and other student groups.

In the implementation process always compare with the original goals of the competition in step 1,2. Implement the Backward Design process. The project results obtained at each stage are compared with the original goals to ensure that the designs meet the requirements of the topic and the groups are on the right track. Always take Case Study as a keyword for the whole process of finding ideas and executing projects.

Evaluation criteria:

- Cross-rating between student groups (30% of the total score): When one group of students gives a presentation, the remaining groups will evaluate and give a cross score. Take the average of the scores of the groups to evaluate this criterion.
- Teacher evaluation on CDIO model (70% of the total score):

Table 6: Evaluation criteria on C-D-I-O standards (Source: Author, 2020).

No	Evaluation criteria	Assessment scale				Meet Course Outcomes
		Fail	Pass	Good	Excellent	
1	Solving Case Study: the "Living" factor in urban space.					CO2, CO3
2	Clearly design ideas, in line with the topic goals.					CO2, CO3
3	Architectural functions, Architectural forms are appropriate.					CO1, CO2
4	Materials used, Technical solution.					CO1, CO2, CO3
5	Sustainability, Green factor.					CO2, CO3
6	Community.					CO2, CO3
7	Feasibility of the projects, Future development direction.					CO4, CO5, CO6
8	The technical drawings are shown in accordance with regulations.					CO1, CO2, CO3
9	Power Point making and presentation skills.					CO4, CO5, CO6
10	Teamwork skill.					CO4, CO5, CO6

After the presentation, students complete the test according to the lecturer’s opinions and send them to TOTO company. At completion, students have completed a design competition from begin to the end, and can make products. Participating in an architectural design competition with 2nd year students is only for practice and experience. Following on from this, students will accumulate more experience for the learning process, work and take part in other competitions later. The meaning of a practical project-based learning process is in the process of students working on the projects and self-learning, developing personal skills, teamwork skills, as well as attitudes when approach new problems, find the way to solve them together. Through teamwork process, students improve themselves and make progress over time. At the end of the project, students come up with a better way to solve the problems than at the start.



Figure 3: Students discuss, work in class (Source: Author, 2019).



Figure 4: Group of students implement the project and correct as instructed by the lecturer (Source: Author, 2019).



Figure 5: Student presentation exam report (Source: Author, 2019).

7 Conclusion

Innovating teaching methods to meet businesses requirements is becoming an urgent need for universities in Vietnam. In the context of globalization, as well as the development of the science and technology revolution 4.0, industry requires engineering, and architecture graduates to have professional practice skills as well as soft skills in communication to meet work requirements. CDIO was born as a breakthrough in engineering training that has been successfully applied in many countries around the world. In Vietnam in general and HUTECH University in particular, they have understood the importance of improving the training program and the positive benefits when applying the CDIO model in higher education, especially in the technical sector.

The Faculty of Architecture and Art is an environment of practical architectural training, with the goal that graduates can meet the needs of businesses right after graduation. With a training program that emphasizes practice and creativity, student autonomy, lecturers are just a guide as well as inspiring career for students like previous colleagues. The introduction of sustainable architecture design, and green architecture competitions such as the competition: "Feeling the natural beauty in the heart of the city - Finding natural awakening design solutions" for students to approach from their first year is a positive direction to help students with skills to find ideas, practice, communicate and create products early, and to catch up with the current trend of sustainable architecture design. This method needs to be researched and integrated into specialized subjects to help develop soft skills and practical knowledge for students after graduation, contributing to closing the gap between the universities and businesses, which is the goal that CDIO set out.

References

Massachusetts Institute of Technology, Chalmers University of Technology, Royal Institute of Technology, and Linköping Institute of Technology. 2000 (10 May). *Improved Engineering Education: Changing the Focus towards Active Learning in a CDIO Context*. Proposal submitted to the Knut and Alice Wallenberg Foundation.

APC. 2019 (31 July). *What is CDIO - the trend of modern teaching*. <http://www.caodangvietmy.edu.vn/>.

NEWS. 2018 (17 April). *CDIO - a new direction for education in the changing time*. <https://baomoi.com/>.

Duong, T.T. 2015 (20 April). University - Business: Maintain a short distance. *Light ray Journal*. <https://news.hoasen.edu.vn/>.

Taylor's University. *CDIO Initiative* . <https://university.taylors.edu.my/>.

Vo, V.T. 2011(August). Approach to CDIO to improve the quality of higher education. *Journal of Education*, **268**, 1- 6.

Edward, F.C., Johan, M., Sören, O., Doris, R.B. 2007. *Rethinking Engineering Education- The CDIO Approach*. Springer Science+ Business Media, LCC, ISBN 978-0-387-38287-6, 35.

Karl-Frederik, B., Doris, B., Edward, F.C., Ingemar, I., William, T.G.L., Johan, M., Sören, O. 2003. CDIO: An international initiative for reforming engineering education. *In: World Transactions on Engineering and Technology Education, Vol.2, No.1*.

Hai-Yen, H. 2019. *Architectural Composition Book*. HUTECH University, Vietnam, 3-4.

Hai-Yen, H. 2019. *Architectural Composition Outline*. HUTECH University, Vietnam.

Developing Inclusive and Sustainable Curriculum for Environmental Engineering Courses

Kausar Jahan¹, Sarah Bauer¹, Jagadish Torlapati¹, and Tiago Forin²

¹Civil & Environmental Engineering, Rowan University, Glassboro, New Jersey, USA

²ExEED, College of Engineering, Rowan University, Glassboro, New Jersey, USA

Abstract

Inclusivity and sustainability are becoming integral to the successful delivery of engineering course content. Teaching strategies that incorporate both are gaining momentum globally for engineering educators. Inclusive teaching strategies are based on making all students in the classroom feel valued and equal contributors. Strategies are based on developing curricular material that addresses students from a diverse background (socioeconomic status, race, gender, ethnicity, preferred orientation) and varying learning abilities. Research has shown that inclusive teaching strategies allow instructors to engage and bond with their students and the students bond with the course content. ABET, the accreditation arm for engineering programs has also identified that student outcomes address engineering design that integrates sustainability, ethics and the impact of engineering solutions in a global context. As such engineering educators are challenged to integrate all these concepts in courses that have a finite time for delivery of technical core content.

The Civil and Environmental Engineering department at Rowan University initiated an effort titled "Sustainability Across the Curriculum" in 2008. The department received NSF RED funding in 2017 for a grant titled "*Revolutionizing Engineering Diversity (RevED)*". The goal of this project is to revolutionize the Civil and Environmental Engineering (CEE) Department by radically increasing diversity and retention of women and Underrepresented Minority (URM) students and historically underserved groups. There are five major objectives of this grant:

1. Revise admissions criteria
2. Provide D&I (Diversity & Inclusivity) training to faculty and administrators
3. ***Integrate D&I concepts in core civil engineering courses***
4. Mentoring programs to help retain students
5. Expose role models from industry/academia

This paper addresses the changes made to Fluid Mechanics, Water Resources Engineering, Sustainable Civil and Environmental Engineering and Environmental Engineering (Water and Wastewater Treatment & Design) courses to integrate inclusive content that also focused on sustainability, global, ethical, social and racial injustices. Each course was assessed at the end of each semester to evaluate the impact of the changes on the course. Our Spring 2019 and Fall 2019 course assessments are extremely promising. Students in focus groups were also included for feedback. The assessment tools indicate that the courses are covering the concepts well.

1 Introduction

1.1 Engineering Curriculum

Diversity and inclusivity (D&I) have gained momentum in engineering education and professional practice [Riley et al., 2006; Riley and Claris, 2006]. The lack of diversity in STEM fields still remains of concern today [Peixoto, A., et al, 2018; Philips, K., 2014]. One key factor that has been identified as the reason for the lack of diversity is that engineering educators use teaching pedagogy that is unappealing to students from various diverse backgrounds. This can lead to a chilly unwelcoming climate in their classrooms. Faculty may be unaware that their teaching content may contribute to the departure of students in STEM fields [Beasley and Fischer, 2012; Farrell and Minerick, 2018; Harriet et al., 2019].

As such many researchers [Delaine et al., 2015; Farrell et al., 2017; Riley and Claris, 2003] have advised engineering educators to revise their teaching pedagogy that is attractive to diverse groups and reflects inclusive practices. Institutions globally are now invested in promoting better dialogues, provide mentoring opportunities and train educators to attract and retain students who not only meet the definitions of URMs (Under Represented Minorities) but also represent other vulnerable/historically underserved groups such as first generation, low socio-economic status and other undisclosed groups.

1.2 NSF RED Grants

The National Science Foundation introduced the RED (Revolutionizing Engineering Departments) program to build upon previous efforts in engineering education research. The NSF RED grants were introduced specifically to revolutionize approaches and strategies for transforming undergraduate engineering education. Strategies and approaches that involved changes in cultural, organizational, structural and pedagogical changes. The first RED awards were made official in 2016.

1.3 Civil and Environmental Engineering Curriculum

The Civil and Environmental Engineering department at Rowan University is the first recipient of an NSF RED award. Our NSF RED grant is titled "*Revolutionizing Engineering Diversity (RevED)*". The major goal of this project is to revolutionize the Civil and Environmental Engineering (CEE) Department by radically increasing diversity and achieve high retention and graduation rates of all CEE students. A multi-pronged approach has been undertaken to meet this bold goal. The five steps taken to ensure this are:

1. Revise admissions criteria

2. Provide D&I (Diversity & Inclusivity) training to faculty and administrators
3. ***Integrate D&I concepts in core civil engineering courses***
4. Mentoring programs to help retain students
5. Expose role models from industry/academia

Many publications have reported on these multi-step initiatives and their success/challenges in implementation [Hartman et al., 2018; Forin et al., 2018a,b; Ingram et al., 2017; Sukumaran et al., 2017]. As part of the NSF RevED grant, all core civil engineering courses were identified for curricular content reform. Table 1 presents all the courses that were part of this initiative.

Table 1: Civil Engineering Core Course Selected for D&I Content Revision

Sophomore Year (4)	Statics	Solid Mechanics	Civil Engineering Systems	Surveying
Junior Year (10)	Structural Analyses	Analyses & Design of Steel Frames*	Fluid Mechanics*	Water Resources Engineering*
	Material Science	Civil Engineering Materials*	Geotechnical Engineering*	Transportation Engineering
	Environmental Engineering*	Sustainable Civil and Environmental Engineering		
<i>*courses with lab Courses in bold identified for this paper</i>				

This paper specifically focuses on four select courses: Fluid Mechanics (2 cr), Water Resources Engineering (3 cr), Environmental Engineering (3 cr) and Sustainable Civil and Environmental Engineering SCEE (3 cr), that were identified and incorporated changes in curricular content to include diverse, inclusive content that also integrated ethics, on sustainability, global, ethical, social and racial injustices. All four courses are required to be taken by students in their junior year.

2 Project Implementation

A number of measures were taken by the department to ensure successful faculty buy-in, content development, implementation of course content and the assessment of the courses. Four steps were taken to ensure the success of course content development and implementation. These are presented in Figure 1.

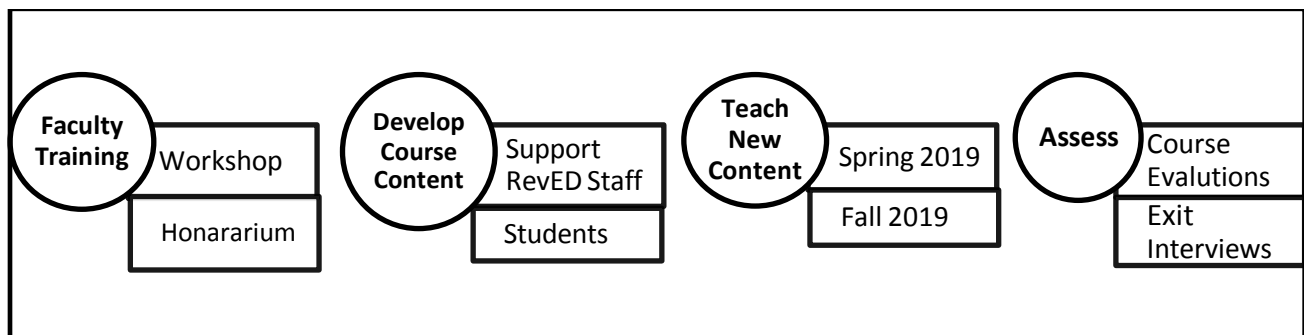

Figure 1: Course Revision Implementation Steps

2.1 Faculty Training and Course Development

An all day workshop was arranged for the faculty to learn the meaning of inclusive curriculum and practice developing inclusive language for their course syllabi, learning objectives, problem wording, assignments and lecture examples. Julia M. Williams and Ella Lee Ingram from Rose-Hulman Institute of Technology conducted this workshop. Faculty were paid a small summer honorarium to invest their time in this endeavour. During the Spring 2018 and Fall 2018 semesters, faculty were also supported by the RevED coordinator and a group of undergraduate students to assist with the development of curricular materials.

2.2 Implementation and Assessment of the Courses

The four courses mentioned earlier, were offered with the new content in the Spring and Fall of 2019. Changes to the course included the following:

- Syllabus Rewording
- Reword technical problem wording
- PowerPoint Presentations on case studies
- Assign a team project (report, presentation, video, brochure)
- Assign team names based on people of influence or the team adopts a country
- Assign teams to watch a movie that focuses on diversity, social injustices, ethic violations, gender biases
- Add questions on quizzes/exams
- Test students in different ways (Take home, Team assignment, Open book)
- Field Trip
- Extra credit- Diversity issues
- Extra Credit- Appreciation for the arts from various cultures

The first four strategies are required for all courses. The four courses identified for this paper used all the strategies identified above. These strategies are described on our RevED website in details for each course [NSF RevED]. Examples for the inclusive course content in the Environmental Engineering and Sustainable Civil and Environmental Engineering, Water Resources engineering courses are presented in Figure 2.

Using a Global example

Ask students in Water Resources Engineering to determine how the waterworks were constructed in the Al-Hambra Palace in Granada Spain. Students learn about the Sierra Nevada Mountains, the Moor civilization, the Nasrid Scholars and their contributions to science and technology.





MOVIES

Assign teams to watch a movie/documentary-not all need to be on a technical contribution.

- **Legally Blonde**- Good message- you can be blonde, beautiful and like pink and be smart!
- **Whale Rider** – Society wants women to prove themselves before they can be picked as a leader
- **Rosalind Franklin: The Dark Lady of DNA**- struggled with lack of confidence-a very human trait in our students
- **Stephanie Kwolek** – Confident about her knowledge
- **Bhopal Express** – How India forced Union Carbide to change laws in the USA for People Right to Know!
- **Erin Brockovich** – Her curiosity and compassion led to justice and the largest class action law suit. Still an activist to this day
- **A Civil Action** – John Travolta; movie based on real case
- **The Imitation Game**- Life of Alan Turing











TEAM NAMES

- Assign teams a name of a person of influence or the team adopts a country. Use examples that are global and a learning opportunity for the students. **Not every person assigned has to be a scientist or engineer. Have the team use the name throughout the semester.** Present for 2 minutes about the assigned person every other week.
- **Example- Henrietta Lacks, Ruth Bader Ginsburg, Nelson Mandela, Queen Victoria (major scientific contributions made during her reign), Vandana Shiva, Arundhati Roy, F. R. Khan etc**

Rewording a Problem

- Design a batch reactor with ...> *A developing community needs to have access to safe drinking water. A batch reactor will serve their needs.*
- Calculate the alum dose> Alum is an universal coagulant and is used extensively in poor and developing communities. Calculate the alum dose

Syllabus Wording: Inclusive Learning Environment

It is my intention that students from all backgrounds and perspectives will be well served by this course, and that the diversity that students bring to this class will be viewed as an asset. I welcome individuals of all ages, backgrounds, beliefs, ethnicities, genders, gender identities, gender expressions, national origins, religious affiliations, sexual orientations, ability and other visible and nonvisible differences. All members of this class are expected to contribute to a respectful, welcoming and inclusive environment for every other member of the class. If you feel that your contribution is not being valued for any reason, please speak with me privately.

Figure 2: Examples of inclusive measures taken for civil engineering courses [Jahan et al., 2018]

The assessment tool used for evaluating the impact of the curricular content change is presented in Figure 3.

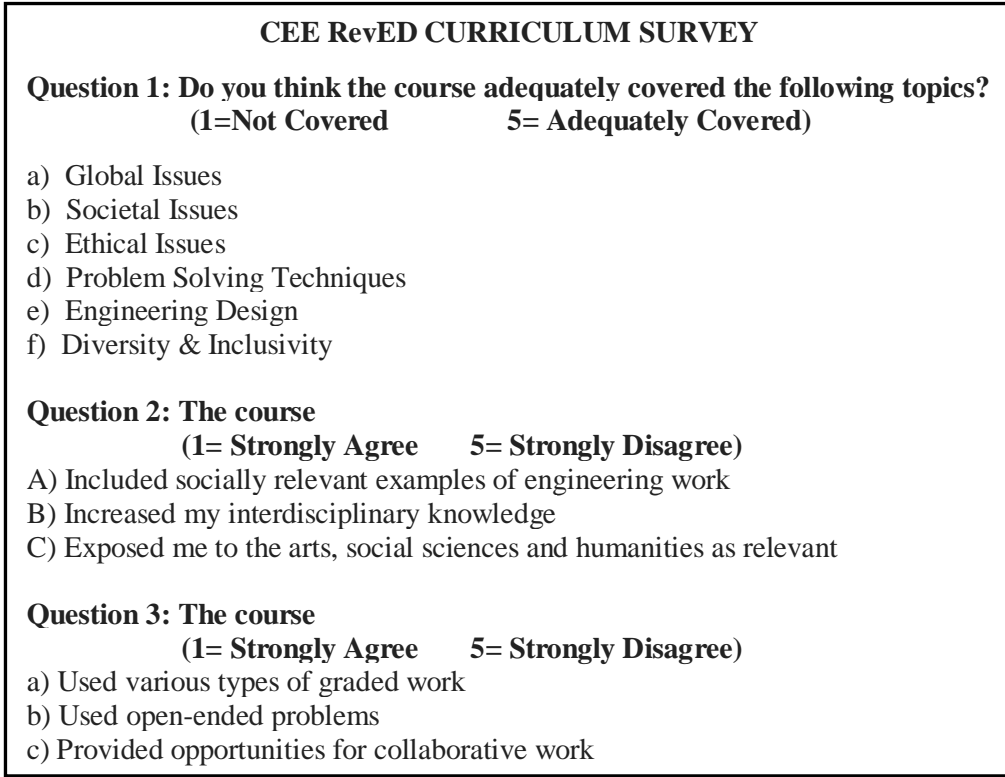

Figure 3: Survey Questions for Course Evaluation

3 Results

The results of the survey are presented in Figure 4 a,b and c. For all questions, 75% or more students

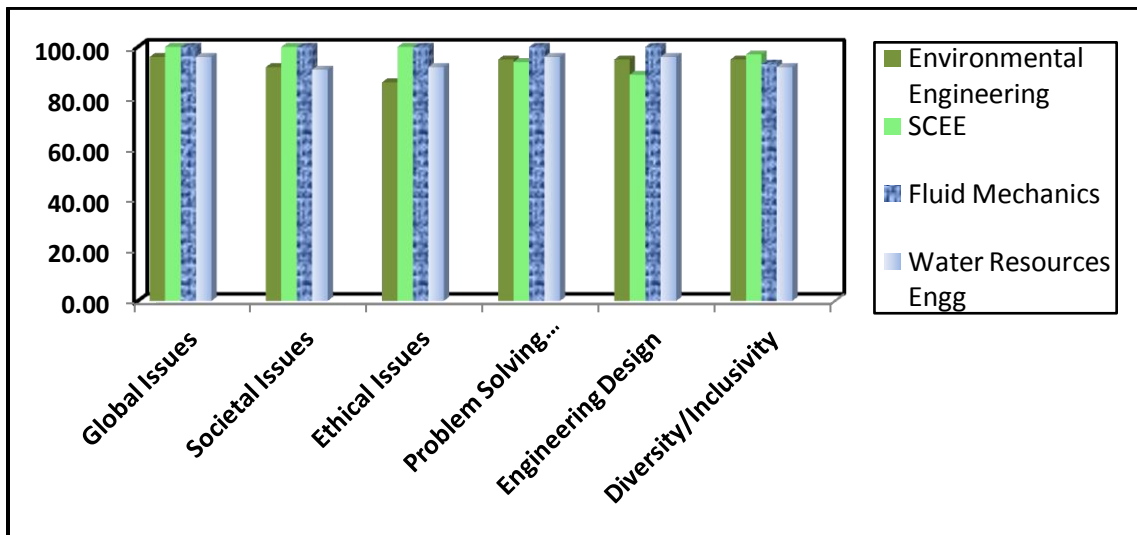

Figure 4 (a): Results for the 4 courses for Question 1

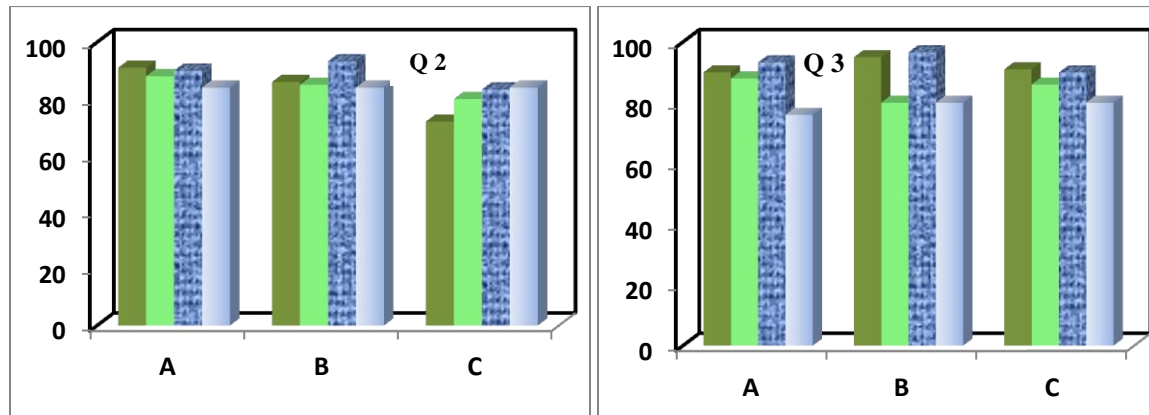

Figure 4 (b,c): Results for the 4 courses for Question 2 and 3

responded favourably to the questions posed about whether the courses were adequately covering concepts that were at the core of the changes in curricular content. These are very encouraging as the courses content were implemented and assessed for the first time. Exit interviews with graduating seniors in Spring 2019 were also positive. All 66 graduating seniors indicated that the courses were interesting, engaging and exposed them to engineering practices that allowed addressing sustainability in a global, social context. The challenges posed are training adjunct and temporary faculty about these changes. Students also complained about survey fatigue as they had to take the same survey for multiple courses.

4 Conclusions

This paper has described how courses in the civil engineering curriculum were revised to integrate inclusive curriculum that also focuses on sustainability, ethics, social, global and racial content. Faculty have to continuously improve their course content and delivery to ensure successful inclusive strategies. While the initial course assessments are very encouraging, challenges will remain in constantly keeping faculty invested in updating the course content.

5 Acknowledgements

We appreciate the support of many undergraduate students who assisted in developing the course content, presentation slides and rewording of problems. This material is based upon work supported by the National Science Foundation under IUSE/PFE:RED Grant No. 1623053 and NSF IUSE 1610164. Any opinions, findings, and conclusions or recommendations expressed in this material are those of the author(s) and do not necessarily reflect the views of the National Science Foundation.

6 References

Beasley, M. A., and M. J. Fischer. 2012. "Why they leave: The impact of stereotype threat on the attention of women and minorities from science, math and engineering majors." *Social Psychol. Educ. Int. J.* 15 (4): 427–448. <https://doi.org/10.1007/s11218-012-9185-3>.

Delaine, D. A., Tull, R. G., & Williams, D. (2015, Sept). Global Diversity in Engineering Education—An Exploratory Analysis. Proceedings of World Engineering Education Forum/International Conference on Interactive Collaborative Learning, Florence, Italy.

Farrell, S., and A. R. Minerick. "The stealth of implicit bias in chemical engineering education, its threat to diversity, and what professors can do to promote an inclusive future," *Chemical Engineering Education*, v.52, 2018, p. 129.

Forin, T., B. Sukumaran, S. Farrell, H. Hartman, K. Jahan, R. Dusseau, P. Bhavsar, J. Hand, & T. Bruckerhoff, "Rethinking Engineering Diversity, Transforming Engineering Diversity," ASEE Annual Conference & Exposition, June 24-28, 2017, Columbus, Ohio. American Society for Engineering Education, 2017.

Forin, Tiago R, Beena Sukumaran, Stephanie Farrell, Kauser Jahan, Theresa Bruckerhoff and Stephanie Lezotte. "Revolutionizing Engineering Diversity," *Annual ASEE Conference, Salt Lake City, Utah.*, 2018.

Hartman et al (2019) First-Generation College Students and Othering in Undergraduate Engineering. ASEE Annual Conference & Exposition, June 24-28, 2019, Tampa, Florida. American Society for Engineering Education.

Hartman, H., Sukumaran, B., Forin, T., Farrell, S., Bhavsar, P., Jahan, K., Dusseau, R., Bruckerhoff, T. "Strategies for Improving Diversity and Inclusion in an Engineering Department," *Journal of Professional Issues in Engineering Education and Practice*, 2018.

Ingram, E. L. (2016, October). Changing your department: examples from revolutionizing engineering departments. Paper presented at 2016 IEEE Frontiers in Education Conference, Erie, PA.

Ingram, E. L., Litzler, E., Margherio, C., & Williams, J. M. (2017). Learning to make change by revolutionizing departments: initial team experiences. 2017 ASEE Annual Conference & Exposition, Columbus, OH.

Jahan, K., C. Bodnar, S. Farrell, Y. Tang, I. Noshadi, CS Slater DS Miller (2019) Improving Students' Learning Behaviors through Hands-on Algae Based Project, *Intl.Journal Engg Education*, Vol 35, No. 5, Pages 1343-1352.

Peixoto, A., et al., (2018) Diversity and inclusion in engineering education: Looking through the gender question, 2018 IEEE Global Engineering Education Conference (EDUCON), 17-20 April, Tenerife, Spain.

Reason, R. D., B. E. Cox, B. R. L. Quaye, and P. T. Terenzini, "Faculty and institutional factors that promote student encounters with difference in first-year courses.," *Review of Higher Education*, vol. 33, pp. 391-414, 2010.

NSF RevED, <https://research.rowan.edu/research-areas/engineering/reved/curriculum/index.html>

Riley, D. M. and L. Claris (2003), "Pedagogies of liberation in an engineering thermodynamics class," ASEE Annual Conference and Exposition, June 22-25, 2003, Nashville, Tennessee. American Society for Engineering Education, 2003.

Riley, D. M. and L. Claris, "From persistence to resistance: pedagogies of liberation for inclusive science and engineering," *International Journal of Gender, Science and Technology*, vol. 1, pp. 36-60, 2009.

Riley, D. M., L. Claris, N. Paul-Schultz, and I. Ngambeki, "Learning/Assessment: A tool for assessing liberative pedagogies in engineering education," in American Society for Engineering Education Annual Conference, 2006.

Sukumaran, B., Forin, T., Hartman, H., Farrell, S., Bhavsar, P., Jahan, K., Dusseau, R., Bruckerhoff, T. (2017) "Rethinking Engineering Diversity, Transforming Engineering Diversity (REDTED)," *ASEE Annual Conference, Columbus, OH, 2017*.

Engineering Mechanics and Sustainable Engineering

Nand K Jha

Professor

Mechanical Engineering Department

Manhattan College, Riverdale, NY 10471

Abstract

At a time of significant global environment challenges and need for sustainable development. A new area of Sustainability in design and manufacturing is on the horizon and Engineering Mechanics Curricula need to equip the graduates with theory, knowledge, and applications of this new science. There has been global dialogue about sustainability but still it is confined to seminars and conferences. This paper endeavor to present framework of diverse discipline and its integration in engineering mechanics curriculum by redesigning and/or reformulating the existing engineering curriculum. There is urgent need for graduates to acquire the knowledge and skills to provide innovative solutions to issues being faced. Engineering profession has a vital role to play in addressing the climate change and helping the society to sustainable development. This reformulation of curricula will also assure accreditation with professional bodies and future engineering enrollment. Therefore, there is need for a lock-p approach to undertaking rapid curriculum redesign and integration of sustainability considerations and principles in mechanical engineering. Thermodynamic concepts are applied in various engineering fields in study of environmental degradation and sustainability. Thus, thermodynamic study is also utilized in ecology, economics and engineering. First and Second Laws of Thermodynamics defines Exergy is viewed as providing the basis of a tool for resources and emission accounting. Engineering education has to reformulate the curriculum so that accreditation with professional bodies is guaranteed. The lack of accreditation will adversely affect in engineering enrollments.

Introduction

The Brundtland UN Commission statement regarding sustainability states, "sustainable development is the development that meets the need of the present generation without compromising the ability of future generation to meet their own needs". It is very broad statement and how far the present generation can meet this challenge of sustainability is open to discussion. However, due to depletion of resources, global warming, water, air, and soil pollution, there is need for rethink for developmental strategies of present generation. One of the most important advances in academic work in recent years has been focus on ecology as social, economic and political category. New ecological consciousness has emerged as a result of the direct assault on the ecosystem by human activity, threatening to obliterate many species, including ourselves. The unsustainable development of global economy, with its insatiable desire for energy, is at the root of ecological crisis.

Engineers are at forefront of development and the concept of sustainability must be taught in schools. Authors believe that curriculum needs to be reformulated and sustainability concept green economy included. The production of goods and services where engineers are at forefront is mainly profit driven rather than one to meet basic human needs for clean water, fresh air, and safe food. It appears as most irrational and inefficient use of earth resources. This study examines the interactions between the functioning of society, ecology, and human well-being globally. The Figures 1 and Figure 2 present the concept graphically and

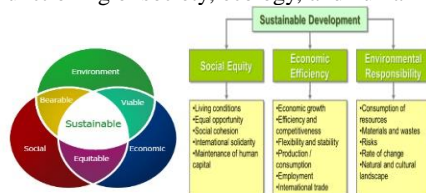

Figure 1. Environment, Economy, and Sustainability Figure 2. Concept of Sustainable Development

Mechanical Engineering curriculum should strive to include it.

Fig.1 shows the practical framework for the use of thermodynamic ideas and analysis in second law in larger concept of environmental sustainability. Fig.2 shows all practical parameters for sustainability underpinned by thermodynamic principles. Engineering education need to emphasize on utilization of resources for needs of society not for making profit. The Engineering Mechanics education should incorporate green technologies or environmentally friendly technologies and energy efficiency in context of sustainability considerations in the curriculum. The concentration on energy and environment, within the

mechanical engineering should prepare students to analyze technical problems in: 1) air pollution, 2) climate change, 3) energy efficiency, 4) environmental sustainability, 5) renewable energy, 6) timely issues facing the global community. The current educational systems perpetuate an unsustainable industrial/ modernist model of development. The companies wish to recruit employees who understand the principles of environmental impact on the society of their decision. Therefore, it is the university task to train and prepare those engineers to accomplish their mission which in turn should be mission of engineering schools. In this the role of Accreditation Board of Engineering and Technology (ABET) is tremendous. Green Design and Manufacturing for Sustainability are a must for engineering curricula and ABE should stress these principles in their recommendation to higher education. This will help achieve the concept of sustainable development as depicted in Fig.2 above. The green engineering integrates the concepts developing green technologies, energy conservation and efficiency, waste reduction or prevention, pollution prevention or elimination, including the health and safety of consumers. We know consumers are now demanding such green products and companies have to include green technologies in their production chain to remain competitive and exist in the global market. We know that many industries are making notable effort to reduce the environmental impacts of their products and services.

1.1 Ecology and Engineering:

Industrial ecology applies the structure and processes of natural ecosystem for organizing activities across several domains of material, energy, environmental quality, and information exchange. The industrial ecology emphasizes the concept of sustainability-which means composite (integrated) development while consuming least resources and minimizing the pollution of land, water, and air. It will reduce global warming and climate change. Sustainability advocates systematic and global approach in order to minimize resources consumption, decarbonizes energy, minimize greenhouse gas (GHG) emissions, and encourage recyclability and reuse of materials. The emphasis on recycling and reuse in production process reduces the need for raw material extraction and waste disposal. It strives to encourage the use of renewable energy with low carbon emissions and GHG. Sustainable engineering integrates green technology in design and manufacturing along with environmental management. In past, we were not concerned with environmental management in engineering education but now energy sustainability emphasizes this part of industrial activity. The ecology of production follows the flow of materials from mining, to end-of-life and we should strive to minimize the negative effects to the environment. The tools for sustainable engineering include life-cycle assessment, material flow analysis, input/output economic models, and indicators for measuring or assessing sustainability. According to ISO 14040 standards, LCA shall include four phases and they are goal and scope definition, inventory analysis, impact assessment, and interpretation of result as shown in figure below.

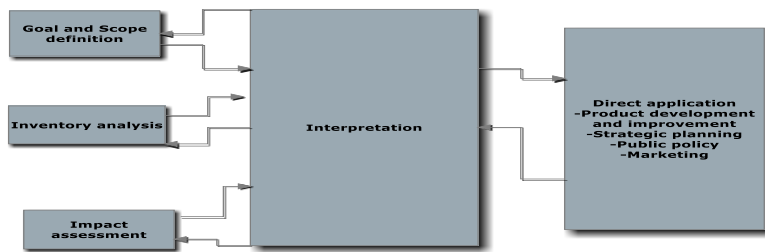

Figure 1: Process Required in Performing an LCA SmartDraw Academic Edition

Figure 3: Life Cycle of a Product

Industry must integrate LCA for systematic evaluation of product design methods. The environmental input-output analysis increasingly plays a role in measuring the economic and environmental effects of sustainable development policies in Europe. Consequently, there is need to merge both approaches to address the calculation of unbiased and consistent carbon dioxide emission multipliers. Now a new policy-relevant application of these multipliers has been introduced for the quantification of the performance of the carbon dioxide emission reductions by industries via external trade. At the heart of industrial ecology is the knowledge of how to reuse or modify and rec This will not only save money for materials and reduce GHG emissions and energy consumption. This will reduce the depletion of resources and extraction from nature and thereby reduction of natural degradation. The goal for mechanical engineers should be to take on design tasks such as managing the recycling and reuse of the product at end of life. The target should be to make more intricately networked and efficient design to disposal activities. The basic principles of industrial ecology may be same for every major field of engineers. However, it may need a little tweaking or modification for different fields of engineering. The most important aspect for industrial ecology is material and energy balancing. Material balances are fundamental to the control of production, particularly in the control of yields of the products. Volume of materials, as they pass through production systems, can be described by the statements of conservation of mass. With every step in the production process such as design, material, rate of production, and equipment, the material balances need to be determined again and again.

The increasing cost of energy has caused the industries to examine means of reducing energy consumption in production. Energy balances are used in the examination of the various stages of a process, over the whole production process and even extending over the total production system from the raw material to the finished and to the disposal.

1.2 Method for Preparing Process Flow Chart

The identification and drawing up a unit operation/process is prerequisite for energy and material balance. The procedure for drawing up the process flow diagrams is illustrative of the production process, involving various input resources, conversion steps and outputs and recycled streams. The process flow may be constructed stepwise i.e., by identifying the inputs/outputs/wastes at each stage of the process. A graphical representation provided in Figure 1.

Process steps should be sequentially drawn from raw material to finished product. Intermediates and any other byproduct should be represented. The operating process parameters such as temperature, pressure, % concentration, etc. should be included.

- Inputs of the process should include raw materials, water, steam, energy (electricity, etc.);
- The flow rate of various streams should also be represented in appropriate units like m^3/h or kg/hr .
- Wastes / by product could include solids, water, chemicals, energy etc. For each process steps (unit operation) as well as for an entire plant, energy and mass balance diagram should be drawn.
- Output of the process is the final product produced in the plant.

Material and energy balances can be very complicated at stages, but the basic approach is straight forward. Experience in working with a single item manufacturing can be extended to more complicated production systems. The increasing use of computers facilitates the mass and energy balance models to be manipulated quite easily and therefore used for production management to maximize production and minimize costs. We should not forget that whole concept of industrial ecology is based on the principle that it must be able to reduce the greenhouse gas (GHG) emissions and reduction in use of energy and materials. Material and Energy balances are important, since they make it possible to identify and quantify previously unknown losses and emissions. These balances are also useful for monitoring the improvements made in an ongoing project, while evaluating cost benefits. Raw materials and energy in any manufacturing activity are not only major cost components but also major sources of environmental pollution. Inefficient use of raw materials and energy in production processes are reflected as wastes.

1.3 Guidance for M&E Balance

- For a complex production stream, it is better to first draft the overall material and energy balance.
- While splitting up total system, choose, simple discrete sub-systems. The process flow diagram could be useful here.
- Choose the material and energy balance envelope such that, the number of streams entering and leaving, is the smallest possible.
- Always choose recycle streams (materials and energy) within the envelope.
- The measurement units may include, time factor or production linkages.
- Consider a full batch as the reference in case of batch operation.
- It is important to include start-up and cleaning operation consumption (of material and energy resources (M&E)).
- Calculate the gas volumes at standard conditions.
- In case of shutdown losses, averaging over long periods may be necessary.
- Highlight losses and emissions (M&E) at part load operation if prevalent.
- For each stream, where applicable, include energy quality (pressure, temperature, enthalpy, (Kcal/hr, kW, Amps, Volts etc.).

The material and energy (M&E) balances should be developed for entire production system and it could also be equipment-wise M&E balance could help assess performance of the equipment, which in turn help identify and quantify energy and material avoidable losses. In manufacturing system problems, it could be of immense help even in designing the equipment itself.

1.4 Steps in Mass and Energy Balance Calculation:

Basically, mass and energy balance calculation checks if directly or indirectly measured energy and mass flows are in agreement with the mass and energy conversion principles. In order to use it correctly, a step by step approach is advocated. Steps can be identified as:

1. Clearly identify the problem to be studied. In case of manufacturing system problems, we have to identify material removal process such as turning, milling, grinding, etc., as every one of them runs on different principles and the mechanics of material removal are quite different.
2. Define a boundary that encloses the complete system or sub-system or the equipment to be analyzed.
3. The enclosing boundary such that measurements is accurate and easy.
4. Select the appropriate test period depending on the type of process and product. Calculate the energy and mass flow based on the measurements in step 3.
5. Check the mass and energy balance. If the balances are outside the acceptable limits, then repeat the measurements.
6. The energy release or use in endothermic and exothermic processes should be considered in the energy balance.

These show the need for increasing energy efficiency, and the potential for exergetic improvement in energy productivity in industry. Poor thermodynamic performance is mostly result of exergy losses in combustion and heat transfer. So, there is need for heat, mass, and energy balance study in thermodynamics. There is no comprehensive curriculum development from undergraduate to graduate study with regard to sustainability. One of the main objective s of our engineering curriculum should be to prepare our graduates who can realize the impacts of technology on environment and develop solutions that minimize

negative impact on environment. The Mechanical Engineering curriculum provides a strong foundation in Thermodynamics, Solid Mechanics, Fluid Mechanics, Heat Transfer and Design. There is urgent need for inclusion sustainability in mechanical engineering curricula. ABET 2010 and 2013 now require graduates should be able to design a system, component or process to meet the desired needs within realistic constraints of economy, environment, society, political, ethical, health and safety, manufacturability, and sustainability. This shows that sustainability considerations must be integrated into engineering curriculum as it has become consumer choice process for products. The implementation of green technology in product development and environmentally conscious manufacturing, energy and efficiency must become integral part of modern sustainable business and therefore, the engineering and technology education.

2. **Basic Principles.** Representing the manufacturing system as a box in the figure below, the mass and energy going into the box must balance with mass and energy coming out.

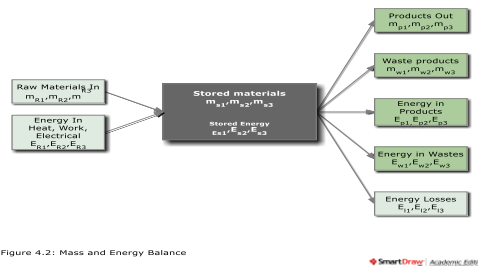

Figure 4.2: Mass and Energy Balance

SmartDraw Academic Edition

Figure 4: Mass and Energy Balance

The law of conservation of mass leads to material balance equation; Mass in = Mass out + Mass stored
Raw Materials = Products + Wastes + Stored Materials

$$\sum m_R = \sum m_p + \sum m_w + \sum m_s \quad (\text{Where } \sum \text{ denotes the sum of all terms}) \quad (1)$$

$$\sum m_R = \sum m_{R1} + \sum m_{R2} + \sum m_{R3} = \text{Total Raw Materials} \quad (2)$$

$$\sum m_p = \sum m_{p1} + \sum m_{p2} + \sum m_{p3} = \text{Total Products} \quad (3)$$

$$\sum m_w = \sum m_{w1} + \sum m_{w2} + \sum m_{w3} = \text{Total Waste Products} \quad (4)$$

$$\sum m_s = \sum m_{s1} + \sum m_{s2} + \sum m_{s3} = \text{Total Stored Products} \quad (5)$$

It is possible that in a manufacturing systems more than one product, i.e., $p = 1, 2, 3, \dots, n$ are being manufactured. The energy input is the embodied energy for separate products and materials. Waste materials in the manufacturing systems (particularly machining) and the chips being created after machining. We need energy during machining and must be included in the energy balance equation. Just as mass follows the law of conservation, so is energy conserved in manufacturing operations. The embodied energy into the operation and the energy used for manufacturing must balance the energy coming out and energy stored.

2.1 Energy Balances

Energy takes many forms such as heat, kinetic energy, chemical energy, potential energy but because of inter-conversions it is not always easy to isolate separate constituents of energy balances. However, under some circumstances certain aspects predominate. Therefore, energy balances tend to focus on particular dominant aspects and so a heat balance, for example, can be useful description of important cost and quality aspects of process situation. Then after some preliminary calculations, the important ones emerge and other minor ones can be lumped together or even ignored without introducing substantial errors. Energy balances can be calculated on the basis of external energy used per kilogram of product, or raw material processed, or on dry solids or some key component. The energy consumed in food production includes *direct energy* which is fuel and electricity used on the farm, and in transport and in factories, and in storage, selling, etc.; and *indirect energy* which is used to actually build that machines, to makes the packaging, to produce the electricity and the oil and so on. In SI system there is only energy unit, the *Joule*. In some heat balance, people still use British Thermal Unit (BTU).

Embodied Energy in + Energy Used in Manufacturing = Energy Out (Embodied Energy in the Products)

$$\sum E_E = \sum E_{e1} + \sum E_{e2} + \sum E_{e3} = \text{Total Embodied Energy} \quad (6)$$

$$\sum E_m = \sum E_{m1} + \sum E_{m2} + \sum E_{m3} = \text{Total Manufacturing Energy} \quad (7)$$

$$\sum E_w = \sum E_{w1} + \sum E_{w2} + \sum E_{w3} = \text{Total Energy Embodied Wasted in Chips} \quad (8)$$

$$\sum E_l = \sum E_{l1} + \sum E_{l2} + \sum E_{l3} = \text{Total energy loss to atmosphere (in form of heat)} \quad (9)$$

$$\sum E_{eo} = \sum E_{eo1} + \sum E_{eo2} + \sum E_{eo3} = \text{Total Embodied Energy out} \quad (10)$$

For the energy balance equations 6 & 7 should be added on the left side of equality and equations 8, 9, & 10 should be on the right side. We can show the complete energy balance equation as

$$\sum E_E + \sum E_m = \sum E_w + \sum E_l + \sum E_{eo} \quad (11)$$

Energy balances are often complicated because forms of energy can be interconnected, but overall the quantities must balance. The thermodynamic analysis of resources used in manufacturing processes is shown below.

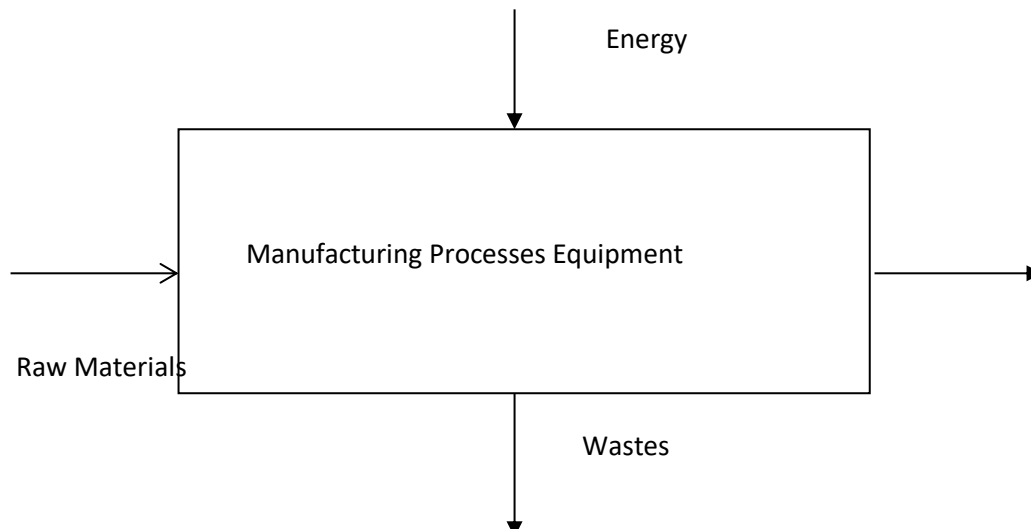

Figure 5: Resources Analysis in Manufacturing Processes

Figure 5 above shows the inputs of raw materials and energy into the manufacturing equipment and outputs of product and wastes. Product is useful part coming out of manufacturing systems and wastes are scrap, chips, and heat. The ecology

2.2 Heat Balances

The most common important energy form is heat energy and the conservation of this can be illustrated by considering operations such as heating and drying. In these, *enthalpy* (total heat) is conserved and as with mass balances so *enthalpy* balances can be presented for various items of equipment or process stages, or round the whole system (plant), and it is assumed that no appreciable heat is converted to other form of energy such as work.

Enthalpy (H) is always referred to some reference level or datum, so that the quantities are relative to this datum. Working out energy balance is then just a matter of considering the various quantities of materials involved, their specific heats, and their changes in temperature or state (as quite frequently latent heats arising from phase changes are encountered). Figure 6 below illustrates the heat balance.

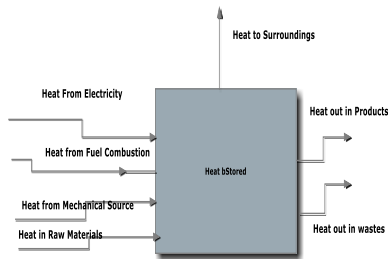

Figure 4.5: Heat Balance

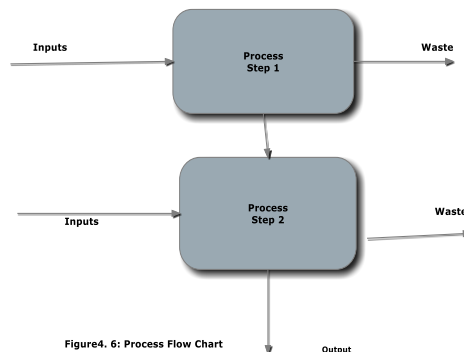

Figure 4.6: Process Flow Chart

Figure 6: Concept of Heat Balance

Heat is absorbed or evolved by some reactions in processing but usually the quantities are small when compared with the other forms of energy entering into the system such as sensible heat and latent heat. Latent heat is the heat required to change, at constant temperature, the physical state of materials from solid to liquid, liquid to gas, or solid to gas. The units of specific heat are J/kg K and sensible heat change is calculated by multiplying the mass by the

specific heat by the change in temperature i.e. $m.c.\Delta T$. The units of latent heat are J/kg and total latent heat change is calculated by multiplying the mass of material, which changes its phase by the latent heat. Having determined these factors that are significant in the overall energy balance, the simplified heat balance can then be used with confidence in energy studies. Sustainable Engineering should be an important part of Mechanical Engineering program to take care of modern interpretation of this rapidly changing field. Unlike the classical environmental engineering topics (e.g. water sanitation, brownfield remediation) many new environmental engineering and sustainability challenges require strong quantitative skills, as taught in mechanical engineering. Renewable energy technologies require skills in material science and physics, climate change research requires individuals trained in fluid mechanics and environmental transport, sustainable building design requires deep knowledge of heat and mass transfer in complex geometries. Mechanical engineers design and solve issues for all kinds of devices, from small toys to large machines that help to run ships, automobiles and generators. Mechanical engineers design many of the parts, pieces and equipment that people use daily. Their jobs may take them from an office environment to a manufacturing plant and to the outdoors to ensure their designs are working properly. The principles of mass balance, energy balance, and heat balance must be included in mechanical engineering curriculum at every step.

3. ABET Requirements of Mechanical Engineering

The Mechanical Engineering Program has a traditional ABET accredited four-year curriculum involving mechanics, vibrations, thermodynamics, fluid flow, heat transfer, materials, control theory, and mechanical design. Graduates of this program are expected to have the following skills, knowledge, and abilities to work professionally in mechanical system areas including design and realization of such areas.

New requirements of sustainability in thermal and design engineering should be included in ABET criteria. Mechanical Engineers should apply principals of green design to develop appropriate, cost effective, and high performance mechanical, and energy systems integrated into the projects. ABET should include: Reduce waste, re-use parts & components at end of life, rework & refurbish suitable parts, recycle as far as possible and remanufacture so far economical. The added importance should be given to the teaching of: Optimizing energy and water conservation; effect of design on GHG emissions; Proving appropriate and sensible control systems and devices; insuring ease of system maintenance and operations; Allowing for future flexibility and adaptability. These considerations will enhance engineering benefits to consumers by allowing for better coordination, increased sustainability, and benefit at no additional cost. They need to play an increasing role in the promotion of a sustainable society. How engineers are educated has a significant effect on the way in which they work and the way in which they understand their role in sustainability. This paper explored the need for engineers to be educated in sustainability and provides an excellent vehicle for understanding of sustainability principles.

4. Sustainability and Thermodynamics

It is generally recognized that thermodynamics and fluid mechanics are very complex and challenging field for mechanical engineers and these courses explained further in thermal and fluid mechanics labs. These courses are also further explored through simulation in advanced Computer Aided Engineering lab. A thermodynamic system is defined as a physical entity of a complex structure that consists of a finite set of constitutive elements having: 1) a known type of such constituent, 2) defined internal constraints that control interactions between constituents, 3) a known nature of internal forces, and 4) explicitly listed generalized coordinates that describe all actions of external forces. All engineering systems whether in design or manufacturing should follow the rigorous thermodynamic definition of system. The sustainability approach tries to identify how far from equilibrium (vs surroundings) a process and/or its outcomes are at any instant of the life cycle. Manufacturing system sustainability assessment is the philosophy that a change of a property of a raw material under processing in open manufacturing system or assembly line. It contributes to a certain degree to an overall outcome of all the interactions between material flows and surroundings. At the end of useful life, it returns to environment (landfill), and it started its journey from its extractions from mines. This is a full life cycle or a full sustainability. In engineering curriculum, we start from materials and end at the end of manufacturing processes, without considerations to energy requirements before materials being processed and what happens to the systems & components at the end of life. It is conceivable to consider such systems as closed systems instead of open system and all the thermodynamic properties of exergy and/or entropy generation should be applied for sustainability. Energy resources of various kinds help in running industries producing useful products for human development. However, it also creates pollution and environmental degradation of atmosphere, land, and water. And we know there is no substitute for water and air. Many of these side effects of production and consumption give rise to resources depletion and environmental hazard world over. We can make best use of thermodynamics by focusing on bio-physical resources and using aggregate measures of the second law regarding conversion of resources, such as energy change and entropy production.

Thermodynamic concepts have been utilized by practitioners in a variety of disciplines with interests in environmental sustainability, including ecology, economics and engineering. Widespread concern about resource depletion and environmental degradation are common to them all. It has been argued that these consequences of human development are reflected in thermodynamic parameters and methods of analysis. Exergy', a quantity which follows from the First and Second Laws of Thermodynamics, has been viewed as providing the basis of a tool for resource and/or emissions accounting. It is also seen as indicating natural limits on the attainment of sustainability. This indicates the scope for increasing energy efficiency, and the extent of energetic 'improvement potential', in each of these areas. Poor thermodynamic performance is principally the result of

exergy losses in combustion and heat transfer processes. Mass, energy, and exergy balancing should be incorporated in all engineering courses to account for sustainability. These are not applicable to steady or quasi-steady and closed systems. Such analysis tools are applicable to diverse materials processing operations, such as machining, heat treatment, forming & forging processes, diffusion and phase change processing, etc. Sometimes these systems are inefficient in terms of energy and our graduates should be sufficiently exposed to these tools. There is clear relationship between energy efficiency and quality of product. There is need for integrating such concept at early stage in thermal engineering and transported to other design and manufacturing courses. Here an outline of basic Thermodynamics course including sustainability considerations is presented.

- 1) First law of Thermodynamics:
 - Heat, Work, thermal efficiency and difference between various forms of energy.
 - a) Heat Balance equations and examples.
 - b) Energy Balance equations & problems.
 - c) Mass Balance equations and problems
 - d) Steady-flow energy equation; Open and closed systems (mass balance).
 - e) Conservation of energy (Energy Balance problems & examples).
- 2) Ideal Cycle Analysis;
 - a) Estimate thermal efficiency; energy balance, loss of energy.
 - b) Work as a function of pressure and temperature.
 - c) Mechanical Equilibrium.
 - d) Thermal Equilibrium (Thermal Balance).
- 3) Applications of first law of thermodynamics;
 - a) Thermodynamic cycle & Heat engines
 - b) Otto cycle
 - c) Brayton cycle
- 4) Applications of Steady-flow energy equation:
 - a) Mass balance or conservation of mass equations & examples.
 - b) Conservation of energy
 - c) Steady flow energy equation
 - d) Enthalpy & applications.
 - e) Examples applications of steady flow equations. Adiabatic considerations.
- 5) Second law of thermodynamics (concept of Entropy);

The Second Law of Thermodynamics could be interpreted as tendency of everything to return to an elemental state. The link between the efficiency of resources utilization, energy consumption, and GHG emission is real and second law of thermodynamics should be studied from this angle. The relation between engineering, economic, and society are illustrated by sustainability and is shown below by Venn diagram shown in Figure 1. The Venn diagram in Fig.1 shows the practical framework for the use of thermodynamic ideas and analysis in second law in larger concept of environmental sustainability. Fig.2 shows all practical parameters for sustainability underpinned by thermodynamic principles. Thus, the topics under second law of thermodynamics to be covered are outlined below.

 - a. Reversible Processes and examples.
 - b. Entropy and environment
 - c. Mass, Energy & Exergy balance for continuous, transient and variable-mass manufacturing systems.

6. Green Design and Manufacturing for Sustainability

In the design and manufacturing stream of mechanical engineering, the solid mechanics plays most significant part. All the basic theories of mechanics are helpful in component and system design including manufacturing. However, the mechanical engineering doesn't include the concept of environmental degradation due the decision made during design phase. Actually the design effects the manufacturing and manufacturing in turn effects the environment. We need to include in mechanical engineering the sustainable or green design including the concept of manufacturing for sustainability. Mechanical Design in itself has no ecological dimension, but its impact on the manufacture and use of product is immense. Decision at design stage constrains the avenue of possible change down the line or later on the life of product. The concept for Design for Environment (DOE), or Sustainable Design should be integrated very closely in the engineering mechanics and/or Mechanical Engineering Curricula. It should not only emphasize on Green Manufacturing but all the aspects later in the life cycle of the new product including use, end-of-life, and disposal. The very concept of a new product should raise the question the need for the product could be by reusing, reconfiguration, and remanufacturing. It will not only save materials, engineering, lower GHG emission, lower carbon footprint, and increase profit for the industry.

6.1 Sustainable design

Sustainability is defined as a requirement of our generation to manage the resource base such that the average quality of life that we ensure ourselves can potentially be shared by all future generations. Sustainability is the ability to continue a defined behavior indefinitely.

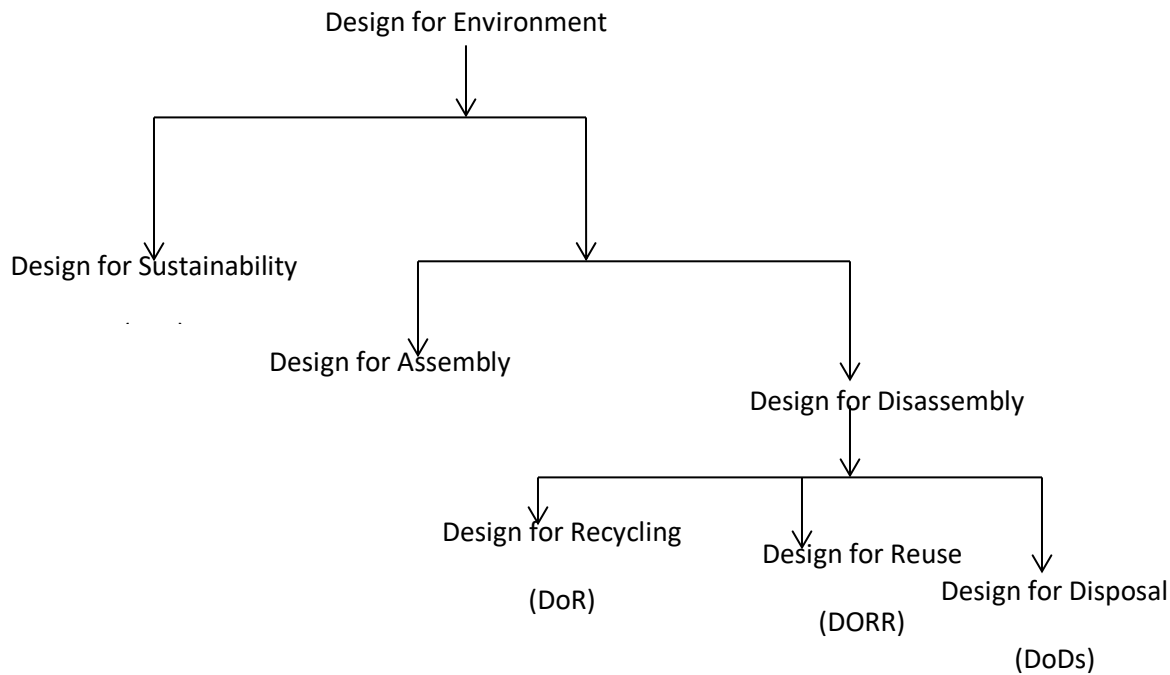

Figure 7: Sustainable Design

Green design and manufacturing promises reduction in materials, energy use, disposal fees, and reduced pollution. Products should be designed keeping in mind the aspects of disassembly and recycling. Engineering curriculum has to catch up with the needs of society in general for sustainability considerations. The end-of-life considerations including recycling and reuse should be integral part of Mechanical Engineering curriculum. The selection of suitable materials, processes, and geometry that satisfies specified and implied green functional requirements should be goal of mechanical design. A curriculum revision and development of two separate courses on Green Design and Sustainable Manufacturing are being proposed. Engineers need an understanding of whole systems, life cycle, and end of life utility of the product and they have been emphasized in the new courses being developed. This is in consistent with National Science Foundation (NSF) objective as well as the requirements of American Society of Mechanical Engineers (ASME). There is need to modify the undergraduate curriculum to include sustainability considerations in mechanical component design and manufacturing courses.

The path towards sustainable engineering education is obvious and the engineering professors should recognize and communicate the epic nature of the sustainability discourse. The engineering education community needs to include sustainable engineering in curriculum. Unfortunately, few engineering schools have made major updates to their courses and curricula over the past few decades. However, making such updates is thwarted by the significant amount of time needed to make changes, the challenge of inserting new material into already crowded courses and curricula, and the lack of a sense of priority about such changes. We need to include in our courses topics such as life cycle assessment, concepts in renewable energy, and methods of waste minimization. Leading institutions in the United States have recognized that sustainable development should have a prominent role in engineering education and practice. The criteria used to accredit engineering education programs have also recognized this need. The Accreditation Board for Engineering and Technology (ABET) requirements for program outcomes and assessment, identifies that besides the knowledge in math, science, engineering principles, and problem-solving, engineering graduates should possess the ability to: function on multidisciplinary teams, communicate effectively, and understand professional and ethical responsibility. A review of courses offered within and outside the School of Engineering show varying ways and to varying degrees' inclusion of sustainability. A Venn diagram for sustainable development is presented in Fig.3. for sustainability the social, environmental, and economic development must be integrated and balanced. The core of the Venn diagram is sustainable, which should guarantee balance environment and economic development, along with equitability of society and the economic development. The environmental degradation due to economic activities must be bearable for society in general.

Our attempt should be to integrate green design and manufacturing within the framework of sustainability in engineering curriculum whichever way the faculty decides. Enhancing the sustainability of manufactured product is a critical subject for the coming generation of engineers. It would result in reduced materials requirements, reduction in energy use, reduced disposal fees, reduced pollution and finally fewer problems for society in general. The aspects of disassembly and recycling should be included in product design. It would help to reduce toxic and otherwise harmful emissions to the environment causing global warming, and ensure sustainability. We should advance the following goals in engineering curriculum for sustainable future: 1. Reduce the use of resources including materials, energy, and water etc., 2. Reduce toxic and otherwise harmful emissions to the environment causing global warming, 3. Manage renewable resources to insure sustainability, 4. Quality and durability: Longer-lasting and better-functioning products will be replaced less frequently, reducing the materials requirements in future, 5. Design for reuse and recycling.

Material selection effects largely on the environmental impact and it should be considered very critical in design and manufacturing. Performance indices to minimize the environmental impact have been developed by Ashby [5] and it should be included in the design courses. Along with the traditional mechanical engineering design tools, the design for environment (DFE) should be integral component of mechanical design and it should be included in the ABET requirements. The extrinsic properties along with the embodied energy, GHG emission, and cost should be included in the design process.

It is proposed here to develop a series of courses on Design and Manufacturing for Sustainability (DMS) or Green Design and Manufacturing for Sustainability (GDMS). These courses would be useful for graduate and undergraduate curriculum. The course will be prepared for a future where Green Design and Manufacturing has zero net impact on the environment. These courses will present traceable information (topics) which are critical to product designers and manufacturing engineers so that they can incorporate sustainability in their occupation and comply with international regulations. The template of a course is presented below in Fig.3. The courses will emphasize on the integration of cost, recyclables, and or reuse during the design and manufacturing stages. For sustainability the life cycle cost consideration is critical and it is included the course outline.

Green design or design for environment (DFE) has the main aim of reducing the waste of material and greenhouse gas (GHG) emissions into the atmosphere. There is enormous cost of materials going to landfills and many of these waste materials may be usable with proper refurbishing and recycling. The designers have the greatest influence on the product's composition and the burden of creating products that is easy to disassemble, reuse and recycle falls largely upon their shoulders. There is need for environmentally friendly design, which can reduce waste, encourage recycling and reuse of the components at the end-of-life, reduce emissions of GHG. The curriculum being developed emphasize on total life cycle of the product from grave-to-grave or at least from grave – to- gate. Some important aspects of design for the environment are; manufacture without producing hazardous waste; use of clean technologies; reduce product chemical emissions; reduce product energy consumption; use of non-hazardous recyclable materials; use of recycled material and reused components; design for ease of disassembly product reuse or recycling at end of life. These issues must be included in curriculum being developed at Manhattan College for sustainable study. The following topics are proposed to be included and integrated in undergraduate engineering curriculum. These topics are presented with examples and problems as module 1 for teaching.

Designs for Assembly

To improve percentage of recycling and reuse appropriate steps must be taken at design stage. Reducing the number of parts or components in the assembly makes it easier to manufacture and assemble. The proper material will also affect the assembly cost. Although slightly different in detail, focus on the following issues is needed. • Material e.g., reduce overall material diversity, avoid the use of laminates or make them out of compatible materials which can be recycled as a mixture, • Fastener, e.g., reduces fastener count and diversity; avoid incompatible adhesives which degrade recyclability of materials, use snap fits where appropriate, • Component design issues, e.g., avoid paints and laminates; build in planes for easy separation and access. Some of functions of one component may be integrated with other components or eliminated altogether to reduce cost. It will encourage recycling and reuse.

Designs for Disassembly

Design for Disassembly (DfD) must be incorporated in the early stages of product design, when the structure of the product is determined. The Design for Disassembly (DfD) saves money including reduces materials wastage, GHG emission, and landfill costs, and above all improves the environment. In traditional engineering design curriculum, the problems of recycling, reuse, and landfill or incineration were barely touched. This requires quite different thinking in a modern engineering education. An example of disassembly problem is presented below as module 1. Below an example for design of disassembly along with cost and the GHG emission estimation is presented.

Example for disassembly: The time to disassemble the screw will depend on the length of the screw, which depends upon the thickness of two parts assembled. If the nominal diameter of the screw is 0.125", then there are 40 threads/inch (UNC) threads or 44 threads/inch (UNF) threads. The time to unscrew the screw is $44(140) = 1960 \text{ TMU} = 70.56 \text{ s}$. If we assume there 15

screws in this assembly of two steel plates, disassembly time= $15(70.56) s + 15(34.7)(.036) s = 1077.138 s = 17.9523 \text{ min}$. Steel plates of 24''x24''x1/2' of 81.2 lbs. are considered. Plates are heavy items and to move those to recycle or reuse bins need help of one more person and both hands have to be used. It is getting control over an object with the hand or fingers and placing the object in a new location. In MTM-1 (Yi et al., 2003), these steps are: Reach, Grasp, and Move. If we take predetermined times from tables 3, 7, & 4; time for moving one plate is $= (23.2+2.0+22.7) = 48 \text{ TMU}$ for moving the plate by 30'' However, these plates are heavy of 81.2 lbs., the time elements modified for weight $= 1.5 \times 48 \times 81.2 = 5846.4 \text{ TMU} = 210.4704 s = 3.5 \text{ min}$. For both the plates, the time to move them would be 7 min. Therefore, the total time for disassembly would be, which seems to be reasonable time to unscrew all 15 screws with flathead screw driver and move the plates about 30'' from the workbench. We assume only 25% of the screws are reusable and rest have to be recycled. The degree of difficulty is the relative degree of disassembly of the nuts & screws, which is normally in the range from 1.5 – 2.0. The time of disassembly should be multiplied by the degree of difficulty (dod) factor to accurately estimate the disassembly time. By assuming 25% screws are reused and rest 75% are recycled after shredding, the following steps are taken in estimating the end-of-life (EOL) or the recycling & reuse benefits;

Reuse value = Cost of component (\$) – Miscellaneous cost (\$)

The miscellaneous cost is composed of collection plus reprocessing costs and it is zero here. Therefore, Reuse value= \$per part reused x # of parts reused = \$3.00 (here for illustration \$ per part is assumed as \$1.00, which not true in market). Remanufacture value represents the value of component after disassembly the parts are reprocessed or refurbished before reusing them. The remanufacturing cost sometimes may involve machining, cleaning, removing paint, or cleaning for any corrosion on the part.

Remanufacture value = \$per component x # of components – remanufacture cost/component x # of components = $\$3.00 - \$0.10 \times 3 = \$2.70$. Primary recycle value here consists of 12 screws and two steel plates. The primary recycle value: Primary recycle value = # of screws x weight/screw x cost of recycled material + # of steel plates disassembled x weight per plate x cost of per pound of material reused = $12 \times 0.0625 \text{ lb/screw} \times \$0.50/\text{lb} + 2 \times 81.2 \text{ lbs. /plate} \times \$ 0.20/\text{lb} = \$ 32.9$ (Here screws are of alloy steel and plates are of cast iron).

The shredding cost needs to be accounted for in the EOL cost as well.

Shredding Cost = hourly shredding cost/hr. x # of hours used to shred one lb of material x weight of shredded material. The shredding cost is estimated as; $\$30/\text{hr.} \times 1/2 \text{ hr.} /\text{lb} \times 163.15 = \$2,447.25$

The shredding cost seems very high and recycling may be uneconomical. After shredding material is reprocessed & sent at the entering point of production process.

Embodied energy in recycling; The value of embodied energy in the recycling (Gunoor et al., 1999) is estimated now. The total material of alloy steel and cast iron are 0.72 lbs. and 162.4 lbs. respectively. The embodied energy of fresh material used in production or manufacturing process;

Embodied energy of fresh material = $(0.72 \text{ lbs.} \times 0.454 \text{ kg/lb} \times 35 \text{ MJ/kg}) + (162.4 \text{ lbs.} \times 0.454 \times 17 \text{ MJ/kg}) \times 948 \text{ Btu} = (11.5 + 1253.5) \times 948 = 1.2 \times 10^6 \text{ Btu}$

The energy required to process recycled the materials: **Embodied energy for recycled material** = $(0.72 \times 0.454 \times 10 \text{ MJ/kg} + 162.4 \times 0.454 \times 5.2 \text{ MJ/kg}) \times 948 = (3.3 + 383.5) \times 948 = 0.37 \times 10^6 \text{ Btu}$

The energy saved = $(1.2 - 0.37) \times 10^6 = 0.83 \times 10^6 \text{ Btu}$. The savings in terms of dollars could be estimated. Normally energy drawn from electric grid, coal, or heavy oil, etc. differ in price but everyone had different environmental impact in terms of carbon footprint, which is supposed to be main cause of global warning. The energy price is used here as \$0.035 /MJ and so the savings in terms of dollars = $(0.83 \times 10^6 / 9.48) \times \$ 0.035/\text{MJ} = \$ 31.00$.

Carbon footprint estimation; Carbon footprint of fresh material = $(0.72 \times 0.454 \times (2.125 \text{ kg/kg}) + 162.4 \times 0.454 \times (1.1 \text{ kg/kg})) = (0.7 + 81.1) = 81.8 \sim 82 \text{ kg}$ of CO₂ is emitted in atmosphere when we use fresh materials in this process. The Carbon footprint of recycled materials = $(0.72 \times 0.6 \text{ kg/kg} + 162.4 \times 0.31 \text{ kg/kg}) \times 0.454 = 23 \text{ kg}$. This shows that there is reduction of $(82-23) \text{ kg} = 59 \text{ kg}$ of CO₂. For this small disassembly process, the reduction in terms carbon footprint is very significant or quantifiable.

Economics of End-of-Life in Design for Disassembly (DfD); The estimated life cost consists of the manufacture, assembly, maintenance, remanufacture and recycling costs as determined by the choice of fastening or joining method. The recycling cost represents (Feldman et al., 2001) the expense of material separation, and not material reprocessing. The assembly and disassembly costs are estimated using time required for disassembly and assembly of various fastening and joining methods.

Recycling Cost; The cost of separating parts made of different materials. where Cr is cost of material recovery equivalent to the product of cost of material recovery (and weight of material recovered () . k represents types of material recovered, like, copper, steel, etc.

Repair and maintenance Cost

The repair and maintenance cost consists of disassembly and reassembly expenses, which represents time required for disassembly and reassembly at field labor rate, and the expected cost of part and fastener replacement due to damage incurred during disassembly and assembly.

Remanufacture Cost

The remanufacture cost imposed by the fastening method also consists of expenses related to disassembly, reassembly and the probability of part and fastening method failure.

In general, the remanufacture cost is modeled as follows:

C_{rm} = Remanufacture cost, T_d = Disassembly time, T_a = Assembly time, h = Labor rate (\$/hr.), P_f = Probability of fastener failure in disassembly and assembly, C_f = Cost of fastener failure, P_p = Probability of part failure in disassembly/ assembly, P_e = Probability of part failure in fastening-method extraction, C_p = Cost of part failure. The probability of part damage during disassembly is defined to be zero, i.e.. The probability of fastener damage in disassembly, i.e. and the general remanufacture cost reduces to: $C_{rm} = (T_d + T_a)h + C_f + C_p$. If the part cannot be repaired, the consequential cost is part replacement cost. In such cases, and. The new cost equation for remanufacturing is: $C_{rm} = (T_d + T_a)h + C_p$. The remanufacture cost will include disassembly and the consequential cost of part and fastener failure. For $P_f = 1$ and $P_p = 1$, the general remanufacture cost reduces to:

$$C_{rm} = (T_d + T_a)h + C_f + C_p.$$

Example of Recycling

A hypothetical example for the recycling of materials from disassembly of a system is presented. The system parts are made essentially of copper and steel, although some other materials are there but they have to be dumped as it could not be recycled. Total weight of the system is about 24 tons. There are 3 ($m=3$) similar joints but only 2 ($n=2$) different types of fasteners. However, among the 3 similar joints, 2 fasteners are in contact with same type of materials ($g=2$). We need different types of tools to disassemble the components of the system and times taken to disassemble the components are:

All times are given in hours. Materials that are shredded are mostly dumped and that is about 10 tons. The shredding equipment is quite efficient and takes only 20 hrs. to shred it. The shredded components are dumped and the weight of dumped material is also 10 tons. The cost of steel recovery is \$15/ton and cost of copper recovery is \$100/ton. Steel 12 tons and copper 2 tons are recovered. The dumping cost depends on the land price, and other special materials, chemicals, cover etc. are used in dumping. The weight of material dumped is same as shredded material of 10 tons. The cost of dumping is \$1,000.00/ton. We will estimate the benefits resulting from reduction in emissions and energy in analysis of recycling including revenue. The benefits from these aspects are presented below.

, where represents the energy savings from using used steel and copper and are reduction in emissions of hazardous gases (GHG) emissions in atmosphere. The steel and copper are recycled 12 and 2 tons respectively. The average embodied energies are 35 MJ/kg for primary production and 10 MJ/kg for recycled material. The savings in energy resulting from using recycled steel is 25 MJ/kg. Similarly, for copper the saving in energy is $(71-17.75) = 53.25$ MJ/kg. The reduction in carbon dioxide emissions by using steel is $(2.125-0.6) = 1.52$ kg/kg and the reduction in emissions due to copper recycling is $(5.35-1.3) = 4.05$ kg/kg. (Ashby, 2007). The external cost of emissions should be considered as the cost of containing the hazards due to CO2 emissions. It should be considered as savings or benefits of recycling. Considering the savings due to reductions in emissions as \$5/ton of reduction in CO2 emissions, the total benefit from reduction in CO2 is;

. This is the total energy saving due to recycling of steel and copper. The energy cost of \$0.031/MJ is for the energy from grid. The benefits due to reduction in emissions is

Total benefits due to recycling on energy savings and reduction in emissions is \$84301.5.

The benefit from recycling of both steel and copper (R_m) is calculated as;

Some disassembled mechanical components are difficult to reuse, however, components like, gears, flywheels; springs, etc. are easily reused. Here five gears are reusable after disassembly and the sale price of reused gears as \$400.00/gear. Hence, the revenue occurring from reusing of gears is

. The total cost (TC) estimated below.

(Disassembly cost)

Shredding cost (Cs) = , (Cr) = (recovery cost). Dumping cost (DC) = ,

Total cost (TC)= \$405.00+\$7000+\$380.00+\$10,000=\$17,785.00.

The net profit from recycling =Total Revenue-Total Cost =\$ 93715.5 and The Benefit-Cost ratio.

The Benefit cost ratio is greater than 1 and is acceptable. The basic principles of sustainable green design and manufacturing with proper examples need to be included in the curriculum to transform the undergraduate education.

7. Concept of Green Manufacturing

For sustainable manufacturing profit is essential for all primary, secondary, or tertiary industries. Profit will encourage sustainable development. It is essential that costs including operation and maintenance are minimized. The common components of costs and their contribution towards the total cost of products is presented as: manufacturing cost = 40%, Engineering and design cost = 20% Administrative and marketing costs = 25% and Profit = 15%.. This shows that to make th enterprise more sustainable the costs of engineering and manufacturing must be decreased, so that profit increases. However, we must not miss the environmental impact of manufacturing and design. The ecology of production process helps to improve knowledge of various aspects such as use of materials, reduction of waste, and reduction/prevention of pollution during manufacture of the product.

The mechanical engineering design and manufacturing courses should also include the energy required for the product manufacturing energy as well as the embodied energy. The reduction in the total energy not only reduce cost but it will reduce the GHG emissions as energy consumption is directly related to environmental degradation. ABET in their document Engineering Criteria 2000 states that students must be prepared for professional practice through a curriculum that includes “most of the following considerations: economic, environmental; sustainability [italics added]; manufacturability; ethical, health and safety; social; and political.” Just may be 80’s ABET did not insist on ecological considerations and University can disregard or ignore such ethical concern. In present age due to increasing consumption of materials and energy and increasing GHG emission and consequential pollution and finally global warming, ecological considerations are compelling imperatives which Engineering Schools cannot ignore. These concern has generated immense interest in the Sustainability Science and its inclusion and integration in the Mechanical Engineering Curricula should not be ignored. US universities are beginning to introduce the principles of sustainable development into their curricula.

Green manufacturing is defined as the creation of manufacturing products that use materials and processes that minimize negative environmental impacts conserve energy, and natural resources, are safe for employees, communities, and consumers, and are economically sound. The effect of manufacturing on environment, greenhouse gas (GHG) emissions and global warming should be emphasized in engineering education. Renewable energy sources like wind power, solar power, natural gas, etc. will reduce GHG emissions considerably. Manufacturing processes consumes enormous energy resource and it has significant impact on the environment. Therefore, manufacturing processes courses should emphasize on minimizing the energy requirements for the materials as well as for manufacturing processes, and exergy transformations in manufacturing processes. Integration and application of sustainability considerations in manufacturing can also turn into asset in the competitive global manufacturing atmosphere. Consumers are becoming conscious of goods and services which are environmentally friendly. To cap it all, investors and Wall Street evaluate products and industries based on environmental risks and environmental impact before investing. Therefore, industries are going beyond profit, toward sustainability. The waste minimization requires knowledge of the production process, and tracking of materials from their extraction to their return to earth (cradle-to-grave). The Fig. 8 below shows various aspects of Sustainable Manufacturing.

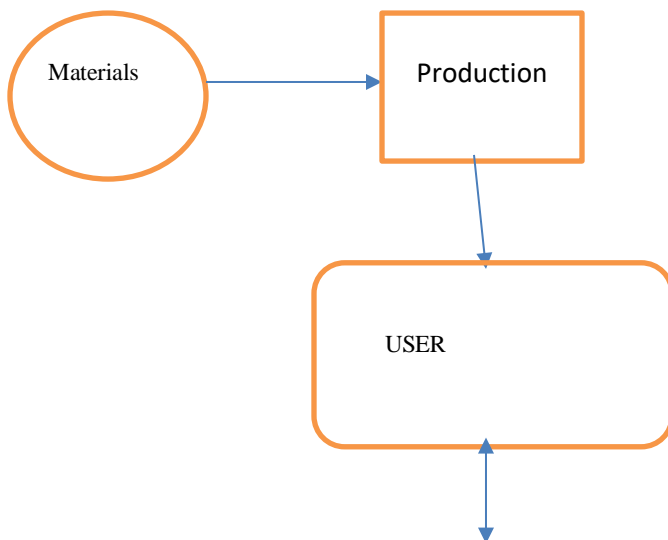

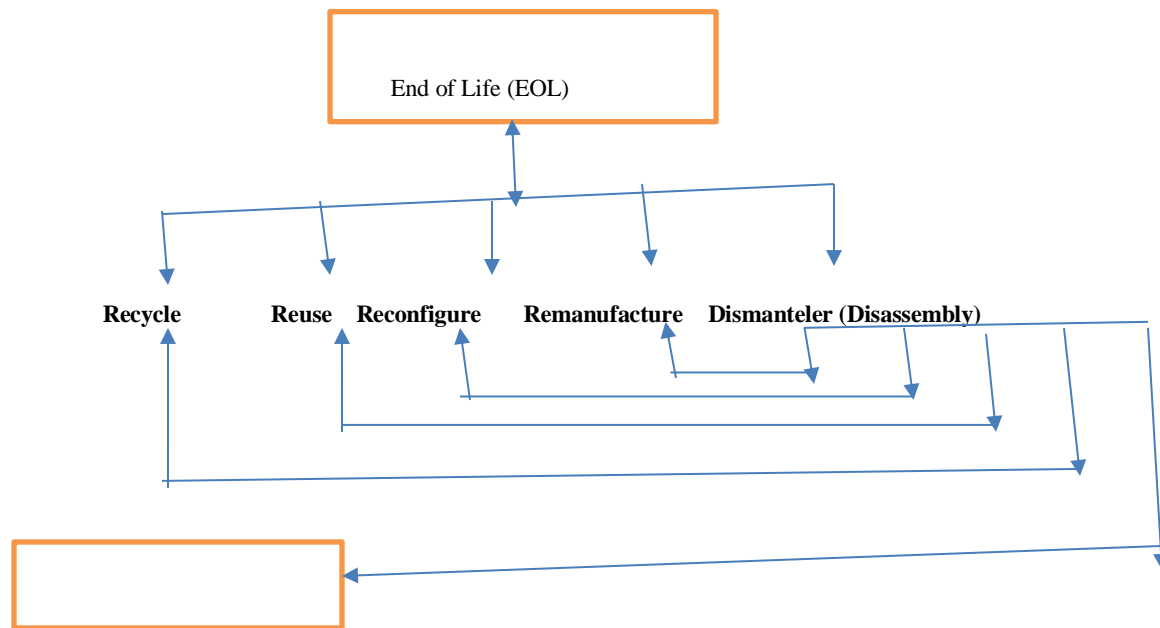

Landfill: Shredder, Parts for recycling, Reuse, other Utilization, Special industrial waste, Destruction, to Landfill

Figure 7: Sustainability in Manufacturing

7.1 Curriculum development in green design and manufacturing for sustainability

The ABET outcome 11 emphasizes that mechanical engineering students should understand the impact of engineering solution on health, safety, the environment and welfare of the public. The course being developed will be able to integrate these considerations into their design and manufacturing practices. The course outline for Green Design and Manufacturing for Sustainability is presented below.

1. Introduction to ecology, sustainability principles, green design and manufacturing of a product.
2. Material Selection; Eco-properties of materials, merit Indices and material Properties Chart,
3. Analytical Techniques; Design for minimization carbon footprint & embodied energy, green design constraints, recycling, reuse, & end-of-life treatment, life cycle analysis, mass & energy balance in manufacturing systems.
4. Computer aided design, FE analysis and green considerations in mechanical component design.
5. Cost estimating & consumer considerations; recycling, reuse, and end-of-life (EOL) considerations.
6. Environmentally Benign Manufacturing processes; Green Manufacturing; Theory and Practice, Reduction of energy consumption in material removal & forming processes, Reduction of waste and toxic dispersion of manufacturing, Health & safety considerations in manufacturing.
7. Quality consideration and quality for sustainability, Analysis of snap fit design.
8. International regulations for sustainable design and manufacturing.

7.2 Sustainable Manufacturing

Manufacturers across many industries increasingly emphasize sustainability. Design –for- sustainability (D4S) takes a holistic approach analyzing operational efficiency, safety, functionality, productivity, materials use, ease of operation, and maintenance. The Sustainable Manufacturing would be open to undergraduate and graduate engineering students along with MBA's. The

course is designed to be multidisciplinary where project groups will comprise of students from all engineering disciplines including business major. The ABET outcome 9 emphasizes the importance of interacting with people in disciplines outside of mechanical engineering. The course is being developed as a common course for both engineering and MBA students. The various aspects of sustainability will be presented through case studies from real world. The techniques and economics of waste reduction, recycling, cost/benefit analysis including life cycle cost will be presented. Engineering and business students will join in small groups for product development. The course outline is presented below.

1. Introduction to sustainability in manufacturing; Characteristics of successful product development.
2. Net shape manufacturing and minimization of energy; Sustainability measurement throughout life cycle
3. Thermodynamics in manufacturing and Energy analysis
3. Economic analysis; technological advancement for green manufacturing, allocation of resources.
4. Environmental impact & steps to reduce it through redesign, remanufacturing and data mining
5. Green Product specifications; metrics of sustainability & cost model of the product and the process.
6. Sustainability in new product development; selection matrix; combine and improve the concept.
7. Design for manufacturing sustainability; cost, wastage, energy, quality and environmental impact.
8. Managing Green Manufacturing Projects; PERT & CPM, risk in green manufacturing, project evaluation.

Sustainable Engineering Education

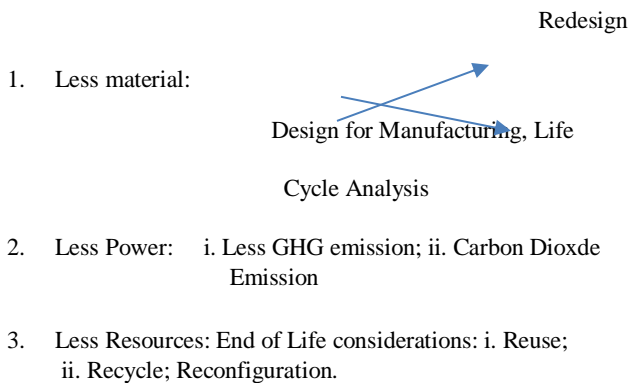

Engineering Education needs retooling and restructuring of all engineering courses from Undergraduate to Graduate level by:

- i. Modifying the Curricula
- ii. Introducing some Apex courses
- iii. Interdisciplinary courses

Some **Graduate Level Courses** to be developed to include Sustainability in the curriculum are introduced below.

1. Green Mechanical Design

Topics Included:

1. Intro to green design and sustainability; Sustainability, Design for Environment (DfE).
2. Business concerns for green design, metrics for green design. Environmental analysis; footprint indicators, Life cycle assessment,
3. Mathematics for green design; minimization of materials content, Break even analysis for end-of-life calculation, Life cycle accounting, Cost/Benefit analysis.
4. End-of-Life Considerations in Product Development
 - 4.1 Mathematics of Reuse and Recycling; materials saving, energy savings, Carbon footprint & GHG emission.

- 4.2 Mathematics of Remanufacturing, Reconfiguration, and landfill.
5. Green Spring Design; material selection based on sustainability, minimize total embodied energy, end-of-life treatment for helical compression and torsion spring, Belleville springs and miscellaneous spring.
 6. Design-for-Environment of Gears; Spur gear, Helical gears, worm gears, and Bevel gears, Gear design for least embodied energy, least power consumption in manufacturing of gears, End-of-life considerations for gears, Reuse, recycle, and remanufacturing of gears, life cycle analysis of gears.
 7. Use of Bearings and End-of-life considerations; Sliding-contact bearing, materials selection, lubrication selection for least toxicity, design of green bearing; Ball bearings; bearing life estimation, ball bearing selection, reduced environmental footprint by reusing and recycling bearings, recycling of lubricants. Plastic Bearing.
 8. Design for Assembly and Disassembly; Press & shrink fits & tolerances, effect on cost and strength of the assembled components, stresses in joints, end-of-life considerations of fasteners, design for environment (DfE) of fasteners, Reuse and Recycling of fasteners, materials power, and energy savings, Life cycle analysis of fasteners.

2. Environmentally Benign Manufacturing

1. Introduction to green manufacturing; Life-Cycle thinking in manufacturing, environmental analysis; footprint indicators, predictive simulation and risk analysis, reduce the total life cycle cost, reduce adverse impacts to worker's health.
2. Mathematics for Sustainable manufacture; optimization, minimization cost and energy, end-of-life consideration in grave to grave analysis, Benefit/Cost analysis, Break-even analysis for cost and benefit, sustainable engineering toolkit, GHG emission and estimation,
3. Thermodynamics in Manufacturing Sustainability; Life cycle assessment, methods for materials and energy balance, estimation of energy consumption in manufacturing operations, Environmental burden of cutting tool design, National emission standards for hazardous air pollution (NESHAP); compressed air, burner control, process control, motors, pumps & fans.
4. Eco-manufacturing Processes; Materials and Process families, Energy requirement of materials, Strategy for minimization of energy and Eco-impact, Life cycle analysis & selection strategies.
5. Milling Machine Life Cycle Assessment and Performance; Narita's algorithm for environmental burden estimation, Burden of coolant & lubrication, Estimation of energy footprint and environmental burden of cutting tool and Milling Machine.
6. Turning Operation and Life Cycle Analysis (LCA) of cutting; Materials & Energy balance, Environmental Burden of single point cutting tool, waste stream after machining, Environmental burden of Dry Vs Wet manufacturing and minimum quantity lubrication (MQL) during machining.
7. Sustainability Considerations in metal cutting; Coolant selection, coolant concentration, contaminant control and removal, representation of eco-indicators of tool materials and estimated energy footprint for tooling, Environmentally Friendly Machining Model.
8. Eco-friendly Foundry Processes; introduction to solidification of Foundry Process, environmental issues and efficiency of metal casting, EPA's environmental statistics for Foundry industries, Energy use compared to metal removal processes, environmentally conscious Sand Casting, Shell molding and investment casting, Heat transfer in casting and continuous casting, solidification time estimates and environmental impact.
9. Eco-Friendly Metal Forming Processes; Design considerations in forming operation, energy estimates and comparison with other manufacturing operations, observations on energy use pattern of different forging operations, mass balance and energy balance, Health hazards of forming industries; forging, rolling, extrusion, and sheet metal processes environmental and health impact; energy and power calculations in forging, forming, and sheet metal industries, health hazards of Heavy Metals.

3. Product Development under Sustainability Considerations

This Graduate course is open to majors in Engineering including MBA students from Business School. The course will detail the concept of a Product Development Under Sustainability consideration. It will detail the principles of sustainability, industrial requirement and ecological considerations of a product. It will include a group project and case study.

1, Sustainability; a sense of urgency, emergence of sustainability, global sustainability agenda, response of industry and regulations, rediscovery of ancient values, green expectation, how clean is Green? confronting climate change, no substitute for water, recycling technologies.

2. Design for Sustainability; Sustainable initiative, cleaner production, design for sustainability, Life Cycle Analysis, Design for Disassembly and recycling, material flows and cycles.

3. Industrial Ecology and Sustainability; Global warming; material and heat balance, energy balance, Embodied Energy economics.

4. Economics of Sustainable Engineering; Cost-Volume relation, Life-Cycle Cost analysis, Efficiency and life cycle cost analysis of a pump, reduced energy cost etc, Cost estimating techniques, Benefit-Cost relation for Recycling,

5. Environmental impact & steps to reduce it through redesign, remanufacturing and data mining.

6. Green Product specifications; metrics of sustainability & cost model of the product and the process.

7. Sustainability in new product development; selection matrix; combine and improve the concept.

8. Design for manufacturing sustainability; cost, wastage, energy, quality and environmental impact.

9. Managing Green Manufacturing Projects; PERT & CPM, risk in green manufacturing, project evaluation.

A Group Project will be assigned to each group and it should be designed and manufactured under the sustainability consideration. Case studies will be presented for every topic detailed above related a relevant industry.

Grading Policy:

Test I ----- 30%, Final -----30%, Group Project-----30%, Quiz-----10%.

4. Sustainable Engineering Economic Analysis

The course will include the basics of engineering economics for sustainability. It will detail the economic principles as well as industrial practices for sustainability. The regulations for green engineering and product development for most of the industrial economics of the world will be presented with major emphasis on US industries practices.

1. Industrial Ecology and Economics; Why green? Major industrial economy and their practices, Does Green makes sense for industries? Global warming and its effect on economy, Eco-labelling program, Sustainability goes mainstream, evolution of environmental strategies.
2. Economics for Sustainability; Mathematics of Profit Vs. Sustainability, Grave-to-Grave Life Cycle Cost Analysis, Economics of Solid Stat Vs. LED lighting, economics of design for recycling for plastics in electronics.
3. Economic Analysis of Public Sector; From waste to Power and Money, Investment objectives, Viewpoint for Analysis, the Benefit-cost ratio analysis, other effects of Public Projects; Project financing, project duration, quantifying and valuating Benefits and disbenefits, Project Politics & sustainability.
4. Selection of Minimum Attractive Rate of Returns: What is rate of return on Public Projects; Dam, Power station, Highways, etc., Sources of Capital, Cost of Funds, Investing opportunities.
5. Economics of Inflation and Price Change affecting Sustainability; Price trends in Solar Technologies, Meaning and Effects of inflation, Analysis of Constant Dollars Vs. the-current dollars on sustainable development, Inflation effect on after tax estimation.
6. Income Taxes for Corporation; Calculation of taxable income, Economic Analysis taking Income tax into account, Effect on income due to Carbon tax, and monopoly tax, Break-even point and its effect on depreciation, profit, and sustainability.
7. Depreciation and Sustainability; Depreciation and intangible Property, Basics of Depreciation, Depreciation and End-of-life considerations, Depreciation and Asset Disposal, Depletion of resources materials, cost depletion, cash depletion etc.
8. Uncertainty in Future Events; Estimates of Uncertainty estimation and their use in economic analysis for sustainable development, a Range of estimates, Probability and Joint Probability distribution for new green products, Expected value and sustainability, Economic Decision Trees; Risk, Risk Vs. Return as multiple objectives.
9. Future Worth Analysis; Clean and Green, Future Worth Analysis, Payback period of an investment, Sensitivity and Breakeven analysis. Engineering Education and Sustainable Development.

9. Conclusions

This paper presents development of two courses for teaching sustainability in mechanical design and manufacturing along with modules for teaching. These courses offer integration of life cycle analysis, environmental impact, and end-of-life (EOL) considerations for engineering products. Design and Manufacturing are two core (required) subjects for undergraduate in several

engineering disciplines including mechanical engineering, aerospace, civil, manufacturing and industrial engineering. In-depth coverage of such topics as environmentally friendly material, sustainability, green design of components, the life cycle cost including disassembly, and environmentally conscious manufacturing with examples and homework will prepare our graduates for tackling the sustainability problems of world. It is an attempt to present some ideas for inclusion and modification of Engineering mechanics, Mechanical Design, Design and Manufacturing, and Manufacturing courses to include sustainability considerations.

References

Boothroyd, G., Dewhurst, P., and Knight, W. 2002, **Product Design for Manufacture and Assembly**, Marcel Dekker, Inc, New York, NY, USA.

Yi, H., Park, Y, and Lee, K., 2003, **A Study on The Method of Disassembly Time evaluation of a Product using Work-factor Method**, , IEEE, 1753-1759.

Feldman, K., Trautner, S., Lohman, H., Melzer, K., 2001, **Computer-based product structure analysis for technical goods regarding optimal end-of-life strategies**, Journal of Engineering Manufacturing, Vol.215,683-693.

Lee, S.G., Lye, S.W., Khoo, M.K., 2001, **A multi-objective methodology for evaluating product end-of-life options and disassembly**, International Journal of Advanced Manufacturing Technology, Vol.18, 148-156.

Kroll, E., Carver, B.S., 1999, **Disassembly analysis through time estimation and other metrics**, Robotics and Computer-Integrated Manufacturing, Vol.15, 191-200.

Gungor, A., Gupta, S.M., 1999, **Issues in environmentally conscious manufacturing and product recovery**; a su

Michael F Asby **Material Selection in Mechanical Design**, 2011 Elsevier Ltd.USA

Nand K Jha, **Green Design and Manufacturing for Sustainability**, 2017, Taylor and Francis, USA

Nand K Jha, 2018, Environment, Sustainability, and Mechanical Engineering, 9th International Conference on Engineering Education for Sustainable Development (EESD 2018), June 3-6, Rowan University, Glassboro, NJ.

Engineering Education for a Zero Growth Economy

Gearold R Johnson¹, Ph.D. and Thomas J Siller², Ph.D.
Walter Scott, Jr. College of Engineering, Colorado State University, USA

¹Mechanical Engineering Department

²Civil and Environmental Engineering Department

Gearold.Johnson@ColoState.edu

Abstract

Engineering as a profession and its educational system grew up in parallel with the development of agrarian capitalism, industrial capitalism and finance capitalism. Engineering has participated heavily in the development and growth of fossil fuels both for materials production and as an energy source; land, sea and air transportation systems; manufacturing; communications; computing; the built environment and many others. Engineering has contributed to non-renewable resource extraction and materials innovations as well as developments in the rise and growth of mass industrialization. Now society faces the need for major changes if society is to survive the existential threats it is facing such as biophysical environment degradation, climate changes, health pandemics, and over population. All of these threats are a result of the economics of unlimited growth which is no longer tenable. How will these unknown threats and challenges affect the engineering profession and in particular engineering education? In this paper we will take a brief view of possible impacts to engineering education for the built environment as it could be affected in a zero growth economy. We hope that this paper will inspire and lead others to inspect other disciplines within engineering education for changes and innovations that a sustainable future may require.

Introduction

Is human society's interaction with the Earth's biophysical environment in an unsustainable state? This is a question that is being asked by many today. While there are skeptics and deniers, we accept the preponderance of scientific data that says that society's interaction with the biosphere is in an unsustainable state. For example, data supports environmental degradation through increased pollution in terms of greenhouse gas emissions, loss of biodiversity, both surface and groundwater pollution and the over pumping of groundwater, decreased fossil fuel and other mineral resources; data also supports both economic and cultural degradation from increased income inequality and inequity, over population and overcrowding, the general lack of racial and social justice, food and water insecurity, mass migrations of peoples and global health pandemics. Neoclassical politico-economists believe that continued unlimited economic growth and markets solve all problems. We do not believe this as evidenced by the current state of the biosphere as well as the recent history of the Great Recession of 2008-09. Obviously, unlimited growth is impossible when that growth consumes non-renewable resources and produces waste greater than ecosystems can service. It is time to admit that unlimited economic growth is no longer a viable system and accept a zero-growth, or perhaps even a degrowth, definition for a future sustainable society.

So why is it so difficult to accept zero-growth or degrowth as the future? For one thing zero-growth is considered to be a failure state in many situations. The growth of a country's GDP is what often keeps politicians in power, whether they be in European countries, China or the USA. This is also true for corporations. Rarely does a corporation hire a CEO to reduce a company's size -growth is the measure of success. This concept of growth being equated with success is so engrained in society, a movement to

zero-growth, or degrowth, runs contrary to the fabric of most of society. Engineering is also complicit in this denial. Few engineers are interested in becoming experts at repairing existing artifacts -the attraction of engineering is in the design of something new. Conspicuous production and consumption and ‘designed obsolescence’ require a collaboration between business experts and engineers. There is also a question of social justice around the concept of zero-growth. Shall western societies reap the benefits accrued from years of growth but push developing countries to limit growth to help pay for the developed world’s excesses? But zero-growth is inevitable, the question is not if, but when!

In fact, if we accept Bonaiuti’s analysis (Bonaiuti 2018), and it seems very compelling, the U.S., Europe and Japan are already in an involuntary degrowth situation and China is probably only a decade or two behind (Li 2014). Unfortunately, voluntary degrowth or even zero-growth will not occur in the short-run by the developed nations. This may happen over time as living conditions become increasingly more difficult and even new forms of politico-economic systems may be introduced such as “climate capitalism,” “ecosocialism,” “green republicanism,” or as yet unknown socio-politico-economic-technological systems (Latouche 2009, Kirby 2017, Fremaux 2019).

However, this is all in the future. So, if one of the main roadblocks to a future sustainable state is the question of economic growth then our question is: If the transition to a sustainable society means zero economic growth or even a de-growth scenario, what are some implications for engineering education? Clearly the answer will partially lie in curricula. Engineering curricula has responded to previous major events such as the launch of Sputnik in 1957, but the sustainability crisis lacks that clearly defined ‘moment’ in time that mobilizes a majority of educators.

Of course, engineering education is a hugely complex topic and is only cursorily approached here. Technological development (progress) must be decoupled from economic growth. Most technology advancements that result in productivity gains have always been systematically transformed into greater output rather than reducing the effort required which would result in workers having to work fewer hours. Witness the entrepreneurial movement that emphasizes new products. Changing the outcome from greater output rather than lessening workload is a change in mindset. This change will be very difficult for many engineering faculty members to accept and thereby address in their classes. And there are other mindsets holding engineering education back. For example, few engineering programs emphasizes the depth of interdisciplinary effort that is required to effectively work towards a sustainable future. Engineers maintain a mindset that they are ‘the problem solvers’ instead of members of much, much broader teams (Siller, Johnson et al. 2016). Engineering has always suffered from a lack of an underlying philosophical basis. A sustainable future may force engineering to adopt a new ontological and epistemological underpinning. (Siller, Johnson et al. 2018)

In the next section we will look at an example of changes that could take place in civil engineering with respect to maintaining the built environment.

The Built Environment Example

The meaning of a zero-growth, or degrowth society, changes the meaning of the world of the built environment. Most engineering education focuses on the design and implementation of new artifacts. Rarely does engineering education focus on the reuse of existing artifacts. Yes, there are recycle programs everywhere, but too little effort is spent on the refurbishment of existing artifacts. This is especially true of the built environment such as buildings, roads, and bridges. As growth halts, the need for different types of facilities does not go away but the effort should shift to existing structures, not new ones. Existing buildings need to reduce current energy use, roads and bridges will need to accommodate modern, energy efficient vehicles. To reduce the consumption of non-renewable materials existing

facilities should be refurbished instead of building new facilities. Existing building need to be considered resources not waste to be eliminated.

The majority of engineering education programs, at least in the U.S., continue to focus on designing new artifacts. The lack of formal education programs for refurbishment was recognized early in this century, as articulated in the preface of the CISM course on refurbishment describing the reason for the course "... in view of the relatively scarce availability of similar advanced educational programs in regular courses held at university," (Mazzolani et al., 2002).

Underlying the need for education about refurbishing of existing facilities is the implicit acknowledgement that this type of engineering work requires technical skills beyond that found in traditional curricula. Mazzolani (Mazzolani 2002) discusses topics such as material compatibility between existing building materials and new materials being considered for refurbishment. While many engineering materials related courses focus on basic strength and deformation properties. Mazzolani also discusses system-level approaches not typical to new design, such as the need for new building additions to be reversible, i.e. additions that can be removed if necessary. These types of systems engineering processes are still lacking in most curricula. Further, he presents a classification of refurbishment starts with safeguarding of structures -this is already a temporary technique with regards to safety issues. His second classification, repair, is also a common technique to maintenance engineering functions, but his other two classifications are related to our concern of retrofitting existing building for a new future: reinforcing and restructuring for new purposes. These latter two are what is needed for a zero-growth future. Both of these approaches serve the purpose of continuing the use of a structure either for its original intention but possibly expanded, and the latter is effectively the 'reuse' of the building for a new purpose. Either way, the result is using existing facilities instead of the more common tear down and build new approach.

Before moving to examples that require new technical skills it is worth mentioning how existing skills can be used along with a different design philosophy to make it easier to use existing facilities. Both of these examples come from Hill and Martinez-Diaz (2020). The first case involves a rail corridor in southern California, United States. The pylons were strengthened such that the bridges could be raised if future flooding became worse. A second case involves Dutch seawall construction. The foundations for the seawalls were over-built such that if future sea level rise is larger than planned, the structures can be safely raised. Both these examples do not require new skills but a new mindset -build for now and include flexibility to adapt in the future. These examples show how flexible design can better allow for adaptation later instead of replacement being the norm.

As an example of the need for technical skills in the world of refurbishment, we look first at the area of building foundation engineering. The second author of this paper has taught the topic of foundation engineering numerous times over his 32-year career in academia. Upon reviewing the materials in the CISM course related to foundation refurbishment (Mandara 2002) it became clear that the techniques discussed were not topics commonly covered in foundation engineering courses. This is supported by the lack of coverage in popular textbooks in the U.S. for foundation engineering such as (Das and Sivakugan 2017). Of the three techniques covered by Mandara (Mandara 2002), underpinning, base widening, and soil improvement, only soil improvement is discussed by Das and Sivakugan (2017). And soil improvement in the textbook focuses on new construction and not on refurbishment of existing structures. The techniques of implementing soil improvement for existing structures entails very different technical aspects. New construction generally allows for easy access to implement techniques as no existing structure is in place to block access. To improve soil below and existing structure using techniques such as grouting often requires drilling through the base of existing foundations (Mandara 2002). Engineering students are not taught techniques for soil improvement that may require potentially compromising the

integrity of existing foundations. The intermediate stage where the existing structure is temporarily compromised before the final improved state presents different challenges than new construction.

The other techniques for refurbishment, underpinning and base widening require techniques not even hinted at in the traditional curricula/textbooks. Again, these techniques create temporary risky situations where current systems have to be supported while additional structural elements are added to the system. Undergraduate engineering education presents problems that start with a clean starting point. Students are not prepared to deal with complex existing systems.

There is some good news in terms of the profession moving forward in the direction of modifying existing buildings. An encouraging recent trend has been the retrofitting of large skyscraper buildings. As stated by Al-Kodmany (Al-Kodmany 2014) there are advantages to retrofitting the existing building stock than tearing down and building new "... renovating older buildings could be 'greener' than destroying them and rebuilding new ones. While some demolition and replacement may remain a necessity to meet contemporary needs, there are significant opportunities to reduce carbon emission and improve existing buildings' performance by retrofitting them rather than constructing new ones." Similar to Mazzolani, Al-Kodmany also recognizing that the skills of engineers must also change:

"Overall, required technical expertise on the part of the project team—architects, engineers, building managers, tenants and energy service companies—continue to be lacking."

A key methodology for restoring existing buildings is to reduce energy use. (Ma, Cooper et al. 2012) This is one area where new and refurbished structures are similar -efficient energy use is a goal of both. But again, similar to foundation engineering, in existing buildings, installing new energy systems may require very different design approaches than the clean slate of a new structure. The first large building to attain LEED Gold certification due to retrofit or refurbishment was the Empire State Building in New York City, New York, USA. (USGBC 2020) This certification was obtained in part due to increased energy and water use efficiency. But this is only one success story with skyscraper retrofits. According to Al-Kodmany the following buildings, in addition to the Empire State Building, had made significant changes as of 2014

- Willis Tower, Chicago, IL, USA: recently became the tallest building to get Energy Star designation meaning it uses at least 35% less energy than a typical building
- Taipei 101, Taipei, Taiwan: earned LEED Platinum certification
- Adobe System Headquarter Complex, San Jose, CA, USA: retrofit included upgrades to reduce both energy and water use
- Glastonbury House, London, UK: retrofit led to 50% in energy saving and 40% in water reduction
- The Joseph Vance Building, Seattle, WA, USA: heating, lighting, and water systems all upgraded
- Hanwha Headquarters, Seoul, Korea: the proposed changes for this building include the façade replacement.

Each of these could form the basis of a case study for new courses in civil engineering.

Conclusion

We, engineers, have played a significant instrumentalist role in the current biophysical environment crisis and any changes in engineering education must start with a thorough examination and reflection on engineering's role in the creation of a sustainable society. This requires a close examination of engineering education through the lens of zero growth. Design courses need to be altered to emphasize

renovation rather than always designing something new. Engineering students should be taught the value of embodied carbon, embodied energy, embodied water and materials and embodied culture. We should also emphasize innovation combined with entrepreneurship focused on social, cultural and environmental entrepreneurship rather than economic entrepreneurship. Our students also need to learn about complex open systems to understand how technological interventions need to be continually adapted within a changing system. The paper provides an initial examination of engineering curricula intended to identify what we include in our curriculum that aids or hinders the required transition to a sustainable society.

References

- Al-Kodmany, K. (2014). "Green Retrofitting Skyscrapers: A Review." Buildings 4(4): 683-710.
- Bonaiuti, M. (2018). "Are we entering the age of involuntary degrowth? Promethean technologies and declining returns of innovation." Journal of Cleaner Production 197: 1800-1809.
- Das, B. M. and N. Sivakugan (2017). Principles of foundation engineering 9e. Boston, MA, Cengage.
- Fremaux, A. (2019). After the Anthropocene: Green Republicanism in a Post-Capitalist World. Switzerland, Palgrave Macmillian.
- Hill, A. C. and L. Martinez-Diaz (2020). Building a resilient tomorrow : how to prepare for the coming climate disruption. New York, NY, United States of America, Oxford University Press.
- Kirby, P. (2017). The political economy of the low-carbon transition : pathways beyond techno-optimism. New York, NY, Springer Berlin Heidelberg.
- Latouche, S. (2009). Farewell to Growth, Polity Press.
- Li, M. (2014). Peak oil, climate change, and the limits to China's economic growth. New York, Routledge.
- Ma, Z., P. Cooper, D. Daly and L. Ledo (2012). "Existing building retrofits: Methodology and state-of-the-art." Energy and Buildings 55(December): 889-902.
- Mandara, A. (2002). Strengthening Techniques for Buildings. Refurbishment of Buildings and Bridges. F. M. Mazzolani and M. Ivanyi. Vienna, CISM: 196-264.
- Mazzolani, F. M. (2002). Principles and Design Criteria for Consolidation and Rehabilitation. Refurbishment of Buildings and Bridges. F. M. Mazzolani and M. Ivanyi. Vienna, CISM: 1-60.
- Siller, T., G. Johnson and R. Korte (2018). Engineering as problem solving: A need for a different approach. fPET 2018, fPET 2018.
- Siller, T. J., G. R. Johnson and W. O. Troxell (2016). What Do Sustaining Life and Sustainable Engineering Have in Common? New Developments in Engineering Education for Sustainable Development. W. L. Filho and S. Nesbit. Switzerland, Springer International Publishing: 273-282.
- USGBC. (2020). "Empire State Building Achieves LEED Gold." Retrieved 9 February, 2020, from <https://www.usgbc.org/articles/empire-state-building-achieves-leed-gold>.

A Novel Pedagogical Approach to Teaching Climate Change and Ethics

A. Kahl¹

¹College of Engineering, Penn State Greater Allegheny, McKeesport PA USA

afk12@psu.edu

Abstract

Climate change is not only a political, economic, and social crisis, it presents one of the great moral problems of our time. This paper describes an introductory course that describes the science, policy, and ethics of climate change. This course uses the novel pedagogical approach of integrative studies to provide students the tools to understand the basic science of climate change and its ethical implications. Students will come away with a better sense of the moral dimensions of this phenomenon and the implications for human civilization and for the biosphere. Integrative studies courses are co-listed in two education domains, which serve to give students a broader perspective than a single domain course. This course is co-listed in the domains of general sciences and humanities.

As a general sciences course, students must be able to explain the methods of inquiry in the various climate science fields; demonstrate informed understandings of scientific claims and their applications; and evaluate the quality of the data, methods, and inferences used to generate scientific knowledge about climate change. Students will demonstrate their mastery of these concepts through participation in class discussion, acceptable achievement on quizzes and homework and on the first unit exam.

As a general humanities course, students must be able to explain the methods of inquiry in ethics, demonstrate competence in critical thinking about topics such as human interaction with nature and the value of human and ecological flourishing, and critically evaluate class texts, especially their ethical dimensions. Students will demonstrate their ability to incorporate the knowledge of climate science into an ethical analysis through homework assignments and through conducting and reporting on an ethics conversation.

Integrative learning objectives will be emphasized throughout the class, but a final climate negotiation project will allow students to apply their knowledge of climate science and ethics to a specific country context. Together, teams of students will engage in a mock climate negotiation in the final week of class.

1 Introduction

1.1 Course structure

Students who enter this course come from a variety of backgrounds and majors, as well as a variety of college standing (1st-8th colligate semesters). Some students are first semester freshmen, while others are seniors completing their final course requirements. This course gives students a basic understanding of energy and energy usage as well as engaging with current questions about climate, weather and climate change through the lens of ethics. As students come from a variety of backgrounds, both in college coursework/preparation and in science literacy, it is a challenge to engage the entire class in discussion and dissection at a sufficiently challenging yet not unreachable level. In order to meet this challenge, I approach the course from the perspective of scientific inquiry, based on Harwood (2003). By initially introducing the class to the scientific inquiry process, I provide students a framework with which to fit existing knowledge and to place new knowledge. The central graphic for the course is the wheel of scientific inquiry, shown in Figure 1.



Figure 1: Activity model for scientific inquiry

Similarly, the coursework is structured such that it follows the wheel of scientific inquiry through the progression of course topics. The course begins by exploring the observations we have made with respect to weather and climate, for example, by asking students to research an extreme weather event and present their findings in the form of a discussion post or course presentation. Through this lens, students are invited to consider the relationship between these events and changing climate. Once they begin to see the linkages between current events and the larger picture of climate change, they are asked to think about what we know and what might be responsible for this, leading to the second focus of the course on ethics. Students then “investigate the known” by learning about energy and energy usage from a global perspective, then narrowing to the national picture, then narrowing further to the local energy portfolio. By starting students with the global perspective, it helps them to place their learning in context.

A similar pathway is followed for all ethical discussion. Students are invited to read a paper by Greg Jenkins which details the prediction and effects of Hurricane Fred in 2015. The conclusion of the paper outlines

lessons learned following the devastating hurricane on Cape Verde, which include challenges in communication and preparedness given the diverse socioeconomic population of the island. Students are asked to discuss the ethics involved in effective communication, both before and after extreme weather events and to consider the implications of ethical behavior. In this way, students both “observe” and “reflect on the findings.”

2 Projects

2.1 Project focus: Living Room Conversations

To bring together student learning about climate change and ethics, students engage in Living Room Conversations using the summary for policy makers from the latest IPCC report. A Living Room Conversation bring together between four and six individuals (ideally six) to host a meaningful conversation about an issue, where the focus is learning from one another and being open and curious, rather than debating the issue. Two students serve as hosts and each invites two other individuals to be part of the conversations. Living Room Conversations can take place anywhere, including via virtual tools like Zoom. The hosts come up with 2 well-researched facts and 5 open-ended, inclusive questions that they want to know the answer to that can lead into the relationship between people's values and thoughts about climate change. Some of these questions can be detailed, but there should be at least 2 large-scale open questions. To begin the conversation, students start with start with open discussion about their values before concentrating on climate. For the facts, students are required to cite peer-reviewed publications, using the IPCC summary as a jumping off point. The Living Room Conversation is an open-source, non-profit project that was founded in 2010 with the aim of create a structured, intimate conversation format that would empower everyday citizens to discuss important issues with friends of differing political affiliations and backgrounds. The theory was that if two friends with different points of view, each invited two friends to join a conversation, with full disclosure about the intent and structure of the conversation, they could create a safe space for a respectful and meaningful exchange of ideas, develop new relationships and perhaps find common ground. Students utilize the Living Room Conversations as a way to synthesize their learning of both climate and ethics while engaging others in discussion. Student feedback related to this portion of the course included the important reflection: “I also liked that she had us doing this type of hands on activity in class. I feel that because she did that it made it much more fun to learn.” Students rated the effectiveness of the course in stimulating further explorations of the subject matter outside of class as 6.63 on a 1-7 scale, indicating that this activity was effective.

2.2 Final project: Mock Climate Negotiation

The final for the course is a mock climate negotiation. Based on the Paris climate negotiations, students organize themselves in groups of four or five to represent a country that is not the United States. This exercise takes place in over two class sessions. During the initial session, students are reconfigured into five groups, so that all the ministers of culture are sitting together, all the ministers of environment, the ministers of energy, foreign ministers, and industry reps. The goal for this session is to have an open discussion without the pressure of negotiation. Each country presents its particular situation regarding energy, culture, etc. and then they should talk about 1) what useful information is missing about their country, and 2) how their particular portfolio intersects with carbon reduction goals for their country. The

purpose here is to mimic the actual international process by which countries prepare for international organizations. To prepare for these negotiations, students complete and submit a short research paper of approximately 900 words. The subject of the research paper will depend on a) the chosen country and b) the students' administrative "portfolio." The job of the student is to understand their country's commitments under the Paris accord and how they fit into that country's overall goals. In other words, students are trying to understand what each country thinks are economically viable, technically feasible, and ethically important. For example, if a student chooses to represent the energy minister for China, they will want to know China's energy needs, current mix of energy production, and specific plans for renewable energy in the future. The research paper should include authoritative data from peer-reviewed sources (such as the IPCC reports) as well as analysis of those data. Following this class session, the mock negotiation is held. Each delegation is allowed 1-5 minutes (as determined by the moderators) to present a poster with its three main goals for the negotiation. The moderator will invite responses to the stated goals from other delegations; only those recognized may speak. Following presentation, students expected to engage in bilateral and trilateral negotiations with representatives from the other countries. Together they must join with other countries to generate a PowerPoint slide or two, which details how they intend to reach their CO2 reduction goals and justifications. Following creation of these slides, students sit in their multi-country blocs and present the results of multi-lateral negotiations. Delegations are allowed 1-5 minutes (as determined by the moderator) to present their PowerPoint slides. After the first presentation, non-represented countries will vote either to discuss or to move on to the next presentation. At any time, points of conflict will be identified by the moderators and resolved using the Indaba Technique: "huddles" will be established by naming representatives who will discuss (others may join and observe, but may not speak). Objections must include positive alternatives. At the close of negotiations, results are binding and a new "accord" is generated. This exercise is a great close of the course as students must utilize their learning of both climate and ethics along with civil discourse to follow a dialogue that mirrors real world processes. Student feedback included the important quote : "The final climate negotiation helped me to really understand the positions of each country and how climate change affects everyone." Students rated the effectiveness of the course in improving critical thinking skills as 6.50 on a 1-7 scale, indicating strong agreement with the evaluation statement.

3 Conclusion

This paper presents a brief outline of a novel pedagogical approach to teaching climate change and ethics through an integrative studies course. Students use the wheel of scientific inquiry to fit existing knowledge with new knowledge to broaden their understanding of topics in both climate and ethics. As part of the course, students synthesize their learning through two major projects; a mid-semester Living Room Conversation and the final climate negotiation. This approach is unique in pedagogy by providing students with the tools to explore the moral dimensions of climate change and the implications for human civilization and for the biosphere.

References

Harwood. 2003. *National Science Teaching Association*.
<https://www.nsta.org/publications/news/story.aspx?id=48890>

Embedding Sustainability across the Built Environment Curriculum and Beyond

M.Kelly¹

¹Department of Building and Civil Engineering, Galway-Mayo Institute of Technology, Dublin Road, Galway, Republic of Ireland

Mark.Kelly@gmit.ie

Abstract

This study will outline progress of an ongoing Teaching and Learning Engineering Innovation project in the Department of Building and Civil Engineering at the Galway-Mayo Institute of Technology, which has employed incremental diffusion approaches to embed sustainability as a core threshold concept across all degree programmes. Phase 1 involved undertaking a curriculum review of all programmes in the Department to identify opportunities to embed sustainability in programme and curriculum design, particularly focusing on constructively aligning learning outcomes, graduate attributes and competences to pedagogy and assessment strategies. This was followed by the design and piloting of a questionnaire survey, which was disseminated to all students within the department to identify pro-environmental attitudes, self-reported behaviours, social and moral norms etc. A reciprocal learning framework encompassing curriculum and pedagogical experimentation, ongoing collaborative industry research on resource efficiency and the circular economy, the ‘living lab’ campus and other initiatives associated with the Green Campus programme is under development in phase 2. This paper will present findings from a selection of experimental interventions tested in phase 1 with students on the B.Sc. in Construction Management and the B.Sc. in Quantity Surveying and Construction Economics where complexity, ‘wickedness’, reflexivity, personal and professional identities and possible futures were debated and discussed. This is informing the development of an educational framework to facilitate a transition within the Department to move from learning ABOUT sustainability (accommodative) using narrow ‘bolt-on’ discipline-specific approaches to learning FOR sustainability (reformative) where the campus operations, curriculum and institute policy begin to be reconceptualised to capacity-building learning AS sustainability (transformative) (Sterling et al., 2013) through experiential learning communities of practice that aim to bring about whole institutional change.

1 Introduction

The role of education as a catalyst towards re-imagining and creating conditions for possible sustainable futures has received considerable attention over the past two decades, with the United Nations Educational, Scientific and Cultural Organization (UNESCO) declaring 2005 to 2014 as the International Decade of Education for Sustainable Development (DESD). This initiative defined Education for Sustainable Development (ESD) as ‘a vision of education that seeks to balance human and economic well-being with cultural traditions and respect for the Earth’s natural resources’ using inter- and transdisciplinary lifelong learning approaches. In Ireland, this decade of ‘action’ largely passed the Higher Education sector by, with the exception of pockets of good work, most notably by Dublin City University¹ (DCU), University College Cork² (UCC),

¹ DCU were a project partner on a funded Tempus RUCAS (Re-orientating University Curricula to Address Sustainability) project, which involved 11 universities within the EU and Middle East.

² In 2007, UCC students instigated a pilot Green Campus programme, with the help of An Taisce, which would see the university become the first in the world to be awarded a Green Flag from the Foundation for Environmental Education. In 2016, UCC published its Sustainability Strategy, which is student-led, research-informed and practice-focused. In 2018, UCC became the first university in Europe to be awarded a Gold Star from the Association for the Advancement of Sustainability in Higher Education.

Galway-Mayo Institute of Technology (Mayo³ and Letterfrack campuses) and other Green Campus Programme participants. The national framework for sustainable development in Ireland, *Our Sustainable Future* (DoECLG, 2012) did refer to 'sustainable education', recommending a focus on: environmental issues (climate change, disaster risk reduction, biodiversity, environmental protection, natural resource management, urban decay, water security); socio-economic issues (economic growth, poverty, food prices, child labour, social exclusion, justice, debt-security, human rights, health, gender equity, cultural diversity, production and consumption patterns, corporate responsibility, population growth, migration); and political issues (citizenship; peace; ethics; human rights; democracy and governance).

Following on from this, one notable achievement was the publication of a *National Strategy on Education for Sustainable Development (ESD) 2014-2020* by the Department of Education and Skills in 2014⁴. The objective of this strategy was to 'ensure that education...equips learners with the relevant knowledge, the key dispositions and skills and the values that will motivate and empower them throughout their lives to become informed citizens who take action for a more sustainable future.' Higher education was identified as a priority action area where 'disciplinary silos, a lack of specific ESD content and concerns about the preparedness of lecturers to facilitate the type of participatory learning that is required for effective ESD' were identified when attempting to take a whole institution approach (Department of Education and Skills, 2014). Subsequent international initiatives such as the UNESO (2014) *Roadmap for Implementing the Global Action Programme on ESD* and the *Education for Sustainable Development Goals (SDGs) Strategy* (UNESCO, 2017) have continued to inform holistic and transformational ESD approaches in the higher education sector. Interestingly, the recently published *Higher Education System Performance Framework 2018-2020* (HEA, 2018) and the *Sustainable Development Goals National Implementation Plan 2018-2020* (DCCAE, 2018) specifically refer to ESD under the evolving policy context, future challenges and focus sections. The most recent policy development has been the publication of the *Climate Action Plan* in 2019 (Government of Ireland, 2019), which again has highlighted the role of higher education in the (so-called) 'Just Transition' and in the provision of courses and modules related to agriculture, land use and climate change. Several construction-related actions mainly focusing on reducing energy use, decarbonising the building stock, the greater use of lower-carbon building material alternatives and upskilling industry stakeholders in deep retrofit were also listed in the *Climate Action Plan*, which in turn should inform curriculum development in higher education.

This paper will outline progress to date of an ongoing Teaching and Learning Engineering Innovation project in the Department of Building and Civil Engineering at the Galway-Mayo Institute of Technology, particularly focusing on some example experimental learning interventions employed in two final-year modules on the B.Sc. in Construction Management and the B.Sc. in Quantity Surveying and Construction Economics.

2 The Challenges facing the Construction Sector and the Role of Higher Education

The built environment, on a global scale, is on track to double building-related carbon emissions by 2050 (World Green Building Council, 2019), with steel and cement production jointly responsible for approximately 15-20% of global generated emissions (UN Environment, 2019). Global resource use is also predicted to double by 2030 (UN Environment, 2017), which aligns with the population projection of eleven billion plus by the end of the twenty-first century (UN Environment, 2019). Recent estimates (2017) suggest that buildings' construction and operations account for 36% of global final energy

³ The GMIT Mayo campus was the first Institute of Technology in the world to be awarded the status of Green Campus by The Foundation for Environmental Education (FEE) and An Taisce in 2011 and GMIT Letterfrack was awarded an Green Campus Flag by An Taisce in 2014 and 2019.

⁴ The National Strategy is currently under review.

use and 39% of energy-related carbon dioxide (CO₂) emissions. In the EU, more than 50% of all extracted materials (approximately three billion tonnes) and 30% of all our water consumption is related to the construction and use of buildings, with over 800 million tonnes of construction and demolition waste (CDW) produced each year (including soil), which represents two tonnes generated for each European citizen. In Ireland, there has been a clear correlation between construction output and CDW production, with estimates of 17.8 million tonnes (Mt) in 2007 (EPA, 2009) dropping to just over 3Mt in 2014 (EPA, 2018), mirroring the dramatic economic growth and subsequent sharp decline over that period. Preliminary data from the EPA in 2016 suggests that CDW production is on the rise again in Ireland as construction output improves. This clearly demonstrates the enormous challenges facing the construction sector in the coming years particularly relating to higher energy costs; climate change mitigation and adaptation; a rapidly growing world population; the depletion of natural resources; the level of toxicity in a building's lifecycle; increasing air and water pollution; growing levels of waste as well as local and global societal issues such as poverty, war, famine etc. (Kibert and Grosskopf, 2008 cited in Hayles and Holdsworth, 2008). Traditionally, the sector has viewed environmental management as an extra cost burden in a highly competitive industry, with supply chain stakeholders reluctant to undertake actions voluntarily for fear of losing competitiveness; this can be especially true amongst SMEs. So, what role can higher education play in rethinking the built environment sector to imagine a future that will move beyond just doing less harm to the environment towards one which has net positive environmental benefits. Societally and within the built environment sector, this will mean a move away from unsustainable drivers such as anthropocentrism, resource extraction, consumerism, human population growth and wealth generation orientated towards short-term profits (Lozano-Garcia et al., 2008) to embracing integrated systems approaches such as the: deconstruction of buildings and the use of reusable components and recycled materials within a circular economy; employment of passive or energy positive design with appropriate renewable technologies and excellent indoor environmental air quality; and natural ecosystem integration including optimised hydrological cycles (Graham, 2000; Kibert and Grosskopf, 2008), to name but a few. This will require a transformative and interdisciplinary integration of knowledge, insights, skills and practices from divergent disciplines to generate the radical or disruptive strategies or technologies that will shift systems of production, provision and consumption and open up new possibilities (Metzger and Zare, 1999). The complexity of these issues require a new form of thinking grounded in environmental literacy described by Orr (1992 cited in Hayles and Holdsworth, 2008) as:

'...the knowledge necessary to comprehend inter-relatedness; an attitude of care and stewardship; and the practical competence to act on the basis of knowledge and feeling.'

Orr (1992 cited in Hayles and Holdsworth, 2008)

Barth et al. (2007) and Filho (2009) highlight the potential role that higher education can play in implementing sustainable development by providing a link between knowledge generation and knowledge transfer through societal and industrial outreach and engagement and the education of potential future decision-makers. Interestingly, efforts to embed sustainability into the built environment curriculum seems to have had mixed results. Wang (2009) suggests that it is widely accepted that sustainability should be incorporated into engineering education, but Jung et al. (2019) found that environmental concern and sustainable consumer behaviour scores were significantly less for built environment students in the US who had completed a course in 'Green Building and Sustainable Construction' than those who had not. In contrast, Bielefeld (2011) found that first-year students who completed an environmental engineering module (as opposed to a civil engineering module) had greater knowledge and more positive attitudes towards sustainability. In addition, there was strong evidence that students considered sustainability in subsequent course assignments, even when not specifically asked to do so. Murray and Cotgrave (2007) suggested that sustainability literacy was a future paradigm for construction education and that it was readily achievable within existing courses and modules. To support the embedding of sustainability literacy as a core competency in construction-related courses, Cotgrave and Kokkarinen (2010) developed a framework focusing on

learning outcomes and the holistic integration of project-based approaches across the selected programmes, which when tested (Cotgrave and Kokkarinen, 2011) found that participating students believed it was important to inform clients of the environmental impact of proposed works and to build in an environmentally-friendly way. This was further supported by students' reflective feedback on their experience and understanding, which highlighted a perceived improvement in attitudes towards sustainability (Kokkarinen and Cotgrave, 2013).

3 Project Overview and Methodology

In 2018, the School of Engineering in GMIT invited academic staff to submit proposals under a Teaching and Learning Innovation initiative open call focusing on any aspect of academic practice. The author successfully applied for funding for a three-year project entitled 'Embedding Sustainability across the Built Environment Curriculum and Beyond'. The main aim of the project is to: develop an educational framework to facilitate a transition from learning ABOUT sustainability (accommodative) using narrow 'bolt-on' discipline-specific approaches to learning FOR sustainability (reformatory) where the campus operations, curriculum and institute policy begin to be reconceptualised to capacity-building learning AS sustainability (transformative) (Sterling, 2013) through experiential learning communities of practice to bring about whole institutional change. This proposal is employing an incremental diffusion approach with Phase 1 initially focusing on the two undergraduate programmes in the Department of Building and Civil Engineering. Phase 2 will seek to engage more broadly with the suite of programmes in the Department of Building and Civil Engineering by working with staff who have already expressed an interest in piloting the interventions on different modules in Years 1 to 4. It is envisaged that other snapshot pilots will also be carried out in other disciplines facilitated through the Education for Sustainability⁵ elective module on the M.A. in Teaching and Learning Programme and the Green Campus initiative⁶. Phase 3 intends to share the lessons learned, evidence-based practice and reusable learning resources across all disciplines using organisational learning and educational open-source principles to demonstrate how to move from just from learning about sustainability to actively engaging in sustainable education itself. The project is utilising Rusinko's (2010) generic matrix for the integration of sustainability into higher education (Figure 3.1) The four quadrants provide different options for integration into existing or new curricula i.e. using either existing courses and structures (quadrants I and III) or developing new courses and structures (quadrants II and IV). Previous work has demonstrated multiple examples of using each of the four approaches i.e. Rameriz (2006), Svanstrom et al., (2012), Stubbs and Cocklin (2008), Blizzard et al. (2011) in Quadrant I; Buchan et al. (2007), Stubbs and Schapper (2011), Down (2006), Barth and Rieckmann (2012) in Quadrant II; Hayles and Holdsworth (2008). Hopkinson and James (2010), Wilmot (2009) in Quadrant III; and Rusinko (2010), Ferrer-Balas et al. (2008), Savelyeva and McKenna (2011), Dobson and Tomkinson (2012), Barth et al. (2007) Menoni (2006), Mieg (2006), Muhar et al. (2006), Stauffacher et al. (2006) in Quadrant IV.

The integration of sustainability can be situated in one quadrant or in multiple quadrants simultaneously. Lozano et al. (2006) does recommend an incremental approach where the initiative can be trialled and tested and if 'successful' can expand throughout the department or school. An example of this would be when working within quadrant I, which would cause the least disturbance to the existing structure as it would involve the integration of sustainability themes or case studies into existing modules while remaining consistent with module descriptors, content and learning outcomes. The move to quadrant II to develop a dedicated stand-alone module within an existing course has been met with some criticism. Sterling (2004) calls this process 'bolting-on' while Rusinko (2010) points out that this approach may isolate sustainability if it is not incorporated into the core curricula (Shriberg, 2002, Stubbs and Schapper, 2011). This would fit in with the existing

⁵ The 'Education for Sustainability' elective module was developed by the author to offer a structured CPD option to staff in GMIT as part of a suite of module on the M.A. in Teaching and Learning.

⁶ The author is also the GMIT Dublin Road Green Campus Chairperson.

mechanistic model of higher education that divides understanding into separate boxes (Segalas et al., 2012). Quadrants III and IV have a cross-disciplinary focus with quadrant III focusing on common core modules across disciplines. Quadrant IV is the most challenging with its cross-disciplinary (two or more disciplines) or transdisciplinary approach (including industry stakeholders and citizens). It is clear that a new pedagogical approach is required to encourage ‘deep learning’ (Warburton, 2003) and ‘transformative change’ (Sipos et al., 2008) to address the complexity that is inherent in sustainability.

		SHE delivery	
		Existing structures	New structures
SHE focus	Narrow (discipline-specific)	I. Integrate into existing course(s) minor (s), major (s), or programs(s)	II. Create new, discipline-specific sustainability course(s), minor(s), major(s) or programs(s)
	Broad (cross-disciplinary)	III. Integrate into common core requirements	IV. Create new, cross-disciplinary sustainability course(s), minor(s), major(s), or programs(s)

Figure 3.1 Rusinko’s (2010) generic matrix for the integration of sustainability into higher education

4 Embedding Sustainability into the Built Environment Curriculum

The Department of Building and Civil Engineering has four Level 8 undergraduate programmes in Architectural Technology, Civil Engineering, Construction Management and Quantity Surveying and Construction Economics and an industry focused two-year part-time Level 8 Higher Diploma in Engineering in Building Information Modelling (BIM). An initial review of the programmes⁷ found that different iterations of ‘sustainability’ (energy, waste, water, carbon etc.), are already embedded into some existing modules, particularly those related to construction technology, building design and performance. A stand-alone 10-credit elective module, ‘Environmental Management in Construction’ is also available to all students in Year 2. In Year 4 of the Construction Management programme, there is a dedicated 10-credit module on ‘Resource Efficiency Strategies for the Construction Sector’ and sustainability is a core theme in the final-year module, ‘Integrated Project’ on the B.Sc. in Quantity Surveying and Construction Economics. It is these two final-year modules that are currently forming the testbed for a range of learning interventions. This paper will focus on the use of STEEP analysis, journal clubs and back-casting as experimental learning interventions within a Quadrant I framework.

⁷ A detailed curriculum and pedagogical review is currently ongoing as part of a programme review process in the Institute during the 2020 academic year.

4.1 Overview of STEEP analysis, journal clubs and back-casting

Social, Technological, Environmental, Economic and Political (STEER) analysis⁸ has been used widely in several construction and sustainability-related foresight studies as it provides a methodology to examine drivers and trends that may influence or impact the unit or theme under investigation. For example, the UK Department of Business, Innovation and Skills (2008) used STEER to frame how the UK built environment could evolve towards a more secure, sustainable low carbon sector that still meets individual and societal needs and economic requirements by 2050. The STEER approach was also used in a New Zealand study by BRANZ entitled *Building the Future—Four Visions of the New Zealand Built Environment in 2025* (Bates and Kane, 2009), which highlighted the key forces in both the local environment and macro environment.

Linzer (1987) and Thompson (2006) provide a detailed historical overview on the background of journal clubs from its initial conception by Sir William Osler as a way of distributing unaffordable periodicals (Rich, 2006) to its extensive use as an educational tool in the fields of medicine, surgery (Horneff et al., 2010), psychiatry (Swift, 2004), nursing (St. Pierre, 2005; Rich, 2006), pharmacy (Clements and Trompeter, 2011), obstetrics and gynaecology, paediatrics and geriatric social service (Linzer, 1987). Although journal clubs have been predominantly used in medical and healthcare education, there is huge potential in their application as a pedagogical tool across all disciplines. Newswander and Borrego (2009) detail their use in the engineering field as a key ingredient in the cultivation of a community of practice at graduate level. A review of previous research (Hammick, 1995; Burnstein et al., 1996; Klapper, 2001; Dirschi et al., 2003; Hall, 2006; Golde, 2007; Walker et al., 2008) identified the following benefits: encourages criticism and creativity; facilitates familiarity with current literature; builds confidence in presentation skills; practical discussion of publication standards; learning from ‘experts’; and peer mentoring and teaching.

A popular scenario methodology employed by the Dublin Institute of Technology (DIT) Futures Academy (Ratcliffe, 2000; Ratcliffe and Sirr, 2003; Ratcliffe and Krawczyk (2004, 2011) and others (Lovin, 1976 and 1977; Robinson, 1982 and 2003; Carlsson-Kanyama et al., 2003; Quist, 2007; Phdungsilp, 2011) has been the back-casting approach. Back-casting has emerged from normative forecasting (Jantsch, 1967) and *La Prospective* (Godet, 2000) methodologies. The aim is to provide a counterpoint to forecasting approaches that are projective in nature using trend extrapolation and historical data. Instead, back-casting starts with an image of the future and then traces its origins and development path back to the present. The future desirable or undesirable image(s) is particularly useful when applied to complex problems where dominant trends exist requiring a major change (Dreborg, 1996). The time horizon and scope of the back-casting approach should allow for the development of radical alternative options (Quist, 2007).

4.2 Use within the curriculum

Traditionally, when covering definitions of sustainability in the modules listed, the following Brundtland statement was put forward as the most widely accepted definition of sustainability.

‘Sustainable development is development that meets the needs of the present without compromising the ability of future generations to meet their own needs.’

Brundtland (1987)

The author realised that a more in-depth analysis was required into the sustainable development concept so that students may begin to understand the complexity involved and to address the competencies required (anticipatory/foresighted

⁸ Is often also referred to as PEST (Politics, Environment, Social and Technology) or PESTLE (Politics, Economics, Social, Technology, Legal and Environmental).

thinking, systematic/critical thinking) to address the interdependency of sustainability issues. It was decided to use the STEEP analysis approach as it is consistently used in foresight and scenario planning work in combination with a Journal Club, where relevant journal papers were reviewed each week. This new learning intervention consisted of the following steps:

Week 1 – Prior to the start of class, each student was asked to complete the Green Campus survey, which explores pro-environmental attitudes, knowledge, self-reported behaviours, social and moral norms, perceived behavioural control and behavioural intentions⁹. At the start of class, each student was asked to write down on a post-it, a set of five keywords related to their understanding of sustainability. The post-it's were collected and displayed on the whiteboard for later discussion. Students were then asked to purchase (in groups of 2) a newspaper each (Irish Times, The Irish Independent or The Guardian) and bring it back to class. Each group was directed to select articles that they thought could be categorised as covering general social, technological, environment, economical and political issues of the day. These articles were cut out and posted to the walls under the five headings. Each group was asked to explain their selection and why they placed their articles in the different categories. A discussion was facilitated to highlight the interrelationships between the five themes and their relationship to sustainability as they understand it i.e. as outlined in the keywords on the post-its. At the end of class, each student was asked to select two articles from any newspaper during the subsequent week that addressed a sustainability and a construction sector issue.

Week 2 – Each student posted their selected articles on the walls under the STEEP headings, 'defending' their selection. The facilitated discussion again focused on the interrelationships between the themes but focused more specifically on the role of the construction sector in relation to sustainability. In addition, the concept of the Journal Club was introduced to the students, by disseminating a peer-reviewed journal paper that reviewed definitions of sustainability¹⁰ with instructions on how to 'deconstruct' the paper into manageable sections i.e. abstract, conclusions, methodology, references etc. At the end of class, each student received the STEEP assignment brief¹¹, which required the selection of five peer-reviewed journal papers related to the five individual STEEP headings and the construction sector i.e. 'corporate social responsibility within the construction sector' would align with the Social heading, 'waste prevention on site' would align with the Environmental heading etc. Each student had to produce a short literature review summarising these papers and exploring the interrelationships between them. For week 3, each student had to select one peer-reviewed journal paper on any one of the five STEEP headings, summarise it and submit it to Moodle for feedback in class.

Week 3 – a random sample of students were asked to identify what journal paper they selected and why, which facilitated a discussion on the literature review process i.e. use of library databases versus other sources i.e. Google, Google Scholar, Research-Gate, Academic.edu etc. General feedback was provided on all submissions focusing on paper selection, structure and layout of the report, referencing, academic writing and plagiarism. For week 4, each student had to select two more journal papers and submit a summary within the report structure before next week's class.

Week 4 – general feedback was provided on all submissions with a specific focus on plagiarism¹², referencing and academic writing. In-class activities focusing on these aspects were also carried out to highlight their importance including a self

⁹ Elements of this survey will be completed by the students at the end of the year to determine any change in their attitudes and self-reported behaviours.

¹⁰ Glavic and Lukman (2007) Review of sustainability terms and their definitions, *Journal of Cleaner Production*, V15, 1875-1885.

¹¹ The assignment is usually worth 10%. The assignment involved producing a 1500 (min.) to 2000 (max.) word paper considering the STEEP implications on sustainability in the construction sector.

¹² All submissions are scanned using a plagiarism software embedded into Moodle.

review exercise where student ‘marked’ through own work using the assessment rubric¹³. For week 5, each student had to submit a full draft of the report covering five selected journal papers before next week’s class.

Week 5 – a peer review exercise was carried out where students ‘marked’ each other’s final draft using the assessment rubric. General feedback was also provided by the lecturer to all students. The final assignment was submitted in week 6.

Week 6 – submission of final assignment to Moodle.

Week 8 – as part of the feedback process, each student was asked to self-review their final assignment in-class using the assessment rubric. If the student’s mark came within 1% of the lecturer’s mark, the submission would receive the higher mark. After each student marked their own assignment, the lecturer’s individual feedback forms were disseminated so that they could compare both marks and feedback.

Week 9 – students were asked to provide some reflective comments anonymously on the STEEP assignment and use of the Journal Club.

Some example qualitative responses in relation to the STEEP assignment included:

‘I found the assignment difficult to comprehend at first as I have never heard of a STEEP analysis and found it hard to relate the analysis to the construction industry. When I was researching papers on STEEP, I found it hard to find any examples of where it was used in construction so I decided to break the search down into the different sections. In the end I learned how STEEP analysis can be used when determining if a project is viable.’

‘I thought it was very helpful for preparing for my dissertation because I had never done research with journal papers before.’

‘Good, challenging, educational, great use of research.’

‘I found the STEEP approach assignment good as we got used to using the library search engine, we also learned to use the Harvard referencing system, and also it prepared us for our literature review for our dissertation.’

‘Found it a more suitable way for learning about sustainability in the construction sector rather than looking at a PowerPoint presentation or lecture notes. Found the STEEP analysis a good model for researching the topic.’

The feedback seems to indicate a positive response to the exercises in that it challenged the student, who in turn had to engage in research-orientated activities i.e. use of appropriate search engines, referencing, literature review etc. It is noted however that the responses are more focused on research competences and skills than exploring sustainability-related insights, which highlights a limitation in reflection and feedback tool in that it is too general and would benefit from a more structured approach. This trend is continued in qualitative comments made in relation to the Journal Club:

‘The journal club paper module I found the most useful as it introduced us to the papers and online resources that are available. We also learned how to read the papers and analyse them.’

‘Most of the papers were long and difficult to read.’

‘Again a good way for practicing for dissertation work. I found some of the papers a bit hard to read.’

¹³ The rubric consisted of the following headings: cover and contents page; appropriate sections; clear and correct referencing; correct font and spacing; merging of referenced material throughout the text; correct spelling, use of paragraphs and grammar; appropriate summary pulling together all the elements of a STEEP analysis; references page with correct referencing.

'The journal club papers provided us with good techniques for reading a paper for our dissertation.'

'Good, as it was an introduction into reading journals and understanding the structure, which I found brilliant when it came to preparing to write the dissertation.'

'Good idea to become familiarised with the layout of a journal as it will help in future research for projects, and also the construction of reports. However, I found that printing out and reading a new journal every week was both time and money consuming as we were also trying to find and read journals to help us with getting started on our dissertations.'

Again, these activities proved challenging but provided a cross-module benefit as the work carried out did directly link to the activities they were engaged in the preparation of their dissertation as it encouraged students to engage in critical analysis to assess the validity, usefulness and applicability of previous research (Honey and Baker, 2011).

Towards the end of the module (in week 25), an in-class assignment using the STEEP methodology was applied to four scenarios (Resourceful Regions, Sunshine State, Carbon Creativity and Green Growth) taken from the *UK Powering Our Lives* project. By providing a future vision to the students, it introduced the concept of back-casting¹⁴. The exercise composed of three parts:

- The class was divided into four groups, who had to work back from the allocated future vision to carry out a STEEP analysis of the perceived influential factors. Each group had to mind-map the drivers highlighting any interrelationships while also identifying areas for further investigation. Each group posted their mind-map and future vision on the wall for comment by the other groups.
- All the comments and ideas proposed were used in the preparation of each group presentation, which detailed what was required to transition towards their allocated future vision using the STEEP framework as a guide. Each group critically evaluated each other's proposals to stimulate dialogue and debate.
- Each student had to prepare a short reflective essay (1500-2000 words) outlining the role of the construction sector in the transition towards any one of the future visions.

Some qualitative feedback on the use of back-casting included:

'This assignment I found useful as it put all the different areas we learned into a practical scenario from which we had to identify the contributing factor to the scenario.'

'The theoretical situation appeared very farfetched, but it did put some elements of the STEEP into practice.'

'Good exercise for working in teams. I found that last bit of the exercise difficult because we were finishing off our presentation so didn't get to listen to everyone else's and wasn't able to comment on what they had spoken about. I thought it was a good format as you knew exactly what you were supposed to be doing and how long you had.'

'Very challenging.'

'I found the STEEP back-casting exercise good as it was a practical exercise and one that we could be faced with in the workplace in years to come.'

¹⁴ It is recognised that a 'true' back-casting exercise would engage the students in the development of a future vision(s) but it was felt that by allocating an existing future vision developed by an extensive foresight study, it would provide a useful introduction to back-casting and enable the students to apply the STEEP methodology in a different context.

5. Discussion and Reflection on STEEP, Back-casting and Journal Club Exercises

The feedback comments reflect an overall positive attitude towards the use of STEEP, back-casting and Journal Clubs as part of the teaching and learning strategy. The exercises did provide space for more dynamic class interaction, where the lecturer acted primarily as a facilitator responding to queries as they arose. The students were proactive in attempting the exercises and assignments utilising the group environment but also leaving room for individual development. There was a limitation in the design of the student critical reflection element due to its unstructured and open format as students tended to focus on their research skills development rather than any related sustainability attitudes, behaviours, skills or competences. This, however, may be a finding in of itself as it did not 'direct' the responses in any way. Lambrechts and Van Petegem (2015) did find that research skills are often mentioned to contribute to the acquisition of competences for sustainable development, albeit usually from a more general perspective. These piloted learning interventions were situated within a more reformative approach i.e. learning FOR sustainability, as they employed a participatory methodology to encourage the active role of the learner in exploring different ways of knowing (Sterling, 2004). Extensive further work is needed to provide a more holistic approach to embedding sustainability across the built environment curriculum. From the initial findings, it is clear that the use of these activities can play a key role in engaging students and support the transition towards a more transformative (learning AS sustainability) learning experience.

References

- Barth, M., Godemann, J., Rieckmann, M. and Stoltenberg, U. (2007) Developing key competencies for sustainable development, *International Journal of Sustainability in Higher Education*, V8(4), 416-430.
- Barth, M. and Rieckmann, M. (2012) Academic staff development as a catalyst for curriculum change towards education for sustainable development: an output perspective, *Journal of Cleaner Production*, V26, 28-36.
- Bates and Kane (2009) *Building the Future: Four Vision of the New Zealand Built Environment in 2025*, BRANZ Summary report.
- Bielefeld, A.R. (2011) Incorporating a Sustainability Module into First-Year Courses for Civil and Environmental Engineering Students, *Journal of Professional Issues in Engineering Education and Practice*, V137(2).
- Blizzard, J., Klotz, L., Pradhan, A. and Dukes, M. (2011) Introducing whole-systems design to first-year engineering students with case studies, *International Journal of Sustainability in Higher Education*, V13(2), 177-196.
- Brundtland, G. (1987) *Our Common Future*, report of the World Commission on Environment and Development, United Nations General Assembly, New York.
- Buchan, G.D., Spellerberg, I.F. and Blum, W.E.H. (2007) Education for sustainability: Developing a postgraduate-level subject with an international perspective, *International Journal of Sustainability in Higher Education*, V8(1), 4-15.
- Burnstein, J.L., Hollander, J.E. and Barlas, D. (1996) Enhancing the value of journal club: use of a structured review instrument, *American Journal of Emergency Medicine*, V14(6), 561-563.
- Carlsson-Kanyama, A., Dreborg, K.H., Eenkhorn, B.R., Engstrom, R. and Falkena, B. (2003) *Image of everyday life in the future sustainable city: Experiences of back-casting with stakeholders in five European cities*, The Environmental Strategies Research Group report 183, The Royal Institute of Technology, Stockholm, Sweden, 2003.

- Clements, J.N. and Trompeter, J.M. (2011) An innovative format of journal club among pharmacy practice residents, *Currents in Pharmacy Teaching and Learning*, V3, 327-332.
- Cotgrave, A.J. and Kokkarinen, N. (2010) Developing a model promoting sustainability literacy through construction curriculum design, *Structural Survey*, V28(4), 266-280.
- Cotgrave, A.J. and Kokkarinen, N (2011) Promoting sustainability literacy in construction students, *Structural Survey*, V29(3), 197-212.
- Department of Communications, Climate Action and the Environment (DCCAE) (2018) *Sustainable Development Goals National Implementation Plan 2018-2020*.
- Department of Education and Skills (2014) *National Strategy on Education for Sustainable Development 2014-2020*.
- Dirsch, D.R., Tornetta, P.I. and Bhandari, M. (2003) Designing, conducting and evaluating journal clubs in orthopaedic surgery, *Clinical Orthopaedics and Related Research*, V413, 146-157.
- Dobson and Tomkinson (2012) Creating sustainable development change agents through problem-based learning, *International Journal of Sustainability in Higher Education*, V13(3), 263-278.
- DoECLG (Department of the Environment, Heritage and Local Government) (2012) *Our Sustainable Future*.
- Down, L. (2006) Addressing the challenges of mainstreaming education for sustainable development in higher education, *International Journal of Sustainability in Higher Education*, V7(4), 390-399.
- Dreborg, K.H. (1996) Essence of back-casting, *Futures*, V28, 813-828.
- Environmental Protection Agency (EPA) (2009) *National Waste Report 2008*.
- Ferrer-Balas, D., Adachi, J., Banas, S., Davidson, C.I., Hoshikoshi, A., Mishra, A., Motodoa, Y., Onga, M. and Ostwald, M. (2008) An international comparative analysis of sustainability transformation across seven universities, *International Journal of Sustainability in Higher Education*, V9(3), 295-316.
- Filho, L. (2009) Sustainability at Universities: opportunities, challenges and trends, in: W. Leal Filho (Ed.) *Sustainability at Universities: opportunities, challenges and trends*, Peter Lang, 313-319.
- Glavic, P. and Lukman, R.K. (2007) Review of sustainability terms and their definitions, *Journal of Cleaner Production*, V15(18), 1875-1885.
- Godet, M. (2000) The Art of Scenarios and Strategic Planning: Tools and Pitfalls, *Technological Forecasting and Social Change*, V65, 3-22.
- Golde, C.M. (2007) Signature pedagogies in doctoral education: are they adaptable for the preparation of education researchers? *Educational Researcher*, V36(6), 344-351.
- Government of Ireland (2019) *Climate Action Plan in 2019*.
- Graham, P. (2000) Building education for the next industrial revolution: Teaching and learning environmental literacy for the building professions, *Construction Management and Economics*, V18(8), 917-925.
- Hall, Z.W. (2006) Maintaining vitality through change: graduate education in neuroscience, In: C.M. Golde and G.E. Walker (Eds.) *Envisioning the future of doctoral education: preparing stewards of the discipline*, Carnegie essays on the doctorate, San Francisco: Jossey-Bass.

- Hammick, M. (1995) A research and journal club: a medium for teaching, professional development and networking, *European Journal of Cancer Care*, V4, 33-37.
- Hayles, C.S. and Holdsworth, S.E. (2008) Curriculum Change for Sustainability, *Journal for Education in the Built Environment*, V3(1), 25-48.
- Higher Education Authority (HEA) (2018) Higher Education System Performance Framework 2018-2020.
- Holt, D. (2003) The role and impact of the business school curriculum in shaping environmental education at Middlesex University, *International Journal of Sustainability in Higher Education*, V4, 324-343.
- Hopkinson, P. and James, P. (2010) Practical pedagogy for embedding ESD in science, technology, engineering and mathematics curricula, *International Journal of Sustainability in Higher Education*, V11(4), 365-379.
- Horneff, J.G., Baldwin, K. and Ahn, J. (2010) The Value of Journal Clubs in Orthopaedic Resident Education, *University of Pennsylvania Orthopaedic Journal*, V20, 154-159.
- Jantsch, E. (1967) *Technological forecasting in perspective*, OECD, Paris, France.
- Jung, Y.; Park, K. and Ahn, J. (2019) Sustainability in Higher Education: Perceptions of Social Responsibility among University Students, *Social Sciences*, V8 (90).
- Kibert, C.J. and Grosskopf, K. (2008) Radical sustainable construction: Envisioning next generation green buildings, *Rethinking Sustainable Construction 2006 (RSCO6)*, Sarasota, Florida, USA, 19-22 September 2006 [cited in Hayles and Holdsworth (2008)].
- Kokkarinen, N. and Cotgrave, A.J. (2013) Sustainability literacy in action: student experiences, *Structural Survey*, V31(1), 56-66.
- Klapper, S.J. (2001) A tool to educate, critique and improve practice, *Association of Operating Room Nurses Journal*, V74(5), 712-715.
- Lambrechts, W. and Van Petegem, P. (2015) The interrelations between competences for sustainable development and research competences, *International Journal of Sustainability in Higher Education*, V17(6), 776-795.
- Linzer, M. (1987) The journal club and medical education: over one hundred years of unrecorded history, *Postgraduate Medical Education*, V63, 475-478.
- Lovin, A. (1976) Energy strategy: the road not taken? *Foreign Affairs*, V55, 63-96.
- Lovin, A. (1977) *Soft Energy Paths: Toward a Durable Peace*, Friends of the Earth/Ballinger Publishing Company, Cambridge, MA, 1977.
- Lozano, F.J., Huisingh, D. and Delgado, M. (2006) An integrated, interconnected multidisciplinary approach for fostering SD at the Monterrey Institute of Technology, Monterey Campus, ESDA, Technical Paper No. 3 in Holmberg, J. and Samuelson, B.E. (Eds.) *Drivers and Barriers for Learning for Sustainable Development in Higher Education*, UNESCO, Paris, 37-47.
- Lozano-Garcia, F.J., Gandara, G., Perrni, O., Manzano, M., Hernadez, D.E. and Huisingh, D. (2008) Capacity building: a course on sustainable development to educate the educators, *International Journal of Sustainability in Higher Education*, V9(3), 257-281.

- Menoni, S. (2006) Introducing a transdisciplinary approach in studies regarding risk assessment and management in educational programs for environmental engineers and planners, *International Journal of Sustainability in Higher Education*, V7(3), 309-321.
- Metzger, N. and Zare, R.N. (1999) Science policy – interdisciplinary research: from belief to reality, *Science*, V283, No. 5402, 642-643
- Murray, P.E. and Cotgrave, A.J. (2007) Sustainability literacy: the future paradigm for construction education? *Structural Survey*, V25(1), 7-23.
- Mieg, H.A. (2006) System experts and decision making experts in transdisciplinary projects. *International Journal of Sustainability in Higher Education*, V7, 341-351.
- Muhar, A., Vilsmaier, U., Glanzer, M. and Freyer, B. (2006) Initiating transdisciplinarity in academic case study teaching: Experiences from a regional development project in Salzburg, Austria, *International Journal of Sustainability in Higher Education*, V7(3), 293-308.
- Newswander, L.K. and Borrego, M. (2009) Using journal clubs to cultivate a community of practice at the graduate level, *European Journal of Engineering Education*, V34(6), 561-571.
- Orr, D. (1992) *Ecological Literacy: Education and the Transition to a Postmodern World*, State University of New York Press, Albany, NY [cited in Hayles and Holdsworth (2008)]
- Phdungsilp, A. (2011) Future studies' back-casting method use for strategic sustainable city planning, *Futures*, V43, 707-714.
- Quist, J. (2007) *Back-casting for a sustainable future: the impact after 10 years*, PhD thesis, Faculty of Technology, Policy and Management, Delft University of Technology, The Netherlands, 2007.
- Rameriz, M. (2006) Sustainability in the education of industrial designers: the case for Australia, *International Journal of Sustainability in Higher Education*, V7(2), 189-202,
- Ratcliffe, J. (2000) *Scenario Building: A Suitable Method for Strategic Construction Industry Planning?* Futures Academy, Dublin Institute of Technology, 2000.
- Ratcliffe, J. and Sirr, L. (2003) *Futures Thinking for the Built and Human Environment*, Futures Academy, Dublin Institute of Technology, 2003.
- Ratcliffe, J. and Krawczyk, E. (2004) *Imagineering Cities: Creating Liveable Urban Futures in the 21st Century*, Futures Academy, Dublin Institute of Technology, 2004.
- Ratcliffe, J. and Krawczyk, E. (2011) Imagineering city futures: The use of prospective through scenarios in urban planning, *Futures*, V43, 642-653.
- Rich, K. (2006) The journal club: A means to promote nursing research, *Journal of Vascular Nursing*, V24(1), 27-28
- Robinson, J. (1982) Energy back-casting: a proposed method of policy analysis, *Energy Policy*, V10(4), 337-344.
- Robinson, J. (2003) Future subjunctive: back-casting as social learning, *Futures*, V35, 839-856.
- Rusinko, C. (2010) Integrating sustainability in higher education: a generic matrix, *International Journal of Sustainability in Higher Education*, V11(3), 250-259.

- Savelyeva, T. and McKenna, J.R. (2011) Campus sustainability: emerging curricula models in higher education, *International Journal of Sustainability in Higher Education*, V12(1), 55-66.
- Segalas, J., Mulder, K.F. and Ferrer-Balas, D. (2012) What do EESD 'experts' think sustainability is? Which pedagogy is suitable to learn it?: Results from interviews and maps analysis gathered at EESD 2008, *International Journal of Sustainability in Higher Education*, V13(3), 293-304.
- Shriberg, M. (2002) Institutional assessment tools for sustainability in higher education: Strengths, weaknesses, and implications for practice and theory, *Higher Education Policy*, V15(2), 97-98.
- Sipos, Y., Battisti, B. and Grimm, K. (2008) Achieving transformative sustainability learning: engaging head, hands and heart, *International Journal of Sustainability in Higher Education*, V9(1), 68-86.
- Stauffacher, M., Walter, A.I., Lang, D.J., Wiek, A. and Scholz, R.W. (2006) Learning to research environmental problems from a functional socio-cultural constructivism approach: The transdisciplinary case study approach, *International Journal of Sustainability in Higher Education*, V7(3), 252-275.
- St. Pierre, J. (2005) Changing Nursing Practice through a Nursing Journal Club, *MEDSURG Nursing*, V14(6), 390-392.
- Stubbs, W. and Cocklin, C. (2008) Teaching sustainability to business students: shifting mind-sets, *International Journal of Sustainability in Higher Education*, V9(3), 206-221.
- Stubbs, W. and Schapper, J. (2011) Two approaches to curriculum development for educating for sustainability and CSR, *International Journal of Sustainability in Higher Education*, v12(3), 259-268.
- Sterling, S. (2004) Higher education sustainability and the role of systematic learning, in Corcoran, B.P. and Wals, A.E.J. (Eds.) *Higher Education and the Challenge of Sustainability: Problems, Promise and Practice*, Kluwer Academic Publishers, Dordrecht, 49-70.
- Sterling, S. and Maxey, L. Introduction. In *The Sustainable University*; Sterling, S., Maxey, L., Luna, H., Eds.; Routledge: New York, NY, USA, 2013; pp. 1–14.
- Svanstrom, M., Palme, U., Wedel, M.K., Carlson, O., Nystrom, T. and Eden, M. (2012) Embedding ESD in engineering education – experiences from Chalmers University of Technology, *International Journal of Sustainability in Higher Education*, V13(3), 279-292.
- Swift, G. (2004) How to make journal clubs interesting, *Advances in Psychiatric Treatment*, V10, 67-72.
- Thompson, C.J. (2006) Fostering skills for evidence-based practice: The student journal club, *Nurse Education in Practice*, V6, 69-77.
- UN Environment (2017) Towards a zero-emission, efficient and resilient buildings and construction sector, Global Status Report 2017.
- UN Environment (2019) Global Resources Outlook 2019.
- UNESCO (2014) *Roadmap for Implementing the Global Action Programme on ESD*.
- UNESCO (2017) *Education for Sustainable Development Goals (SDGs) Strategy*.
- UK Department of Business, Innovation and Skills (2008) Powering our Lives: Sustainable Energy Management and the Built Environment Futures Report, UK Government Office for Science.

Wang, Y. (2009) Sustainability in Construction Education, *Journal of Professional Issues in Engineering Education and Practice*, V135(1).

Walker, G.W. et al. (2008) *The formation of scholars: rethinking doctoral education for the twenty-first century*, San Francisco: Jossey-Bass.

Warburton, K. (2003) Deep learning and education for sustainability, *International Journal of Sustainability in Higher Education*, V4(1), 44-56.

Wilmot, A. (2009) How to make your practicals more sustainable, available online: www.bioscience.heacademy.ac.uk/resources/ESD/howto.aspx

World Green Building Council (2019) *Bringing Embodied Carbon Upfront* report.

E-Mining@School; A Cross-Curricular Initiative To Embed Sustainability In The Junior Cycle Curriculum

Lisa Kiely¹, Jude Sherry² Colin Fitzpatrick²

¹Castletroy College, Newtown, Castletroy, Co. Limerick, Ireland

²Dept of Electronic & Computer Engineering, University of Limerick, Limerick, Ireland

lkiely@castletroycollege.ie

Abstract

Secondary level education in Ireland is going through a major transition with the introduction of the new Junior Cycle programme. For the first time sustainability is being embedded into every subject and teachers have been given the opportunity, and flexibility to create their own curriculum

Addressing this, 8 teachers at Castletroy College worked collaboratively on the “E-Mining@School” project to incorporate sustainability into their subjects’ curriculum using an ambitious multidisciplinary approach. This approach attempted to connect sustainability to the student’s everyday lives through the product that teenagers covet the most; their smartphones. The project developed a collaborative cross-curriculum pilot that explored the common theme of ‘urban mining of e-waste for Critical Raw Materials (CRMs)’ and the teachers integrated this common theme into the curriculum of 5 subjects that included Science, Geography, Business, Technology, and Civic, Social and Political Education (CSPE) that would be delivered concurrently.

The pilot ran for 4 weeks, beginning at the end of January 2019. A cohort of 220 2nd year students attended 60 lessons over all 5 subjects. 24 teachers delivered these lessons and each student received, on average, over 38 hours of lessons. The project culminated in a public WEEE collection event that recovered over 11 tonnes of WEEE that was sent for recycling. The second running took place in the Spring of 2020 and it is planned to continue it as an annual endeavour.

The pilot demonstrated to students the value of the resources used in their electronic products and the challenges of finite resource scarcity. It showed them not only where their stuff came from but also where it goes when they thought it thrown it away. Through the project students became familiar with and champions of the Circular Economy which was very evident in the WEEE collection event. The project was also the first occasion for the teachers to collaborate on a cross-curricular approach to secondary education and the paper includes findings on this topic.

1 Introduction to the Junior Cycle

The Framework for Junior Cycle (2015), outlines the key educational changes that the Department of Education and Skills (DES) Ireland is putting in place for young people in the first three years of their post-primary education. It outlines a vision of teaching, learning and assessment that supports inclusive, quality and relevant education for the young people of Ireland.

A major change for subject teachers as they moved from the Junior Certificate (1989) to the Junior Cycle (2015) was a move from a content driven syllabus to a learning outcomes-based specification. Each Junior Cycle subject specification consists of a series of learning outcomes. Subject teachers are encouraged to plan units of work to include a number of learning outcomes to give students a deeper understanding of the relationships and connections that exist between various elements of each subject specification. The development of 8 key skills are central to the learning that happens in Junior Cycle and beyond school. These key skills are embedded by a series of actions verbs in the learning outcomes of each subject specification.

The learning outcomes are broad and non-specific which gives teachers a degree of autonomy and flexibility to decide how best to ensure students achieve the intended learning. This autonomy has caused a degree of challenge to teachers across the country as they grappled with issues like depth of treatment and debated what should and should not be included as learning in each learning outcome.

2 EIT KIC Raw Materials Project

In March 2018, a team from the Dept of Electronic and Computer Engineering approached the school looking for a project partner to work on the design and delivery of an educational package aimed to raise awareness among students about critical raw materials in e-waste. This EIT Raw Materials funded project included partners from 5 European countries each aiming to work collaboratively with 2nd level educational institutions on this learning and education project. One aim of this project was to ‘teach the teacher’ so that 2nd level educators would be empowered to deliver aspects of this project moving forward without the continued support of the project partners.

The project aimed to teach students about raw materials and life cycle issues, e-waste management and recycling, raw materials business opportunities, entrepreneurship as well as a range of skills to include communication, working together and planning and organising a collection event.

This project coincided with unit planning in the area of sustainability within subject departments in school so it was an opportune time for teachers across a number of subject departments to come together and design a unit of work on the areas of sustainability but with the support of a research group or experts in the area from University of Limerick and on the common theme of critical raw materials. Students learning about sustainability in their use of mobile phone from the perspective of the different subject specifications would enable students to make meaningful and progressively more challenging connections between learning in different subjects.

A project coordinator was nominated, and a team of 7 interested teachers was put in place from five subject areas. The subject involved included science, business, geography, CSPE and metalwork.

3 Unit Planning Across Subjects

Unit planning commenced in September 2018 with members of the core design team meeting regularly in their free time, during lunch or during times allocated by school management. The process took a number of steps and will be outlined below.

1. Each subject area identified a number of learning outcomes that could be used to link around the topic of electronics and sustainability
2. Input was sought from UL on the area of critical raw materials. This subject matter was new to most members of the team and expertise was required to ensure common understanding of the topic as a whole.
3. Each subject department identified learning intentions related to the area of critical raw materials that would outline the intended learning in each of our learning outcomes.
4. Once the key learning was agreed in each of the subject areas, the team looked for common themes and arranged the learning on a weekly thematic basis.
5. Teachers then designed a range of student centred lessons which included learning activities that afforded students to take ownership and responsibility of their learning and that would develop a range of key skills as outlined by the Junior cycle framework.
6. Opportunities for students to reflect on their learning and in how they learn were deliberately embedded in the design of the module with the inclusion of a student learning log. Here students were able to identify the key learning in each of the subject per week as well as facilitated to make connections between the learning in each of the different subject areas.

4 Common Theme of Critical Raw Materials

The common theme of **Critical Raw Materials (CRM)** in smartphones was chosen for its relevance to students' everyday life given how dear phones are to teenagers.

The teachers defined their chosen theme as

Our stuff is made of stuff.

Our appetite to have new stuff appears to be unbounded. Billions of people around the world aspire to our standards of living and consumption. We never think about where the materials for our stuff come from and whether or not they will always be available to us in the future. Where do they come from? How are they mined/extracted? Why do we use the specific materials that we do? Where does our stuff end up?

The way we currently use materials is very wasteful and has complex environmental, social and economic consequence both now and for the future.

We need to move from this 'take-make-dispose' linear economy to a circular economy where materials are used multiple times. How do we do this? What is involved?

During this programme of study, students will study the origin, properties, uses of various metals, the environmental, social and economic consequences of our current practices in terms of origin and disposal of wastes and potentially develop newer and more sustainable business models

4.1 Critical Raw Materials

The European Union (EU) began identifying CRMs in 2010 after China set very tight export quotas for certain raw materials. This drove the EU to conduct a review of risks to the European economy in the event of a raw material shortage. This review resulted in the creation of a list of Critical Raw Materials (CRMs). CRMs are chemical elements identified by the EU based on three criteria that include:

1. being significantly economically important to key sectors in the European economy such as; medical; defence; low carbon technologies; consumer electronics and automotive.
2. having a highly risky supply from the likes of; trade wars; a lack of available mining reserves; rapid increase in demand for new technologies or wars in areas rich in ore deposits.
3. a lack of (viable) substitutes in their important applications.

Table 1 2017 List of Critical Raw Materials

EUs 2017 list of CRMs						
Antimony	Bismuth	Fluorspar	Helium	Magnesium	PGMs	Silicon metal
Baryte	Borate	Gallium	HREEs	Natural graphite	Phosphate rock	Tantalum
Beryllium	Cobalt	Germanium	Indium	Natural rubber	Phosphorus	Tungsten
	Coking coal	Hafnium	LREEs	Niobium	Scandium	Vanadium

The EU uses this list of CRMs to put policies and measures in place to alleviate the risk of material shortages or price increases. Measures they are looking at include new European mines, research into material substitutes and the creation of a Circular Economy in Europe.

The primary sources (virgin raw materials) of CRMs may be restricted due to

- geographical deposit, concentrated levels and diminishing reserves
- a lack of historical investment in material processing abilities
- only being extracted from the waste streams of mines that primarily mine other materials.

4.2 Circular Economy

Another potential source of CRMs is in existing products that are no longer used. The CRMs in existing products has already been mined, processed, produced into a product and even could have already been discarded. This is known as the Linear Economy of ‘Take - Make – Dispose’. A circular economy aims to recover CRMs in circulation (in existing products), so they can be recycled into new products. A Circular Economy aims to reduce the need virgin materials and new mines. Likewise, a Circular Economy could enable the EU to reduce dependence on the import of CRMs and thus reducing the risk to parts of its economy that rely on CRMs.

The availability of CRMs above ground will vary greatly depending on the material's application and history. Some materials will be locked up in long life products such as wind turbines. While others will be available in abundance in short life products like electronics. However, the biggest challenge is accessing these materials in an economically viable manner.

Once the topic of critical raw materials was understood by the teacher design team, it was then broken down as specific learning in each of the five subject areas that would achieve the learning outcomes in each of the subject specification.

This breakdown is outlined briefly in table 2.

Table 2 Overview of Learning Outcomes for Subjects Over the Course of the E-Mining@School Project

Subject	Week 1	Week 2	Week 3	Week 4
Science	<p>Define the term element, mixture and compounds, metals and non-metals and list their properties.</p> <p>Explain how the elements used in mobile phones have changed over the past decade.</p> <p>Work in groups to plan, design and carry out an investigation to determine if a material is an insulator or conductor of heat and electricity.</p>	<p>Introduce and discuss the concept of critical raw materials.</p> <p>Identify raw materials that are essential in manufacture of smart phones.</p> <p>Research and prepare a poster for presentation on one critical raw material.</p>	<p>Define energy and identify 5 different forms of energy</p> <p>Calculate the energy used while caring my mobile phone.</p> <p>Identify what my phone needs to interact with in order to function.</p> <p>Working in groups, analyse data from our student survey and identify patterns and trends in our phone use.</p>	<p>Appreciate the scale and impact of electronic waste and the dangers of human toxicity.</p> <p>Identify and list the advantages and disadvantages of our current systems for dealing with electronic waster.</p> <p>Discuss roles that can be taken to help organise a WEEE collection event.</p>
Geography		<p>Identify how natural resources can be extracted from the earth.</p> <p>Discover where resources can be found around the world.</p> <p>Describe the process of drilling, shaft mining and quarrying.</p> <p>Identify the advantages and disadvantages of quarrying.</p>	<p>Identify uses of cobalt.</p> <p>Compare how cobalt is extracted in the Democratic republic of Congo to how zinc is extracted in Navan, Co. Meath.</p> <p>Understand how natural gas is exploited in Ireland. Begin to understand how the exploitation of resources can become controversial over time.</p>	<p>Use the definition of sustainable development created in CSPE class and apply it to the exploitation of natural resources.</p> <p>Identify ways in which exploited mines can be used sustainably.</p>
CSPE	<p>Consider a variety of definitions of development and devise their own definition of sustainable development.</p> <p>Introduction to the UN Sustainable development goal 12: ensure sustainable consumption and production patterns.</p>	<p>Identify how UN SDG 12 can be linked to the issue of critical raw materials.</p> <p>Analyse a global issue-unsustainable consumption and production of critical raw materials.</p>	<p>Identify the impacts of electronic waste. Discover how electronic waste impacts on the lives of people in Ghana and China.</p> <p>Compare and analyse information.</p> <p>Identify possible solutions to the challenge of</p>	<p>Evaluate how I contribute to reduction the unsustainable consumption and production of critical raw materials.</p> <p>Identify waste materials in my environment that I can contribute to the waste recycling event.</p> <p>Work as part of a team to organise a waste collection event.</p>

	Understand the term ecological footprint.		unsustainable consumption of CRMs.	
Business	<p>Explain the term 'economic resources.</p> <p>Identify and explain each of the factors of production.</p> <p>Explain the term scarcity.</p> <p>Be able to distinguish between needs and wants.</p> <p>Explain how scarcity, choice and opportunity costs for individuals, companies and governments.</p>	<p>Discuss and compare economic systems.</p> <p>Centrally planned e.g. China, free market, USA and mixed economy, Ireland.</p> <p>Understand different sectors of the economy and identify the sectors that recycling companies work in.</p> <p>Explain how the different sectors interact.</p>	<p>Explain and distinguish between a closed economy and an open economy.</p> <p>Outline the importance of imports and exports for a country.</p> <p>Understand the factors of production. Begin to understand the importance of the government recognising the sustainability of resources.</p>	<p>Understand factors affecting demand and factors affecting supply.</p> <p>Understand a business plan and its importance to business.</p> <p>Understand the importance of sustainability.</p> <p>Discuss ethical business behaviours. Explain the term marketing. Explain the reasons for advertising. Plan for the marketing and advertising of the WEEE collection event.</p>
Engineering.		<p>Break is down</p> <p>Explain how design impacts on the function and quality of a product.</p> <p>Examine modern technologies, how they are designed and manufactured.</p> <p>Look at the role of CRMs in modern technologies.</p> <p>Students analyse the impact a disruption in supply of CRMs would have on the production of modern technologies.</p>	<p>Pick it apart</p> <p>Examine products design intent.</p> <p>Assess a product's intended life cycle.</p> <p>Evaluate the sustainability of a products design.</p> <p>Students will compare products with differing intended life cycles and discuss the sustainability of each.</p>	<p>Build it up.</p> <p>Design a new product concept with a more sustainable life cycle.</p>

5 Delivery – Moving to a Wider Team

Once the unit outline had been agreed and lesson plans and resources designed it was handed over to a wider team of delivery teachers. There are 7 base classes in each group so a team of over 20 teachers were required to deliver the unit to all 7 base classes in each of the five subject areas. 210+ second year students were taught this interdisciplinary unit over four weeks in January/February 2019 and again in January/February 2020.

Input and feedback had been sought from the wider delivery team numerous times during the design phase so that the rationale was clear and understood by all and all teacher felt a degree of ownership of the final product. The structure of the various partners is outlined in the diagram below.

Figure 1 Illustration of the Project Delivery

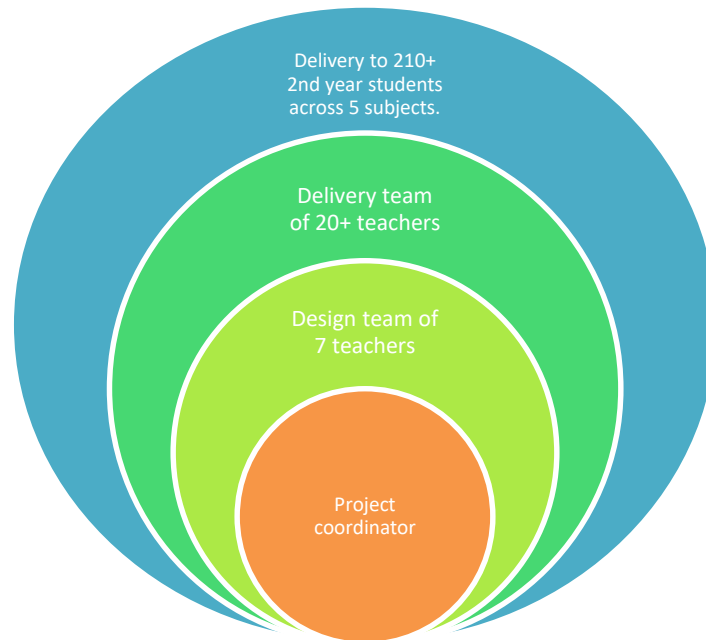

A google classroom for the teacher design and delivery teams was set up to share all resources and also to ensure good communication and sharing of ideas, progress and indeed challenges before, during and after delivery. The unit was delivered over a 4-week period and teachers were encouraged to complete a learning log at the end of each week. This ensured that classroom activities and strategies that worked well were logged and also connections that students made between learning each of the subject areas was identified. These reflections would form the basis of the evaluation of the unit at the end of delivery.

Figure 2 Sample of Photos from Project Activities



6 Impact Based on Evidence

Surveys were conducted before and after delivery with both with teachers and students. Feedback from these surveys was overwhelmingly positive. Students indicated that they felt that they got a rich and deep understanding of sustainability from all the pillars by learning about it concurrently in various subject areas. Students were interested in engaged in classes and the relevance of the topic to them and their lives helped in sustaining their interest and enthusiasm. Teachers reported that students were well able to take part in detailed discussions in classroom and connected and understood learning that happened on the topic in other subject areas. Teachers themselves felt that they learnt more about the subject areas through these detailed and informed discussion with students.

A group of students from the 2nd year cohort formed a core organising team and worked hard marketing and planning the WEEE collection event which was held in the school grounds a few weeks after delivery ended. The event was a huge success with 11tonnes of electronic waste dropped off for recycling on the day. Students turned up on the day and carried out a range of jobs such as logging number of cars as well as keeping an inventory from the various items that were being dropped for recycling. Students exhibited great interest and enthusiasm and were hugely proud of their efforts in collecting so much WEEE for recycling.

Figure 3 Selection of Photo's from WEEE Collection Event



7 Conclusion

Sustainability is a key element in a number of different subject specifications in the new Junior Cycle. Various aspects of sustainability are addressed in the different subject areas for example economic sustainability in Business and environmental sustainability in CSPE and Geography. Traditionally teachers would work with their subject departments and agree a scheme of work for the year, not knowing what was being taught in other subject areas or when.

In this project, teachers of five subject areas came together and planned a unit of work that would be delivered concurrently to provide students with an ability to make meaningful and progressively more challenging connections between learning in different subjects on the area of sustainability. The hope was the students would have a richer educational experience and a deeper understanding of the topic in questions.

Feedback from both students and teachers' surveys and focus groups would indicate that deeper learning and understanding happened and that students found the process engaging and interesting.

The process was challenging and time consuming and it was the first-time planning like this happened in our school or indeed in the majority of school around the country. There are huge benefits to students in this type of design and delivery and it will be an approach we will explore with other subject areas moving forward in our school. We are confident that our topic of sustainability is truly understood and embedded by our students and they have gained a deep understanding and can think critically about the complexity of all the pillars of the topic of sustainability.

8 Acknowledgements

This work has received funding from EIT Raw Materials Project E-Mining@School (Project number 17144)

The authors are grateful to the following people for their efforts in making the project a success

- Core Design Team for Castletroy College; Sharon Delaney, Kevin Grant, Linda Hannon, John Keehan, Ann-Marie McMahon & Marian Roche.
- European Recycling Platform; Charlotte Budd, Yvonne Holmes

References

Framework for Junior Cycle 2015 Department of Education and Skills p.13.
http://ec.europa.eu/growth/sectors/raw-materials/specific-interest/critical_en

Teaching circular economy: Discussing limitations and opportunities of teaching about sustainable production

Abstract: One of the essential drivers of sustainable change for the circular economy is natural resource scarcity. The key development in the area of sustainable production and consumption that seeks to limit or even, ideally, stop continuous extraction of natural resources, is the cradle-to-cradle (C2C) framework. The C2C framework is based on the book *Cradle to Cradle* by Michael Braungart and William McDonough first published in 2002. The circular economy also poses threats to conventional business and production as in its ideal form, circular production should not mean churning out even more supposedly ‘circular’, ‘sustainable’, or ‘green’ products but fully re-using materials. The products need to be made not only to last but to have, at least ideally, all reusable parts. This is no easy task. Overt optimism of some of the circular economy promoters, such as The Ellen MacArthur Foundation, needs to be tempered with realism and realization for the potential for greenwashing. Even more problematically, the concept of the circular economy is intended to align sustainability with economic growth – just as an equally problematic concept of sustainable development (and the associated education for sustainable development or ESD) does. While the European Union states that the circular economy will “foster sustainable economic growth”, critical scholars have noted that without radical degrowth in the economy (and population) circular economy is nothing but a new word for greenwashing. This paper will discuss how to teach students to think critically and pragmatically about the challenges and opportunities of the circular economy.

Keywords: circular economy; economic growth; education for sustainable development; environmental sustainability; greenwashing

Introduction: closed-loop production

Aside from the realization that environmental and social values are not found solely in economic terms one of the most essential drivers of change for the circular economy is natural resource scarcity. As the current system of ‘cradle to grave’ production, cheap consumer goods that are designed *not* to last – the concept known as ‘planned’ or ‘built-in’ obsolescence (Bulow 1986). Since producers are interested in consumers constantly buying their products, built-in obsolescence makes it economically unattractive to repair or reuse products. Simultaneously, many consumables are sold in potentially durable packages, while consumption item itself can be consumed in one gulp or bite. Many packaging materials could potentially last for hundreds of years and yet most of it is directly disposed of (Davis and Song 2006). The current industrial system erodes the biological and cultural diversity. Even eco-efficient industrial systems, while outwardly ‘green’, also lack in ambition as they typically signify a marginal reduction in the use of limited natural resources, rather than the complete

elimination of resource-depleting production (Washington 2015). Such systems may appear 'green' but they allow the industry to 'finish off everything, quietly, persistently, and completely' (Braungart and McDonough 2009: 62; 65). The electric cars might still consume electricity generated by using fossil fuels, which will stretch into the future without switching to true renewables such as sun and wind. 'Waste to energy' electricity, for example, which is touted as sustainable, destroys mixed materials (Braungart 2013).

The key development in the area of sustainable production and consumption that seeks to limit or even, ideally, stop extraction of natural resources, is the cradle-to-cradle (C2C) framework, based on the book *Cradle to Cradle: Remaking the Way We Make Things* (Braungart and McDonough 2002). C2C is based on the ideas of 'self-replenishing economy' (Stahel 1984), industrial ecology (Frosch and Gallopoulos 1989), ecological economics (Costanza 1992), regenerative economy (Geissdoerfer et al 2017), ecological management (Blomsma & Brennan 2017; Blok 2018).

Table 1 Overview of frameworks

Source: adapted from Tennant and Brennan (2015) and Kopnina and Blewitt (2018)

Thinkers	Concepts/Frameworks	Level of Application	Seminal Work by Year
Robert Ayres & Allen Kneese	Industrial Metabolism – understanding material and energy flows at the national level and within urban areas.	Industrial System	Ayres and Kneese (1969)
Barry Commoner	Ecological principles used to structure national economy	National	Commoner (1971)
Walter Stahel	Circular or loop economy through product life-extension.	Product Design	Stahel (1984)
Robert Frosch & Nicholas Gallopoulos	Industrial ecosystem	Industrial System	Frosch and Gallopoulos (1989)
Paul Hawken	Circular economy, restorative economy	Community	Hawken (1993)
John T. Lyle	Regenerative Design	National, industrial	Lyle (1996)
Thomas Graedel	Earth system ecology - biological systems and industrial systems influence each other.	Industrial System	Graedel (1996)
Janine Benyus	Biomimicry Design Framework based on looking at form, function, and processes in natural systems.	Product Design	Benyus (1997)
Gunter Pauli	Coined the term "upcycling". Developed the concept of the Blue Economy in a report for the Club of Rome.	Enterprise Development	Pauli (1998) Pauli (2010)

Michael Braungart & William McDonough	Cradle to Cradle (C2C) Design Framework.	Product Design	McDonough and Braungart (2002)
Critical approaches and revisions (greenwashing, business-as-usual)	Critical theory	General application	Rammelt and Crisp (2014) Haydn Washington (2015) Helen Kopnina (2017, 2018, 2019a and 2019b)

C2C seeks to create innovative production systems, rather than solely seeking profit by "digging up or cutting down natural resources and then burying or burning them" (Braungart and McDonough 2002:18). Critical scholarship in the fields of sustainable business and production is deeply skeptical of production that takes 'profit' as the only 'bottom line' (Kopnina and Blewitt 2018). Like C2C, circular economy (CE) aims to decouple economic growth from demand for natural resources. C2C is also closely related to biomimicry (Benyus 1997), and the blue economy (Pauli 2010).

There are several fundamental problems with the typical cradle-to-grave production system and associated management styles, as discussed by the authors of the C2C framework. Already in the nineteen sixties in the essay *The Economics of the Coming Spaceship Earth* (1966), Kenneth Boulding, a British economist, compares the 'cowboy' and the 'spaceman' economies. The first is characterized by the notion of limitless resources, with consumption and production seen as 'progress'. By contrast to this the cowboy economy, a 'spaceman economy' sees the Earth is a single spaceship, with limits for both what can be taken from it in terms of natural resources and what can be disposed of (pollution, garbage). In a more modern interpretation, this signifies the "economy of enough" (O'Neill 2012). As Boulding states, "man must find his place in a cyclical ecological system which is capable of continuous reproduction of material form even though it cannot escape having inputs of energy" (P. 4). In the spaceman economy throughput needs to be limited (Boulding 1966:5).

Instead of recreating these patterns of unsustainable production, the C2C system is intended to be beneficial to the environment. This ambition fits within the larger discussion of ethical issues associated with production processes that not only are profitable but also socially ethical and environmentally sustainable (Attfield 2015; Blok 2018). The application of this the deep ecology in business operations requires radical transformation and recognition of what is intrinsically valuable, including nonhuman nature – and not just the instrumental "natural resources" (Klikauer 2014; Attfield 2015). Practically, this implies the need to recognize that nonhuman species should be allowed to share space with human inhabitants in urban or rural environments, not just in 'nature'

where people can be seen as ‘guests’, but also recognizing that to be truly ‘part of nature’ humans need to adopt an ethics of conviviality (Van Dooren and Rose 2012). In green urban planning, buildings will contain plant and moss-covered roves and walls providing habitats or housing opportunities’ (such as nests) to other species as well (e.g. Oberndorfer et al 2007). Circular systems promise a radical departure from ‘less bad’ to ‘all good’ (Genovese et al 2015).

Circular economy challenges

Consider the priority table below:

Circular economy		Strategies	
 Increasing circularity	Smarter product use and manufacture	R0 Refuse	Make product redundant by abandoning its function or by offering the same function with a radically different product
		R1 Rethink	Make product use more intensive (e.g. by sharing product)
		R2 Reduce	Increase efficiency in product manufacture or use by consuming fewer natural resources and materials
	Extend lifespan of product and its parts	R3 Reuse	Reuse by another consumer of discarded product which is still in good condition and fulfils its original function
		R4 Repair	Repair and maintenance of defective product so it can be used with its original function
		R5 Refurbish	Restore an old product and bring it up to date
		R6 Remanufacture	Use parts of discarded product in a new product with the same function
	Useful application of materials	R7 Repurpose	Use discarded product or its parts in a new product with a different function
		R8 Recycle	Process materials to obtain the same (high grade) or lower (low grade) quality
R9 Recover		Incineration of material with energy recovery	
Linear economy			

We note here that a lot of practices that are currently branded as “circular” are in practice quite far from the ultimate goal, infinite reuse. One of the challenges of a circular economy is indeed what to do with most consumables, such as food and clothes. Can any food items, for example, really be "circular" once consumed – without addressing waste that ends up in the toilet? Simply, having eight billion omnivores on this earth can hardly be sustainable, as food or clothes are made of material elements, biomass, that once digested or worn for many years, degrade or become “downcycled”. The overt optimism of some of the circular economy promoters such as The Ellen MacArthur Foundation needs to be tempered with the realization of the potential for greenwashing. If strict assessment criteria are applied to some of the “best practice” examples, starting with Coca Cola, which reduces rather than eliminates a small proportion of its plastic packaging, it cannot be seen as “best practice” (Kopnina 2018; 2019a). The ‘hall of fame’ of supposedly “circular” companies often engage in eco-

efficiency and downcycling, using their stated intention to transit to the 'circular economy' as a way of justifying the retention of unsustainable patterns of production. The companies often focus on merely *minimizing* damage without the needed overhaul of the entire business model.

The circular promoters seem to overestimate the potential to close cycles of 'technical nutrients' given an expanding human population and the rise of high consumption is aspiring middle classes (Rammelt and Crisp 2004; Washington 2015; Kopnina 2019b). The shift to 'biological nutrients' to substitute for 'technological nutrients' may necessitate enormous monoculture plantations that will compete with crops and wilderness (Kopnina and Blewitt 2018).

While the circular economy or C2C may be most effective in the context of "degrowth" (O'Neill 2012) or radical limitations in the high level of consumption (Isenhour 2010; Rees 2010; Holt 2012), unfortunately, this goes against the grain of dominant economic thinking (Washington 2015). Without a strict certification system as with C2C, some companies that position themselves as "best practice" only grab the 'low hanging fruit'. While "buying less" is already challenging for most consumers, stopping shopping as a practice altogether is not what Western consumer culture encourages (Isenhour 2010: 460), and much of the subverted 'circular economy' may support the 'expansionist myth' (Rees 2010:5).

Optimistic and realistic scenarios

What is significant to remember about circular frameworks is that the critique of the current system of production, including the supposedly progressive sustainable efforts to promote recycling and eco-efficiency reaches far deeper than much of the conventional sustainability literature. The critique of recycling as actually downcycling, or eco-efficiency as an effort to make a bad system last longer are not easy to sell to mercantile-minded companies or the optimistic consumers. Yet, positive examples of simple C2C or circular products are not that hard to find in 'pre-industrial' designs, as demonstrated by the milkmen distributing refillable and washable milk bottles, or clay pots as containers. Instead of making new products, re-use can also offer a simple and cheap way of cycling resources. Some forms of innovative materials and production technologies, especially the ones supporting biomimicry (Benyus 1997), the blue economy (Pauli 2010) can certainly help as well. Still, the challenges of making some items such as food and clothing truly "circular" remain.

Reflection and conclusion: Teaching a circular economy

Considering the above, we can draw some conclusions as to how to teach students to think critically and pragmatically about the challenges and opportunities of the circular economy. First, the framework, with all its complexity and various definitions, needs to be discussed with students in such a way so that complexity is not lost while the core concepts (such as 9R hierarchy) and actions

(such as production methods that adhere to "closed-loop" principles) are made central. The students also need to be made aware of a larger social and political context that has a danger to subvert the practice of circular economy to business as usual scenarios. These scenarios emerge from the political and economic status quo that privileges economic growth and free markets that often resist government regulation of ecologically harmful or socially unjust processes and products.

Particularly fitting to this task is the employment of critical pedagogy and/or ecopedagogy. Originating in Marxist perspective, and based on the work of Paulo Freire (1972), critical pedagogy is a teaching approach inspired by critical theory, which attempts to help students question and challenge posited "domination" of capitalist, corporate, or political structures, and to challenge the broadly shared assumptions and practices that underline this domination (Kahn 2010). Having in part evolved from critical pedagogy, ecopedagogy is less ideologically leftist and more environment-centered (Nocella 2007). Remaining socially critical, ecopedagogy supports the position that learning about environmentalism prepares students to recognize the types of ethics that are seldom taught at school - deep ecology and ecocentrism (Sitka-Sage et al 2017), and inclusive multispecies pluralism (Kopnina & Cherniak 2016). Assuming that conventional environmental education and particularly education for sustainable development is still influenced by the anthropocentric economic thinking (Bonnett 2007; Kopnina, 2012, 2014; Sitka-Sage et al 2017), critical pedagogy scholars point out that "industries and the state have strong institutional and monetary biases" against justice for the environment (Nocella 2007: 3). In contrast to conventional education, critical pedagogy outlines an "approach to fight and unveil the complex and interwoven lies of the global capitalist machine" (Ibid). While it must be noted that critical pedagogy is informed by "green Marxism", its critical stance is not limited to socialist, communist or leftist politics. One can argue that the forceful removal of resources from the rich to redistribute to the poor – as in the noble aspirations of the Russian revolution – aside from bloody consequences, the total global economic pie stays the same, thus neo-Marxist slogan for 'equitable distribution' is not going to avoid adding billions to the class of global over-consumers. In education, this, therefore, does not imply that the students will be taught some "leftist ideology", as a neoliberal critique of progressive education sometimes states, but encourages critical thinking beyond the conventional greenwashing discourse of circular economy.

References

- Attfield, R. 2015. Sustainability and Management. *Philosophy of Management* 14: 85-93.
- Benyus, J.M. 1997. *Biomimicry: Innovation Inspired by Nature*. New York: Harper Collins Publishers.

- Blomsma, F. & Brennan, G. 2017. The emergence of circular economy: A new framing around prolonging resource productivity. *Journal of Industrial Ecology*, 21(3): 603-614.
- Blok, V. 2018. Philosophy of Innovation: A Research Agenda. *Philosophy of Management*, 17(1):1-5.
- Bonnett, M. 2007. Environmental education and the issue of nature. *Journal of Curriculum Studies*, 39(6): 707–721.
- Boulding, K. 1966. The Economics of the Coming Spaceship Earth. In *Environmental quality in a growing economy—Essays from the sixth RFF forum*, edited by H. Jarrett. Baltimore: The Johns Hopkins University Press. Pp. 3-15.
http://arachnid.biosci.utexas.edu/courses/thoc/readings/boulding_spaceshipearth.pdf
- Bulow, J. 1986. An economic theory of planned obsolescence. *The Quarterly Journal of Economics*, 101(4):729-749.
- Braungart, M. and W. McDonough. 2002. *Cradle to Cradle: Remaking the Way We Make Things*. London: Vintage.
- Braungart, M. 2013. *Waste to Energy*. <http://catalystreview.net/2010/02/cradle-to-cradle-transitioning-from-waste-incineration-to-beneficial-materials/>
- Costanza, R. 1992. *Ecological economics: the science and management of sustainability*. New York: Columbia University Press.
- Davis, G. and Song, J.H. 2006. Biodegradable packaging based on raw materials from crops and their impact on waste management. *Industrial crops and products*, 23(2):147-161.
- Frosch, R. A., and N. E. Gallopoulos. 1989. Strategies for manufacturing. *Scientific American* 261(3): 144–152.
- Geissdoerfer, M., Savaget, P., Bocken, N. M., & Hultink, E. J. 2017. The Circular Economy—A new sustainability paradigm?. *Journal of Cleaner Production*. 143: 757-768.
- Genovese, A., Acquaye, A., Figueroa, A. and Koh, S.C.L. 2015. Sustainable Supply Chain Management and the Transition Towards a Circular Economy: Evidence and Some Applications. *Omega* 66, 2017: 344–357.

Holt, D.B. 2012. Constructing sustainable consumption: From ethical values to the cultural transformation of unsustainable markets. *The ANNALS of the American Academy of Political and Social Science*, 644(1):236-255.

Isenhour, C. 2010. On conflicted Swedish consumers, the effort to stop shopping and neo-liberal environmental governance. *Journal of Consumer Behavior*, 9: 454-469.

Kahn, R. 2010. *Critical Pedagogy, Ecoliteracy, and Planetary Crisis: The Ecopedagogy Movement*. New York: Peter Lang.

Klikauer, T. 2014. Management Philosophy and Environmental Ethics—Critical Reviews. *Philosophy of Management*, 13(1):97-104.

Kopnina, H. 2016. Animal cards, supermarket stunts and World Wide Fund for Nature: Exploring the educational value of a business-ENGO partnership for sustainable consumption. *Journal of Consumer Culture*, 16(3): 926–94.

Kopnina, H. 2017. Teaching about sustainable production and consumption. *Sociocultural Perspectives on Youth Ethical Consumerism*. Ed. by G. Reis, M. P. Mueller, R. A. Gisewhite, L. Siveres and Brito, R. Dordrecht: Springer. Pp. 131-147.

Kopnina, H. 2018. Teaching circular economy: Overcoming the challenge of green-washing. *Handbook of Engaged Sustainability: Contemporary Trends and Future Prospects*. Ed. by S. K. Dhiman and Marques, J. Dordrecht: Springer.

Kopnina, H. 2019a. Towards ecological management: Identifying barriers and opportunities in transition from linear to circular economy. *Philosophy of Management*. In print.
<https://www.springerprofessional.de/en/towards-ecological-management-identifying-barriers-and-opportuni/16422786>

Kopnina, H. 2019b. Green-washing or best case practice? Using circular economy and Cradle to Cradle case studies in educational practice. *Journal of Cleaner Production*, 219:613-623.

Kopnina, H. and Blewitt, J. 2018. *Sustainable Business: Key issues*. Second Edition: Expanded and updated. Routledge, New York.

- Kopnina, H. & Cherniak, B. 2016. 'Neoliberalism and Justice in Education for Sustainable Development: A call for inclusive pluralism'. *Environmental Education Research*, 22(6):827–841.
- Kopnina, H. 2012. Education for Sustainable Development (ESD): The turn away from 'environment' in environmental education? *Environmental Education Research*, 18(5): 699–717.
- Kopnina, H. 2014. If a Tree Falls: Business students' reflections on environmentalism. *International Journal of Environment and Sustainable Development*, 8(3), 311–329.
- Nocella, A. 2007. Unmasking the animal liberation front using critical pedagogy: Seeing the ALF for who they are. *Journal for Critical Animal Studies*, 1, 1–10.
- Oberndorfer, E., Lundholm, J., Bass, B., Coffman, R.R., Doshi, H., Dunnett, N., Gaffin, S., Köhler, M., Liu, K.K. and Rowe, B., 2007. Green roofs as urban ecosystems: ecological structures, functions, and services. *BioScience*, 57(10):823-833.
- O'Neill, D.W. 2012. Measuring Progress In the Degrowth Transition to a Steady State Economy. *Ecological Economics*, 84: 221-231.
- Pauli, G.A. 2010. *The Blue Economy: 10 years, 100 innovations, 100 million jobs*. Paradigm publications.
- Rammelt, C., & Crisp, P. 2014. A systems and thermodynamics perspective on technology in the circular economy. *Real-world economics review*, 68: 25-40.
- Rees, W. 2010. What's blocking sustainability? Human nature, cognition, and denial. *Sustainability: Science, Practice, & Policy*, 6(2):13-25.
- Sitka-Sage, M. D., Kopnina, H., Blenkinsop, S., & Piersol, L. 2017. Rewilding Education in Troubling Times; or, Getting Back to the Wrong Post-Nature'. *Visions for Sustainability*. 8, 1–19.
- Stahel, W.R. 1984. The Product-Life Factor. In *an Inquiry into the Nature of Sustainable Societies, the Role of the Private Sector*. Susan Grinton Orr, ed. Houston, Texas: HARC.
- Van Dooren, T. and Rose, D.B. 2012. Storied-places in a multispecies city. *Humanimalia*, 3(2):1-27.
- Washington, H. 2015. *Demystifying Sustainability: Towards Real Solutions*, London, Routledge.

Using an Open Course Pack to Support Interdisciplinary Learning in Sustainable Energy Engineering

Kamaria Kuling¹, Taco Niet¹, and Sheena Miao Ying Tan²

¹School of Sustainable Energy Engineering, Simon Fraser University, Canada
kamaria_kuling@sfu.ca

²Faculty of Education, Simon Fraser University, Canada

Abstract

For interdisciplinary engineering programs, it can be difficult to find textbooks that meet the needs of the course – open educational resources (OER) are well suited to bridge this interdisciplinarity challenge. As there was no suitable textbook identified for the course SEE 310: Integrated Energy Solutions in the Sustainable Energy Engineering program at Simon Fraser University, we developed an OER course pack, entirely Creative Commons licensed, that introduces students to energy systems modelling techniques and different types of models. To gain feedback on the effectiveness of the course pack we surveyed the students in SEE 310 and invited them to participate in a focus group to discuss the course pack and how it could be improved. We received positive feedback including that, in almost all cases, they would prefer it over a traditional textbook. Through building the OER course pack, we discovered plenty of commitment to OER development and well-maintained OER repositories, but that material for higher level interdisciplinary undergraduate engineering courses is still difficult to find. Given the suitability and positive feedback from developing OER for SEE 310, we feel that OER are well suited to answer the complexity and interdisciplinarity of sustainable energy engineering.

1 Introduction

To meet the challenges of the climate crisis engineering students need increasingly integrated educational programs that will prepare them to face complex problems that transcend traditional disciplines (Lattuca et al. 2011). An issue arises when seeking textbooks to match such blended course material; often none exist. Open Educational Resources (OER) are well suited to bridge this complexity and interdisciplinarity challenge. OER often fit more varied learning styles as they don't have to be a consistent format and can incorporate videos, simple explanations, cutting edge research articles, and other elements to construct a versatile learning experience. OER are more accessible because, once they are created, they can be used for free. Depending on the licensing, they may also be remixed and reused for other courses. This accessibility makes them adaptable to the rapid technological changes and the growing complexity of sustainable engineering. As more resources are developed and shared, the accessibility of material, and the ease of adapting this material for new and different courses can accelerate.

One example of an interdisciplinary course where OER has been successfully deployed in Sustainable Energy Engineering is SEE 310: Integrated Energy Solutions at Simon Fraser University. SEE 310 introduces students to the modelling, simulation, and optimization of energy systems. As no suitable textbook was identified, we developed an open course pack to meet the needs of the course. The course pack is entirely under Creative Commons licenses and covers energy systems modelling techniques and model structures. We combined existing open-source resources into a course pack and, in the process, discovered that few resources existed for a course like SEE 310 and had to develop additional resources.

We have received positive feedback from both the SEE 310 students and an open energy modelling community on the course pack. Early in the process we put out a request for open learning materials to the online community OpenMod¹, energy modellers committed to open models, data, and resources. While some made suggestions and shared their own course materials, many more responded with excitement at eventually having access to the course pack. We found that others were seeking out similar resources, and since developing the open course pack a collection of open learning materials is being maintained on the OpenMod website², the core of which came from our request for information. In a survey and focus group we sought out student feedback on the course pack. Overwhelmingly, the students indicated they would prefer an OER to a traditional textbook due to the accessibility and format. There was also general agreement that it improved their understanding of the course concepts, and that the students would like to see it expanded to include more styles of learning material, such as reading quizzes. Given this positive feedback, we feel that OER are well suited to answer the complexity and interdisciplinarity of sustainable energy engineering.

2 Background

A report by the Canadian Digital Learning Research Association defines OER as “resources useful for teaching and learning (text, media, and other assets) that are freely accessible and openly-licensed (such as a Creative Commons license), where there is legal permission for creation, use, and reuse of educational content” (Johnson 2019). In this 2019 study, they also classify OER as being in an “exploratory and experimental stage.” This suggests that, while there is plenty of interest in OER, the development of these learning materials is still ramping up. Because they are free for students, OER have shown to reduce course withdrawal rates, and increase completion and enrollment rates for classes that adopt OER and can improve end-of-course grades (Hilton et al. 2016; Colvard, Watson, and Park 2018).

¹ <https://forum.openmod.org/>

² https://wiki.openmod-initiative.org/wiki/Learning_materials

Student performance in classes with OER are found to be the same or better than those with traditional for-cost textbooks (Hilton 2020; 2016; Delgado, Delgado, and Hilton 2019; Fialkowski et al. 2020). Additionally, both student and teacher perceptions of OER are found to be positive (Delimont et al. 2016; Jhangiani and Jhangiani 2017).

While the term ‘open’ generally means that something is available to use at no cost, there are different levels of openness as explained with the four ‘R’s of openness: Reuse, Redistribute, Revise, and Remix (Hilton et al. 2010). Reuse is considered the lowest level of openness, that others can freely use the material without modification. Redistribute is the next level, meaning that others can share the OER freely. The third level, revise, means that it can be modified and adapted from its original form. Finally, remix, the highest level of openness, requires that two or more OER can be mixed to create a new resource. Generally, once your resource is licensed for a higher level of openness the previous levels are also adopted. The Creative Commons³ provides options to openly license your work congruent with the four ‘R’s. All material newly developed for the course pack is under a CC BY-4.0 license, meaning that it can be freely shared and adapted as long as attribution is given.

Though in this case created for a specific course, the intention of any OER is that it can be shared and will be useful to other educators and self-learners. Understanding and following the Creative Commons licensing (or equivalent) is a vital step to developing OER, and when the OER is completed the licensing must be clear and obvious throughout. This ensures that others know how it can or cannot be used. With OER developed for specific courses, steps should be taken when sharing beyond the class to make sure it works in a broader context. Especially when the open resource is a full course, such as with MIT’s OpenCourseWare Initiative (MIT OpenCourseWare 2001), best practices include making the source files for material available in order to make them easily reusable. Steps must be taken to ensure that when converting to an open format the material from the course can stand on its own and doesn’t have key elements missing or broken links (DeVries 2013). To reduce barriers to the adoption and use of OER, ultimately there should be an institutional commitment to OER and a paradigm shift to openness (Peñaloza 2015; Jhangiani et al. 2016). This includes raising awareness, expertise and support from librarians, and sufficient time and funding to incorporate and create OER as well as research the impact of OER adoption.

3 Methods: Developing an OER for SEE 310

The purpose of developing the OER project was to support student learning in the Simon Fraser University course SEE 310: Integrated Energy Solutions. This course introduces students to modelling, simulation, and optimization of energy systems. The course pack contains an Introduction, Optimization Models, Building Energy Models, and Energy-Economy Models section. Each section is a combination of material written by the professor of the course, Dr. Taco Niet, and openly licensed educational material from various sources. The course pack compliments SEE 310 lectures to support student learning to comprehend fully the main features and strengths and weaknesses of each type of modelling. A focal point of the course, and course pack, is to be able to identify what model type would be most appropriate for a given situation. As SEE 310 covers a variety of energy systems modelling techniques and model structures, there were no existing OER or textbook identified that brought together all the course topics into a well-structured course pack. Although this project sought to combine existing open-source materials and resources into a course pack, a lack of existing OER required we develop a significant amount of the course pack from scratch.

³ <https://creativecommons.org/about/cclicenses/>

By exploring a number of different OER repositories and with assistance from librarians and researchers in the field we collected resources on energy modelling to combine into the course pack. A challenge and benefit to this process is that these resources are of many types and formats, such as research papers, practice questions, model documentation, and more, all openly licensed. The outcome is that the students have a variety of styles of educational resources to support their learning, providing a different experience from a traditional textbook. Most of the resources are not adapted into the course pack as they are useful as a stand-alone piece. In these cases, the course pack provides a link to the original webpage with an attribution included in the section. In the few cases where material is adapted into the course pack it is done with minimal changes and attributed immediately following the adapted material.

The course pack follows all topics covered in the course, namely explaining the different model types and their importance, structure, and appropriate uses. One expectation held at the beginning was that there would be more existing resources available to be compiled into the course pack. Finding resources that covered the material in a suitable way for SEE 310 proved to be challenging. Much of the existing resources, both open and not open licensed, is aimed at a graduate level course and was not targeted at undergraduate students. The resources that were at an undergraduate level and open licensed tended to focus on only a specific topic at a level more in depth than it is taught in SEE 310. The result of these challenges was that much of the course pack ended up being newly written for SEE 310 by the course instructor, Dr. Taco Niet. Given that the course pack incorporates longer and more technical readings in with those developed by Dr. Niet, these links can be considered supplementary readings that provide a broader context to the shorter readings available directly in the course pack. This ensures that the readings are an appropriate length for the students and avoids information overload, while still providing a well-rounded and comprehensive exploration of the course topics for a variety of learning styles.

The course pack is a combination of different OER and openly licenced journal articles, all entirely Creative Commons licensed or equivalent. Due to this, it made sense to individually license each section and provide attributions with licenses for all linked material. The alternative would be to choose the most restrictive license from the collected resources for the entire course pack. However, we wanted any material created by Dr. Niet for SEE 310 and the course pack to be as open as possible, in this case CC BY-4.0. For more details on the course pack, we have made it available through the OER to SFU's open resources repository, Summit⁴, and on the OpenMod website⁵.

4 Methods: Evaluating Effectiveness

To assess the student response to the OER, and get feedback on possible future improvements, we conducted a survey and a focus discussion group with the students in the class after the course was completed. This took place during summer in 2020 under COVID-19 regulations and therefore the class, focus group, and survey were all completed online. The ability to gain statistically significant findings from student evaluation of the OER course pack is limited due to only six students being in the class, with all six students participating in both the survey and focus group. The survey was anonymous, and a small stipend was given for its completion.

The purpose of this survey was to evaluate the effectiveness and student perception of the OER for SEE 310. It was sent to and completed by all six students in the first instance of SEE 310. It comprised of ten questions and was the second section of a survey that included other aspects of the course for a total of twenty-five questions. The questions consist of six Likert scale style questions, two multiple choice

⁴ <http://summit.sfu.ca/item/20738>

⁵ https://wiki.openmod-initiative.org/wiki/Learning_materials

questions, and two open ended questions. A complete summary of the survey results is available as a google doc⁶. The average time spent to complete the survey was seven minutes and thirty-nine seconds for the entire survey, of which approximately half concerned the course pack. None of the questions were skipped by the students.

The focus group was an opportunity to gain more context to the survey responses. It included discussions on other aspects of the course, with thirty minutes used to discuss the course pack. The questions asked in the focus group were:

1. Did the course pack help you gain understanding of the class concepts and material?
2. Did the course pack help prepare you for the lectures, labs, assignments, and your project? How?
3. Is each section of the course pack an appropriate length?
4. What did you like about the course pack?
5. Did you have any problems or difficulties with the course pack?
6. Do you have any suggestions on how to improve the course pack for future years?

5 Results, Feedback, and Discussion

In this section we discuss our findings from developing an OER course pack. With feedback collected through the survey and focus group, and by reflecting on the experience of developing and using the OER course pack for SEE 310, we consider the benefits, challenges, and suitability of using OER for this interdisciplinary undergraduate program.

5.1 Availability of Open Material

While many OER exist and there are well maintained OER repositories (“OER Commons” 2007; “BCcampus” 2013), it is more difficult to find material for higher level, interdisciplinary courses. Many of the resources identified while developing the OER for SEE 310 were either at a level too high for undergraduate students (such as the growing number of journal articles with a Creative Commons license that do not provide the foundational knowledge needed for a course) or aimed at core introductory university courses (such as first year math, physics, English, and so on). Educators appeared to be very willing to openly license their course materials, such as slides and videos. However, when using course material, it will often be specific to that course and not always easy to reuse.

While much of the course pack was newly created due to a lack of existing OER for this field of study, a number of journal articles and other resources were used. Journal articles can provide interesting insights into the course material, especially as applied examples, but are often too advanced for an undergraduate level. When asked if the course pack was difficult to understand, the results were mixed, with two students agreeing and three selecting ‘neither agree nor disagree.’ It was commented that some of the material was overly technical. A natural solution to a lack of OER for upper-level engineering classes is to develop more OER, and to continue to fund projects such as this one. As more OER exist, finding the right resources will become less difficult.

5.2 Support for a Variety of Learning Styles

Another result of there being less material aimed at higher level, interdisciplinary courses is the need to be more creative and utilize more varied resources. Many of those who develop learning materials are willing to share their course resources, such as slides, videos, and exercises, and many journal articles are openly

⁶ <https://docs.google.com/document/d/1fH8VfqF4g5AD2sQluyy-Xo4TBJnmnlI3ms2z673um84/edit?usp=sharing>

licensed. Using these varied and often multimedia styles of resources together to build a course pack can contribute to a learning experience that is different than traditional textbooks provide.

The students highlighted in both the survey and focus group that these differences were something they enjoyed about the course pack, and that they would like to see even more varied learning styles in future iterations. They provided feedback that the course pack could be expanded to include more information on each section and include more graphics and examples. In the focus group, the students suggested adding more reading questions or short quizzes into the readings to test their knowledge. One section of the course pack included an interactive tutorial of a model, with step-by-step instructions to complete. During the focus group, some of the students agreed this was a favourite part of the course pack because it was interactive. They encouraged more of this style of learning material to be added in future updates of the course pack.

An advantage of a traditional textbook style of learning material, whether it is openly licensed or not, is that the information is organized, detailed, and builds on itself throughout the chapters and sections. This can be more difficult to achieve when remixing existing OER and is a trade-off of having the variety of styles and sources of information. This could be another reason some students responded to the survey that the course pack was difficult to understand. While this can also be improved with increased availability of material, it also highlights the need of OER to be sufficiently and consistently funded so that enough material can be newly created for the course, as required.

5.3 Accessibility and Adaptability

In the survey, five students indicated they “would rather have the course pack than a traditional textbook,” commenting that they liked the zero cost, accessibility, and different format compared to a traditional textbook. The most obvious benefit of OER is that the students no longer need to purchase a textbook, reducing barriers based on cost to education. One student did report they would be willing to pay \$50 to replace the course pack with a traditional textbook, though practically a textbook for the course at this price is highly unlikely, and the average cost of the textbooks originally considered for the course (none of which sufficiently covered the course topics) was CAD\$129.10.

Textbooks are also regularly updated, adding to the cost as the newest edition needs to be purchased. Sustainable Energy Engineering and programs like it will need to adapt quickly to provide their students with the most up to date information for the changing field of sustainable energy. For this, OER have an advantage. As long as OER are being developed and shared, they can be remixed and adapted as needed.

OER are also more adaptable to feedback and students’ needs. Though there were two students that indicated the course pack did not compliment what they were learning, one reported that they never used the course pack and two used it only once a month. The results suggest that those who used the course pack regularly, at least once every two weeks, strongly agreed that it complimented the course. While some mixed reviews are always expected with course materials, an added benefit of the OER are their adaptability to the needs of students and learning styles. Having the opportunity to collect and incorporate feedback from the students can help to improve the course pack and course with relatively minimal effort compared to a traditional textbook.

As this was the first occurrence of SEE 310, it is expected that the course will evolve over time and with the experiences of the students and instructor. Depending on if future funding is available to continue the project, the course pack could be further developed and refined based on student feedback and changes to the course. To better support student learning based on feedback, a possible update would be to include more graphics and examples. Another helpful learning tool suggested in the focus group of students using

the course pack was to include reading questions to improve understanding and highlight the most important points. In addition to reducing the barrier of cost of education for students, using the format of OER rather than a traditional textbook is also more congruent to adapting to both evolving subject matter and students' needs.

5.4 *Online and Distance Learning*

Though also increasingly true of textbooks that are not openly licensed, OER in particular are generally accessed online. Especially given that this course took place during COVID-19 restrictions and was moved to be 100% remote at the last minute, there are unique opportunities to examine student learning in a remote environment. To support equitable online learning, OER are crucial, as we are seeing now more than ever. COVID-19 has had a profound impact on education and laid bare issues of inequality. As eLearning is embraced and becomes more necessary, utilizing OER can help educational institutions be resilient to these changes by fostering “connectivity, learning outcomes, and financial concerns” (Craig 2020). In SEE 310, the OER course pack helped to facilitate more interactive learning for students at home by using different styles of learning and types of resources, including activities.

6 Conclusion

SEE 310 provided one example where no traditional textbook was identified that fit the subject matter covered in the course and developing an OER was the most suitable option. It combined information from different sources such as journal articles, activities, and newly created material that can now be reused, redistributed, revised, and remixed under a CC BY license. In the future we plan to update the course pack as the course develops and by incorporating student feedback. As new relevant OER become available they can easily be used for the course or integrated into the course pack.

Given the growing evidence of the effectiveness of OER, the positive feedback from the students of SEE 310, and an ever-evolving understanding for the need for accessibility and openness in higher education, we feel that further OER development in higher education is needed. As more OER and material become available, it will be easier to find relevant resources that can be remixed into course packs that fit even the most interdisciplinary courses. Because of the inherent adaptability and resiliency to change, OER are more well-suited to courses that cover integrative subject matter.

References

“BCcampus.” 2013. BCcampus. <https://bccampus.ca/>.

Colvard, Nicholas B, C Edward Watson, and Hyojin Park. 2018. “The Impact of Open Educational Resources on Various Student Success Metrics.” *International Journal of Teaching and Learning in Higher Education* 30 (2): 15.

Craig, Chris. 2020. “2020 Pandemic: Resilient Canadian Higher Education Institutions Will Integrate OER.” In Proceedings of *The 14th International Multi-Conference on Society, Cybernetics and Informatics*, 10–21. <https://doi.org/10.34105/j.kmel.2016.08.002>.

Delgado, Huimei, Michael Delgado, and John Hilton. 2019. “On the Efficacy of Open Educational Resources.” *The International Review of Research in Open and Distributed Learning* 20 (1). <https://doi.org/10.19173/irrodl.v20i1.3892>.

Delimont, Nicole, Elizabeth C. Turtle, Andrew Bennett, Koushik Adhikari, and Brian L. Lindshield. 2016. "University Students and Faculty Have Positive Perceptions of Open/ Alternative Resources and Their Utilization in a Textbook Replacement Initiative." *Research in Learning Technology* 24. <http://dx.doi.org.proxy.lib.sfu.ca/10.3402/rlt.v24.29920>.

DeVries, Irwin. 2013. "Evaluating Open Educational Resources: Lessons Learned." *Procedia - Social and Behavioral Sciences* 83 (July): 56–60. <https://doi.org/10.1016/j.sbspro.2013.06.012>.

Fialkowski, Marie K., Allison Calabrese, Beth Tilinghast, C. Alan Titchenal, William Meinke, Jinan C. Banna, and Jennifer Draper. 2020. "Open Educational Resource Textbook Impact on Students in an Introductory Nutrition Course." *Journal of Nutrition Education and Behavior* 52 (4): 359–68. <https://doi.org/10.1016/j.jneb.2019.08.006>.

Hilton, John. 2016. "Open Educational Resources and College Textbook Choices: A Review of Research on Efficacy and Perceptions." *Educational Technology Research and Development* 64 (4): 573–90. <https://doi.org/10.1007/s11423-016-9434-9>.

Hilton, John. 2020. "Open Educational Resources, Student Efficacy, and User Perceptions: A Synthesis of Research Published between 2015 and 2018." *Educational Technology Research and Development* 68 (3): 853–76. <https://doi.org/10.1007/s11423-019-09700-4>.

Hilton, John, David Wiley, Jared Stein, and Aaron Johnson. 2010. "The Four 'R's of Openness and ALMS Analysis: Frameworks for Open Educational Resources." *Open Learning: The Journal of Open, Distance and e-Learning* 25 (1): 37–44. <https://doi.org/10.1080/02680510903482132>.

Jhangiani, Rajiv Sunil, and Surita Jhangiani. 2017. "Investigating the Perceptions, Use, and Impact of Open Textbooks: A Survey of Post-Secondary Students in British Columbia." *The International Review of Research in Open and Distributed Learning* 18 (4). <https://doi.org/10.19173/irrodl.v18i4.3012>.

Johnson, Nicole. 2019. "Tracking Online Education in Canadian Universities and Colleges: National Survey of Online and Digital Learning 2019 National Report." Canada: Canadian Digital Learning Research Association.

Lattuca, Lisa R., Lois Calian Trautvetter, David B. Knight, and Carla M. Cortes. 2011. "Promoting Interdisciplinary Competence in the Engineers of 2020." In *118th ASEE Annual Conference and Exposition*. ASEE Annual Conference and Exposition, Conference Proceedings. American Society for Engineering Education.

Massachusetts Institute of Technology. 2001. "MIT OpenCourseWare." Accessed February 13th, 2021. <https://ocw.mit.edu/index.htm>.

OER Commons. 2007. "OER Commons." Accessed January 8th, 2021. <https://www.oercommons.org/>.

Peñaloza, M. 2015. "OER strategies and best practices as success factors in Open Access initiatives in higher education." In *Proceedings of Open Education Global 2015: Innovation and Entrepreneurship*.

Engineering Accreditation Objectives and their Relationship to the Quality Assurance Standards for Engineering Education Programmes in Ireland

Kyne, Maria

Dean of the Faculty of Applied Science, Engineering and Technology, Limerick Institute of Technology, Republic of Ireland

Maria.Kyne@lit.ie

Key Words

Engineering Education Objectives, Accreditation Criteria, Award Standards, Professional Descriptors

Abstract

All programmes of study in Institutes of Technology in Ireland are subjected to internal programmatic review in five yearly cycles to ensure that the education programmes meet the quality assurance standards and are fit for purpose. In addition engineering and construction programmes undergo voluntary external accreditation by their respective professional bodies. Both processes differ in their focus and intent and the preparation required by the programme teams and managers. The two processes emphasise different aspects of engineering education. From the research literature, it has emerged that these assessment types are used worldwide, in varying ways and in regular cycles, for the quality assurance of engineering education programmes. Both the programmatic review and accreditation processes have evolved and diverged over time. Engineers Ireland has formally accredited all University and Institutes of Technology engineering programmes in Ireland since 1982. Engineering education programmes which satisfy the appropriate criteria laid down in the Engineers Ireland accreditation documents are deemed to meet the education standard required of individuals seeking one of the registered titles of Chartered Engineer, Associate Engineer and Engineering Technician. The Engineers Ireland accreditation process is consistent with international best practice and this is verified by their inclusion in international mutual recognition agreements. Significant consultation has taken place with the gatekeepers of these processes which includes the Registrars and Heads of Faculty in Higher Education Institutions, Quality and Qualifications Ireland (QQI) and the Registrar of Engineers Ireland. Incorporation of the programmatic review and accreditation processes into a single quality assurance process has long been an ambition of these gatekeepers. To achieve this ambition, it is imperative to determine whether it is possible to align the objectives of both processes. Twenty four triangulation documents were prepared comparing the QQI Engineering Award Standards, the QQI Professional Award Type Descriptors and the Engineers Ireland Accreditation Criteria. This allowed for comparison across the three engineering professional titles, their equivalent Irish National Framework of Qualifications levels for the three quality strands of knowledge, skill and competence and the five sub-strands of Mathematics and Sciences, Design and Development, Information Technology, Business Context and Engineering Practice. Even though there are differences in wording between the standards, there is over ninety percent alignment between all three sets of objectives in terms of their intent.

1 Introduction

The definition of the fundamental purpose of engineering education is given in the International Engineering Alliance *Graduate Attributes and Professional Competencies* document as

‘to build a knowledge base and attributes to enable the graduate to continue learning and to proceed to formative development that will develop the competencies required for independent practice’ (International Engineering Alliance (IEA), 2013).

Professional bodies measure the quality of engineering education in two ways. Outcomes evidence based criteria are used to evaluate engineering education programmes and competency based standards are used to assess if engineers can gain professional recognition. Two of the major quality assurance processes used to assess engineering education programmes involves internal higher education Institution programmatic review and external accreditation by the relevant professional body. Both processes have evolved and diverged over time with the programmatic review process emphasising a prospective view over the next five years and the Engineers Ireland accreditation process retrospectively assessing programmes.

These policy driven processes have many stakeholders and gatekeepers with different priorities and expectations but have considerable overlaps. Faculty staff view the programmatic review process as principally a review of the strategic focus and programme delivery statistics of the faculty/department and view the accreditation process as a more rigorous examination of the programme content.

Incorporation of the programmatic review and accreditation processes into a single quality assurance process has long been a desire of the faculty staff and management in Institutes of Technology in Ireland to minimise review fatigue and allow the processes to be completed within the same timeframe. This would strengthen engineering education provision and ensure the sustainability of both processes over time as well as allowing utilisation of a forward and backward lens when reviewing the engineering education programmes.

2 Context and Literature Review

Quality Assurance in Higher Education is the totality of systems, resources and information devoted to maintaining and improving the quality and standards of teaching, scholarship and research and of student’s learning experience (The Quality Assurance Agency in Higher Education, 1998).

Irish Institutes of Technology hold Delegated Authority to make their own awards and are obliged to have regard to quality assurance guidelines issued by Quality and Qualifications Ireland (QQI) (Quality and Qualifications Ireland, 2016). All registered education providers are required to conduct cyclical programmatic reviews of their programmes. In addition, *Standards and Guidelines for Quality Assurance in the European Higher Education Area (ESG)* requires that Higher Education Institutions should monitor and periodically review their programmes to ensure that they achieve the objectives set for them and respond to the needs of students and society (European Association for Quality Assurance in Higher Education (ENQA), 2015).

All programmes of study in Institutes of Technology in Ireland are subjected to internal programmatic review which is normally conducted on a faculty or department wide basis and involves a root and branch examination of programmes of study and how they have been delivered in the previous five years and how they plan to be delivered in the subsequent five years (Quality and Qualifications Ireland, 2016). Programmes are changed to include new technologies and new delivery methods whilst ensuring that graduates have the requisite skills and competencies to prepare them for the world of work which is based on Industry and stakeholder consultation.

Accreditation of engineering programmes by professional bodies such as Engineers Ireland (EI), The Society of Chartered Surveyors Ireland (SCSI) and others, are a vital part of ensuring that programmes are fit for purpose and that graduates have the requisite skills to be able to participate fully in their chosen profession (The Royal Institution of Chartered Surveyors (RICS), 2019) (Quality and Qualifications Ireland, 2019) (Quality and Qualifications Ireland, 2017).

Engineering education programmes which satisfy the appropriate criteria laid down in the Engineers Ireland *Accreditation Criteria for Professional Titles* document are deemed to meet the education standard required of individuals seeking one of the Registered titles of Chartered Engineer, Associate Engineer and Engineering Technician (Engineers Ireland, 2014). The accreditation process, as laid down in the document is consistent with international best practice and this is verified by their inclusion in international mutual recognition agreements, such as the Washington accord.

The accreditation process is voluntary and usually embraces a combination of self-evaluation, external peer review based on a site visit, recommendation by the visiting panel and the final decision is made by the responsible Accreditation/Education Board (Engineers Ireland, 2015). The focus of the accreditation process has changed significantly in the last ten years towards the measurement of student achievement of learning outcomes. According to the research literature, this new accreditation process focus has gained worldwide acceptance and is a driving force for ensuring the quality of engineering education programmes.

In 2015, the United Nations General Assembly formally adopted the universal, integrated and transformative 2030 Agenda for Sustainable Development along with a set of seventeen Sustainable Development Goals (The United Nations, 2015). The European Union has committed to implement these goals in their policies. Goal four specifically relates to ensuring inclusive and equitable quality education and the promotion of life-long learning opportunities for all. The EU prioritises the strengthening of education systems as the way to improve educational goals over time including strengthening young people's skills and employability (The European Union, 2020).

In engineering education quality assurance there are two main powerbrokers, the state and the professional bodies, acting as gatekeepers and controllers for the roll out of policy admission to the engineering profession. The processes have a gatekeeper function where admission to a professional elite is controlled by adherence to the relevant policies and procedures. It has emerged from consultation with the relevant gatekeepers and stakeholders to the processes that it is imperative to determine whether it is possible to align the objectives of these processes so that they have the same requirements which would make the possibility of combining them realistic and sustainable over time.

This paper sets out the procedure I created to examine whether the objectives could be aligned and lists the assumptions I made together with the outputs and conclusions from this review.

3 Gatekeeper and Stakeholder Engagement

Significant consultation has taken place with the gatekeepers of these processes. The Technological Higher Education Association (THEA) was established in the early 2000's to represent the Institute of Technology sector. Under THEA, the Council of Heads of School of Engineering (COHSE) was established. Incorporation of the programmatic review process and accreditation process into a single quality assurance process has long been an ambition of the COHSE.

The author prepared a discussion document and comparison analysis of the two processes in consultation with COHSE. The position paper concluded that there is considerable overlap between the programmatic review and accreditation processes and some realignment/amalgamation of the processes would achieve the same outcomes. Three COHSE representatives met with the THEA Council of Registrars and with the Registrar of Engineers Ireland who agreed in principle with the approach and recommended further consultation with QQI.

The author met with the relevant QQI staff and the Registrar of Engineers Ireland in June 2018 to consider if it is possible/practical to align or combine the programmatic review and Engineers Ireland accreditation processes. A comparison between processes has been completed and areas of similarity and difference highlighted. A small sample of this process comparison is illustrated in Table 1.

Table 1: Comparative Analysis Sample

<i>Process Stage</i>	<i>Process Activity</i>	<i>Programmatic Review</i>	<i>Accreditation</i>
Overview	Cyclic review period	5-7 years	5 years
Responsibility	Overall for the process	Institute Registrar for Academic Council	Engineers Ireland Registrar for the Accreditation Board
Objectives	Objectives set by	QQI and Institute's Academic Council	Engineers Ireland's Accreditation Board
Visit to HEI	Duration (Approx.)	1.5 days	2 days

Discussion took place on the use and roles of QQI Engineering Standards, the potential use of the Professional Award Type Descriptors (PATD's) and EI accreditation processes, similarity of language and purpose of processes. It was agreed in principle that the alignment process should be looked at further. A starting point would be the triangulation of the QQI Engineering Award Standards and QQI Professional Award Type Descriptors with the Engineers Ireland Accreditation Criteria. Consideration was also given to the QQI's policies and criteria for the validation and criteria of higher education programmes.

4 Triangulation of QQI Engineering Standards, QQI PATD's and Engineers Ireland Accreditation Criteria

4.1 Assumptions

The QQI Engineering Award Standards are set out in terms of the knowledge, skills and competence learning outcomes to be acquired by learners before a higher education and training award can be made (QQI, 2014). The standards are based on the level indicators and award type descriptors of the National Framework of Qualifications (NQF) (QQI, 2010). The standards are a reference point for the design of a programme in a specific field of engineering and are further divided into six sub-strands of Mathematics, Science, Information Technology, Design and Development, Business Context and Engineering Practice for each of the NFQ levels 6, 7, 8 and 9.

QQI has also published Professional Award Type Descriptors for the alignment of professional awards at NFQ levels 5, 6, 7, 8 and 9 which outline the typical uses to which the knowledge, skills and competence will be put (QQI, 2014).

Engineers Ireland's *Accreditation Criteria and Professional Titles* document sets out separately the accreditation criteria which apply to engineering education programmes for the three professional titles. The Accreditation Criteria are specified in terms of programme outcomes and programme area descriptors. There are six or seven programme outcomes and six programme area descriptors for each professional title.

The author, based on her knowledge and experience, made various assumptions regarding the triangulation process and the degree of similarity between these documents. In comparing across the three documents, the author made the following assumptions:

- (a) NFQ level 6 equates to the level of the Engineering Technician professional title
- (b) NFQ level 7 equates to the level of the Associate Engineer professional title
- (c) NFQ level 8 and 9 (combined) equates to the level of the Chartered Engineer professional title
- (d) The Engineering Award strands of knowledge, skill and competence, the professional award type descriptors and the Engineers Ireland programme outcomes were of a similar nature and could be directly compared
- (e) The Engineering Award sub-strands and the Engineers Ireland programme area descriptors are of a similar nature and could be directly compared
- (f) The Engineers Ireland discipline-specific technology programme area descriptor was incorporated into comparison tables where relevant and appropriate
- (g) The mathematics and science sub-strand was combined to provide a direct comparison with the sciences and mathematics programme area descriptor
- (h) The summarised tables 2 and 3 (shown in section 5) have been created by the author to allow for illustration of the comparison tables in this paper and are a close match to the actual comparison documents.

4.2 Methodological Approach

The author prepared Twenty four triangulation documents comparing the QQI Engineering Award Standards, the QQI Professional Award Type Descriptors and the Engineers Ireland Accreditation Criteria. This allowed for comparison across the three engineering Professional Titles, their equivalent National Framework of Qualifications levels for the three strands of knowledge, skill and competence and the five sub-strands of Mathematics and Sciences, Design and Development, Information Technology, Business Context and Engineering Practice.

The comparison documents are two-dimensional tables where the engineering award standards are split into three columns showing strand, strand descriptor and standard expected. The professional award type descriptors are separated into two columns with the descriptor and the standard expected. The comparable accreditation programme outcomes are given in one column showing the standard expected and the reference back to the exact subsection in the accreditation criteria.

5 Key Findings

There are a total of 24 *comparison documents* created in the triangulation process as follows:

- (a) 3 documents for the level 6/Eng. Tech. award – knowledge, skills, competencies
- (b) 3 documents for the level 7/Associate Eng. award – knowledge, skills, competencies
- (c) 3 documents for the levels 8 and 9/Chartered Eng. Award – knowledge, skills, competencies
- (d) 5 documents for the level 6/Eng. Tech. award for the programme area descriptors – Mathematics and Science, Information Technology, Design and Development, Business Context and Engineering practice

- (e) 5 documents for the level 7/Associate Eng. award for the programme area descriptors
- (f) 5 documents for the levels 8 and 9/Chartered Eng. award for the programme area descriptors.

Summarised samples of two comparison documents are given on tables 2 and 3, one strand and one sub-strand. The author summarised the tables as they would be too large to present in this paper.

Table 2: Competence Strand – NFQ Level 7/Professional Title Associate Engineer

<i>Engineering Award Standards</i>	<i>Professional Award Type Descriptors</i>	<i>Accreditation Criteria Programme Outcomes</i>
Context	Exercising autonomy and judgement	b, c(ii), c(iii), d, d(i), d (ii), d(iii), d(iv), e, f, f(i), f(ii), f(iii), f(iv) g, g(i), g(ii), g(iii) (Engineers Ireland, 2014)
Role	Exercising responsibility	
Learning to learn	Working with others	
Insight	Learning and Teaching Attitudes	

Table 3: Engineering Practice Sub Strand – NFQ Levels 8-9/Professional Title Chartered Engineer

<i>Engineering Award Standard</i>	<i>Engineering Award Sub Strand</i>	<i>Accreditation Programme Area Descriptor</i>
Knowledge breadth	Knowledge of current engineering practice	Familiar with engineering operational practice
Knowledge kind	Engineer's role in society and ethical standards	Awareness of codes of practice and ethics
Skill know how and skill range	Perform a management role in an engineering context	Day to day management of complex engineering projects
Skill know how and skill Selectivity	Apply principles to real engineering problems	Control engineering products or processes

Even though there are differences in wording between the standards and based on the assumptions made, it has emerged that there is a level of agreement between all the documentation of over 90%.

6 Discussion

The benefits of successful achievement of programmatic review and accreditation for the educational provider and graduates include public accountability, guarantee of quality, academic reputation, global professional recognition and registration, international mobility, academic improvement and educational competitiveness. Significant benefits also accrue to the professional bodies who remain the gatekeepers to the engineering profession.

Professional body accreditation policies cannot be enabled without engagement with engineering education programmes and they in turn need the seal of accreditation so that their graduates can be elected into a professional engineering association. The pursuit of accreditation has become mandatory for Higher Education Institutes as the consequences of not being accredited are dire for graduates who would not be able to practice as professional engineers (Said, et al., 2013).

Both quality assurance processes have evolved from humbler beginnings into substantial events and at the same time the importance of engineering education programme review and accreditation has also increased. The length of preparation and implementation of the processes has also increased with time. Many faculty staff have expressed the view that they are constantly reviewing engineering education programmes and are suffering from review fatigue (Kyne, 2019). As the processes have become more complicated, the desire to merge them has become more urgent. To ensure sustainable processes in the long term, some coming together of their objectives and implementation methodology is desirable.

The two processes have objectives that are expressed in a different manner, have different motivations and drivers and have been created by different entities. When comparing across similar levels, the differences are reduced to the point where the intention is the same but the language varies. As has been demonstrated in the comparison tables, these differences are small and could be adjusted to create a single set of objectives for both processes.

The single set of objectives will allow for an enhanced sustainable development focus in engineering education by ensuring the engineers role in society, the code of ethics, the complexity of real engineering projects, etc., are central in the quality assurance processes by ensuring their inclusion in engineering education curricula and improvements in teaching and learning practices. Engineering graduates will have the knowledge, skills and competence to actively support sustainable development in their engineering careers.

7 Conclusion

In Institutes of Technology there are many methods used to measure the quality assurance of engineering education programmes but the two major cumbersome processes are programmatic review and accreditation. Both processes differ in focus and intent but have considerable overlaps.

This paper explores the possibility of the alignment or combination of the programmatic review and accreditation objectives for engineering education programmes in Ireland. Comparisons across the three engineering professional titles and their equivalent National Framework of Qualifications levels has demonstrated that creating the same objectives across the two quality assurance processes is achievable.

The benefit to the engineering community of bringing the programmatic review and accreditation processes into a single process would be a reduction of process overlaps, significant saving in time and effort while ensuring both processes occur in the same time period. The single set of objectives could facilitate the alignment or combination of the processes to maintain the quality assurance of engineering education programmes as highlighted in the United Nations fourth sustainable development goal.

Acknowledgement

I would like to acknowledge the contribution of the members of the Council of Heads of School of Engineering, Council of Registrars, Registrar of Engineers Ireland and Quality and Qualifications Ireland to the content of this paper.

Bibliography

- Engineers Ireland, 2014. *Accreditation Criteria for Professional Titles*. [Online] Available at: <http://www.engineersireland.ie>
- Engineers Ireland, 2015. *Procedure for the Accreditation of Engineering Education Programmes*. [Online] Available at: <http://www.engineersireland.ie>
- European Association for Quality Assurance in Higher Education (ENQA), 2015. *Standards and Guidelines for Quality Assurance in the European Higher Education Area (ESG)*, Brussels, Belgium: European Association of Institutes in Higher Education (EURASHE).
- International Engineering Alliance (IEA), 2013. *Graduate Attributes and Professional Competencies*. [Online] Available at: <http://www.ieagrements.org>
- Kyne, M., 2019. *Professional Body Accreditation and the Quality Assurance of Engineering Education Programmes*. [Online] Available at: <https://warwick.ac.uk/fac/sci/wmg/mediacentre/wmgevents/eern>
- QQI, 2010. *Irish National Framework of Qualifications (NFQ)*. [Online] Available at: <https://nfq.qqi.ie>
- QQI, 2014. *Award Standards-Engineering*. [Online] Available at: <http://www.qqi.ie>
- QQI, 2014. *Professional Award Type Descriptors (Award Class: Professional) for the alignment of professional awards at NFQ levels 5,6,7,8,and 9*. [Online] Available at: <http://www.qqi.ie>
- Quality and Qualifications Ireland, 2016. *Core Statutory Quality Assurance Guidelines*. [Online] Available at: <http://www.qqi.ie>
- Quality and Qualifications Ireland, 2016. *Sector Specific - Insitute of Technology QA Guidelines*. [Online] Available at: <http://www.qqi.ie>
- Quality and Qualifications Ireland, 2017. *Professional Body Accreditation in Higher Education Institutions in Ireland*. [Online] Available at: <http://www.qqi.ie>
- Quality and Qualifications Ireland, 2019. *Accreditation Approval of Higher Education Programmes by Professional Bodies: QQI Insights*. [Online] Available at: <http://www.qqi.ie>
- Said, S. M. et al., 2013. Accreditation of Engineering Programmes: an evaluation of current practices in Malaysia. *International Journal of Technology and Design Education*, Volume 23, pp. 313-328.
- The European Union, 2020. *The Sustainable Development Goals, international co0operation and development*. [Online] Available at: https://ec.europa.eu/europeaid/policies/sustainable-development-goals_en
- The Quality Assurance Agency in Higher Education, 1998. *Quality Assurnace : a new approach*, London: Higher Quality, the bulletin of the QAA No.4.
- The Royal Institution of Chartered Surveyors (RICS), 2019. *RICS Global Accreditation - Policy and Process*. [Online] Available at: <http://www.rics.org>
- The United Nations, 2015. *Sustainable Development Goals*. [Online] Available at: <http://www.un.org/sustainabledevelopment/sustainable-development.goals>

What works? Sustainability Grand Challenges in Engineering Curricula via Experiential Learning

Amy E. Landis¹, Claire L. A. Dancz², Kristen Parrish³, Melissa M. Bilec⁴

¹Colorado School of Mines, USA

²Clemson University, USA

³Arizona State University, USA

⁴University of Pittsburg, USA

Abstract

Today's complex global problems necessitate engineering solutions that not only consider sustainability, but include elements of design and creativity. Unfortunately, many engineering programs do not train students to think in terms of multiple contexts and at various scales. We often constrain students' creativity to think within the narrow parameters of their specialization. Engineering educators face a difficult task of training students with both technical competencies and sustainability consciousness to tackle 21st century challenges. If we are to positively contribute to society, then we need to fundamentally change the way scientists, social scientists, and engineers are educated (Bielefeldt 2013).

Two successful models for implementing sustainability grand challenges into engineering curricula have emerged in practice and in literature: stand-alone courses versus modules that are integrated into many courses. Engineering programs implement the stand-alone course-based model by establishing one to two distinct courses designed to address sustainability grand challenges and design in depth. One example of this is senior design. Conversely, engineering programs implement the modular-based model by integrating sustainability grand challenges and design throughout a host of existing courses and weave student exposure throughout the curriculum. These modules can be via ready-made modules, but more often than not faculty develop their own modules. The goal of this research was to evaluate the two models for implementing sustainability and to provide succinct recommendations and lessons learned for engineering programs tasked with integrating sustainability into their curricula.

We review the implementation results of three sustainability courses, fourteen sustainability-themed modules, and senior design. We track progress towards responding to ABET Program Criterion related to sustainability and Civil Engineering Body of Knowledge 2nd edition (BOK2) Outcome 10: Sustainability. Results compare outcomes of students' senior design project from universities implementing the two different approaches. And finally, we present the results of a formative and summative surveys of hundreds of students who participated in classes implemented throughout the project as well as faculty perceptions and barriers to implementation.

Introduction:

The proposed activities incorporate recommendations from the National Research Council (NRC) for enhancing education in science, technology, engineering, and mathematics (STEM) disciplines by developing new experiences that facilitate diverse pedagogical approaches,

including project-based and active learning. The NRC recommendations include providing engaging laboratory, classroom and field experiences; teaching large numbers of students from diverse backgrounds; improving assessment of learning outcomes; and informing science faculty about research on effective teaching (Fox et al. 2003, Donovan et al. 2005, Bransford et al. 2006). Research suggests that team based projects can also enhance student learning in STEM fields since it promotes active and collaborative learning while simultaneously promotes individual accountability, personal responsibility, and communication skills (Allen et al. 2006).

The over-arching goal of this project was to train students to think outside the box, connect their learning to the real world, and prepare these students to tackle the engineering challenges of a global economy. Through this National Science Foundation funded project, we developed 14 modules and 3 courses that utilize experiential learning on topics related to sustainability grand challenges. We implemented these modules and courses in the curricula in our nine partner institutions, Arizona State University (ASU), Mesa Community College (MCC), University of Pittsburgh (UPitt), Community College of Allegheny County (CCAC), Chandler-Gilbert Community College (CGCC), Laney College (LC), Clemson University, Fresno City College, and Colorado School of Mines (Mines). We also evaluated the effectiveness of the modules and classes on student, faculty, and program performance. All materials developed (courses, modules, etc.) employed well-known experiential learning pedagogies and build on the teams' sustainability engineering educational expertise. Flexibility was built into the stand-alone course materials and modules to accommodate the resources of different faculty and facilitate the adoption of these courses across different universities.

The three stand-alone sustainability courses can be adapted for different levels of the undergraduate curriculum. We aimed to produce all of the materials that an instructor needs to begin teaching these courses, including: syllabus with ABET outcomes, sample course schedule, description and instructions for conducting experiential learning activities, lecture slides, homework assignments, sample course projects, exams, and pre- and post- course assessments. Some of the experiential learning activities in the stand-alone courses will utilize the modules that we will develop in our module approach; however, each course has unique experiential learning activities integrated throughout much of the entire class, often over the course of many weeks.

The modules were designed with the flexibility for faculty to utilize them in a number of different courses at different levels. Modules were designed to fit into approximately one week of lecture content. The modules designed in this project aim to provide everything an instructor needs for implementation: a summary of learning objectives (including ABET outcomes), lecture slides and notes, recommended readings, a homework assignment, experiential learning activity instructions, an example you-tube video to provide guidance on conducting the experiential learning activity, and module pre- and post- assessments. Modules were also designed to fit into a wide range of different engineering courses, from freshman engineering classes, to engineering ethics and business practices. The modules are: critical resources, energy audit, food desert, game design, IR for building physics, life cycling thinking, model UN, packaging, power grid, sustainability metrics, technology evolution, waste audit, and water footprinting. The modules are available on our website (www.sustainableengineeringed.org).

The engineering programs at each institution integrated sustainability into their curricula to different degrees. In addition to our original partner institutions (UPitt, ASU, MCC & Laney), we also implemented courses and modules into curricula at other schools, such as Clemson University, Colorado School of Mines, Chandler-Gilbert Community College (CGCC) and

Fresno City College. CCAC was also provided access to the green building course. UPitt implemented all three stand-alone sustainability courses (Y1, all three courses; Y2, all three courses; Y3, all three courses; Y4, all three courses, except GB moved to a graduate course; year 5, all three courses, except GB moved to a graduate course). The modules used in the courses were (**Table 1**): food desert, life cycle thinking, energy audit, game design. UPitt and ASU implemented all three courses, while Laney implemented the GB course. Modules were implemented at several institutions: Sustainable metrics module at ASU, the water footprint module at Chandler-Gilbert Community College and MCC, and the power grid, food waste, and food dessert module at Clemson, water footprint and sustainable metrics at Fresno City College. Numerous modules were used in the Civil Engineering Department at Clemson University. And LCA was taught at Mines. In addition, faculty outside of our institutions have implemented these modules. For example, we highlighted our modules in a workshop at AEESP in 2017; over 20 faculty at that workshop took our modules to use at their home institutions.

Table 1. Description of New Modules to be Developed in this Project

***Several modules have multiple, distinct variations**

Module	Description	Variations
Model UN	A card game guides students through a model UN. One card describes the country, a set of cards identifies strategies, and events cards that the UN must address are held by the instructor.	Cards will be created that address topics of feeding 9 billion people, C sequestration, managing the N cycle, information security
Life cycle thinking (LCT)	Students are given a product in class and asked to take it apart. Students then create a process flow diagram that includes life cycle flows of energy, materials, emissions.	Any type of product can be used (e.g. candy bar, small electronic, etc), enabling LCT in nearly any class related to materials, products. Advanced levels can quantify process flows.
Sustainability Metrics*	Students are asked to bring a green product to class. Students investigate what metrics make it green, how to quantify and benchmark metrics, how green metrics influence design	Any type of product with a green label can be used: students can bring them to class or faculty can provide to students. Assignment can be modified to evaluate metrics, redesign products
Energy-supply, demand, and transmission	Students are given M&Ms to represent a unit of energy. Students calculate energy conversions, losses during transmission as energy (M&Ms) moves from the resource to the point of use.	Students can practice multiple skills by using Matlab to solve and graph information from their game. Different types of energy production systems can be included, including renewables. Activity can evaluate changes in supply and demand.
Energy-renewables	Students play the flash game Super Energy Apocalypse by Lars A Doucet. Groups are tasked with different energy strategies for	Students can play remotely and tweet their progress. The module will also be designed to use the board game,

	developing the new world, and they must assess their impacts.	Power Grid by Rio Grande Games for a more tactile experience.
Packaging	Students disassemble packaging for a line of products, weigh and catalogue the different materials, evaluate the effect of packaging on product safety, transportation, and materials use.	Packaging can be from a variety of products (cookies, DVDs, etc.). Students can redesign the packaging, calculate emissions and costs of shipping, and optimize product packaging and delivery.
Technology Evolution	Students create a timeline of a products' evolution. The cell phone is a classic example: students identify the major changes in technology over time and predict the next generation.	The timeline can address the connections between social values and design decisions, the systems connected to the designs, the evolution of emerging technologies.
Sustainable Waste Management*	Students conduct a visual waste audit (e.g. watch and document what is disposed of in campus dining hall) and quantify how much waste ends up in different streams. Students determine where their waste goes, compare to alternatives.	The activity can be conducted either in or out of class to differing degrees of complexity; from simply discussing implications of waste management to calculating emissions from different manners of disposal (e.g. landfill, incineration)
C, water footprinting	Students use existing online tools to calculate either their carbon or water footprints. Students learn about embedded water, solutions for minimizing C and water emissions.	Students can be asked to compare the results from different tools, with the aim of critically evaluating information. Students can run the tool to test improvements.

Assessment and Evaluation

We divide measurable outcomes into three categories for evaluation: (i) Student-centered evaluation of learning outcomes for each module and course, (ii) Evaluation of faculty and institutional outcomes for the two different methods of course integration and (iii) Evaluation of outcomes from the four-year duration of the project. Outcomes from the classes and modules (outcome type i) were evaluated by comparing formative and summative survey responses from implementation of the proposed TUES 2 project to the survey responses from prior classes and to control classes (i.e. classes not using modules). In order to evaluate the use and effectiveness of the stand-alone course method and the module method (outcome type ii), we evaluated student performance in the individual courses and modules. We also compared products from students matriculating through the five engineering programs, from freshman course projects to senior design course projects. Finally, we will evaluate the success of our TUES 2 program (outcome type iii) by quantifying the continued use of our modules within faculty classes via faculty surveys.

The implementation of these courses and modules impacted the education of thousands of undergraduate students at our partner institutions as well as at many other universities who have adopted these modules. Key findings from the pre- and post-assessment module and course surveys found that students are motivated to learn about sustainability and engineering grand challenges. Faculty experienced significant barriers to including more sustainability and engineering grand challenges in their course content. Some common barriers include time

constraints to fit in new material, balancing the dilution of course fundamentals with the new material and resources to aid non-experts in sustainability.

Results from this work have been published in several journals, and we summarize the cumulative work in this presentation. First, evaluating the “Active Experiential Sustainable Engineering Module for Engineering Education,” results indicate students performed best cognitively when terms were given explicit definitions rather than implicitly, and signify one of the important components of the module is the use of active and experiential learning through with engineering students explores sustainability concepts of design for end-of-life, design for disassembly, and sustainable metrics by hands-on office chair disassembly (Dancz et al. 2017). “Assessment of Students’ Mastery of Construction Management and Engineering Concepts through Board Game Design” established the use of a Game Design Module as a way to assess students’ mastery of course content where students modify existing board games to teach players –i.e. their classmates– course content (Dancz et al. 2017). The results indicate that students can demonstrate mastery of concepts through design of their own board game and that instructors can assess student mastery through these student-designed games. Results show that using board game design as a method for assessing student retention of concepts improved student performance and increased student satisfaction. Next we look at “Utilizing Civil Engineering Senior Design Capstone Projects to Evaluate Students’ Sustainability Education Across Engineering Curriculum (Dancz et al. 2017).” This paper presents the development of a novel, holistic sustainability rubric and application to civil engineering senior design capstone projects to evaluate students’ sustainability knowledge at two institutions using a stand-alone course method to integrate sustainability into engineering curriculum. Rubric evaluation of student reports revealed that students’ performance in senior design projects is primarily driven by their instructor’s expectations; if sustainability is not a major deliverable, then students are less likely to integrate sustainability concepts that they learned from prior classes in their reports. To make sustainability a priority, the authors suggest that senior design project requirements should be updated to explicitly require holistic sustainability applications. In addition, instructors could approach raising sustainability expectations by engaging a sustainability expert as an advisor to the senior design course and/or utilizing a sustainability expert as project mentor. Results from the paper “Sustainable Engineering Student Cognitive Outcomes: Examining Different Approaches for Curriculum Integration” represents the culmination of our research comparing the stand-alone course approach to the module approach to teaching grand challenges and sustainability in Engineering (Ketchman et al. 2017). This study compares results from the application of a comprehensive holistic sustainability rubric assessment tool to three years of student projects in two stand-alone sustainable engineering courses and two senior design courses, intended to assess dissimilarities in student outcomes and locate causality, in the context of sustainability. T-test results indicate student projects in the stand-alone courses exhibited higher levels of cognition, a 119% increase in achievement of application, 330% increase in use of quantitative methods, and improved linkage of the three pillars of sustainability: economic, environment, and society. The authors present four potential factors contributing to discrepancies in student outcomes, offering strategic approaches to overcoming these barriers institutionally and nationally.

We also investigated faculty barriers and perspectives to adopting new sustainability curriculum (Burke et al. 2018). “Faculty Perspectives on Sustainability Integration in Undergraduate Civil and Environmental Engineering Curriculum.” This paper elucidates and explores faculty perceptions about the importance of sustainability in civil and environmental

engineering (CEE) education as well as methods for and barriers to its incorporation in CEE courses. Specifically, it presents results of a survey administered to faculty at two institutions as well as to attendees at an Association of Environmental Engineering and Science Professors (AEESP) preconference workshop. Findings show that most sustainability content is currently taught in the later years of undergraduate students' education while most faculty continue to employ traditional lecture-based teaching methods.

References Cited

- Allen, D., C. Murphy, B. Allenby and C. Davidson (2006). "Sustainable engineering: a model for engineering education in the twenty-first century?" Clean Technologies and Environmental Policy **8**(2): 70-71.
- Bielefeldt, A. R. (2013). "Pedagogies to achieve sustainability learning outcomes in civil and environmental engineering students." Sustainability **5**(10): 4479-4501.
- Bransford, J. D., A. L. Brown and R. Cocking (2006). "HOW PEOPLE LEARN BRAIN, MIND, EXPERIENCE AND SCHOOL (EXPANDED VERSION)." Education Canada **46**(3): 21-21.
- Burke, R. D., C. L. Antaya Dancz, K. J. Ketchman, M. M. Bilec, T. H. Boyer, C. Davidson, A. E. Landis and K. Parrish (2018). "Faculty perspectives on sustainability integration in undergraduate Civil and Environmental Engineering Curriculum." Journal of Professional Issues in Engineering Education and Practice **144**(3): 04018004.
- Dancz, C. L., M. M. Bilec and A. E. Landis (2017). "Active experiential sustainable engineering module for engineering education." Journal of Professional Issues in Engineering Education and Practice **144**(1): 04017011.
- Dancz, C. L., K. J. Ketchman, R. D. Burke, T. A. Hottle, K. Parrish, M. M. Bilec and A. E. Landis (2017). "Utilizing Civil Engineering Senior Design Capstone Projects to Evaluate Students' Sustainability Education across Engineering Curriculum." Advances in Engineering Education **6**(2): n2.
- Dancz, C. L. A., K. Parrish, M. M. Bilec and A. E. Landis (2017). "Assessment of Students' Mastery of Construction Management and Engineering Concepts through Board Game Design." Journal of Professional Issues in Engineering Education and Practice **143**(4): 04017009.
- Donovan, S. and J. Bransford (2005). How Students Learn: History, Mathematics, and Science in the Classroom, {National Academies Press}.
- Fox, M. A. and N. Hackerman (2003). "Evaluating and Improving Undergraduate Teaching in Science, Technology, Engineering, and Mathematics (Book)." Mathematics Teacher **96**(8): 604-604.
- Ketchman, K., C. L. A. Dancz, R. D. Burke, K. Parrish, A. E. Landis and M. M. Bilec (2017). "Sustainable Engineering Cognitive Outcomes: Examining Different Approaches for Curriculum Integration." Journal of Professional Issues in Engineering Education and Practice **143**(3): 04017002.

Educating Engineers for the post-COVID 21st Century

Paul G. Leahy¹, Dylan Furszyfer^{2,3}, Benjamin Sovacool³, Aoife M. Foley²

1. School of Engineering, University College Cork, Republic of Ireland
2. School of Mechanical and Aerospace Engineering, Queens University Belfast, Northern Ireland
3. Science Policy Research Unit (SPRU), University of Sussex Business School, University of Sussex, United Kingdom

Over a decade ago, two of the authors of this submission presented a paper entitled “Educating Engineers for the 21st Century” at the International Symposium for Engineering Education, held at this venue. We made some predictions of the demands that would be placed on engineering graduates in the following years and how the academy could best educate Engineers for a world characterised by rapid change, increased specialisation and economic uncertainty.

In this contribution, we reflect on the changes experienced in Engineering education in the past decade, and focus particularly on the unpredicted and rapid changes that have occurred due to the COVID-19 pandemic. Some trends in Engineering education that emerged in the past decade, such as the replacement physical labs with computer simulations, have accelerated as a result of the restrictions imposed in response to the pandemic. Other effects include increased individualisation of student effort and a shift away from group work. The previous trend we noted towards increased specialisation in Engineering education may have reversed, with a greater focus on more general degree programmes. Despite the rapid pace of technological and social change of the past decade, and the once-in-a-generation disruption of the pandemic, many of the concerns of ten years ago are still to the forefront for graduates entering the workforce today, for example, economic uncertainty, climate change and a requirement for career flexibility.

We draw upon the results of a survey of the career concerns of students in several institutions, to discuss the implications of the past decade’s developments for professional practice of the current generation of graduate Engineers, and propose educational approaches which will give society the engineers required to deal with today’s major societal challenges.

Approximating Professional Practice in a First-Year Engineering Curriculum: The Wind Turbine Maker Project

Paul G. Leahy, Connor McGookin, Hannah E. Daly

School of Engineering, University College Cork, Republic of Ireland

paul.leahy@ucc.ie

Abstract

In 2020, the Energy Engineering programme team at University College Cork undertook a redesign of the introductory first-year module in Energy Engineering. The aim was to introduce a more experientially-based learning experience and to allow first-year students greater opportunity to develop and demonstrate performance-based understanding. The key material change to the module was to incorporate design and group work in the first year of the programme. In the Wind Turbine Maker Challenge, groups of 4-5 students were tasked with designing and building a working wind turbine. Students were provided with kits comprising some basic elements of turbines including small generators and gearboxes and simple, flat blades. However, the focus of the exercise was on original design, particularly of the aerodynamic rotor components of the turbines. The participants had to source their own materials for the wind turbine rotors, and were encouraged to use recovered or recycled materials. Students were also asked to consider ethical aspects of wind energy generation. In developing this approach, the conceptualisation of teaching as setting up and facilitating students' performance was to the forefront. The formal classroom instruction was limited to only the core knowledge required to enable students to begin to consider suitable materials, geometries for their turbine designs through hands-on experimentation.

Survey feedback from students showed that they had strongly focussed on the environmental and sustainability aspects of the exercise. Students were asked what they thought the goal of the exercise was. Students' reported understandings of the main goal varied widely, for example "Learning how wind turbines work" and "Working as a team towards a common goal". However, all of the students' reported goals were compatible with the module's learning outcomes.

1 Introduction

When designing any new course it is useful to refer to the four dimensions of understanding (McCarthy, 2008a). In the case of introductory first-year Energy Engineering, the dimensions can be understood as follows:

- The knowledge base: here the relevant fundamental concepts in the discipline are the properties of materials, and the mechanisms of energy conversion
- The methods of disciplined reasoning and inquiry: in this case, the methods are discovery through supported experimentation and measurement
- The purposes of the discipline: this was strongly linked to ethical aspects – creating a renewable energy device has a benefit to society through mitigation of climate change and air pollution
- The forms of expressing understanding: energy engineers may express understanding through realisation of designs for systems or devices, or through oral and written communications

Adopting a Teaching for Understanding (TfU) / Universal Design for Learning (UDL) approach supports the development of the Engineering "Habits of Mind" (EHoM) described by (Lucas and Hanson, 2016), namely:

“systems-thinking”	seeing whole, complex systems and recognising linkages
“problem-finding”	examining needs and existing approaches and contexts
“visualising”	transitioning from abstract to concrete, trialling design solutions
“improving”	experimenting, designing, conjecturing; prototyping
“adapting”	testing, re-thinking, iterative design improvement, changing
“creative problem-solving”	applying techniques from other domains, critiquing

A design goal for new Engineering modules or sub-modules is to draw on as many as possible of the multiple intelligences and entry points to learning (Gardner, 1999; K, Davis, Christodoulou, Seider, & Gardner, 2011). These can be linked to the three principles of Universal Design for Learning (Rose and Gravel, 2010):

1. Multiple modes of engagement (via learners’ different intelligences)
2. Teachers must represent knowledge in different ways, and not only through traditional lectures. For example, videos or objects may be used.
3. Multiple means of action or expression, feeding into the Performance of teaching and learning, broadening the focus beyond traditional exam-based assessment.

Engineering students attend lectures and laboratories, write lab reports and assignments, and take end-of-term exams. There are particular expectations as to what constitutes a lecture or a laboratory. These form some of the “signature pedagogies” of engineering education (Shulman, 2005). Identification of the signature pedagogies, in particular the Engineering lab, allows their didactic conventions to be studied, and leads to consideration of how to make them accessible to a broader cohort of students, for example, by using multiple entry points, and engaging multiple intelligences. The performative element of learning for understanding is emphasised by McCarthy (2008b), who draws a contrast between an approach based on students’ application of their intelligence, or what might be termed “active understanding” where students are “encouraged to work things out for themselves”, and the representational approach where knowledge or facts are transmitted from teachers to students. Ethical issues are to the fore in contemporary engineering education. Howard Gardner advanced his definition of what constitutes professional work that is good: it must be “excellent in technical quality”, be “carried out in an ethical manner” and be “engaging and personally meaningful” (Gardner, 2008).

1 Background to the Wind Turbine Maker Exercise

Introduction to Energy Engineering & Engineering Ethics is an introductory module taken by all first year Engineering students at University College Cork. The previous design of the module was based on a traditional lecture format, with written essay assignments.¹ The previous learning outcomes of the module incorporated many aspects of the “GoodWork” philosophy (Gardner, 2008) and embrace the complexity of modern engineering practice (Shepphard *et al.*, 2008) while also incorporating the ethical requirements of the profession and building students’ teamwork skills. However, Shepphard *et al.* (2008) point out a deficiency in engineering education, namely that *“the lab is a missed opportunity: it can be more effectively used in the curriculum to support integration and synthesis of knowledge, development of persistence, skills in formulating and solving problems, and skills of collaboration. Design projects offer opportunities to approximate professional practice, with its concerns for social implications; integrate*

¹ Previous module descriptor for NE1001:

https://www.ucc.ie/admin/registrar/modules/?archive=y&archive_year=2018/2019&mod=NE1001

and synthesize knowledge; and develop skills of persistence, creativity, and teamwork. However, these opportunities are typically provided late in the undergraduate program” [authors’ emphasis].

2 Design of Exercise and Assessment

The module learning outcomes were rewritten to incorporate a new sub-module “Wind Turbine Maker”, to provide a more experientially-based learning experience. The following new learning outcomes were added:

- Describe energy conversion in a renewable energy device.
- Use basic principles of operation to design an energy conversion subsystem.
- Carry out a Risk Assessment.

Sheppard’s (2008) recommendation for the use of labs to “support integration and synthesis of knowledge, development of persistence, skills in formulating and solving problems, and skills of collaboration” was applied in the creation of the Wind Turbine Maker. The use of problem-based learning approaches has been shown to be beneficial in developing important skills such as an ability to work within a team, understanding of how to approach a design process and self-directed learning (Beagon et al., 2019). This paper places emphasis on the importance of design projects, for professional preparation. The key material change to the module was to incorporate *design* and *group work*.

In the Wind Turbine Maker Challenge, groups of 4-5 students were tasked with designing and building a working wind turbine. Students were provided with kits comprising some basic elements of turbines including small generators and gearboxes and simple, flat blades. However, the focus of the exercise was on original design, particularly of the aerodynamic rotor components of the turbines. The participants had to source their own materials for the wind turbine rotors, and were encouraged to use recovered or recycled materials. The Challenge had a strong emphasis on independent learning, as students were encouraged and facilitated to experiment with new materials and configurations. The exercise comprised the following elements:

- An Introductory Lecture on Wind Turbines & Aerodynamics including a Classroom Assessment Technique test (Angelo and Cross, 1993).
- An Introduction to Risk Assessment & Mini Assessment
- Ethics of Wind Energy Mini Seminar
- Three 2-hour practical Wind Turbine Maker Sessions focussing on:
 - Basic design, materials selection, group organisation
 - Technical feedback, initial testing, design refinement
 - Final design iteration, performance and robustness testing
- A public Grand Finale event organised at a large hall including high-speed tests using high-power fans on test benches, with electrical power output measurement meters for turbines, and expert judging on three criteria: technical achievement, use of sustainable materials and aesthetic design.

A deliberate decision was made to limit the amount of classroom instruction associated with the Wind Turbine Maker, and instead to allow students to explore the science and technology of energy conversion through hands-on design and experimentation. In developing this approach, the teaching was focussed on preparing students and facilitating their performance. The formal classroom instruction was limited to only the core knowledge required to enable students to begin to consider suitable materials, geometries for their turbine designs. This new exercise opened up a much wider set of Entry Points to Learning than the previous assessments of the module. The following entry points were explicitly featured:

- Narrational: via the written report
- Experiential: through the “doing”, physically making and testing the turbine
- Logical/Quantitative: The final performance of the turbine was quantitatively measured in the laboratory and in the Grand Finale event.
- Aesthetic: This was reinforced through the focus on visual design and appearance in assessment
- Participatory / Interpersonal: the Maker challenge was conceived as a group exercise.
- Foundational/Existential: only basic instruction on aerodynamics was supplied, instead students had to build prototypes and measure the results

Students were introduced to some ethical issues surrounding the siting of wind energy developments (i.e. concerns of people living near them such as noise, ecological, visual or health impacts), which they were asked to consider and report on. The requirement to use recovered and/or sustainable materials in the wind turbines also encouraged students to think of wastes as resources, and fostered circular economy thinking. The students had to produce a working wind turbine of their own design and incorporating recovered or recycled materials and they were incentivised by the offer of three group prizes for:

- Best overall design – this was based mainly on the measured technical performance of the turbine (i.e. maximum power production under controlled conditions)
- Best use of sustainable materials – students were briefed and encouraged to use recovered or ‘upcycled’ materials to design the wind turbine rotors.
- Best visual design.

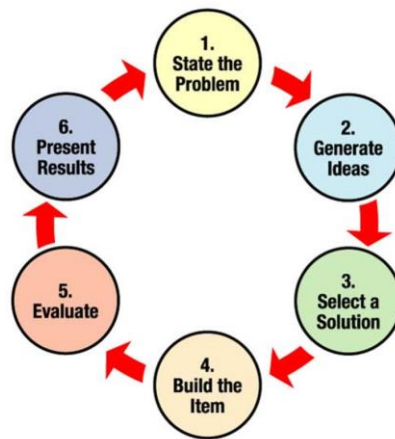

Figure 1. NASA Engineering Design Process (reproduced from (Rahman, 2014))

By incorporating these three strands into the competition, and the assessment, students were encouraged to approach the design assignment from different perspectives. This had the added benefit of leading students to consider ethical aspects of engineering design such as sustainability and environmental and social impacts, which would not normally be considered in an introductory first-year assignment.

The philosophy underlying the Wind Turbine Maker sub-module design was to hand over the freedom to students to “design, test, fail, improve, test again” and to facilitate them to achieve this, rather than to instruct them according to a set plan. This approach is grounded in practice, as it reflects the NASA Engineering Design Process (Figure 1). The Wind Turbine Maker Sessions were supported by student assistant demonstrators. The demonstrators and staff were available to students in the sessions to make

suggestions, offer advice and constructive criticism on aspects of the designs. The demonstrators also led the testing of the designs using portable fans to generate airflow.

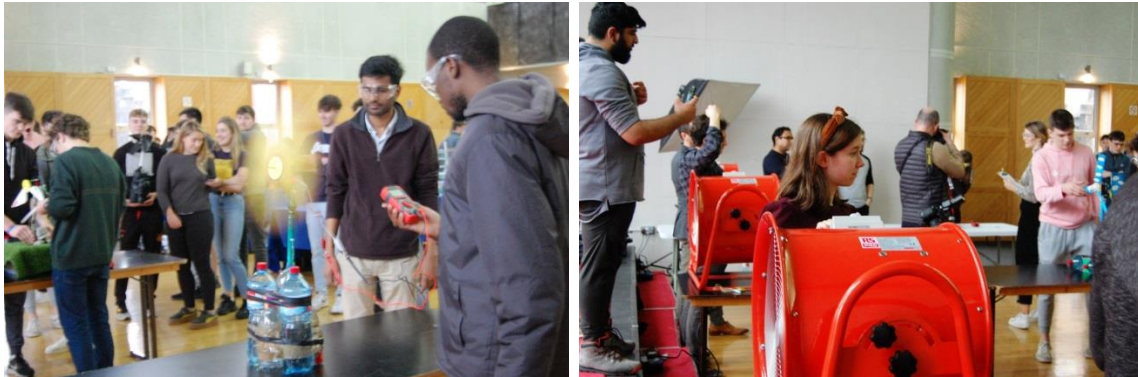

Figure 2. (a) Student turbine under test at Grand Finale event; (b) Test benches with fans at the Grand Finalé event

The different modes of assessments of the Wind Turbine Maker allowed for the three principles of UDL to be invoked. Students were tasked with producing an actual artefact, i.e. the wind turbine; a written report summarising their design process, and any challenges encountered and steps taken to overcome them; and a short video submission describing the turbine. In addition, students had to interact with the panel of judges and the testers on the Grand Finale day. The design of the assessment was such that technical and non-technical aspects were considered. This allowed multiple points of entry to the students, and allowed members of the groups with different preferred learning styles to contribute equally to the group design objective.

3 Results and Discussion

In Figure 3 some examples of the finished wind turbine designs produced by student groups are shown. A wide diversity of designs can be seen, in terms of the number of blades, the orientation of blades (horizontally or vertically oriented), and the shapes of the blades. Different approaches to stabilising the turbine are also apparent, and a wide variety of materials have been used. The freedom given to students to experiment resulted in this wide variety of finished artefacts. In addition, the students were only presented with the bare minimum information on wind turbine rotor designs prior to undertaking the Maker exercise, which meant that all the design choices embodied in the examples of Figure 3 had to be made through reading, group discussions, engagement with demonstrators, trial and error, and refinement.

The students were interviewed², as part of a short video documenting the event which provided some insights into their experiences of the exercise. Different points of entry to learning were evident, such as; enjoyment of the designing/building of the turbine, enthusiasm for a ‘hands-on’ practical exercise, or focus on the aesthetic appeal of their turbine designs. An indicative excerpt from a written student report show evidence of the student’s learning from the exercise.

“There are a plethora of airfoil shapes that could have been used for the blades. The airfoil design had to maximise lift and minimise drag. This task was achieved using a cambered airfoil. Cambered airfoils are non-symmetrical; this means that the camber line and the chord line are un-aligned. Cambered airfoils reduce the effect of drag, generate and maintain lift with greater ease making cambered airfoil an

² Energy Engineering Wind Turbine Maker Event, February 7th 2020
https://www.youtube.com/watch?v=DY9ULCgdN2k&ab_channel=MaREI

ideal shape for the blade. This shape was produced by cutting open soft drink cans, as they are made from aluminium which is extremely malleable and one hundred per cent recyclable and wrapped around the rotor plate which had three lollipop sticks were taped onto it.”

This excerpt shows a nuanced understanding of airfoil aerodynamics, far beyond what was outlined in the classroom. The student’s choice of aluminium soft drink cans is informed by a good basic understanding of the material’s relevant properties (malleability and good strength-to-weight ratio), and finally the reinforcement with lollipop sticks is evidence of an emergent understanding of structural mechanics and composite materials, again, none of which were taught in the classroom session.

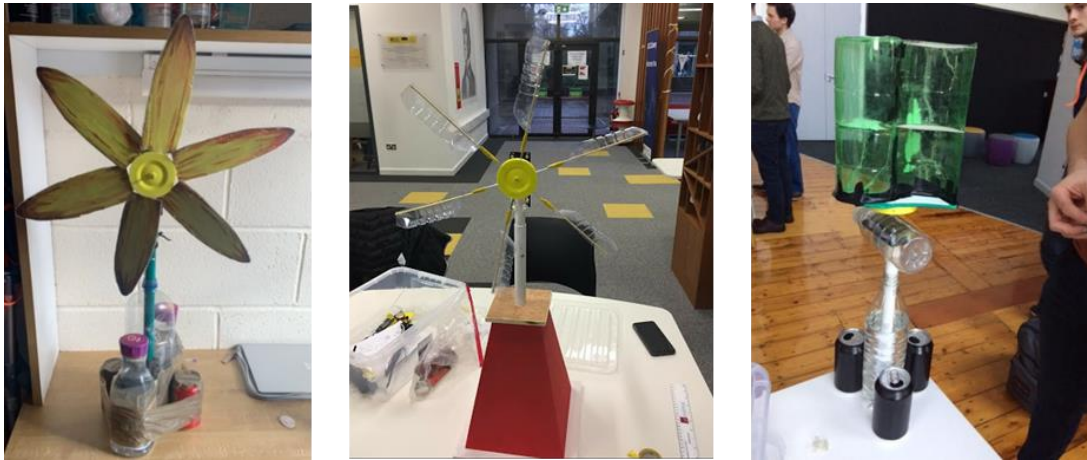

Figure 3. Examples of Student Wind Turbine Maker Designs

Students were asked to complete a voluntary and anonymous online survey after the completion of the Wind Turbine Maker exercise³. Of the 130 students in the cohort, 33 responded. The following questions were asked:

1. What do you think was the main learning goal of the Wind Turbine Maker exercise?
2. In your opinion, was the goal successfully achieved?
3. Which of the following subjects do you think the exercise related to?
Options: Electrical / Electronic Engineering; Structural/ Civil Engineering; Properties of Materials; Mechanical Engineering; Environmental Science/ Sustainability; Computing / ICT; Maths; Energy Conversion; Ethics; Other (specify)
4. How much did the exercise add to your understanding of the topics?
5. How much did the final assessment allow you to demonstrate your understanding of these topics?
6. How would you improve the Wind Turbine Maker exercise?

The design of the feedback questionnaire was open-ended in order to avoid leading questions and to solicit students’ genuine experiences of teaching and learning during the Wind Turbine Maker. There was a very diverse array of responses to Question 1. Students’ own understandings of the main goal were different, for example “Learning how wind turbines work” and “Working as a team towards a common goal”. However, all the declared goals were compatible with the module’s learning outcomes. Despite the wide range of responses to Question 1, there was good agreement that the goal was actually achieved. The

³ NE1001 Wind Turbine Maker Feedback, Google Forms, https://docs.google.com/forms/d/e/1FAIpQLSfDX89Hc-K5XwO4fZ2htA9JKDgL0M7PGj2K1uSDUildHtOUQA/viewform?usp=sf_link

mean score on the range 1-5 (where 1=not at all achieved and 5=strongly achieved) was 3.88, with a standard deviation of 0.78.

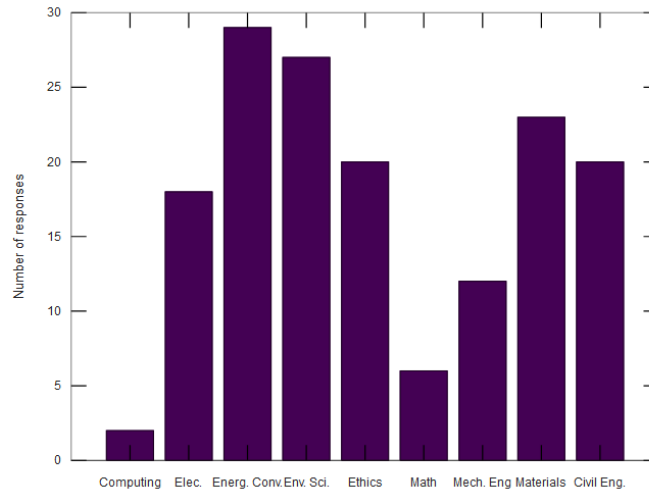

Figure 4. Student responses to question 3 in survey (multiple selections were allowed).

Several students responded that three maker sessions was not sufficient to fully develop and test their designs. The students would have appreciated more time to experiment and develop their understanding, but the exercise was heavily constrained by timetable factors as part of a busy first-year engineering semester. The responses to Question 3 were broadly in line with the authors' expectations, and with the module learning outcomes (Figure 4). The most-selected option was 'Energy Conversion' which was the main goal for student understanding in the Maker exercise, and aligned with the revised module learning outcomes. Students strongly focussed on the environmental and sustainability aspects in their responses. Ethics was weighted slightly less in the responses, and the individual Engineering disciplines such as Civil, Electrical, Mechanical Engineering received lower weights.

4 Conclusions

One of the main insights gained from the Enactment phase of the Wind Turbine Maker, was the level of student engagement and enthusiasm for the project. The sustainability aspect of the Wind Turbine Maker was taken to heart by the students. The students' suggestions for improvements to the exercise contain several useful points which could enhance the overall understanding of the topic. Based on the feedback from students and the insights gained during the exercise, the authors propose making adjustments to the learning outcomes in order to reflect a more student-centred approach and to help foster greater student understanding in the assessments:

- Describe energy conversion in a renewable energy device.
- Demonstrate team working skills
- Use basic principles of operation to design, test and refine an energy conversion subsystem.
- Assess the risks associated with construction and operation of energy conversion systems, and implement control measures.

The short duration of the exercise meant that it was difficult to gauge the long-term development of students' understanding. However it is held that the Wind Turbine Maker exercise allowed students to progress along the pathway to Understanding, not through the acquisition of subsidiary knowledge, which

Bass cautions against (Bass, 1999), but rather, through exploring, testing, failing, improving, failing again, and succeeding. In this way, it is hoped that the Wind Turbine Maker has played a small part in the formation of Engineering Habits of Mind for this cohort of students.

Acknowledgements

Materials and prizes for the Wind Turbine Maker exercise were provided thanks to a generous donation by Statkraft Ireland. This paper was developed from coursework submissions to the University College Cork Postgraduate Diploma in Teaching & Learning in Higher Education by Paul Leahy with feedback and guidance of the staff of the UCC Centre for Integration of Research, Teaching and Learning.

References

- Angelo, T. A. and Cross, K. P. (1993) *Classroom Assessment Techniques*. 2nd edn. San Francisco, USA: Jossey-Bass.
- Bass, R. (1999) 'The Scholarship of Teaching: What's the Problem?', *Inventio*, 1(1).
- Beagon, Ú., Niall, D. and Ní Fhloinn, E. (2019) 'Problem-based learning: student perceptions of its value in developing professional skills for engineering practice', *European Journal of Engineering Education*, 44(6), pp. 850-865.
- Davis, K. *et al.* (2011) 'The Theory of Multiple Intelligences', in Sternberg, R. J. and Kaufman, S. B. (eds) *Handbook of Intelligence*. New York: Cambridge University Press, pp. 485–503.
- EL Education (2020) *Helping all Learners: Entry Points*. Available at: <https://eleducation.org/resources/helping-all-learners-entry-points> (Accessed: 30 July 2020).
- Gardner, H. (1999) *The disciplined mind : What all students should understand*. New York: Simon & Schuster. New York: Simon & Schuster.
- Gardner, H. (2008) 'I. What is Good Work?', *The Tanner Lectures on Human Values*. Available at: https://tannerlectures.utah.edu/_documents/a-to-z/g/Gardner_08.pdf.
- Lucas, B. and Hanson, J. (2016) 'Thinking Like an Engineer: Using Engineering Habits of Mind and Signature Pedagogies to Redesign Engineering Education', *International Journal of Engineering Pedagogy*, 6(2).
- McCarthy, M. (2008a) 'Teaching for Understanding for Lecturers: Towards a Scholarship of Teaching and Learning', in *Emerging Issues II: Changing Roles and Identities*. NAIRTL / University College Cork, pp. 101–111. Available at: <http://eprints.teachingandlearning.ie/id/eprint/2912>.
- McCarthy, M. (2008b) 'The scholarship of teaching and learning in higher education: an overview', in Murray, R. (ed.) *Scholarship of teaching and learning in higher education*. London: Open University Press.
- Rose, D. H. and Gravel, J. W. (2010) 'Universal design for learning', in Baker, E., Peterson, P., and McGaw, B. (eds) *International Encyclopedia of Education*. 3rd edn. Oxford: Elsevier.
- Shepphard, S. D. *et al.* (2008) *Educating Engineers, Designing for the Future of the Field*. The Carnegie Foundation for the Advancement of Teaching.
- Shulman, L. S. (2005) 'Signature pedagogies in the professions', *Daedalus*, 134(3), pp. 52–59.

Closing the Circularity Gap Via Engineering Education for Circularity with a Whole Systems and Biomimetic Perspective

Ross A. Lee¹ and Karl Schmidt¹

¹Sustainable Engineering, Villanova University, Villanova Pennsylvania, USA

ross.lee@villanova.edu

Abstract

As reported at the World Economic Forum in Davos, Switzerland in January of 2019 only 9% of the world is circular (defined as the annual percentage of materials that are returned to the system vs. discarded as waste). It is estimated that the 91% that is not circular contributes to over 60% of global greenhouse gas (GHG) emissions along with an estimated 8 million tons of waste entering our oceans each year.

Villanova's focus on circularity in engineering education includes three graduate level courses: Sustainable Materials and Design, Biomimicry (defined as engineering solutions inspired by nature), and Sustainable Supply Chain, along with industry and grant sponsored class projects, MS and PhD level research. Four key fundamental learning themes emphasized include a whole systems STEEP (social, technical, environmental, economic and political) perspective; assurance that the performance and cost benefits of the incumbent linear solutions are understood, quantified, and rivalled in the circular solution; engaging the right subject matter experts, cross disciplines and stake holders; and ensuring that the right metrics are in place for the final recommended more circular systems.

Specific examples in this paper will include highlight projects from the above mentioned courses, circularity focused industry-sponsored class projects, Master's level research developing a closed loop system for converting food waste to a hydrochar material that re-enters the system for energy and other higher value uses, and PhD research on renewably sourced polymers for aircraft composites.

The challenges we face to move towards the circular economy from our current linear economy are daunting. We believe, however, that through the described collaborative engineering educational learning experiences for today's future leaders we will be able to make a significant impact.

1 Introduction

1.1 Background

The need to close the circularity gap was clearly articulated in the second Circularity Gap Report (Wit *et al.*, 2019) where at 9.1%, no significant progress had been made since the first report in 2018 (Wit *et al.*, 2018). In fact, this report went on to conclude that it would not be possible to achieve the Paris Agreement goal of limiting global warming rise to 1.5 degrees Celsius from pre-Industrial levels without closing this gap. At the World Economic Forum in Davos, Switzerland, in January of 2019, there was a focus on how to reverse the trend and close the 91% circularity gap to stop the >60% of greenhouse gas (GHG) emissions and over 8 billion tons of plastic leaking into oceans. This resulted in several initiatives including eliminating electronic waste, stopping plastic pollution, and establishing a new system for reusing packaging (WORLD ECONOMIC FORUM, 2019). At Villanova, we challenged ourselves to ensure that

our graduate program in Sustainable Engineering provided the education and tools needed for our students to do their part in closing this gap as future leaders for sustainable engineering solutions.

1.2 Approach

Develop the skills and capabilities needed to create more circular whole system solutions by analyzing both the benefits and issues with our current linear system and assessing and synthesizing more circular alternatives across a whole systems social, technical, environmental, economic and political (STEEP) perspective (Schmidt *et al.*, 2015) via curricula, company sponsored class projects and research (Lee, 2018). Specific examples in each of these areas will be described in the sections that follow. Pedagogic evidence for effectiveness has been provided by annual internal surveys that rate the elements in each area on a scale of 1 to 5 (5 highest). Scores for 2.1 and 2.2 consistently rank between 4 and 5 confirming their effectiveness and consistent with cited external examples of effectiveness. In sections 2.3 and 3, less rigorous assessments have confirmed effectiveness via student and company feedback of application to the circular economy.

2 Sustainable Engineering Graduate Courses that Drive Circularity

2.1 Course Title: Sustainable Materials and Design

2.11 Key Elements that Drive Circularity:

- **Individual Project Based Learning:** In this project based course, each student picks a material intensive area of livelihood that they are passionate about and would like to see an improvement in circularity and sustainability. Three individual projects, equally spaced throughout the semester and culminating in a 12 to 15 detailed and footnoted slide presentation, are then completed. The high internal survey rating for this area (section 1.2) is consistent with external reports (e.g. Blumenthal *et al.*, 1991) that affirm the improved learning experience from individual projects that students have a keen interest and passion in.
- **Understanding the Functional Benefits of the Incumbent Materials:**
The first section of the course focuses on the functional benefits and issues with existing materials. This is a key element that differentiates this approach to sustainable materials and circularity. Typically, courses focus first on the need and then on potential ways to achieve circularity (e.g. COURSERA, 2020) without a detailed analysis of the performance that must be achieved to rival the linear take-make-waste incumbent. In their comprehensive report on the Circular Economy, the Ellen MacArthur Foundation and McKinsey recognize that closing the functional gap between circular and linear materials is a critical innovation need, not only for future material suppliers, but also for the institutions conducting the research and education (EMAF, 2012). This first section focuses on the established performance of the materials that are part of our linear system today from a whole systems STEEP perspective (see below) both in the lecture content and in the first project assignment. For example, the awesome process capability to achieve 300 nm thick free-standing polyethylene naphthalate film is demonstrated in class by providing a sample and describing the biaxial stretching process capability of today's polyester film industry that enabled this achievement (Forrest *et al.*, 1998, Gardner *et al.*, 1999. see Figure 1).

It is only by thoroughly understanding the value and performance of the incumbents that alternatives for circular systems can be selected or designed with any hope of displacement.

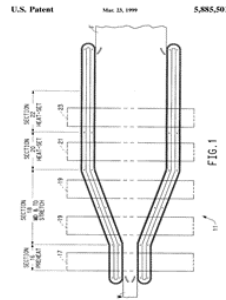

Figure 1 Schematic of Linear Motor Accelerated Simultaneous Biaxial Ultra-Thin Film Stretching

- Whole Systems STEEP Assessments for More Circular Alternatives and Designs:** The second section of the course focuses on understanding more circular and sustainable alternatives and the third section focuses on designing new circular and more sustainable material solutions. All of the alternatives and new designs are assessed from a whole systems, STEEP perspective (Schmidt *et al.*, 2015) that includes the social (especially producer and user safety and health), technical (especially functional performance as mentioned above), economic (especially the ability to achieve cost parity with the incumbent), environmental (including quantitative estimates of the net environmental benefits (e.g. reduced GHG, waste, pollution, water use, etc.) and political (e.g. regulatory drivers such as REACH and TSCA) dimensions. Circularity knowledge, skills and capabilities are developed through assessing these whole system dimensions for renewably sourced, biodegradable, recyclable or durably reusable more circular and sustainable alternatives and designs, and comparing them with the whole systems STEEP assessment of the incumbent material or material system. Examples of commercially viable circular materials and circular material designs are provided via class lecturers including the production of 1,3 propane diol from glucose for renewably sourced and recyclable carpets (DuPont, 2020) and the production of a renewably sourced and biodegradable thermoplastic starch to displace polystyrene in chocolate trays (Plantic, 2020).

2.12 *Sustainable Materials and Design Student Project Example:* Figures 2 thru 4 show slides from a student project that assessed a more circular material solution for personal care packaging based on renewably sourced bamboo and PLA. Note the use of Ashby plots comparing material performance in two dimensions via the CES EduPack software tool by Granta Design (CES EduPack, 2019), the whole systems STEEP analysis, and the conclusion that recognizes the trade-offs and what must be done to achieve the more circular solution.

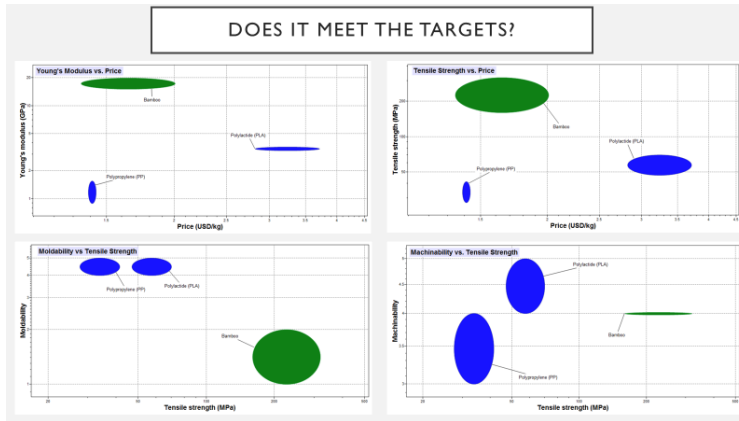

Figure 2

		STEEP ASSESSMENT	
		Positive	Negative
Social		Consumers are turning towards more sustainable materials, such as those that are reusable or reduce material usage, so these products can meet that market.	Consumers may be wary of moving away from materials they are comfortable with using. Needs to be education on how to correctly dispose of composite for composting.
Technological		Pods: polyvinyl alcohol is already being used in other applications, so it is a proven technology. Packaging: using bamboo and PLA together can minimize negative aspects and highlight positive performance.	More research needs to be done to determine the ideal composite ratio of material and test for cosmetic and personal care applications. To implement 3D printing, more research needs to be done on the filament and scale up abilities.
Economic		The pods could reduce costs to the consumer because they are only buying a small amount of material compared to the full bottle of mostly water. The packaging will be cost effective because bamboo can balance the cost of PLA and as PLA research improves, the cost will decrease.	It could take time for the PLA costs to be competitive. The research that still needs to be done could be cost prohibitive. Need to determine cost effectiveness of setting up a subscription business strategy for pods.
Environmental		Bamboo has a lower embodied energy in primary production compared to PP, PET, and PMMA. PLA has a comparable footprint to PP and PET but uses less water. Moving to a pod drastically reduces the material usage and transportation impacts due to lower shipment weight.	PLA has comparable embodied energy to PET, PP, and PMMA so there is not a large improvement in production. Bamboo is water intensive. While polyvinyl alcohol biodegrades, it is not a bio-based plastic.
Political		Moving away from feedstocks from fossil fuels can be a political benefit in that there will be less reliant on oil which is a source of conflict in many areas. As oil reserves decrease, less reliance will lead to less conflict and price increase.	There needs to be a lot of regulation for sustainable forestry and farming management for bamboo to ensure the materials are truly renewable. Without more of a push to move to these materials or at least increase recycling, there is less incentive to move away from plastics. Standards need to be developed to ensure safe practices are followed with the new composite.

Figure 3

- ### CONCLUSIONS AND RECOMMENDATIONS
- Moving to pods for liquid products can save a lot of material usage and fossil fuel based plastic
 - It is successful in other areas: detergents, cleaning supplies
 - Gives the same end result for the consumer using the product once it is dissolved in water
 - While bamboo and PLA both have very positive attributes, they have negatives as well
 - These negatives can be minimized by creating a composite based on both materials
 - Improves performance while minimizing cost compared to PLA with no other material
 - 3D Printing and additive manufacturing could be very beneficial to the packaging sector
 - Fast prototyping, customization, reduction in waste
 - Bamboo/PLA filament already being studied
 - Overall, re-design must start from the beginning and involve thinking outside the box

Figure 4

2.20 Course Title: **Biomimicry**

2.21 Key Elements That Drive Circularity

- This course is organized in exactly the same manner as the Sustainable Materials and Design course and includes the same elements of:
 - **Three individual equally spaced projects** – but in this case students choose from thirteen service systems of life (Spohrer, 2014) and pick one that they are most passionate about improving.
 - **Understanding the good and the bad** - The focus in the first project and first part of the course is again on understanding the awesome benefits of today's systems that must be preserved as well as the issues that must be changed from a whole systems STEEP perspective.
- **Applying learnings from nature:** The second and third parts of this course focus on learning from nature's circular systems and applying those learnings to create more circular and sustainable biomimetic system designs. To accomplish this, students are taken on field trips to the Philadelphia Zoo and to Longwood Gardens to see first-hand how nature provides solutions. In preparation for this a workshop on form vs. function (Kleinke, 2012) and TRIZ (Weaver, 2012) is conducted to provide the tools to understand the current and natural systems in terms of the key functional performance needed and how that is achieved in nature. Lectures focus on understanding how nature provides ecosystem services, materials, energy, information storage, etc. Examples of implemented commercial biomimetic systems are also presented. The final student project provides a more circular and sustainable biomimetic system design assessed from a whole systems STEEP perspective to show the net impacts and implementation strategy.

2.22 Biomimicry Student Example The student project shown below focused on developing a more sustainable and circular biomimetic solution to heat and cool buildings. Building from how termite mounds keep a constant temperature and also finding that bricks can be comprised of natural materials (even waste) the student designed a biomimetic system to improve energy efficiency and reduce waste. Figure 5 shows her proposed solution and Figure 6 highlights her comprehensive STEEP assessment of the benefits.

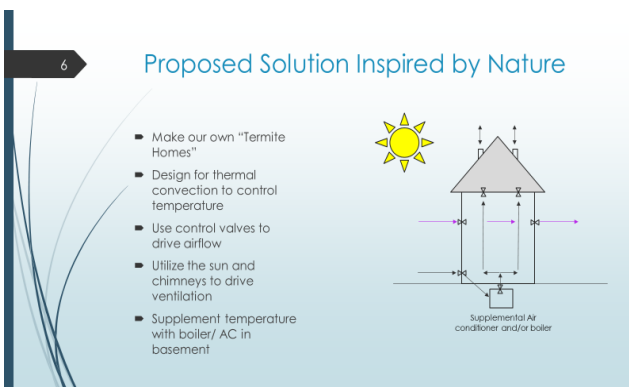

Figure 5 Proposed Solution

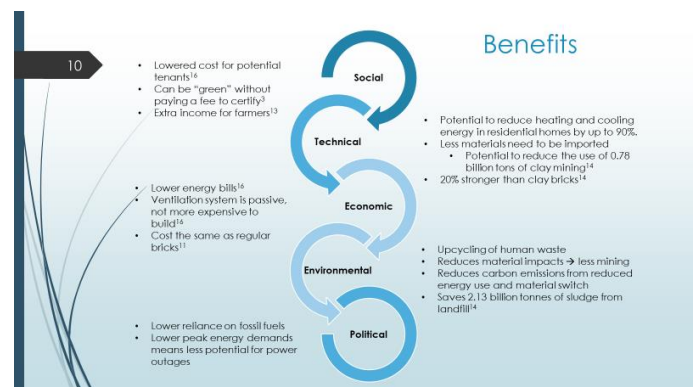

Figure 6 STEEP Assessment

2.3 Course Title: Sustainable Supply Chain

2.3.1 Elements that Drive Circularity

We explore circular economy sustainability principles and practices through a supply chain management perspective. The focus is on how companies design, build and implement their supply chains to deliver products and/or services while seeking to optimally balance organizational and performance outcomes across economic, environmental and social criteria. The curriculum follows the Supply Chain Operations Reference model (SCOR) (ASCM, 2020) including Plan, Source, Make, Deliver, and Return and addresses "upstream" suppliers, planners, manufacturers, distributors through "downstream" customers. Application of practical tools, case studies, group projects as well as lectures by industry practitioners are used to foster better understanding of this growing global business topic.

Key circular economy principles highlighted include:

- Design out waste by identifying and designing out negative externalities, such as water, air, and noise pollution, extraneous packaging materials
- Shift to renewable energy resources away from fossil-fuel based sources
- Use systems thinking concepts to preserve and enhance natural capital - by controlling finite stocks and balancing renewable resource flows
- Move toward eco-effectiveness (from one-way linear flow of materials to cyclic, cascading steps by circulating products, components, and materials at the highest utility at all times in both technical and biological cycles)

Using these design principles, students apply a business model framework (Accenture, 2014) outlined in Figure 7 to case study supply chain projects where they recommend improvements. The recommended alternatives and new designs are also assessed from a whole systems, STEEP perspective (Schmidt *et al.*, 2015). External reports (Moraga, G., *et al.*, 2019) have affirmed the importance of holistic measurement evaluation (i.e. STEEP framework) to address Circular Economy systems, rather than a separate metric.

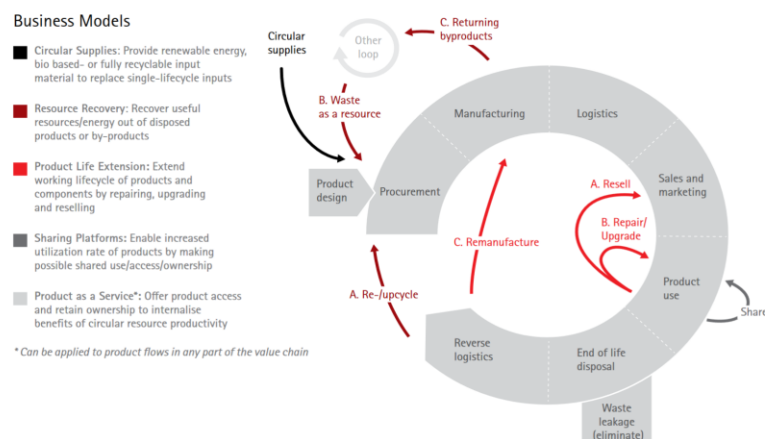

Figure 7 Circular Economy Models for Sustainable Supply Chains (from Accenture, 2014)

3. Research Examples. As reported previously, (Lee, 2018), circularity, renewably sourced energy and sustainable materials are three of the top five areas of sustainable engineering research focus. Figure 8 shows over 30 past and current company sponsored class, Master thesis and PhD research projects on closing the circularity gap. Highlighted in the circles are examples that include a class project to help a raw

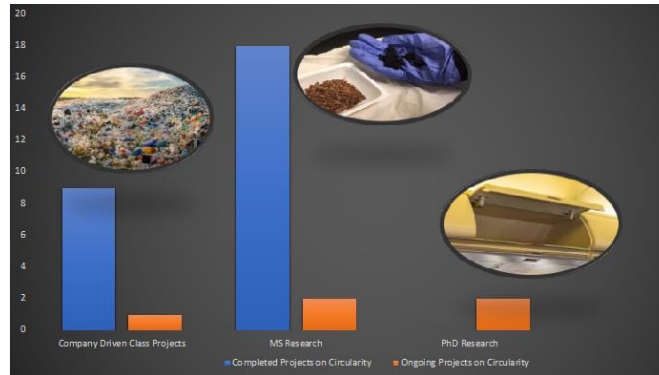

Figure 8. Research Examples

material provider improve recycling, a master thesis project to convert food waste into a hydrochar product for energy recovery or higher value use, and a PhD project to renewably source composites.

4. Conclusion. Our educational processes to provide the knowledge skills and capabilities in our graduate students to best equip them as future leaders to close the circularity gap can best be summed up as:

- Having students pick areas they are passionate about and focus first on understanding the benefits that must be preserved and rivalled by the more circular solution
- Assessing alternatives and more circular and sustainable designs from a whole systems STEEP perspective to ensure that the improved solution provides an overall net benefit across all these dimensions
- Engaging the right subject matter experts, disciplines, collaborators and stakeholders in classes, projects and research to achieve the highest quality outcome and richest learning experience.

References

Accenture. 2014. *Circular Advantage Innovative Business Models and Technologies to Create Value in a World without Limits to Growth*. https://www.accenture.com/t20150523t053139_w_us-en/_acnmedia/accenture/conversion-assets/dotcom/documents/global/pdf/strategy_6/accenture-circular-advantage-innovative-business-models-technologies-value-growth.pdf

ASCM. 2020. *Supply Chain Operations Reference (SCOR) model*. <https://www.apics.org/apics-for-business/frameworks/scor>

Blumenthal, P. C., Soloway, E., Marx, R. W., Kracjik, J. S., Guzdial, M., & Palincsar, A. 1991. Motivating Project-Based Learning: Sustaining the Doing, Supporting the Learning. *EDUCATIONAL PSYCHOLOGIST*, **26**, 369-398.

CES EduPack software, Granta Design Limited, Cambridge, UK, 2019

COURSERA. 2020. *Circular Economy - Sustainable Materials Management*. <https://www.coursera.org/learn/circular-economy>

DUPONT sorona®. 2020. *The Sorona® Story*. sorona.com/our-story/

Ellen MacArthur Foundation 2012 *Towards the Circular Economy: Economic and Business Rationale for an Accelerated Transition*.

<https://www.ellenmacarthurfoundation.org/assets/downloads/publications/Ellen-MacArthur-Foundation-Towards-the-Circular-Economy-vol.1.pdf>

Forrest, A. W. Jr., Heyer, D. E. Jr., Jolliffe, C. E., US Patent 5753172A assigned to DuPont.

Gardner, D. K., Paoletti, K. P., Gohil, R. M., Forrest, A. W. Jr., US Patent 5885501A currently assigned to Brueckner (initially assigned to DuPont).

Kleinke, D., Weaver, J. & Lynch-Karis, T. 2012. A Function Based Taxonomy to Connect Engineering Design to Biological Solutions. *In: Open 2012: NCIIA 16th Annual Conference. Mar. 21-24, San Francisco, Cal.*

Lee, R. A. 2018. Overview of a Whole Systems Multidisciplinary Sustainable Engineering Research Program. *In: 9th International EESD Conference Proceeding June 3-5, Glassboro, New Jersey*

Moraga, G., Huysveld, S., Mathieux, F., Biengini, G. A., Alaerts, L., Van Acker, K., de Meester, S., & Dewulf, J. 2019. Circular Economy Indicators: What do they measure? *Resources, Conservation and Recycling*, **146**, 452-461.

PLANTIC. 2020. *Chocolates*. <http://www.plantic.com.au/markets/chocolates>

Schmidt, K., Lorenz, W., Lee R., & Singh, P. 2015. Use of STEEP Framework as Basis for Sustainable Engineering Education. *In: 7th International Conference on Engineering Education for Sustainable Development, June 9 -12, Vancouver, British Columbia.*

Spohrer, J., 2015. Educating Service Innovators. *In: 5th International Conference on Applied Human Factors and Ergonomics. July 19-24, Krakow, Poland.*

Weaver, J. & Kleinke, D. 2012. Extending the TRIZ methodology to Connect Engineering Design Problems to Biological Solutions. *In: Open 2012: NCIIA 16th Annual Conference. Mar. 21-24, San Francisco, Cal.*

Wit, M., Hoogzaad, J., Ramkumar, S., Friedl, H., Douma, A. 2018 (January) *The CIRCULARITY GAP REPORT: An analysis of the circular state of the global economy*. Circle Economy.

Wit, M., Hoogzaad, J., Ramkumar, S., Friedl, H., Douma, A. 2019 (January) *The CIRCULARITY GAP REPORT: Closing the Circularity Gap in a 9 % world*. Circle Economy. Published as part of the Platform for Accelerating the Circular Economy (PACE).

WORLD ECONOMIC FORUM. 2019. *World Economic Forum Annual Meeting 2019 Closes with Initiatives to Address Global Problems*. <https://www.weforum.org/press/2019/01/world-economic-annual-meeting-2019-closes-with-initiatives-to-address-global-problems/>

Strategic implementation of education for sustainable development within the industrial engineer curriculum

N. Llaverias¹ and G. Reyes¹

¹IQS School of Engineering Universitat Ramon Llull, Barcelona, Catalunya, Spain
nuria.llaverias@iqs.url.edu

Abstract

The main objective of this presentation is to validate a methodology to address education for sustainable development within the industrial engineer curriculum that will define the content, skills and learning methods in a process of continuous improvement and compatible with the national curriculum regulations for the Bachelor and Master of the IQS School of Engineering.

In order to validate the teaching methods and their implementation the stakeholders, industry, public authorities and academia has been asked. A previous research has set the survey content. The results had determined the main skills to develop their work, to what extent have these skills the new graduates, and the areas we should consider now to move towards a sustainable development.

The questions to the experts were set in three groups. In the first group of questions they asked to assign the order of relevance to the categories: Environmental aspects, Resources scarcity, Social Impact, Cultural & Values aspects, Future generations, Unbalances, Technology, Economical aspects, Educational aspects, Actors and stakeholders to advance towards sustainable development.

In the second part of the survey the experts had decided the relevance of related competencies, to prepare graduated people to the demands of the professional market and the level the graduate achieve on these competencies.

The third question group was related to the curriculum and how must be the sustainability criteria be included within the engineering curriculum (degree + master). There are defined three options: 1) embedded the sustainable concepts in the subjects, 2) show recent real cases, 3) develop projects.

The panel of experts has been composed by public authorities of the administration and professional institutions, senior Engineers, IQS engineers and multidisciplinary experts.

Finally, the survey's conclusions have been applied in the curriculum in concordance with the Project P-15 Environmental Sustainability IQS of 2017-2020 Strategic Plan and the ABET Program accreditation

1 Introduction

This research was conducted for the curriculum in industrial engineering within the framework that defines the implementation of the Bologna Declaration on Higher Education in Spain. It was developed for the Bachelor and Master's degree program in Industrial Engineering at IQS School of engineering, federal member of the University Ramon Llull (URL). Both engineering programs are following the ABET Program accreditation.

The students of the Industrial Engineering B. Eng. must complete the ECTS credits of the program of studies distributed as follows: 212 Required, 10 Elective, 6 Practicum and 12 Final Degree Project. According to the Spanish regulations (Decree CIN/351/2009, of 9 February), the different credits are distributed among the following modules:

Table 1: Distribution of credits of the Industrial Engineering B. Eng.

Categories	Description	ECTS	TERMS
M1	Basic Formation	60	1-2
M2	Core Topics of Industrial Engineering	66	3-7
M3	Specific Technology	78	3-8
M4	Professional Skills	24	5-8
TFG	Final Degree Project	12	8

It should be noted the cross-disciplinary of content taught in the program, covering different areas of engineering as required by legislation in Spain. It is mandatory to obtain professional skills as an engineer and to keep a close link with the needs of the industry. The Bachelor degree enables access to the official studies of the Master, as provided Royal Decree RD 1393/2007, of 29 October, which establishes the planning of official university education.

All students registered in the Industrial Engineering MS program (*Plan 2012*) take **120** credits divided into two academic years. These 120 credits are distributed in 60 credits required (*Obligatorias*, R: Required), 30 credits electives (*Optativas*, E: Elective), 14 of there are electives form specialization (*Optativas de especialidad*, SE: Selected Elective) and 30 credits that corresponds to the Master's Thesis.

In summary, it can be described that the Bachelor and Master's degree qualifies to design, develop, implement, improve, solve and manage systems, products and processes in various industrial fields and in interdisciplinary teams, and to communicate knowledge and conclusions in an environment sustainable and responsible, and organizing and planning projects and human teams.

All this thanks to the skills acquired that allow graduates know and apply knowledge of science and technology to engineering practice, understand the impact of engineering on the environment and sustainable development of society, incorporate new technologies and engineering tools in their professional activities and ability to generate new ideas, among others

The analysis of the Spanish degree and Master, its regulations and outcomes, and analysis of the learning styles of our students, permit develop a proposal for embedding sustainability in the industrial Engineering curriculum according to the learning styles of actual students as individuals. (De Graff, E, 2006) (Wals, A.E.J.2014)

The IQS School of Engineering is developing the IQS 2017-2020 Strategic Plan. There have been defined four Strategic pillars. The P-15 Environmental Sustainability IQS is included in the pillar named "Comprehensive training and social and environmental compromise".

The Project's objectives are to continue to increase of the sensitivity of IQS for ecology and sustainability, in order to achieve an institution committed to sustainability and the environment in the framework of the objectives pursued by the global project HEST – High Education for Social Transformation, which essentially proposes what should be the contribution of Universities to help transform society.

2 Objectives

The main objective of this presentation is to validate a methodology to address education for sustainable development within the industrial engineer curriculum that will define the content, skills and learning methods in a process of continuous improvement and compatible with the national curriculum regulations for the Bachelor and Master of the IQS School of Engineering.

In order to validate the teaching methods and their implementation the stakeholders, industry, public authorities and academia has been asked. A previous research has set the survey content. The results had determined the main skills to develop their work, to what extent have these skills the new graduates, and the areas we should consider now to move towards a sustainable development.

Finally, the survey's conclusions would be applied in the curriculum in concordance with the Project P-15 Environmental Sustainability IQS of 2017-2020 Strategic Plan and the ABET Program accreditation (Leal Filho et al. 2019)

3 The Survey development

The survey was conducted in the first half of 2017. An expert panel of employers, representatives and academy members, teachers and management positions was mailed. Thirty responses were received from the 50 requested. In the first part of the survey they were asked to indicate their current position, their degree and the year of graduation. Table 2 shows the percentages of responses according to the year of graduation.

Table 2: Distribution of responses based on graduation year

Elapsed from graduation	Graduation year	Percent
< 10 years	2010-2019	15,38%
10 a 20 years	2000-2009	30,77%
20 a 30 years	1990-1999	23,08%
30 a 40 years	1980-1989	19,23%
> 40 years	- 1979	11,54%

Since a validation was sought to be able to implement within the curriculum of the industrial engineer it is important to indicate that the majority of professors in the industrial department and the teaching managers (80%) were obtained.

The survey was organized into three parts with the aim of answering the following three questions. What should be done? What skills are required? and how should they be included in the curriculum?

3.1 *What should be done? Actions to advance towards a sustainable development*

In the first group of questions they asked to assign the order of relevance to the categories: Environmental aspects, Resources scarcity, Social Impact, Cultural & Values aspects, Future generations, Unbalances, Technology, Economical aspects, Educational aspects, Actors and stakeholders to advance towards sustainable development. (Segalàs, Ferrer-Balas, and Mulder 2008)

Table 3: The categories to advance towards sustainable development in order of relevance

Categories	Description	Average
1	Environmental aspects	8,3
2	Resources scarcity	7,83
3	Social Impact	6,6
4	Technology	6
5	Education aspects	5,47
6	Unbalances	4,77
7	Future generations	4,43
8	Cultural & Values aspects	4,33
9	Economical aspects	3,87
10	Actors and Stakeholders	3,4

Table 3 results shows that it is considered essential take care of the environmental aspects and the scarcity of natural resources being the less important the economic aspects and those of agents and employers. In an intermediate position we find social impact, technology and education aspects strongly related to the university.

3.2. Which skills are required? Study of the related competencies and the level the graduate achieve on these competencies

In the second part of the survey the experts had decided the relevance of related competencies, to prepare graduated people to satisfy the demands of the professional market and the level the graduate achieve on these competencies.

The Catalan Agency for University Quality (AQU) collects the results from all the Catalan universities and produces a public report. The current report is in preparation. The survey carried out includes information about the graduate's profile, the skills and competences acquired, the personalized attention and the facilities and services. Its main goal is obtaining valuable information for the evaluation, being coherent with the Educational Objectives (AQU 2014). For future research, the content of the survey used the competency structure set out in the AQU Studies.

The experts had to evaluate from 1 to 5 the skills defined by the importance they have for an engineer in the development of their work and then they had to answer to what extent the recent graduates have these competencies. The position 1 indicated the less important and the skills not acquired, as well as the position 5 defined the most important and the best acquired. Table 5 shows the percentage in each position.

The competences with higher percentage were "Develop and structure ideas and proposals in a creative way and with critical reasoning" (57,69%), "Manage the new situations". "Develop technical projects considering the impacts, risks and social and the environment" (50%) and "Demonstrate an understanding of the importance of professional ethics and the consideration of all parties involved" (50%)

In the other hand "Know the strategies to minimize the environmental and social impacts of a project" (15,38%). "Communicate ideas and efficient proposals related to sustainable development". (15,38%) and "Manage the new situations". (19,23%) are considered of little importance

Taking account to the difference between how important is considered a competence with the extent that the recent graduates have acquired competences the biggest differences are in " Know the strategies to

minimize the environmental and social impacts of a project”(a difference of -76,93%)”Manage the new situations.” with a difference of -69,24% i “Develop and structure ideas and proposals in a creative way and with critical reasoning” with a difference of -61,41%

The competence “Demonstrate an understanding of the importance of professional ethics and the consideration of all parties involved “is the one with less differenced with a 23,08%

Table 5. Competencies for sustainable development (1. Nothing important and nothing acquired, 2. Little important and little acquired, 3. Slightly important and slightly acquired, 4. Quite important and quite acquired, 5. Extremally important and extremally acquired.

		1	2	3	4	5
Disciplinary contents	1. Have acquired advanced knowledge that allow to understand the challenges of sustainable development related to the practice of engineering.	0,00 0,00	0,00 19,23	15,38 50,00	65,38 30,77	19,23 0,00
	2. Consider knowledge of different engineering disciplines to achieve objectives of sustainable development in the practice of engineering.	3,85 15,38	3,85 34,62	15,38 26,92	50,00 23,08	26,92 0,00
Cognitive outcomes	3. Use an approximation holistic and systematic to explore solutions to complex problems.	3,85 3,85	0,00 19,23	26,92 53,85	50,00 23,08	19,23 0,00
	4. Develop and structure ideas and proposals in a creative way and with critical reasoning	0,00 0,00	0,00 19,23	3,85 46,15	38,34, 34,62	57,69 0,00
	5. Know the strategies to minimize the environmental and social impacts of a project	0,00 3,85	0,00 19,23	7,69 61,54	69,23 15,38	23,08 0,00
	6 Develop technical projects considering the impacts, risks and social and the environment	0,00 3,85	0,00 11,54	3,85 46,15	46,15 38,46	50,00 0,00
Personal Management outcomes	7. Manage the new situations.	0,00 11,54	0,00 19,23	11,54 50,00	34,62 19,23	53,85 0,00
Instrumental s outcomes	8. Communicate ideas and efficient proposals related to sustainable development.	0,00 3,85	3,85 34,62	30,77 46,15	50,00 15,38	15,38 0,00
Interpersonal outcomes	9. Working with others as members of a multidisciplinary team with opinions that do not have to coincide with the own.	0,00 0,00	0,00 23,02	3,85 34,62	57,69 42,31	38,46 0,00
	10. Working with others in a multilingual environment and different cultural backgrounds.	0,00 0,00	0,00 23,02	0,00 34,62	76,92 47,31	23,08 0,00
	11. Facilitate the participation of all parties involved in the decision-making process during the development of my projects	0,00 0,00	0,00 15,38	11,54 38,46	53,85 46,15	34,62 0,00
	Attitude and ethical professional.	12. Demonstrate an understanding of the importance of professional ethics and the consideration of all parties involved.	0,00 3,85	0,00 7,69	11,54 23,08	38,46 65,38
	13. Identify the potential challenges, risks and the consequences of how the engineering practice impacts on society and the environment	0,00 3,85	0,00 23,08	11,54 42,31	50,00 30,77	38,46 0,00
	14. Guide of ethical and responsible professional activity in the framework of organisations, administrations, companies or teams	0,00 3,85	0,00 23,08	15,38 30,77	53,85 42,31	30,70 0,00

3.3 How should be included the sustainability criteria within the engineering curriculum

The third question group was related to the curriculum and how must be included the sustainability criteria within the engineering curriculum (degree + master). There are defined three options: 1) embedded the sustainable concepts in the subjects, 2) show recent real cases, 3) develop projects.

The experts were asked to indicate 0,1,2, or 3 to each of the three levels assessing how you would have liked them to be incorporated into your studies and identify when they should be placed. (the higher the most suitable value).

Table 6. Importance of incorporating sustainability criteria

Description	0	1	2	3
Embedded the sustainable concepts in the subjects	0	46,15	42,31	11,54
Show recent real cases	0	7,69	23,08	69,23
Develop projects.	3,85	3,85	30,77	61,54

From the analysis of the result we can determine that a very appropriate way to introduce sustainability in the curriculum is through studying real cases, 69.23% gives the maximum score, although 61.54% also consider that they can be introduced with the development of projects. On the other hand, there is an 11.54% which would give the highest score to the introduction of concepts

Table 7 Proposal of distribution the sustainability criteria in the curriculum.

Description	1 st -2 nd	3 ^o -4 ^o	TFG	GRADE	GRADE +TFG	MASTER	TFM	MASTER +TFM	GRADE + MASTER
Embedded the sustainable concepts in the subjects	46,15	30,77	0	11,54	0	7,69	0	0	3,85
Show recent real cases,	0	42,31	3,85	0	11,54	23,08	0	7,69	11,54
Develop projects.	0	15,38	15,38	3,85	7,69	15,38	0	15,38	26,92

On the question of when we can realize that the introduction of concepts would be done in grade with preference in the 1st and 2nd year. The real case studies would be done preferably in the 3th and 4th. There isn't this consensus in considering when the development of projects should be introduced, the majority option is to be distributed in grade and master (26.92%). It should be noted that a (42.3%) believed that they can be done only in the grade and a (30.76%) prefer in the master.

4 How is applied in the Engineering curriculum.

4.1 Project P-15 Environmental Sustainability IQS of 2017-2020 Strategic Plan

The 4.1 Project P-15 Environmental Sustainability IQS of 2017-2020 Strategic Plan objectives are to consolidate the contribution and the presence of environmental sustainability in teaching, research and dissemination activities and to apply good practices to achieve a sustainable campus.

As sub-objectives related to the incorporation of sustainability in the training of the engineer it is proposed to promote cross-disciplinary sustainability content among various studies and engineering projects (TFG/TFM) to design a more sustainable Campus.

4.2 The ABET Program accreditation

Under the seven points for student outcomes listed in the Accreditation Board for Engineering and Technology criteria for accrediting engineering programs in the 2019-2020 accreditation cycle, two criteria strongly related to sustainability and sustainable development can be found. (ABET 2019) Unfortunately,

the teaching of the sustainable development skills defined for outcome 2 can be particularly difficult for engineering faculty who must balance this against the need for increasing technical curriculum content. So, had been considered only ABET Outcome 4 in the distribution of the sustainability criteria in the curriculum. (Thürer et al. 2018)

Table 8. Graduates of Industrial Engineering MS program acquire the knowledge and develop the skills shown below:

OUTCOME	Description
1	They can identify, formulate and solve complex Industrial Engineering problems by applying principles of engineering, science, and mathematics.
2	They can apply engineering design to produce solutions that meet specified needs with consideration of public health, safety, and welfare, as well as global, cultural, social, environmental, and economic factors.
3	They can communicate effectively with a range of audiences, both orally and in writing.
4	They recognize ethical and professional responsibilities in engineering situations and make informed judgments, which must consider the impact of Industrial Engineering solutions in global, economic, environmental, and societal contexts.
5	They can function effectively on teams whose members together provide leadership, create a collaborative and inclusive environment, establish goals, plan tasks, and meet objectives.
6	They can develop and conduct appropriate experimentation, analyze and interpret data, and use engineering judgment to draw conclusions.
7	They understand the need for life-long learning, acquire and apply new knowledge as needed, using appropriate learning strategies.

Table 9. Distribution the sustainability criteria in the curriculum of the Bachelor and Master's degree program in Industrial Engineering at IQS School of engineering

ECTS -ABET OUTCOME	1 st -2 nd	3 th -4 th	TFG	GRADE	GRADE +TFG	MASTER	TFM	MASTER +TFM	GRADE + MASTER
ECTS	120	108	12	228	240	90	30	120	360
ECTS ABET- 4	16,5	37,5	12	54	66	31,5	30	60,5	104,5
ECTS ABET- 4 (%)	12,75%	34,72%	100%	23,68%	27,50%	35%	100%	50,41%	29,03%

Table 9 detailed the distribution of ECTS in the curriculum of the Bachelor and Master's degree and the number of ECTS of the subjects that had incorporate de ABET Outcome 4. The analysis showed that the percentages of credits enhanced by sustainable development do not follow the proposal obtained from the survey. Embedded the sustainable concepts in the subjects in the first two years was considered important and only 12.75% incorporated them. It is also low the percentage of credits related to sustainable development in the 3rd and 4th year.

Although the Finals Projects (TFG and TFM) consider the ABET 4 Outcome, the final percentage of sustainability related credits is only 29.03% of the total 360 credits.

5 Conclusions

The engineer should be able to apply engineering design to produce solutions that meet specified needs with consideration of public health, safety, and welfare, as well as global, cultural, social, environmental, and economic factors. (ABET, 2019) The 2030 agenda for sustainable development and the Sustainable

Development Goals (SDGs). (United Nations,2015) propose concrete actions that integrate multiple aspects with effective communicative strategies.

The survey has validated the opinion that the learning activities in the two first years would aim to understand the natural and social system present in our society, how humans have modified those systems and understand the role of technology based on models of successful experiences it is considered a priority for first contact right at the start of training to promote a particular way of thinking that incorporates a new aspect to the design of production process. (Kamp, L 2006)

As obtained from the survey, the competencies that allow technical projects to be carried out creatively, ethically and with critical thinking considering impacts, risks and social and the environment should be emphasized. These competences should be developed with active learning styles, using recent real cases and projects.

5 References

AQU CATALUNYA. 2014. Universitat i treball a Catalunya 2014. Barcelona: Agència per a la Qualitat del Sistema Universitari de Catalunya.

ABET 2019 <https://www.abet.org/wp-content/uploads/2018/11/E001-19-20-EAC-Criteria-11-24-18.pdf>

Graaff, E. D., & Ravesteijn, W. 2001. Training complete engineers: Global enterprise and engineering education. *European Journal of Engineering Education*, 26(4), 419-427.

Kamp, L. 2006. Engineering education in sustainable development at Delft University of Technology. *Journal of Cleaner Production*, 14(9-11), 928-931.

Leal Filho, Walter, Constantina Skanavis, Aristeia Kounani, Luciana Londero Brandli, C. Shiel, Arminda do Paço, Paul Pace, et al. 2019. "The Role of Planning in Implementing Sustainable Development in a Higher Education Context." *Journal of Cleaner Production* 235: 678–87.

Segalàs, J., D. Ferrer-Balas, and K. F. Mulder. 2008. "Conceptual Maps: Measuring Learning Processes of Engineering Students Concerning Sustainable Development." *European Journal of Engineering Education* 33 (3): 297–306.

Thürer, Matthias, Ivan Tomašević, Mark Stevenson, Ting Qu, and Don Huisinigh. 2018. "A Systematic Review of the Literature on Integrating Sustainability into Engineering Curricula." *Journal of Cleaner Production*. Elsevier Ltd.

United Nations (2015). Transforming our world: The 2030 agenda for sustainable development. A/RES/70/1

Wals, A. E. J. 2014. Sustainability in higher education in the context of the un DESD: A review of learning and institutionalization processes. *Journal of Cleaner Production*, 62, 8-15.

Case studies in professional-oriented education: engaging with sustainability and complexity

Kristen MacAskill¹, Catherine Tilley²

¹Department of Engineering, University of Cambridge, United Kingdom

kam71@cam.ac.uk

²King's Business School, King's College London, United Kingdom

Abstract

Case studies have been used in management teaching for nearly a century, and have deeper roots in the teaching of other professions, including law and medicine. Cases have considerable value as a teaching method but there has been increasing criticism of the limitations of many of the case studies currently available. There are challenges that are particularly relevant to today's professional students who are often working at the complex interface between technical and social issues. First, many cases have a clear disciplinary label and do not embrace multi-disciplinarity. Second, most cases are focused on organising and analysing issues and arrive at a decision, usually placing primacy on the outcomes for a single company, and do not capture the complexity created by social and environmental considerations. This is problematic when it comes to considering how to address issues associated with sustainability and resilience in the built environment. This paper reports on a revised, piloted case study model that addresses the shortcomings of existing typical cases, focusing on exploring problems rather than making specific decisions. The pilot case, on engineering decisions in disaster recovery, was based on insights developed through a research project. Similar to other case teaching, the lecturer becomes a facilitator to help participants through the case, rather than specifically teach material. This proved to be a successful way of exploring a complex problem space where there is no right answer, only lessons that can be drawn from the tensions presented. Drawing on this experience, this paper outlines what this means for the roles of teachers and post-graduate training in advancing professional-oriented education in engineering and the built environment.

1 Introduction

One of the challenges of engineering education for sustainable development (EESD) is that students need to look beyond technical problems to the broader social and environmental context of professional engineering decisions. As technology improves to automate more technical problem-solving, the role of engineering professionals is evolving to involve deeper levels of stakeholder engagement. Practitioners find themselves dealing with intractable problems of working with groups who have very different perspectives on the needs for sustainable communities and resilient infrastructure. However, there is a noticeable shortage of teaching materials suitable for students to engage in this type of problem solving. While case studies show considerable potential as a way of exploring unstructured, complex problems, there is not an established library of materials designed for engineering students. In this paper, we address this gap by first

examining the way case studies can be used in EESD, and then showing an example developed from our own research and teaching practice.

In responding to the University of Cambridge's mission to contribute to society through the pursuit of education, learning and research, an opportunity was identified to bring relevant research to life through a revised case study teaching format. Our initial focus is on creating case studies that are suitable for teaching experienced professionals. This is partly because of the increased emphasis on life-long learning. It is also partly because these people are in the 'front line' of the fulfilment of the Sustainable Development Goals, and other related elements of the United Nations agenda such as the Sendai Framework for Action (on disaster risk reduction). The basis for this approach emerged from two observations made in our understanding of teaching experienced engineering professionals. Firstly, setting journal papers as pre-reading only goes some-way towards engaging students with learning material – where they may come ready to class to engage in the concepts, rather than just be introduced to them in class. Secondly, case studies take theory and turns it into more of a narrative that *require* student participation in class. Cases are structured specifically with the lesson in mind. However, case study teaching is not typically applied to the engineering profession, so coverage of issues encountered by engineering professionals (beyond those encountered generally when running a business) in existing cases are limited.

To address this gap, we present how we developed an approach to developing case studies for EESD for experienced professionals. In this paper we look at coverage of “natural disasters” as a focused topic within the wider scope of sustainable development concerns. This is primarily due to circumstances that presented an opportunity to create and trial a case study based on a research project on post-disaster reconstruction. However, we believe that the essential principles of building for resilience to natural disasters are applicable in other sustainability-related contexts, and that the case allows students to develop problem-solving skills to manage other complex, multi-stakeholder situations.

This paper is organised as follows. First, we introduce the key features of case study teaching. Then, we critically review the existing case studies on natural disasters, and demonstrate the gap in the teaching materials that we sought to address. The paper then introduces the approach we took to developing, piloting and teaching the case study, before concluding with some observations about the implications of this work for research and practice.

2 A brief review of case study teaching

Cases have been used in management teaching for nearly a century, and have deeper roots in the teaching of other professions. Rippin et al. (2002) provide a helpful history of the development of case study teaching in management training, highlighting the earlier roots in law and medicine. Harvard Business School (HBS) academics were pioneers of the method at the start of the twentieth century; HBS still dominates the market for business school case studies. HBS define the method briefly as “a discussion of real-life situations that business executives have faced”. The intent is to develop "wisdom" among participants in a shorter period than they might achieve through their own professional experience. Freeman Herreid (2011) reviews the case study teaching method in its variety of forms. Essentially, his paper summarises the different ways to engage with the case method, from a didactic approach where the teacher acts as a storyteller (similar to the traditional lecture method) through to small group discussions where students teach each other (the approach more commonly adopted via the HBS method). Drawing on established teaching theory Freeman

Herreid emphasises that increasing the levels of discussion with students, and between students, increases level of retention of information.

The case study essentially presents a summarised real experience. It allows students to engage with content based on real situations, without providing a “right” answer. Cases material may be formed via mixed media, although historically have been in written form, 1 to 50 pages in length. *The case study handbook* (Ellet, 2018) advises that a case must have four characteristics:

1. A significant business issue or issues (to provide the basis for learning).
2. Sufficient information on which to base conclusions about the issues (to allow engagement and debate of the issue presented, based on evidence).
3. No objective conclusion, in other words: no explicit or implied right answer (real life involves different opinions and perspectives).
4. Organised in a nonlinear way (evidence is not always presented neatly, students need to apply their own critical thinking and extract relevant information).

Interpretation of point 1 above is expanding. Rippin et al. (2002) observed that there is a change in application of the traditional case method to use it as a means to explore complexity and ambiguity. By "traditional approach" they are referring to what they have termed a *mode 1* case, which places emphasis on problem-solving and decision-making. This is in contrast to *mode 2* cases, which focus on developing critical thinking skills to manage ambiguity and complexity. They suggest that *mode 1* has been the dominant basis for decades of case study teaching in management, but with *mode 2* emerging as a concept in the 21st Century. There are other supporters of *mode 2*. While Akrivou and Bradbury-Huang (2015) do not directly adopt the *mode 1/mode 2* terminology, their paper implicitly supports the need for greater emphasis on *mode 2* teaching. They call for business schools to be "custodians of society", teaching people to serve long-term prosperity of humanity, rather than serving the interests of specific organisations.

Experts in EESD have long called for the need to place greater emphasis on the wider context of technical engineering decisions (see, for example Fenner et al., 2006; Allenby et al., 2009; Byrne and Mullally, 2014; Mulder, 2017). However, specific teaching resources remain somewhat limited. Given the desire to develop engineering professionals to engage with complexity and to recognise the wider social impacts of their decisions, *mode 2* case study teaching presents as a potentially useful approach. We therefore decided to review existing HBS case studies on “natural disasters” – a topic which has clear relevance for EESD to assess whether suitable materials for postgraduate EESD would be available.

3 Reviewing the current state of case studies

To demonstrate the observed gap and opportunity in case study teaching, we present a brief review of a sub-set of cases available through the current Harvard Business Publishing catalogue (<https://hbsp.harvard.edu/>). A key word search of “natural disasters” returns 41 cases (with a further 16 supporting cases). Sixteen of the main cases are published via the Harvard Business School, eight through the Harvard Kennedy School and others across a number of management/business schools. This is a small sub-set of hundreds of cases in this catalogue, but demonstrative in reinforcing key points made in the above review of case study teaching.

Within the 41 case set, the database indicates predominant key topics of general management (31 cases), corporate social responsibility (20 cases), business and government relations (15 cases) and operations and processes (14 cases). Unsurprisingly, given the emphasis of business school teaching, these cases are either oriented on an issue for a specific business, or a broader focus on the operation of markets. Where the case is oriented on a specific company, the subject focus predominantly covers supply chain management and various forms of business strategy. This small set of cases helps to reinforce two critical points:

(A) *Mode 1* cases dominate the list, where there is a traditional business school focus on decisions made in business that have the potential to have a critical impact on business performance.

(B) Where focus is expanding in these cases, for example in exploring themes oriented on social issues, sustainability and ethics, the case remains generally focused on the continuity of business.

The disasters referenced in these cases include, among others, Hurricane Katrina (from 2005), the 2010 Haiti Earthquake and the Great East Japan Earthquake of 2011. These all hit global headlines given the significant physical and social impacts of these events. However, these existing cases are typically focused rather narrowly on business and finance. Only one case considers an infrastructure design-related issue. The Harvard Kennedy School cases tend to be broader in focus, exploring a wider governance and government relations issues. The examples presented in Table 1 represent two of the few cases that have a clear connection to infrastructure in the significant issue at the core of the case. The discipline area and key words are those supplied with the cases.

Table 1: Example cases covering a “natural disaster” theme

Source	Harvard Business School	Harvard Kennedy School
Title	The Big Easy, Not So Easy	Rebuilding Aceh: Indonesia's BRR spearheads post-tsunami recovery
Discipline	Finance	Business & government relations
Subject key words	Emerging markets, Cross functional management, Project management, Risk management, Community development, Natural disasters, Reputations, Risk mitigation	International Development, Disaster recovery, Natural disasters
Industry key words	Real estate, rental & leasing, Residential construction	Not provided
Case summary	Oriented on the rebuilding housing projects in New Orleans following Hurricane Katrina. The case explores the environmental, contractual, reputational, and legal risks in rebuilding, and whether the group at the core of the case, Enterprise Community Partners, is to lead the rebuilding, what changes might be involved.	This case focuses on how the recovery agency (known as BRR) in Indonesia coordinated reconstruction efforts following the 2004 tsunami. It explores the challenges of setting up the agency and coordination of the recovery process, covering thousands of reconstruction projects.

There are challenges that are particularly relevant to today's professional students who are often working at the complex interface between technical and social issues. First, many cases have a clear disciplinary label and do not embrace multi-disciplinarity. Second, most cases are focused on organising and analysing issues and arrive at a decision, usually placing primacy on the economic outcomes for a single company. That is, they often do not capture the complexity created by social and environmental considerations, particularly in the context of engineering and infrastructure. While cases are broadening out to explore issues such as climate change, our observations are that "business" remains the centre of the narrative.¹ We therefore set out to create and teach a new case study that would address these concerns directly.

4 Developing a case study for EESD teaching

Our approach had three phases. First, we set some criteria for case development, building on our analysis of EESD requirements, and identified a body of research that we could use for creating the case. Then, we prepared the case materials and pedagogical design. Finally, we ran a pilot teaching session so that we could ensure that the materials met our teaching aims before we introduced the case to the curriculum.

Step 1: Setting the teaching goals and identifying the research

Our aim was to help students engage with a complex system of actors and how the tensions between different people or concepts can shape behaviour – sometimes resulting in unintended outcomes. To do this, we set about creating a case study on the post-earthquake recovery of the city of Christchurch, New Zealand, as a trial for the revised case study concept, expanding the framing of the problem that a case addresses. The Christchurch context was chosen as a starting point to allow us to draw on material from a research project that had previously been led by one of the authors of this paper. The existing material (a PhD and associated published papers) informed a two-part case study, which is described below.² The objective of this pair of associated cases is about how people respond in a complex situation that cannot be anticipated in detail. It features the problems of operating in a multi-stakeholder landscape under pressure of time and cost, where the engineers have to respond to a range of pressures. The narrative is based around the role of SCIRT, an engineering and construction alliance that was convened to rebuild the city's roads, water, sewerage and land drainage systems.

Step 2: Developing the case design

The process of converting this material to teaching material involved four key steps. First, we needed to clarify our learning objectives. While our aim was a large one, we needed to clarify the specific goals of the teaching session and design materials that would deliver these. Second, we needed to reduce the very extensive research material to a much shorter format. This involved simplifying the context and narrative of the existing material, and emphasising the points that could support discussion focused on the learning objectives. With the core material developed, we then developed the lesson structure (step three) and a

¹ As demonstrated in this short video from HBS, published in Sept 2019 (https://www.hbs.edu/about/video.aspx?v=1_h3k7ye6p).

² For example background material see (MacAskill and Guthrie, 2015, 2017, 2018; MacAskill, 2019). The case study itself is not currently publicly available - please contact the authors directly.

teaching note (step four) to guide the instructors through the session, recognising that the focus for the teachers would be on facilitating discussion rather than presenting information.

The case is designed in two parts, set in the aftermath of the series of earthquakes that affected Christchurch in 2010/11. Case A is the main case and can be delivered as a stand-alone case. It describes the problems of ‘building back better’ in Christchurch. While the infrastructure rebuild programme was initiated with good intentions to improve resilience in the city’s infrastructure, there were a series of problems that inhibited this. The case allows the students to explore the way that tensions between the different stakeholders created a difficult environment requiring design compromises. This case helps students develop the following skills:

- Defining and scoping a complex problem
- Stakeholder identification and management
- Understanding the way organisations may improvise in order to respond to changing conditions
- Challenges of building back better and design for resilience
- Explore the role of engineers in shaping cities, within the wider context of other actors

Part B is a supporting case, focusing more specifically on an issue that emerged during the recovery. Specifically, this explores the design choices made by engineers in a part of the infrastructure system that – while technically sound – proved controversial with the community they served. It is intended to help students with the following skills:

- Understanding the critical relationship between technical and social problems and solutions
- Developing stakeholder engagement strategies
- Identifying and addressing the trade-offs involved in design decisions in difficult conditions

In order to test the teaching materials (including our lesson plan), we held a pilot session before introducing this case to the curriculum.

Step 3: Pilot and delivery

We held a pilot trial with post-graduate engineering students (master’s and PhD level) and staff (research associates and course leaders) at the University of Cambridge. There were twelve participants. The participants were required to read Part A before the session, and were given time to read Part B part-way through the session. The session lasted three hours in total. While some traditional lecture slides were used to reinforce key theories engaged with, the session emphasised group discussion.

Every participant provided feedback at the end of this session. Helpful pointers were provided regarding the structure of the session, which were mostly related to the newness of the case and experimentation of the lecturers as to how to best engage with the students with the material.

The respondents were unanimous that they thought the case study was effective, and that by exploring the case first and then applying theory they learned more. The students were a diverse group, and although they were almost all engineers, they came from different disciplines and brought different perspectives to the session. The basic rhythm (do something new every 20 minutes or so) and variety was effective. The students particularly appreciated the activity when they broke into different stakeholder groups, because this actively promotes a greater level of engagement (which was generally very good). People were also

interested in the ‘end’ of the story, seeking an update on how Christchurch is recovering after the earthquake. This would help make sure that people feel that the session is concluded. Although, in adding such content we suggest care must be taken to emphasize that this does not necessarily present the “right” solution, merely the one that ultimately emerged from the tensions presented in the case. This positive and constructive feedback led us to make some small changes to the teaching delivery (for example, including more photographs to help the students to ‘situate’ themselves in the case), and the case study has now been incorporated into our teaching practice.

5 Conclusion

This paper makes the following contributions. First, it shows the potential for developing case studies as a teaching method for helping students explore complex problems. Second, it outlines the shortcomings of the current canon of case studies on exploring engineering-oriented problems and in enabling students to take a broad and holistic view of problems. Third, it illustrates an approach to developing new cases as a way to introduce students to the more complex, multi-faceted problems that are involved in building communities.

The work has implications for further research and for practice. The case described in this paper was developed using the material from a large-scale research project as its starting point. There is considerable potential to use certain types of research project – for example, those involving research with multiple stakeholder groups – as a basis for case development. By doing this, it is possible to increase the potential impact of the research. One implication for researchers is that they could bear this possible application in mind as they design their research programmes. The case study approach also has implications for teaching: the role of the teacher in this method is more facilitative than instructional, and this makes new demands on teaching staff. Despite these challenges, research-led cases show great potential for advancing professional-oriented education and preparing engineers and professionals in the built environment for the challenges of building sustainable and resilient communities.

We see a real opportunity for engineering education to advance with this model – exploring the context of decision making that ultimately shapes the boundaries of the project within which technical engineering decisions are made. While technical-oriented decisions (such as sizing of components such as pipes) can have sustainability implications, the wider political and institutional context often has a substantive influence in shaping sustainability considerations. Engineers will need to be able to understand and navigate these complex contexts in order to create resilient and flourishing communities.

Acknowledgement

The development and pilot of the case study was made possible with the support of the Laing O’Rourke Centre for Construction Engineering and Technology, Department of Engineering, University of Cambridge.

References

- Akrivou, K. and Bradbury-Huang, H., 2015. Educating integrated catalysts: Transforming business schools toward ethics and sustainability. *Academy of Management, Learning and Education*, 14(2), pp.222–240.
- Allenby, B., Murphy, C.F., Allen, D. and Davidson, C., 2009. Sustainable engineering education in the United States. *Sustainability Science*, 4(1), pp.7–15.
- Byrne, E.P. and Mullally, G., 2014. Educating engineers to embrace complexity and context. *Proceedings of the Institution of Civil Engineers - Engineering Sustainability*, 167(6), pp.241–248.
- Ellet, W., 2018. What is a case? In: *The case study handbook: A student's guide*. Boston: Harvard Business Publishing.
- Fenner, R., Ainger, C., Cruickshank, H. and Guthrie, P., 2006. Widening engineering horizons: addressing the complexity of sustainable development. *Proceedings of the Institution of Civil Engineers - Engineering Sustainability*, 159(4), pp.145–154.
- Herreid, C.F., 2011. Case study teaching. *New Directions for Teaching and Learning*, 128, pp.31–40.
- MacAskill, K., 2019. Public interest and participation in planning and infrastructure decisions for disaster risk management. *International Journal of Disaster Risk Reduction*, 39(April), pp.1–9.
- MacAskill, K. and Guthrie, P., 2015. A hierarchy of measures for infrastructure resilience – learning from post-disaster reconstruction in Christchurch, New Zealand. *Civil Engineering and Environmental Systems*, 32(1–2), pp.130–142.
- MacAskill, K. and Guthrie, P., 2017. Organisational complexity in infrastructure reconstruction – A case study of recovering land drainage functions in Christchurch. *International Journal of Project Management*, 35(5).
- MacAskill, K. and Guthrie, P., 2018. Funding mechanisms for disaster recovery: Can we afford to build back better? *Procedia Engineering*, 212(451–458).
- Mulder, K.F., 2017. Strategic competences for concrete action towards sustainability: An oxymoron? Engineering education for a sustainable future. *Renewable and Sustainable Energy Reviews*, 68(2017), pp.1106–1111.
- Rippin, A., Booth, C., Bowie, S. and Jordan, J., 2002. A complex case: Using the case study method to explore uncertainty and ambiguity in undergraduate business education. *Teaching in Higher Education*, 7(4), pp.429–441.

Integrating ethics across the curriculum through sustainability topics

Diana Adela Martin¹, Eddie Conlon¹ and Brian Bowe²

¹School of Multidisciplinary Technologies, Technological University Dublin, Republic of Ireland

dianaadela.martin@tudublin.ie

²Office of Quality Assurance and Academic Programme Records, Technological University Dublin, Republic of Ireland

Abstract

The paper explores the coverage of sustainability in Engineering programmes in Ireland in the context of increasing calls for integrating ethics across the curriculum. It is part of a broader study examining engineering ethics education conducted in cooperation with the national accrediting body, Engineers Ireland, including 23 Engineering programmes from 6 institutions. We begin by describing the current empirical research about the implementation of ethics education across the curriculum, which is predominantly US based, before moving to the presentation of the research methods employed in our study. We then focus on two major findings of our study. First, we examine the views about the implementation of ethics expressed by evaluators appointed to accreditation panels of Engineering programmes. Building on the preference expressed by evaluators for integrating ethics across the Engineering curriculum and on some of the challenges highlighted by them as well as by existing research, we proceed by examining the implementation of Engineering ethics education through sustainability related coverage. We argue that sustainability related coverage might be a good candidate for integrating ethics across the curriculum, concluding with insights and examples that can serve as guidance in the implementation of ethics.

Introduction

Recent years have witnessed a greater call for integrating ethics across the Engineering curriculum, in modules with both a technical and non-technical orientation (Cruz and Frey 2003; Newberry 2004; Drake *et al* 2005; Ocone 2013). There are several advantages mentioned in connection to teaching and assessing ethics in several modules throughout an Engineering programme, such as providing a holistic and interdisciplinary approach that “mirrors the ways in which ethical issues arise in day-to-day engineering practice” (Cruz and Frey 2003, p. 545), thus allowing students “to see ethics in action” Ocone (2013 p. e114). The integration of ethics across the curriculum also helps students become aware of the intrinsic connection between ethical concerns and technical content, by rectifying the preconception that ethics is just an “add-on material” (Newberry 2004, p.346). As such, this approach is considered to be more effective in improving engineering students’ moral reasoning and sensitivity to ethical issues than solely having dedicated modules on ethics (Drake *et al* 2005, p. 223). Nevertheless, there are also significant challenges reported about the method of implementing ethics across the Engineering curriculum. The most significant challenges relate to the background of Engineering

lecturers and their lack of familiarity with societal and ethical related topics (Newberry 2004), but also students' reticent attitude towards ethics (Bielby *et al* 2011).

Our paper examines the integration of ethics across the curriculum in Engineering programmes in Ireland through the prism of sustainability related coverage. Sustainability falls under one of the seven criteria listed by Engineers Ireland (2007) that Engineering programmes have to demonstrate for accreditation. Programme outcome E dedicated to ethics requires graduates to show “knowledge and understanding of the social, environmental, ethical, economic, financial, institutional, sustainability and commercial considerations affecting the exercise of their engineering discipline”, as well as “knowledge ... of engineering practice, and the impact of engineering solutions in a societal and environmental context” and “commitment to the framework of relevant legal requirements governing engineering activities, including environmental” Further, some have argued that a focus on sustainability may provide a focus for broadening engineering ethics beyond a micro ethical approach (Conlon and Zandvoort 2011; Byrne 2012).

Our contribution is based on a study supported by the national accrediting body in which 23 Engineering programmes from 6 higher education institutions in Ireland participated. Our research employed document analysis of module descriptors and interviews with lecturers and evaluators. Based on the modules deemed by the participant programmes to have the strongest contribution to meeting outcome E for the purpose of accreditation, our study points to sustainability as the topic most employed in the teaching of Engineering ethics in Ireland.. Our findings suggest that sustainability is the topic falling under outcome E that is most present across the curriculum of the participant Engineering programmes in Ireland.

In light of these findings, we aim to address the need for guidance on implementing ethics across the Engineering curriculum (Byrne *et al*, 2012; Mesa 2017), by presenting some examples on how sustainability related content has been put in practice in the participant programmes, which can be adapted within other programmes.

2 Research Methods

In order to determine the implementation of ethics in Engineering programmes in Ireland, two research methods have been employed: (a) document analysis of the documentation which was either prepared by the programmes for accreditation or is available online on the website of all participant programmes and (b) interviews with lecturers from the participant programmes teaching a professional formation module and evaluators who served in the accreditation panel during the events observed. The two methods are seen as complementing each other in order to develop a comprehensive insight into the implementation of ethics education in the participant programmes.

The scope of the study was limited to Engineering programmes that underwent accreditation between 2017-2019. Twenty three programmes offered by 6 institutions are included. Our present analysis focused on the modules that the programmes themselves have deemed to have the highest contribution to meeting programme outcome E. To identify these modules, we relied on a mandatory rubric in the documentation submitted by the programmes for accreditation, in which the programmes self-assess how they meet each of the seven programme outcome. Thus, the modules that were assessed by the

participant programmes with the highest contribution to outcome E were singled out for a documentary analysis of the topics and learning outcomes employed in connection to ethics instruction.

The documentary analysis relied on two main data sources: a rubric present in the documentation submitted by the participant programmes for accreditation, by which the programmes describe how they meet programme outcome E, and the module descriptors provided either as an annex to the documentation submitted for accreditation (6 programmes) or part of the evidence presented during the accreditation events observed (11 programmes) or posted online on the programmes' website (6 programmes). At the end of this stage, there was a total of 83 unique modules with a strong contribution to meeting programme outcome E. The next research stage was dedicated to analysing the content inputted in the previous stage, following two iteration stages. First, a codebook was generated with 28 initial codes covering curricular content purporting to ethics informed by the standard description of topics falling under outcome E (Engineers Ireland, 2007) and the literature about the content of engineering ethics education. It was followed by a second iteration stage, which grouped the initial thematic codes under broader categories.

Having established the major themes employed to teach ethics in the participant programmes, we sought to get a more in-depth exploration of the topics and methods used to teach ethics. This was achieved through a series of interviews. Sixteen lecturers of professional formation modules were questioned about the topics and methods employed in teaching ethics. Six evaluators who served on the panels of Engineers Ireland during the accreditation events of 3 institutions observed by the researcher, were also interviewed. The evaluators were questioned about their views on engineering ethics education and its implementation in the evaluated programmes.

3 Implementing Engineering ethics education across the curriculum: the evaluators' perspective

All six evaluators interviewed for the study showed a preference for seeing ethics integrated across the curriculum rather than in dedicated modules. This approach is considered to foster the development of holistic engineering graduates that do not divorce ethics from the technical solutions they pursue. As one evaluator claims, "that's the way it has to go if we want to produce engineers that consider ethics as part of their direct logical reasoning." Another evaluator argues that "it has to be across, we don't just want to see it in the professional development modules, you'd like to see some mention of it elsewhere in the other modules as well. [...] You can't just be ethical in one module, there should be an element of it everywhere." This opinion is shared by a third evaluator who considers that "ethics possibly should be brought into more modules as opposed to just being covered in a module". The reasoning behind this preference is that having ethics addressed in a dedicated module could contribute to the perception of the topic as an add-on, "just to get it in the course", and thus minimizing its importance in the Engineering curriculum.

Based on the interviews conducted, there is a sense that technical and ethical issues need to be "combined and fused in real life situations." Nevertheless, evaluators consider that Engineering programmes in Ireland are not yet at the stage of implementing ethics across the curriculum. "It's not

quite there yet. I don't see any programmes where it is permeating throughout”, states one evaluator, while another evaluator agrees that “most modules do not cover ethics. In any module that has a high technical content, probably ethics is not covered there.”

A challenging aspect according to one of the evaluators is that “for some modules it's going to be hard to bring it into light”. This point is expanded by another of the evaluators questioned. According to him, “it's very difficult because of the way the existing crop of academics were taught engineering was in a very different way to the way we're teaching engineering now”, which leads to a “slow process of getting people to think more holistically in their approach to engineering education”. There is an agreement among the evaluators for the need for more guidance on how to implement ethics more effectively, especially in the case of technical modules.

4 Sustainability in Engineering ethics education

When analyzing how ethics is being integrated in the curricula of the participant Engineering programme from 6 HEIs in Ireland, we found that sustainability is the most popular theme employed in connection with meeting programme outcome E for accreditation. Table 1 shows that 49 (59%) modules deemed to have a high contribution to outcome E incorporate sustainability related topics. The topics mentioned in connection to the teaching and assessment of the theme of sustainability are the principles of sustainable development, environmental impact and protection, climate change, carbon management, energy efficiency, renewable energy, life cycle analysis, waste management, sustainable economic growth and eliminating poverty traps. There is a higher emphasis on the environmental dimension of sustainability than on its social and economic dimension.

Table 1: The distribution of sustainability related coverage across module types (n=83 unique modules)

Technical Modules (n=36)	Design modules (n=15)	Professional formation modules (n=12)	Capstone Projects (n=8)	Work Placement (n=2)	Business studies modules (n=6)	Legal studies modules (n=3)	TOTAL (n= 83)	%
19	10	8	5	1	4	2	49	59%

The theme of sustainability is covered in a wide variety of module types, such as technical modules, design modules, professional formation modules, capstone projects, work placement programmes, business studies modules as well as legal studies modules. An exception, considered insignificant is for the only module categorized as a personal development module, which does not offer coverage related to sustainability. More so, as seen in Table 1, sustainability related coverage is present in more than half of the modules with a strong contribution to outcome E from each module type. This suggests that sustainability might be a good candidate for integrating ethics across the curriculum.

From the perspective of lecturers, sustainability has the advantage of being a theme that suits the technical expertise of Engineering faculty members. As one lecturer states, sustainability coverage has “the potential” to be integrated in technical modules. According to her, ethical questions about energy efficiency and waste production “did resonate because people could see how they might be involved in something that could be problematic”. Sustainability is also found to be appealing to students, who were found to show “a real interest.” Reflecting on her classroom experience, one lecturer noticed a real focus on the Sustainable Development Goals, with students commenting that “this was something they really enjoyed”.

These observations seem to address two common challenges highlighted by current research on Engineering ethics instruction. One such challenge is the Engineering faculty' lack of familiarity with the topic, which that hinders the linkage of ethical concerns with technical subject matters (Sinha *et al*, 2007; Harding *et al*, 2009; Walczak *et al*, 2010; Romkey, 2015; Monteiro, 2016; Polmear et al, 2018). A second challenge is the students' negative reception and engagement with nontechnical content (Harding *et al*, 2009; Romkey, 2015; Polmear et al 2018).

5. Sustainability across the curriculum in practice

Sustainability is present in the curricula of the participant programmes both in taught components and assessments. In what follows, we describe some of the evidence of sustainability coverage in both these components. Table 2 shows that the participating programmes incorporate sustainability topics through various taught components, such as lectures, case studies, community service, online polling systems and documentaries.

Table 2 Teaching methods incorporating sustainability issues

Type	Example of content
Lectures	Principles of sustainable development The relationship between a country's CDP and associated energy use Wealth inequality Local and/or international environmental policies Environmental ethics in different traditions of thought
Case studies	Ethical dilemmas about waste water treatment technologies
Community service	Developing environmentally-friendly and/or socially-conscious building retrofits based on needs identified through direct interaction with a non-profit entity
Online polling systems	Asking students to input the moral decisions they made in their lives for tackling climate change
Films and documentaries	Watch a documentary on progress from a critical perspective, looking at the interlink between ecological environmental, social and economic aspects of sustainability

Some examples of topics introduced in lectures are the principles of sustainable development, environmental policies and standards, environmental and ecological theories representative of the Western, Buddhist and Native American traditions and the role of engineering in addressing wealth inequality. The topics included through lectures show a concern with both the environmental and socio economic dimension of sustainability.

The case studies used by the lecturers interviewed aim to foster students' reflection on the implications of developing technologies that fail to meet environmental standards. For example, a case study about wastewater treatment explores the "certainty of knowing" that the discharge from the respective technology is "actually polluting the environment or was it just that we took one sample and that sample is inaccurate?" Students are exposed to the various type of ethical concerns that arise, such as "the rigor and integrity of their data collection and management, the cost benefit of different solutions, and the impact of one solution over another solution."

We see that the integration of several various teaching approaches leads to a more holistic approach to the topic of sustainability, which incorporates its three pillars of environmental protection, economic viability and social equity. This seems to suggest that a hybrid approach to the incorporation of sustainability in the Engineering curricula is needed in order to offer students a more rounded understanding of the topic

In order for the integration of ethics across the curriculum to be successful, it was argued that the inclusion of ethics in taught components is insufficient by itself if it is not accompanied by an assessment of the ethical components of technical modules (Bairaktarova and Woodcock 2017, p. 1132). In what follows, we present several examples of the integration of sustainability aspects in the assessment methods employed by the participant programmes. As seen in Table 3, sustainability was found to be included in exam question, reports, presentations, research projects, design projects and capstone projects.

Table 3 Assessment methods incorporating sustainability issues

Type	Example of content
Exam questions	discussing the ethics of landfilling
Research projects (incorporating reports, posters and presentations)	about the sustainable development goals about the state of energy legislation in Ireland and the EU,
Design projects	Projects that incorporate the design for environment approach
Capstone project	Mandatory rubric discussing the ethical implications and issues arising in the final year project

One of the lecturers interviewed gave the example of an exam question they introduced, which asked students to discuss the ethics around landfilling, and “whether it is a problem or an opportunity, whether you can generate energy and actually recover things from it and turn it into a positive, or whether the negatives do outweigh that”.

Research projects are a popular method of incorporating sustainability topics in assessment. Some of the examples mentioned by the lectures interviewed revolve around asking students to present or write a report on the sustainable development goals. A lecturer described how their report assignment is asking students “to put the context of why the chosen goal was a challenge, and then to discuss what progress had been made so far and to critique that, whether that was sufficient progress, whether they were on a good trajectory, and then what environmental engineers could do in the next decade in order to be able to meet that 2030 target”. Another example of a research project asks students to analyse energy policies across a number of countries, with a focus on their impact of the adoption of bio-energy technologies “that could lead to sustainable, cyclic energy systems”.

The majority of capstone projects incorporate a mandatory rubric that requires students to include a section in their thesis where they reflect at the ethical implications and issues arising in their projects. This rubric is found to explicitly mention sustainability as one of the implications to be considered. For the programmes that do not yet have this requirement for the final year project, evaluators mentioned its absence and suggested the introduction of an ethics section.

Conclusion

Lambrechts et al. (2013, p.64) argued that higher education institutions are “far from reorienting themselves towards sustainability”, as sustainability appears to be “integrated in a piece-meal fashion”. While we can’t say that the implementation of sustainability is carried in a systematic and even manner

in the programmes in the study, what does emerge is a desire to address ethical issues through the prism of sustainability. Sustainability appears to be the most popular topic used to meet the accreditation outcome purporting to ethics. Sustainability might be a good candidate for the integration of ethics across the curriculum, as it can be tailored to the expertise of Engineering faculty and is appealing to Engineering students. The downside of this is that sustainability becomes associated with its environmental dimension and less the social and economic dimension. An issue then is how we can use this desire to focus on “ethics as sustainability” as a mechanism for broadening engineering education and more fully integrating the technical, the social, and the environmental dimensions of engineering in one comprehensive form of education. (Nicolaou et al 2018).

References

- Bielby, R., Harding, T. S., Finelli, C.J., Carpenter, D. D., Sutkus, J. A., Holsapple, M. A., Burt, B. A., and Ra, E. (2011). Impact of different curricular approaches to ethics education on ethical reasoning ability. *Proceedings of the 2011 ASEE Annual Conference and Exposition*, Vancouver, Canada.
- Byrne, E.P. (2012). Teaching engineering ethics with sustainability as context, *International Journal of Sustainability in Higher Education*, 13(3), 232 – 248
- Byrne, E.P., Desha C.J., Fitzpatrick, J.J., Hargroves, K. (2013). Exploring sustainability themes in engineering accreditation and curricula. *International Journal of Sustainability in Higher Education*, 14(4), 384–403
- Conlon, E. & Zandvoort, H. (2011). Broadening Ethics Teaching in Engineering: Beyond the Individualistic Approach. *Science and Engineering Ethics*. 17 (2), 217-232
- Cruz, J. A., Frey, W. J. (2003). An effective strategy for integrating ethics across the curriculum in engineering: An ABET 2000 challenge. *Science and Engineering Ethics*, 9(4), 543–568.
- Drake, M. J., Griffin, P. M., Kirkman, R., Swann, J. L. (2005). Engineering ethical curricula: Assessment and comparison of two approaches. *Journal of Engineering Education*, 94(2), 223–231
- Engineers Ireland. (2007). *Accreditation Criteria for Engineering Education Programmes*. <https://www.engineersireland.ie/EngineersIreland/media/SiteMedia/services/accreditation/Accreditation-Criteria-for-Engineering-Education-Programmes-FINAL-amended-Mar-09.pdf>
- Harding, T., Sutkus, J., Finelli, C., Carpenter, D. (2009). Engineering culture and the ethical development of undergraduate students. In *Proceedings of the research in engineering education symposium 2009*, Palm Cove, QD
- Lambrechts, W., Mulà, I., Ceulemans, K., Molderez, I., & Gaeremynck, V. (2013). The integration of competences for sustainable development in higher education: an analysis of bachelor programs in management, *Journal of Cleaner Production*, 48, 65-73.
- Mesa, J., Esparragoza I. and Maury, H. (2017). Sustainability in Engineering Education: A Literature Review of Case Study and Projects, in *15th LACCEI International Multi-Conference for Engineering Education, and Technology*, Boca Ratón, USA, 2017

- Monteiro, F., Leite, C. and Rocha, C. (2016). Ethics and Civic Education in the Curriculum of Engineering courses in Portuguese Higher Education System. *8th International Symposium on Project Approaches in Engineering Education (PAEE) and 14th Active Learning in Engineering Education Workshop (ALE) Proceedings*
- Newberry, B. (2010). Katrina: Macro-ethical issues for engineers. *Science and Engineering Ethics*, 16(3), 535-571
- Nicolaou, I., Conlon, E. and Bowe, B. (2018) Into the Deep: The Role of Paradigms in Understanding Engineering Education for Sustainable Development. *Irish Journal of Social, Economic and Environmental Sustainability*. **1** (2), 23-41.
- Ocone, R. (2013). Engineering ethics and accreditation. *Education for Chemical Engineers*, 8(3), e113–e118.
- Polmear, M., Bielefeldt, A.R., Knight, D., Canney, N & Swan, C. (2018). Faculty perceptions of challenges to educating engineering and computing students about ethics and societal impacts, *Proceedings of the ASEE Annual Conference & Exposition*
- Polmear, M., Bielefeldt, A.R., Knight, D., Canney, N & Swan, C. (2019). Analysis of macroethics teaching practices and perceptions in engineering: a cultural comparison, *European Journal of Engineering Education*
- Romkey, L. (2015, June). *Engineering, Society, and the Environment in the Teaching Goals and Practices of Engineering Instructors*, Paper presented at *2015 ASEE Annual Conference & Exposition*, Seattle, Washington
- Sinha, S. K., Thomas, R., & Kulka, J. R. (2007). Integrating ethics into the engineered construction curriculum. *Journal of Professional Issues in Engineering Education and Practice*, 133, 291–299
- Walczak, K., Finelli, C. J., Holsapple, M. A., Sutkus, J. A., Harding, T. S., and Carpenter, D. D. (2010). Institutional obstacles to integrating ethics into the curriculum and strategies for overcoming them. *Proceedings of the 2010 ASEE Annual Conference & Exposition*, Louisville, KY

Transdisciplinarity in a bio-engineering course

V. Massardier^{1,2,3}, S. Livi^{1,3}

sebastien.livi@insa-lyon.fr

¹ Department « Formation Initiale aux Métiers de l'Ingénieur »

² Department « Science et Génie des Matériaux »

³ Laboratory « Ingénierie des Matériaux polymères », UMR 5223,

INSA Lyon, F-69621, Villeurbanne Cedex

Abstract

In order to face environmental issues related to resource management and the protection of our ecosystems, future engineers must be aware of the need to develop new sustainable technologies.

Our multidisciplinary and transdisciplinary course aims at sensitizing students to the major challenges related to the environment and resources. In particular, bio-engineering for the production of biosourced and biodegradable polymer materials, waste treatment and recovery, as well as ecosystems remediation are addressed.

The aim of the lectures, in the first part of the course, is to introduce notions of ecology, biotechnology, polymer materials and process engineering, in order to prepare the project part which allows students to develop achievements on bio-based materials.

The students choose from four project areas: the design and construction of a biodegradation reactor, the production of enzymes by genetic modification of bacterial strains, the implementation and optimization of biodegradation processes, the development and transformation of polymer materials, in particular bio-based and biodegradable materials.

Finally, students are invited to consider the importance of interactions between complementary disciplines for the success of sustainable and responsible complex projects such as those in the field of bio-engineering.

Key words: Ecology, Bio-based polymers; Enzymes, Biodegradation; Process engineering; Human Sciences.

1. Introduction

With the growing expectations of consumers for taking environmental dimensions, it is a real challenge for the future of certain value chains to integrate environmental challenges but also to add a societal dimension to the CSR framework (Corporate Social Responsibility, ISO 26,000).

The value chain of polymers and products containing plastics presents major challenges both from a regulatory point of view (recycling rate to be achieved), from environmental perspectives (impacts on resources, pollution of the oceans), from societal (health impacts, jobs related to plastics) and technical (essential materials in certain applications) viewpoints. Research projects related to the development of alternative solutions for polymers (biosourced) and chemical recycling are expanding. It is therefore essential to ensure that the directions taken

from environmental and societal points of view will be economically sustainable and will have positive impacts as the changes imposed on the polymer value chain are important and complex.

In this context, in order to face environmental issues related to resources management and the protection of our ecosystems, future engineers must be aware of the need to develop new sustainable materials and technologies. As L. Ablin [Ablin, 2018], our course aims at engaging students with the complexity of the real world by a transdisciplinary approach [Tejedor, 2018]. It is necessary to find the conditions required, both socio-economic and in the field of materials science, allowing biosourced polymers to position themselves sustainably alongside conventional polymers. It is therefore essential to combine economic aspects (innovation economy, industrial economy, ecological economy, circular economy) with innovation resulting from the Material Design to bring about relevant solutions that can spread massively.

The interdisciplinary course we manage, aims at studying both engineering and societal challenges that should permit biosourced polymer materials to be able to i) integrate a circular economy or ii) undergo enhanced assimilation if unfortunately dispersed in natural media. Indeed, our present society model overexploits critical resources, which imposes a transition towards a circularity that is an European priority, associated with societal responsibility as well as environment protection. Unfortunately, part of polymer or plastic materials are dispersed in the environment, in which they can remain for tens of years, due to their stability. As an example, rivers and oceans are polluted by macro and micro plastics. Enhanced management of waste should be a way to reduce this pollution, but it might not be sufficient. Indeed, microplastics are produced by the inevitable abrasion of tyres, textiles... In this context, biodegradable polymer materials might be an interesting alternative to conventional non biodegradable materials, poorly assimilated in the environment.

From this point of view, students are invited to study several parts of the life cycle of recyclable, bio-sourced and biodegradable materials as well as to discuss on their societal interests. Recyclable, bio-based and bio-degradable materials represent a challenge for both engineering and societal sciences and it seems mandatory to associate ‘Material Design’ [Lins 2015, Livi 2015] with societal questions.

The objective of the course is to eco-design eco-friendly polymer materials [Quitadamo. 2018, Delamarche 2020a, 2020b] with ability for hydrolysis by enzyme catalysis as well as for biodegradation to make future engineers able to contribute to the sustainable development goals SDGs 9 & 12 of the United Nations that intend to establish « resilient infrastructure », as well as to promote a « sustainable industrialisation » “benefitting all and encouraging innovation as well as implementation of a responsible consumption and production”. In parallel, societal impacts of those new bio-based materials are debated.

2. Structuration of the core courses

Figure 1 displays the contributions of each discipline of the core courses and projects as well as their interactions in order to design environment friendly polymer materials. Courses deal with the management of resources and energy (depletion, dispersion), protection & decontamination of media & ecosystems, eco-compatible design (valorisation of waste), biotechnologies & polymer materials (life cycle, biodegradability), development of sustainable technologies for human being & environment. Societal challenges are discussed in a transverse way with points of view of human, life and material sciences. For example, circular economy and recycling imply not only technological innovation but also behavioral adaptations of the

consumers for ensuring quality of the collect and thus of the future recycled materials. Social acceptability as well as the image of recycled materials have also to be addressed. As the price of recycled bio-based polymer materials cannot exceed the one of virgin ones, that are only of a few euros per kg, recycling costs have to be low. Objects designed for easy disassembling can also offer great interest. Thus, it is important that engineer students be conscious of the socio-economical constraints associated with the development of new materials and objects. They have to consider those latter as well as the associated constraints for the design of both materials and objects.

Below is the courses list.

Ecology and environment sciences: knowledge, skills in ecology and ecosystems, environmental challenges of anthroposystems development, methods & tools for the sustainable management of anthroposystems.

Experimental enzymology: enzyme kinetics.

Biotechnology of DNA: genes and genome, genes expression and regulation, basics of synthetic biology, extraction of DNA.

Materials science for biosourced polymer materials: organic chemistry, basics on polymers, biosourced structures and properties, polymer processing, polymer materials & environment, study of mechanical & physico-chemical properties.

Process & chemical engineering for the modelisation of a bioreactor: chemical kinetics, reaction engineering, enzymology, growth models (introduction to ordinary 1-dimensional differential equations), chemostat model (introduction to dynamic 2-dimensional systems), inferential statistics (linear and non-linear adjustment of the Michaelis-Menten model).

Enzyme behaviour modelling: numerical simulation (Matlab) and self-centered programming (Python)

Human sciences: concept of technical culture, mode of existence of technical objects, invention and innovation, frugal innovation, waste management, innovation and sustainable development, imaginary and biotechnologies, major ethical issues of biotechnology and patentability of life, responsibility of the engineer.

Documentary research: Identification of information sources, research methodology, intellectual property, project monitoring.

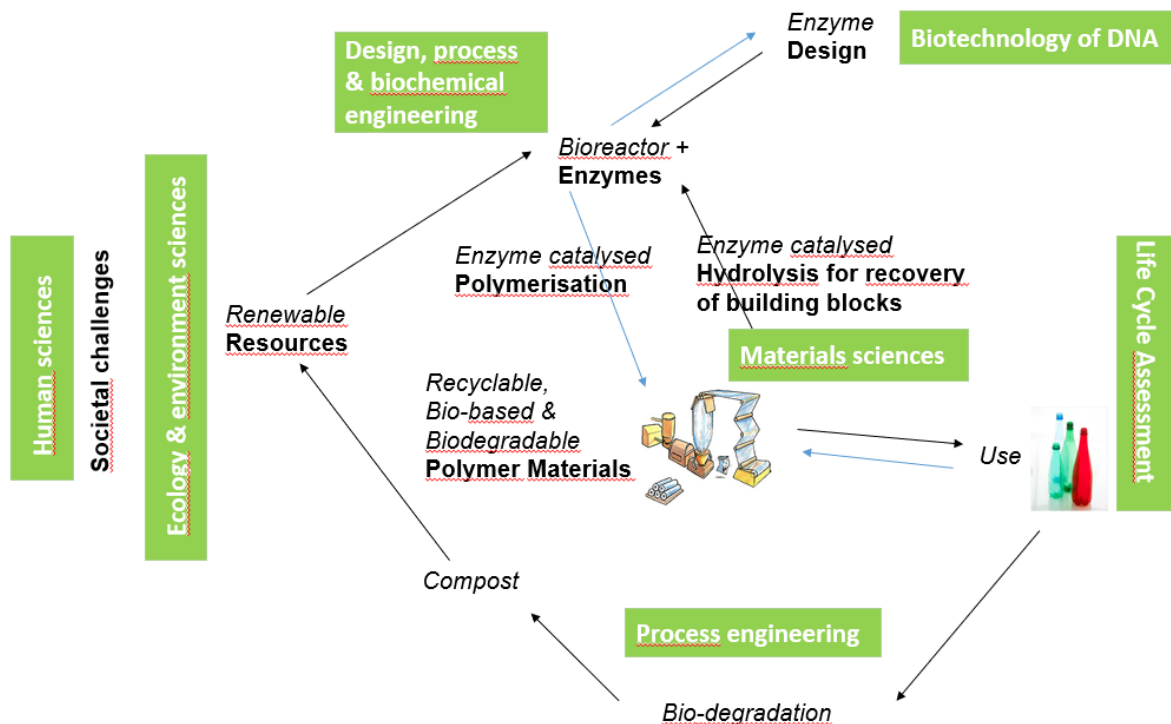

Figure 1: potential interactions and contributions of fields of study for a circularity of environment responsible bio-based polymers.

3. Complementary projects

In addition to the core courses, each student has to perform one out of four complementary engineering projects. In parallel, students are invited to discuss on innovation, ethics, responsibility of the engineers that are associated with the societal challenges of the course. Concerning the societal challenges, the students write an article on a topic related to their own project, the current state of society and the planet [Omotola, 2018]. This is an opportunity to think about the evolution of science and technology in relation to the preservation of our resources, ecosystems and humanity.

For the engineering part, the four complementary projects, at different stages of the life cycle, are described below.

Process Engineering Project. Materials Environmental Behaviour: this project deals with both the aerobic and anaerobic biodegradability as well as bio-treatment tests in pilot reactors.

Design - Manufacturing: Development of a fermentor for biodegradation of a bio-sourced polymer material. Design of fermentors such as respirometers, methanizers.

Synthetic biology, genetic modification of *Escherichia coli* and production of an enzyme for biodegradation: catalysis, design of new genetically modified (GM) bacterial strains to degrade biomaterials or design new ones, modelling of the functioning of an enzyme, analysis *in silico* of the α -amylase gene.

Biosourced polymer materials: Development and transformation of a biosourced polymer material for fabrication and characterizations (mechanical and physicochemical properties) of

objects such as meal trays, signaling tape, parachutes, plastic bags... Life Cycle Analysis (LCA) of paper and plastic packagings.

As depicted in Figure 1, in our interdisciplinary and transverse approach, the courses described above are used for thinking about a circularity of environment responsible bio-based polymers. In this perspective, the materials engineering component will aim to eco-design biosourced polymer materials with improved performances and differentiating characteristics in order to offer a great versatility of properties with an ability for material or organic (biodegradation in a compost, soil...) recycling. This scientific challenge implies, at the same time, a social analysis to identify the technological and socio-economic barriers related to the conditions of uses, and recycling of bio-sourced polymers that are essential for the deployment of a circular economy of these materials. As explained above, the success of circularity should be facilitated by anticipating the end-of-life when designing materials and objects, economically sustainable. It is ever known that “multi layered multi-materials”, that offer good gas barrier properties interesting for packaging applications are not easy to recycle. An alternative is to develop “multi layered mono-materials”, that may present different properties. Both the quality and quantity of waste collection are also key parameters for facilitating circular economy. It is important to understand how to increase them with deployment of economically sustainable technologies as well as the evolution of consumers behaviours. Quality should stimulate demand and acceptability of recycled materials. In this perspective, technological developments, communication as well as the image of the recycled materials could be considered in parallel.

Combining all the courses, complementary projects and working on inter-disciplinary interfaces, should give students the means to solve at least part of the very multidisciplinary issue related to the development of a circular economy of bio-based polymers.

The production of complementary knowledge related to Materials Science, Human and Social Sciences and at the interface between them, should contribute to the United Nations Sustainable Development Goals (SDGs) 9 and 12.

4. Conclusion & perspectives

The emergence of a circular economy of bio-based materials requires the lifting of not only technological but also socio-economic barriers. If the development of breakthrough innovations in chemistry and materials science is a first condition, the massive diffusion of these innovations in society requires a fine analysis of the value chains of the actors involved in the production and recycling of polymers. The interest of the course lies in its ability to mobilize the complementary and necessary skills for the analysis of these different locks and their interactions.

In this regard, students are invited to consider the importance of interactions between complementary disciplines for the success of sustainable and responsible complex projects such as those in the field of bio-engineering.

Students become aware that some answers can only be generated by working on inter-disciplinary interfaces. The initiation to research gives the means to solve at least part of the very multidisciplinary challenge of developing bio-sourced, recyclable and biodegradable materials with consideration of societal challenges.

As a perspective, integrating a depolymerization enzyme catalyst into a biosourced polymer as soon as the polymer is designed and activating the depolymerization agent under the effect of a stimulus (heat, light, etc.) would permit to go a step ahead.

As another perspective, we should also consider that the emergence of a circular economy of bio-based materials requires the evolution of not only technological but also socio-economic barriers, such as deployment of economically sustainable technologies, evolution of the consumers behaviours as well image of the recycled materials. In this regard, it might be relevant to develop deeper socio-economic analyses to inform and guide research planning.

References:

[Lins, 2015] Luanda C. Lins, Sebastien Livi, Jannick Duchet-Rumeau and Jean-François Gerard. Phosphonium ionic liquids as new compatibilizing agents of biopolymer blends composed of poly(butylene-adipate-co-terephthalate)/poly(lactic acid) (PBAT/PLA). 2015. RSC Adv., 2015, 5, 59082–59092

[Livi, 2015] Sébastien Livi, Valeria Bugatti, Manuel Marechal, Bluma G. Soares, Guilherme M. O. Barra, Jannick Duchet-Rumeau and Jean-François Gerard. Ionic liquids–lignin combination: an innovative way to improve mechanical behaviour and water vapour permeability of eco-designed biodegradable polymer blends. 2015. RSC Adv., 2015, 5, 1989.

[Ablin, 2018] Lois Ablin, Engaging Students with the Real World in a Green Organic Chemistry Laboratory Group Project: A Presentation and Writing Assignment in a Laboratory Class. 2018 . J. Chem. Educ. 2018, 95, 817–822

[Quitadamo., 2018] V. Massardier, A.Quitadamo. Contribution of reactive extrusion to technological and scientific challenges of eco-friendly circular economy, in the book "Biomass Extrusion and Reaction Technologies: New Insights, Future Potential, and Principles to Practices", ACS, 2018, A.S. Ayoub,L.A. Lucia Editors.

[Tejedor, 2018] Gemma Tejedor, Jordi Segalas, Martí Rosas-Casals Transdisciplinarity in higher education for sustainability: How discourses are approached in engineering education. 2018. Journal of Cleaner Production 175 29e37

[Omotola, 2018] Omotola O. Ogunsolu, Jamie C. Wang, and Kenneth Hanson. 2018. Writing a Review Article: A Graduate Level Writing Class, J. Chem. Educ. 2018, 95, 810–816

[Delamarche, 2020b] Delamarche E, Mattlet A, Livi S, Gérard J-F, Bayard R and Massardier V. 2020. Tailoring Biodegradability of Poly(Butylene Succinate)/Poly(Lactic Acid) Blends With a Deep Eutectic Solvent.Front. Mater. 7:7. doi: 10.3389/fmats.2020.00007

[Delamarche, 2020a] Emma Delamarche, Valérie Massardier, Remy Bayard, Edson Dos Santos. 2020. A review to guide ecodesign of reactive polymer based materials”, in the book “Reactive and Functional Polymers Volume 2” Topic : 20. Biodegradability and compostability of reactive and functional polymers, Springer, Tomy J. Gutierrez Editor. <https://link.springer.com/book/10.1007%2F978-3-030-52052-6>

Topic “Eng. Education; Incorporating Societal, Economic & Political Dimensions”

Eco-design, circular economy & social responsibility

V. Massardier^{1,2}, C. Subař³

valerie.massardier@insa-lyon.fr

¹ Departments « Science et Génie des Matériaux » & « Formation Initiale aux Métiers de l’Ingénieur »

² Laboratory « Ingénierie des Matériaux polymères », UMR 5223

³ Department « Génie Industriel »

INSA Lyon, F-69621, Villeurbanne Cedex

Abstract

Our lifestyle, associated with consumption of large amounts of resources, implies to integrate eco-design in our innovations. In particular, recycling and circular economy have to be facilitated, when designing a product. Life Cycle Analyses (LCA) enable to identify the most impacting stages for environment. They often demonstrate the positive effects of recycling that i) limitates the depletion of natural resources, ii) enables energy savings, iii) lowers dissemination of pollutants, etc. Courses as well as collective projects aim at bringing to light environmental issues of eco-design and circular economy, as well as the resulting questions for engineers & researchers. Social responsibility is also identified as key for circular economy and how to train for social responsibility is discussed. Invited speakers from academia as well as industry provide complementary answers to academic ones.

Key words:

Materials & processes, Eco-design, Circular Economy, Life Cycle Analysis, Social Responsibility.

With the growing technological activity of our civilizations, nature, which was regarded as invulnerable, as having gigantic and inexhaustible resources, today shows signs of disorder and impoverishment that can be directly connected with human activity. The resolution of the questions posed by sustainable development does not only concern sciences and technology but also social responsibility.

In this context, the idea of scientific progress without limits, is perceived as a potential danger related to scientific activity which does not know its consequences with certainty or precision. On the one hand, the conceptualization of sustainable development (in its ethical aspect) slows down the vision of a world in progress for which science, technology, computing power... enables everything to be envisaged. On the other hand, with sustainable development, scientists are asked to find solutions for the practical applications of a development comprising an even greater degree of control (Bourg & Erkman, 2017).

The ideology present in the concept of sustainable development thus appears as still strongly showing faith in science for the resolution of the problems for which technological activity is responsible. While moving towards a scientific application of sustainable development, it appears necessary to think about technological solutions to the problems arising from technology. While posing that the field of resolution of excesses of the technique is even in the heart of the technique, there seems to be no question of minimizing the use of technologies for our development but of reorientating those, to place them within a new conceptual framework allowing their use for sustainable development. Integrating sustainability in higher education is now a worldwide question.

In this context, trans-, inter-, pluri-disciplinarity and complexity inside the sphere of science, technology and also social responsibility seem to be fundamental keys for sustainable development (Massardier, 2014) (Subaï *et al.*, 2006), as the questions posed by sustainable development do not only concern science and technology.

Present developments, whether they concern technology, the environment, the economy or the social sphere, inevitably bring us face to face with the challenges of complexity. The pressure of facts creates the need for this, by the ever-increasing interaction between disciplines and society. Taking complexity into account means introducing a certain way of approaching the real world and defining a special relationship to the object which can only be efficiently elaborated within a pluridisciplinary framework.

The basic questions are always the same and do not only concern finding solutions to problems but also and especially working on the identification and the formulation of the problems themselves. What points of view, what aspects, what frontiers should be taken into consideration in order to treat relevant social problems? And, thereafter, how should we integrate these necessarily (at least partially) conflicting aspects in order to propose satisfying answers?

Once their basic training has been completed, engineers are most often called upon to intervene not merely on isolated technical objects but on socio-technical systems. These systems are often complex. They are also at the intersection of very different approaches (economic, social, technological, political, cultural). Understanding these systems means associating and combining several different viewpoints.

Our students have to acquire and develop an analytical competence and a capacity for a systemic approach and circular economy is a good subject for this. In other words, they need specialist competence and a capacity for pluridisciplinarity. This means that engineer training requires time to be devoted to studying areas of synergy between the specialist fields so that teachers and students are helped in their understanding process.

We are all well aware of the underlying objections to the choice of pluridisciplinarity. But is it really a question of choice? Do we really *have* a choice? Let us rather proceed by analogy with Edgar Morin's definition, according to which a system is both more and less than the sum of its parts.

The complexity of an object, a problem, a situation is the result of a decision. « We are all free to consider an object as simple, but we claim the right to decide on complexity ». By deciding on complexity, we also choose to foreground a new approach to science and consequently, to training.

The question of complexity can be seen as particularly important today, given the need to ensure circular economy, because sustainability brings us face to face with the complexity of the real world.

At INSA-Lyon, the training for circular economy (Massardier & Quitadamo, 2018) is at least available in the departments devoted to industrial engineering, materials science and engineering, associates "hard sciences" and social responsibility.

In perspectives of circular economy, eco-design for anticipating the end-of-life is a key point (Delamarche *et al.*, 2020).

Figure 1 schematises key steps of circular economy. Eco-design, including choice of raw materials, of processes and energy is a main stage for facilitating it. According to us, it requires knowledge as well as skills in disciplines such as chemistry, thermodynamics, physics, mechanics and materials science, associated with social responsibility, that should help choices at each steps of the life cycle. In particular, a relevant choice of the constituents of materials is particularly important as it may prevent recycling. For example, polymer formulations with brominated flame retardants are difficult to recycle, as they are more and more unwanted in new formulations.

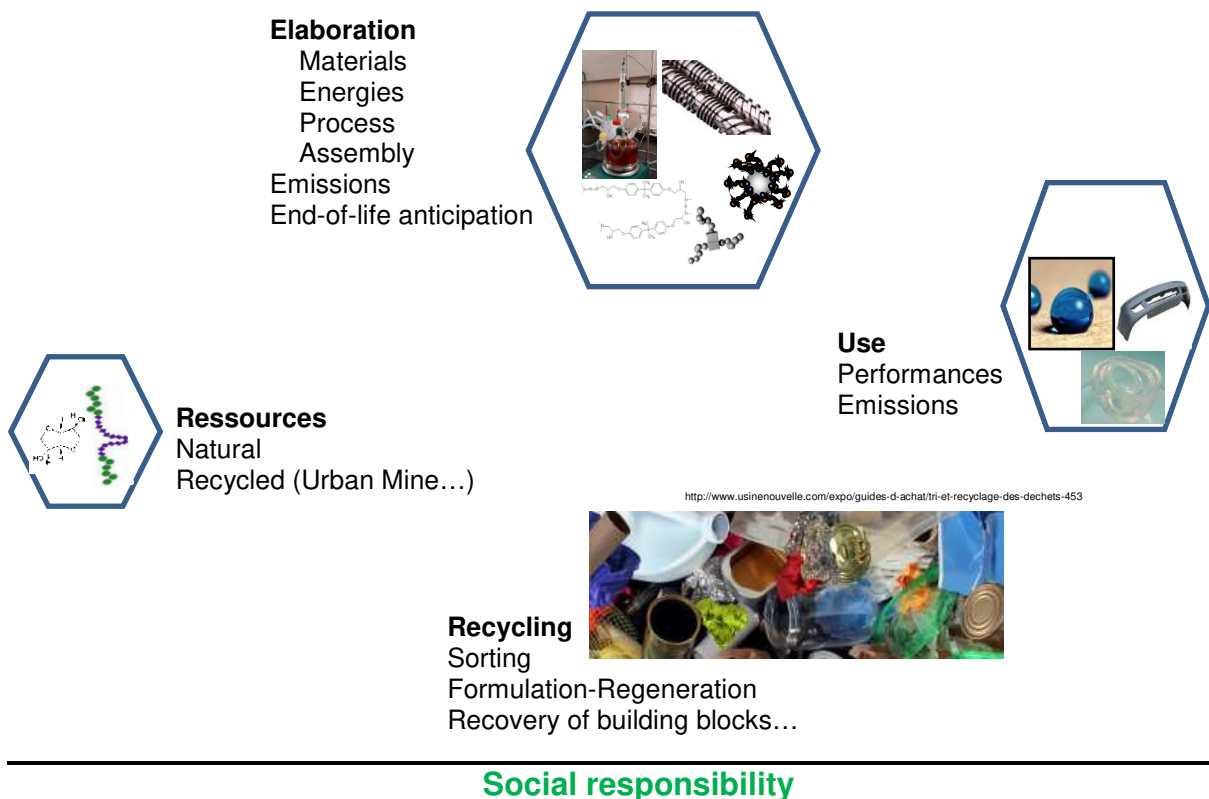

Figure 1: Materials life cycle displaying the need for knowledge as well as skills in disciplines such as chemistry, thermodynamics, physics, mechanics and materials science, associated with social responsibility.

In INSA Lyon, the teaching of social responsibility is often done at Levels Master 2 and often after a significant work experience which takes the form of an internship.

In the industrial engineering department of INSA de Lyon, the training is based on the experience of the students, which, although weak, makes it possible to understand the challenges of companies in a social responsibility approach. It starts with a serious game that provides basic knowledge in sustainable development and presents its challenges for the company. The game continues with a business scenario. First of all, it involves identifying the stakeholders and then making a diagnosis of the business by determining the expectations of external and internal stakeholders. These expectations are then translated into actions. The actions are chosen on the basis of 3 financial criteria and a multi-

year program over 5 years for the company, which constitutes an action plan. Each chosen action must be estimated a priori in terms of impact on 7 factors. The objective of this game, in addition to providing knowledge, is the presentation of possible concrete actions in business. The case study is done at all levels of the company.

This training has been supplemented by the intervention of 3 professionals. The first concerns sustainable purchasing, the second focuses on well-being at work and the last on physical preparation for work. Taking social responsibility into account seems to be an essential component of the educational model, so that engineers are able to argue in favour of its development. Social responsibility may have been opposed to profit. But it can be considered as an investment for a long-term profit. For example, anticipating probable evolutions of regulation, such as REACH, can strengthen a company by enabling it to be a step ahead. Some investment funds, at least, also encourage companies to develop social responsibility and it is important to form engineers able to help in its development. Social responsibility can be considered as a key for circular economy, by eliminating hazardous components to facilitate recycling. For example, recycling of polymer formulations containing hazardous flame retardants or plasticizers such as phthalates, is practically impossible, as it would imply to separate the flame retardants or plasticizers from the polymer matrices. Unfortunately, this separation would be too expensive. Thus, the lack of anticipation when formulating does not permit recycling, with loss of material resources. Moreover, environment impacts are also associated with economical costs

In the meantime, currently, training in social responsibility is taking place as follows: training through serious game, awareness of the responsibility of the engineer and finally training in the implementation of a social responsibility approach. The latter is done in the form of an innovative pedagogy at INSA, it is based on collective intelligence, the idea is to make the student actor and decision maker of his training. It is up to the student to propose the teaching method. This pedagogy is perfectly suited to the teaching of social responsibility. It has its strong points: the involvement of students, the possibility of finding new forms of training, the responsibility of the student in his training. It also has its weaknesses: a lack of investment for some because of the freedom left, the lack of organization, the evaluation which remains difficult. This type of pedagogy is however favored by the students. It will surely be extended in other departments.

To conclude, circular economy requires not only skills in engineering sciences but also social responsibility. As examples, sorting technologies require background in physics for density based methods and spectroscopy for more selective sorting.

Formulation and regeneration require knowledge in chemistry as well as process engineering.

Considering Life Cycle is a way to discuss on global warming, toxicity, ecotoxicity, resources depletion, and also on social aspects. The economical and environment aspects are also discussed, with emphasis on both money savings and benefits on environment often associated with recycling.

Lectures, tutorials as well as projects contribute to our training in circular economy and corporate social responsibility.

References

Dominique Bourg & Suren Erkman, 2017, Perspectives on Industrial Ecology, ISBN 9781351282079 - Editor Dominique Bourg & Suren Erkman, Publisher Taylor and Francis.

Emma Delamarche, Valérie Massardier, Remy Bayard, Edson Dos Santos, 2020, "A review to guide eco-design of reactive polymer based materials", accepted in the book "Reactive and Functional Polymers Volume 2" Topic: 20 Biodegradability and compostability of reactive and functional polymers, Springer, Tomy J. Gutierrez Editor

Massardier V., 2014 “Recyclable and bio-based materials open up new prospects for polymers : Scientific and social aspects” in the book Environmental impact of polymers. Wiley, Th. Hamaide, R. Deterre, J.-F. Feller Editors, DOI: 10.1002/9781118827116.ch12

V. Massardier, A. Quitadamo, 2018, “Contribution of reactive extrusion to technological and scientific challenges of eco-friendly circular economy”, in the book "Biomass Extrusion and Reaction Technologies: New Insights, Future Potential, and Principles to Practices", ACS, 2018, A.S. Ayoub, L.A. Lucia Editors

C. Subaï, P. Baptiste, E. Niel, 2006, Scheduling issues for an environmentally responsible manufacturing: the case of Hoist Scheduling in an Electroplating line, IJPE (International Journal of Production Economics) vol. 99 n° 1-2 p74-87

Combining Sustainable Design Education with Research on Pathway to Zero Energy Historic Buildings

K.McCartney & K. Busby

Centre for Architectural Education, University College Cork & Munster Technological University

k.mccartney@ucc.ie

Abstract

This paper describes an attempt to bring together the Teaching & Learning experience of students of architecture, a live research project, and the collaboration between leaders of separate modules in order to provide a more integrated educational experience. Cork Centre for Architectural Education (CCAЕ) provides professional degrees which are recognised under the terms of the EU Directive on Professional Qualifications (Architecture). One of its distinguishing features is the inclusion of a Building Conservation module in the third year of its five-year programme. This module is delivered mostly by architects, engineers and historians who also provide professional services in this specialised area. The Third Year Design Studio usually responds to this specialist resource by setting students a design project which involves design for re-use, adaptation, or extension to an existing, and often historic, building.

In 2019, CCAЕ became the Lead Partner in a Northern Periphery & Arctic Region Programme project entitled “Energy Pathfinder – Towards Zero Energy Standards in Historic Buildings”, supported by the European Regional Development Fund. Partners in five countries are studying techniques to reduce energy demands and supply renewable energy to meet the balance of energy requirements in Historic Buildings, and to disseminate guidance.

The new, stricter Zero-Energy-Building regulations that have been introduced throughout Europe present considerable challenges and opportunities to product manufacturers, builders, engineers and architects. However, the difficulties are multiplied when dealing with historical buildings, which are often granted exceptions from the strictest energy regulations. The design for retrofitting insulation, for example requires an understanding of the priorities for conservation in different buildings, as well as the skills required to prevent retrofitted insulation and draft stripping from causing problems of condensation and subsequent visual discoloration of finishes, and fabric deterioration. This requires a degree of sophistication in hygrothermal modelling, not always required in new-build design projects. Furthermore, the deployment of renewable energy systems such as photovoltaics, aerogenerators and heat pumps usually demands the installation of large equipment that might detract from the historical environments that society wishes to maintain. The visual impact of these technologies on historic buildings often leads to their rejection.

The research programme requires the creation of demonstration projects in different countries. The building selected as a demonstrator in Cork, the re-use of a large, building used most recently by a religious order. This site was also selected as a conservation-related project for Year Three students.

This paper examines the range of student proposed solutions, and the potential benefits of meshing a live research project into a teaching curriculum, which itself merged five distinct taught modules.

Introduction

Analysis plays an important role in achieving a design output that meets specific needs, However the product of Design is more essentially synthetic as distinct from analytic. Design seeks to bring together solutions to many, often poorly defined, needs. The elegance and efficiency with which a single design can respond to these requirements is what marks successful design products. For this reason, many involved in the teaching and learning of design skills, are challenged by the dominant model of Higher Education which requires learning to be broken onto distinct modules with enumerated Learning Outcomes, each of which might involve developing specific skills. These models are often based on the assumption that fitting the parts together at the end is the easy part, and this synthesis is sometimes left to the student.

This paper describes an exercise in which externally funded research, is closely linked with the Teaching and Learning in Year-3 of a five-year programme leading to the award of a Master of Architecture. Furthermore, it demonstrates some results from linking of five, separate taught modules in Architectural Design Studio, Applied Technology, Conservation and Environmental Design, spanning across two semesters. A shared aim for each module, is to increase a student's ability to contribute to a sustainable built environment. Conservation and creating new functions for old buildings, contributes to social value, and greatly reduces the embodied energy invested in our built environment. Environmental Design aims to create healthy, comfortable, fit-for-purpose buildings. Applied Technology increases awareness of material properties and the design value of specifying and combining appropriate materials and components. The Design Studio classes aim to combine all these functions and others, into a harmonious whole.

Research Programme

The research programme and the educational programme were separately approved and funded. This paper highlights specific advantages to both the research and the educational outcomes, achieved at the cost of additional time devoted to organization and collaboration. The research is part of 'Energy Pathfinder: Towards Zero-Energy in Historic Buildings,' a three-year project funded by the Northern Periphery and Artic Programme of the European Regional Development Fund. The research programme, led by UCC, involves partners in the Faroe Islands, Finland, Ireland, Scotland and Sweden. It included demonstration sites where the energy upgrades can be applied. The principal focus for UCC is Myross Wood House, a country estate with a large building built early in 1820 as a private house, but later purchased by a religious order for training purposes. This house is not of outstanding architectural merit, but it is included in the National Inventory of Architectural Heritage (of Ireland). And it has played significant role for the local community as a centre for religious activity. The research programme explicitly addresses the importance of social value as well as architectural value in considering the conservation requirements of historic buildings.

Educational Programme

As a result of the research programme, there two significant reports on Myross Wood House were available before students became involved. Carrig Architects (2020) described the property and its history, and Akiboye Conolly Architects addressed the thermal properties of its construction, its energy demands and potential renewable energy sources. These reports were not delivered to students at the outset but were available to teaching staff. It was intended that students undertake their own investigations and develop strategies in response to their own assessment of the relative value of the different parts of the building. More detailed knowledge was introduced as the student project progressed.

In this way it was intended to simulate the experience of the professional consultants who had produced the two reports.



Figure1: View from East of Myross Wood House in County Cork, a demonstrator in the Energy Pathfinder: Towards Zero Energy for Historic Buildings research programme. To the right, is the original entrance wing facing North-East, to the left is the 1950's reconstructed wing facing South East.

Students were introduced to the project in the Architectural Design Module (AT3001) in Semester One. Three linked projects were set as assignments spanning a total of 10 weeks study:

- i) case study of a successful building conservation project coupled with new development to bring new use to a long-established educational site owned by a religious order. [1 week duration]
- ii) design study – making an intervention in the Myross Wood House fabric, with a view to linking the existing building to new development to provide a countryside annex to a city-based School of Architecture. [3 weeks duration]
- iii) major design project to produce plans for a new School of Architecture Annex on the grounds of Myross House, linked to the existing building. [6 weeks duration]

In Semester Two, a fourth project was set:

- iv) revisit & design in more detail, the intervention in the existing building. [3 weeks duration]

The first stage (i) was supported by a second module in Building Conservation (AT3002) in which the Architects for the conservation case study project (JCA Architects) provided on-site tours and lectures explaining the methods they adopted in selective demolition and restoration to bring new life to a mostly redundant complex of buildings constructed over a period of four centuries.

The second stage (ii) was intended to concentrate the attention of students on an evaluation of the existing buildings, which parts should be preserved, revealed, modified or replaced, and to consider the value of the existing building in relation to the new development of the site, for which they would soon be developing proposals.

The third stage (iii) was intended to challenge students to develop their design skill in generating proposals for a building(s) with complex challenges some of which were:

- location on site (relative to access, services, the existing building, site contours)
- orientation (with regard to views, slopes, solar access and access to north light for drawing studios)
- circulation and universal access
- responding to a specific user group

In the following semester, (project (iv)), an additional 3 weeks was devoted to developing the aspect of intervention in the existing building. Students, having now completed the design of the new development, were asked to consider in more detail their intervention in the existing building, taking account of construction details and the environmental design considerations that arise when connecting old and new building materials, and retrofitting insulation to traditional building fabric and integrating renewable energy systems. This involved cooperation between lecturers and tutors in three modules: Architectural Design (AT3005), Applied Technology (AT3007) and Environmental Design (AT3006).

At the time of writing this paper, students were still engaged in their second semester work. Therefore, the paper will describe student outputs from Semester One, and some preliminary outputs from Semester Two.

New Development Proposals

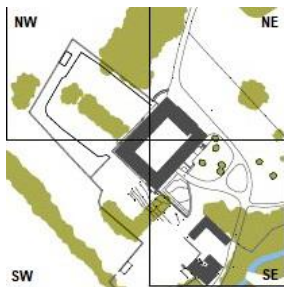

Figure 2 Main entrance to SE



Figure 3: Majority of student development proposals located to NW to SW



Figure 4: Access links through NW & SW wings

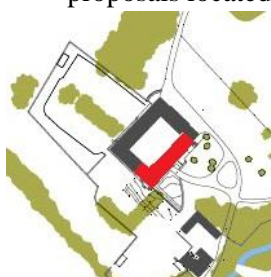

Figure 5: New construction within the SE wing maintains courtyard integrity

Thirty-six students participated in this study. Each produced individual proposals. There were however some patterns observed in their approach to siting new development. 78% of students located their new development to the north-west, west, or south west of the existing building.

All students used the existing building as a link to enter their new school design scheme (project-c), but most only used it as an entrance rather than putting significant accommodation into existing spaces. Only a small handful used the formal entrance hall within the 18thC, where the existing access road approaches the property (Figure 2) as the entrance to their scheme, mainly due to access problems, given a complexity of existing level changes. The majority related the entry to new or existing entrance to the courtyard of Myross Wood House.

Most students located their new developments to the North-West, West and South-West of the existing building (Figure 3). No students selected the NE quadrant as there was an appreciation that the 18th century landscaping to the front of the original Myross Wood House was too sensitive for redevelopment. New development there would have a detrimental effect on both the aspect and prospect of the front façade.

Several students selected the existing NW and SW wings as a location for their link to the proposed new development, providing access across the existing courtyard and through to the sloping gardens to the NW and SW (Figure 4). In these locations an existing, substantial garden wall was a popular reference feature for locating new-build elements. It offers opportunities for several bioclimatic design advantages which could reduce heating demands:

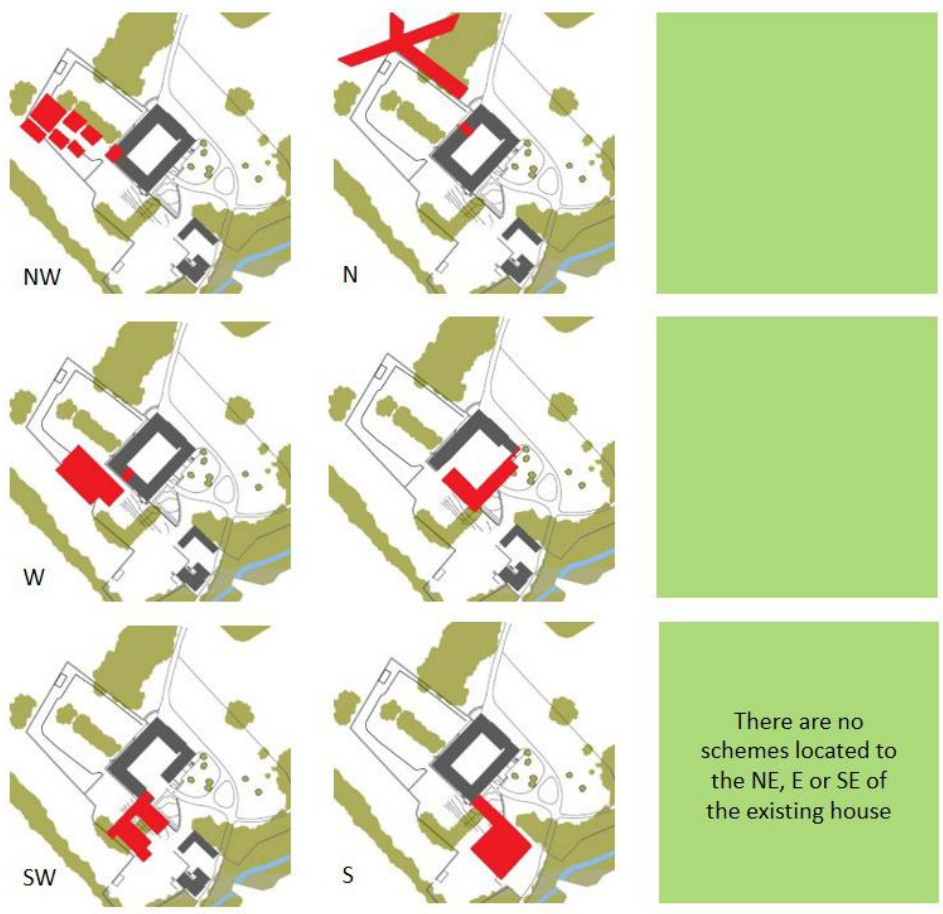

Figure 6: Matrix showing proposed new development locations relative to the house

Design Interventions (modifications to the existing building)

- gently rising slope facing SE with potential morning access to solar gain
- protection from predominant westerly winds (& controlled views to walled garden)
- potential for passive solar heat gain through S, and SE facing glazing

A small number of students chose to demolish the 1959 wing, either as a means of opening up the courtyard or to provide the location for their new accommodation and thereby maintain the integrity of the original courtyard space (Figure 5). The variety of site layout options explored is represented in Figure 6, which illustrates examples of the development proposals on all sides of the Myross Wood House, except the North-East.

In the third project (c) students presented their solutions to expanding accommodation with new construction adjacent to and linked to the existing building. Current opinion on such intervention in historic buildings is that new construction should not imitate the old construction, but rather juxtapose new materials and techniques to clearly demonstrate what elements and materials are new, and which are historic. Where old and new meet, the junction should be clearly expressed, rather than seamlessly merged. One of the most influential proponents of this approach was the architect Carlo Scarpa. “Scarpa was primarily interested in ... historical clarity, making history visible by the coexistence of overlaying fragments of construction.” (Murphy, 2018, p14)

Several proposals utilised the courtyard as a hub of circulation, both to link wings of the existing building, and to access the proposed new construction. In several examples this was achieved by (a) adding covered external walkways (Figure 7). Other students enhanced long internal corridors by introducing natural light



Figure 7: *In the final stage, students developed a more detailed proposal for the intervention with the existing building including proposals for materials and environmental control. (Caimin Muldoon, 2021)*

and sunshine, through the introduction of roof ridge glazing to the existing building (Figure 8), and by introducing views on to sunlit areas at the ends of pedestrian routes through the building (Figure 9).



Figure 8: Enhancing circulation corridors by introducing building natural light through ridge glazing on the roof (Matthew Hurley, 2021)

Figure 9: Enhancing routes through the by creating sunlit prospects. (M.Hurley 2021)

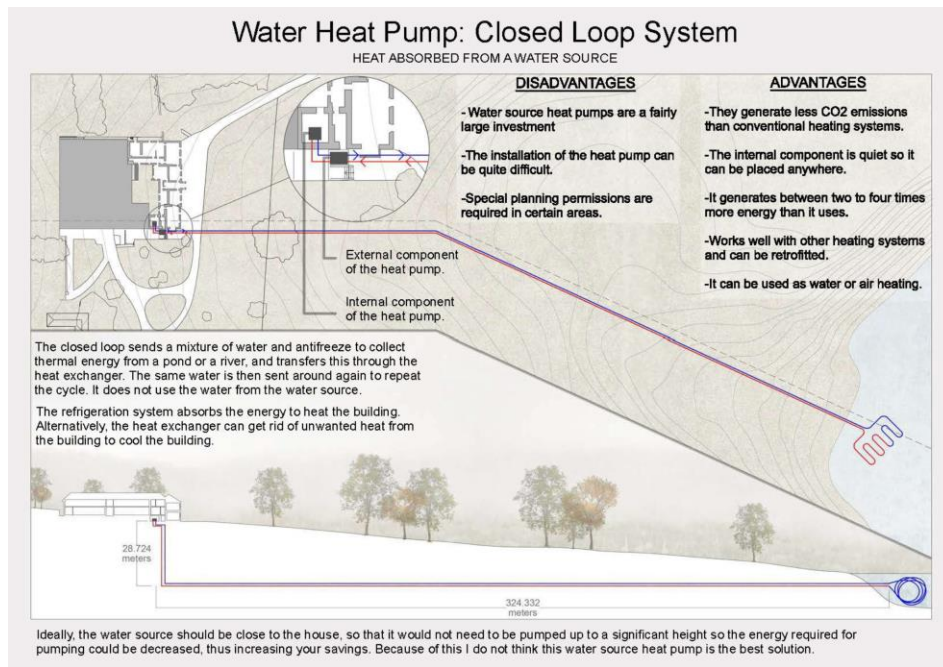

Figure 9: Landscape intervention required for a water-source heat pump in lake Myross Wood House (Klaudia Stasiak; D. Roche; A. Yuhhi; S. Williamson, 2021)

In project (d), the Environmental Design module required students to produce group reports on enhancing the thermal performance of individual elements of the existing building, and later to work individually to propose a coherent design for upgrading the whole building and selecting an appropriate system of renewable energy. The requirements for a water-source heat pump are examined in Figure 10.

Conclusions

Although a formal evaluation has not yet been carried out, anecdotal evidence points towards a conclusion that the collaboration between research and teaching, and the collaboration between five different modules created benefits for all stakeholders.

By linking together five different modules it is hoped that it will become clear to students that many different perspectives and skills need to be brought together in order to achieve successful solutions to the complex requirements imposed by the demand for sustainable buildings. Students might also have benefitted from the objective knowledge established in the research project reports, and from interacting directly with experienced professionals who had studied the same issues before them. Dealing with the interconnections between many issues that were formerly raised in separate modules with disparate and unconnected case studies may also have added to the perception of an integrated programme and a sense of the 'connected curriculum'.

Researchers reported that their understanding of Myross Wood House was enhanced by repeatedly describing it to groups of students and attempting to answer their questions. Seeing the range of design proposals produced by 36 students also gave a unique opportunity of examining alternative solutions developed in more detail than would typically be possible by a research team working alone.

Teachers observed the benefits of connecting distinct modules by sharing the same site for project work. This did come at the cost of increased time devoted to coordination of timetables and lecture inputs. However, there were also some savings in preparation time, brought about by in sharing briefing materials such as site drawings and descriptions.

References

Carrig Architects, 2020. *Conservation Report on Myross Wood House*, for Northside Community Enterprises, Cork City, Energy Pathfinder Project funded by Northern Periphery & Arctic Region.

Conolly Akiboye Architects, 2021. *Energy Upgrade Study, Myross Wood House*, Northside Community Enterprises, Cork City, for Energy Pathfinder Project funded by Northern Periphery & Arctic Region.

Murphy, Richard, 2018. *Carlo Scarpa and Castelvechio Revisited*, Breakfast Mission Publishing.

Myross Wood House (reg No. 20914210) National Inventory of Architectural Heritage
[Myross Wood House, ARDAGH, CORK - Buildings of Ireland](#)

Walking the walk; meaningfully engaging people with engineering challenges

Connor McGookin¹², Brian Ó Gallachóir¹² and Edmond Byrne¹²

¹School of Engineering, University College Cork, Ireland

²MaREI Centre, Environmental Research Institute, University College Cork, Ireland

connor.mcgookin@ucc.ie

Abstract

Barriers to the development of renewable energy generally involve non-technical as well as technical challenges, that are dynamic and context dependent. In the case of opposition to large-scale wind energy and overhead transmission lines for example, existing research reveals a complex and diverse range of conditions that shape public perception. However, conventional engineering practices tend to focus on least cost techno-economic evaluation methods such as cost benefit analysis. Here we use the case study example of Ireland's North-South interconnector project to demonstrate how a narrow focus on techno-economic analysis resulted in failure to adequately incorporate broader socio-political considerations. It demonstrates that the primarily technocentric worldview, which largely pervades engineering teaching and practices, can cause tensions and inertia, slowing the rate of progress along the low carbon transition. This, we argue, points to the need for a cultural / ethos change in engineering education and practice. Engineers should be encouraged and educated to broaden their perspectives and take a more reflective / pragmatic approach to engineering challenges that embraces the diversity of worldviews within our society. We hypothesise that the clear (and necessary) emphasis within engineering curricula on solving purely technical / mathematical problems may foster a reductionist hubris in engineering practice. To address this, contemporary fit-for-purpose curricula necessitate the inclusion of coursework that considers broader societal complexities, including so-called 'wicked problems' such as infrastructure projects, which involve placing engineering solutions in broader societal contexts.

1 Introduction

The European Union ambition of achieving carbon neutrality by 2050 will require radical changes in how we use and generate energy. An integral part of meeting this goal is the complete decarbonisation of electricity networks, which has prompted two fundamental transformations. Firstly, an increase in the levels of decentralised electricity generation due to small-scale systems like solar PV and secondly, a significant increase in the number of variable renewable sources being connected to the electricity grid. Both of these developments will require upgrades to the transmission network in order to ensure a stable and reliable supply of electricity into the future. In particular, dependency on variable sources of power necessitates an increase in the level of interconnection between countries, so electricity can be easily transported during periods when generators like wind turbines are unavailable. However, new installations of overhead transmission lines have sparked a significant amount of local opposition.

Literature on the topic of public perceptions to overhead high-voltage transmission lines has explored a number of differing reasons for local opposition, highlighting that public responses to infrastructure are complex and context dependant. Firstly, a significant number of studies focus on local beliefs and value sets, concluding that visual impacts on rural landscapes are a key driver of opposition to high voltage lines, so-called NIMBYism (Devine-Wright and Batel, 2013, Lienert et al., 2017, Tempesta et al., 2014), while others suggest that health-related concerns are the primary cause of resistance

(Stadelmann-Steffen, 2019, Bertsch et al., 2017, Wadley et al., 2019). Secondly, research on the institutions involved and the local planning process has highlighted additional considerations regarding procedural justice and the level of public trust in transmission system operators (Aas et al., 2017, Knudsen et al., 2015). Knudsen et al. investigating local perceptions of procedural justice in four electricity transmission grid projects from Norway and the UK, found that across all cases the level of local involvement in planning decisions was insufficient and unjust. (Knudsen et al., 2015) A key finding from both countries was the perception that the outcome had already been decided prior to the public being engaged.

The above literature highlights that the placement of overhead transmission lines is a very delicate matter requiring a careful engagement process to understand the social and political considerations of a project. These subjective design requirements make the design of large-scale infrastructure projects a highly complex wicked problem, which cannot be simply understood through the completion of a least-cost design process. This is precisely where conventional engineering approaches fall short. The reductionist hubris that dominates engineering practice means that the socio-political considerations are an afterthought. The engagement of the relevant public is primarily to encourage agreement with a particular solution, as opposed to a prerequisite that can provide insight into the context within which the system will eventually be placed.

In Ireland, and across Europe, infrastructure developments such as overhead pylons and wind farms have generated a significant amount of local opposition. According to a pan-European survey of local opposition to new transmission lines, 45% of Irish respondents chose “*definitely not accept without opposition*” compared to an EU-wide average of 33%. One interesting case to explore is the North-South Interconnector project, connecting the grids in Northern Ireland and the Republic of Ireland. Originally proposed in 2005, it is still stuck in a stalemate over a decade later. EirGrid Group, the state-owned company responsible for the management and operation of the transmission grid across the island of Ireland, see the project as vital to the development of the grid in order to ensure power system adequacy and manage the increased levels of variable renewable generation necessary to meet Ireland’s decarbonisation targets. However, progress to date has been slowed by repeated planning applications sparking a significant amount of local opposition. This has been primarily organized through the North East Pylon Pressure group, which has campaigned for an undergrounding of the cables due to health and well-being concerns.

This paper will use the example of the North-South interconnector project to highlight how traditional engineering practices may hamper progress with key infrastructure projects. Section 2, provides an overview of the case study, focusing on the initial years of the project and developments that sparked tensions between the two sides. The ways in which engineering practices contributed to the tensions are then explored in Section 3. Section 4, reflects on the learnings that may be taken from this experience, in particular arguing that complex problems such as infrastructure projects necessitate a more holistic approach.

2 Case study; The North-South interconnector project

For the purpose of this paper, two key periods in the early development of the North-South interconnector project are discussed in detail; the initial public engagement (October 2007 – February 2008) and the first formal planning application (April – December 2009).

2.1 Initial public engagement, October 2007 – October 2008

In September 2007, EirGrid published a booklet on three potential corridors for the new overhead high-voltage line (OHL) connecting the grids between Northern Ireland and the Republic. A month later, in October 2007, a four-month public consultation formally began (EirGrid plc, 2007a). In line with this, three Information Open Days are held in effected areas, a telephone/email service is launched and a leaflet is distributed through local newspapers (EirGrid plc, 2007b). The North East Pylon Pressure (NEPP) formed in November 2007, amidst growing public concerns about health and environmental impacts, the group sought to mobilize a campaign for underground cables (UGC) (North East Pylon Pressure, 2008). Eirgrid then published a press release on the benefits of major electricity investment and returned for three more open days with discussion specifically focused on the issue of EMF and overhead / underground power transmission (EirGrid plc, 2007c).

Following closure of the public consultation process in February 2008, the Department of Communications, Energy and Natural Resources commissioned an independent study on the alternatives to overhead transmission lines, and held a one-month consultation on the topic. In total 522 stakeholder submissions were received, from inhabitants of affected areas and external consultants for groups opposing the project (Ecofys Germany GmbH, 2008). In May 2008, a comprehensive report on the merits of OHL versus UGC was published (Ecofys Germany GmbH, 2008). This study highlighted how international best practice, along with comparisons of techno-economic considerations and environmental impacts make OHLs the favourable solution. NEPP responded by commissioning a German consultancy, ASKON Consulting Group, to investigate the comparative merits of underground cables versus overhead lines for the proposed North-South interconnector (ASKON Consulting Group, 2008). In October 2008, ASKON published their analysis in a report, recommending two parallel underground AC cables on the basis that it would be cheaper and more reliable in the long-term.

The lines in the sand were by now drawn, with each side brandishing their own expert report highlighting the merits of their favoured solution. This marks the beginning of a stalemate that failed to reach a compromise; the contradictions between these two reports remain the point of tension during exchanges in the years to follow.

2.2 First formal planning application, May – December 2009

In February 2009, Northern Ireland Electricity and EirGrid published a report providing a detailed comparison of High Voltage AC UGC, High Voltage DC UGC and the OHL currently proposed (Parsons Brinckerhoff, 2009). RPS Planning & Environment on behalf of EirGrid, published in March 2009, a multi-criteria evaluation of the three OHL corridors originally proposed (RPS Planning & Environment, 2009). This evaluation identified the route that purported to meet the best balance between the various technical, environmental and community evaluation criteria. EirGrid announced a month later in a community brochure that they had chosen the preferred route corridor identified by RPS Planning & Environment (EirGrid plc, 2009a). In addition, a detailed technical document was published highlighting the various third party reports considered and responses to a number of NEPP submissions (Eirgrid plc, 2009b). The project was then moved to the next stage of planning, which involves meeting with affected landowners and discussing their concerns and mitigation options.

The NEPP group responded in May 2009, publishing, “*A Powerful Challenge; Achieving a green grid for a green island*” (North East Pylon Pressure, 2009). The report launched an attack on EirGrid accusing them of being biased towards an OHL solution and questioning the objectivity of the experts that produced reports on their behalf. It also called for an All-Party Electricity Infrastructure Committee

to be established as well as a re-evaluation of EMF compliance levels with reference to a government report on EMF health effects. (Department of Communications, 2007)

Following a number of landowner consultations, a set of recurring questions about health and property values were published within a frequently asked question (FAQ) document in July 2009 (EirGrid plc, 2009d). Later that year, in December 2009, despite the significant amount of local concerns expressed regarding well-being and environmental impacts, EirGrid submitted a formal planning application to the state board, An Bórd Pleanála. (EirGrid plc, 2009c) In addition, an updated FAQ document was released in January 2010, addressing some additional queries that had been received since the previous edition (EirGrid plc, 2010b).

2.3 *As it stands*

Following the withdrawal of the original planning application in June 2010, (EirGrid plc, 2010a), there were no significant developments until July 2011 when the Minister for Communications, Energy and Natural Resources appointed an International Expert Commission to investigate the possibility of UGC (Normark et al., 2012). This marked the beginning of a re-evaluation period that lasted up to June 2015 when a revised (OHL based) submission was made, which was subsequently granted planning permission in December 2016. However, the NEPP have continued the fight, appealing the decision in the High Court and most recently the Supreme Court (Hussey, 2019).

Throughout the period of 2011 – 2018, both EirGrid and the Irish government again commissioned a number of different expert reports. An independent commission was formed twice, investigating the possibility of UGC (Normark et al., 2012, Normark et al., 2018). EirGrid updated previous analysis comparing the cost of OHL versus UGC (Parsons Brinckerhoff, 2013) and both separately commissioned consultants to explore the impacts of OHL developments on property values (Insight Statistical Consulting & Corr Consult, 2016, KHSK Economic Consultants, 2018). However, none of these actions served to relieve the tensions.

3 Analysis; Key causes of conflict

The two key causes of tension that will be discussed in this section may both be seen to emerge from the technocentric worldview that dominates engineering education, in particular we highlight how conventional engineering practices meant the public were not meaningfully engaged with the project.

3.1 *Prioritising techno-economic assessment*

As noted earlier, a perception locally that key design considerations have already been decided by the transmission system operator before the public engagement process takes place leads to a lack of trust and feelings of exclusion (Knudsen et al., 2015). This issue emanates from the way in which engineers tend to approach design problems. A full technical feasibility study and cost assessment will likely be carried out prior to the project being made public and a consultation being opened. This means that socio-political considerations are not given equal weighting to the techno-economic considerations. The engagement of the public is somewhat tokenistic, as its purpose is not to understand local knowledge and beliefs but rather to encourage compliance with a particular project or development.

This is quite apparent in the case study example. EirGrid identified three potential OHL corridors before beginning its public consultation. The exclusion of UCG from the original proposal and early statement by EirGrid that its policy is to develop OHLs is one of the key points that sparks the formation of the opposition group. (North East Pylon Pressure, 2008) In the words of NEPP;

- “they have approached the projects solely on a one-dimensional engineering basis” (North East Pylon Pressure, 2009)
- “There is a significant weakness in the approach by EirGrid of focusing solely on technical and engineering aspects of grid performance and development”. (North East Pylon Pressure, 2014)

The use of cost-benefit analysis (CBA) to argue for the OHL solution then only stands to deepen the divide between the two groups. As seen in other studies on pan-European transmission plans, CBA is often represented as robust objective evidence, but in reality is underpinned by a series of value judgements and thus is not the ‘neutral’ means of representing a problem that it may often be characterised as (Schmidt and Lilliestam, 2015). This affirms the local community’s suspicions that the transmission system operator is biased towards a particular solution rather than easing tensions.

3.2 Engineering arrogance

A direct consequence of the approach discussed in Section 3.1, is that engineers tend to view the world as an objective truth that is based on indisputable facts. However, reality is not an objective truth or fact but rather “includes the ways in which the people involved with the facts perceive them”. (Freire, 1982) When dealing with projects such as large-scale infrastructure projects that must be situated in broader socio-political contexts, efforts to address the concerns raised by the public, only stand to add to growing tensions whenever expert knowledge is used to provide a counter argument against local opinion. This infuriates the community, who feel an institution that is supposed to work for the good of the public has ignored their concerns. The engineer that has been trained and educated to believe everything can be solved through rational explanation finds her/himself at odds with a public who are gripped by fear of the unknown. Fears, concerns and beliefs are inherently normative characteristics, which cannot be simply overcome with quantitative evidence. Conversely, the significant amount of quantitative evidence gathered to provide a rational case for the OHL solution is irrelevant to NEPP, as their trust has already been lost.

The perception locally that EirGrid were approaching this from a narrow technocratic perspective and were determined to enforce their desired solution was continually reinforced by the failure to address local concerns. Supported by a number of expert reports, EirGrid firmly upheld OHL as the ‘best’ solution, and were (likely unintentionally) quite dismissive of NEPP concerns. As discussed in Section 2.2, the FAQ documents produced explicitly highlighted that potential health and environmental impacts are in line with ‘best practice’ and reference a number of reasons the public are misinformed. This attitude is perceived locally as indifference towards genuine local concerns and ensured that NEPP believe EirGrid have never given any meaningful consideration to the UGC alternative.

4 Discussion; Lessons for engineering education

“Traditional reductionist models of engineering education seek to extinguish context and uncertainty and reduce complexity across socio-economic and ecological domains. They therefore constitute a wholly inadequate response to the need for fit-for-purpose, twenty-first century graduates required to address broader sustainability issues.” (Byrne and Mullally, 2014)

The case study example highlighted in this paper has demonstrated how traditional engineering practices are inadequate in the face of contemporary challenges around critical energy infrastructure projects. To address this, modern curricula must include coursework that considers broader societal complexities, including so-called ‘wicked problems’. (Rittel and Webber, 1973) The wickedness of societal challenges such as energy and infrastructure projects means that they do not have a definitive

solution, contrary to the majority of engineering coursework that focuses on solving purely technical design challenges that can be reduced to a definitive mathematical understanding.

One means of achieving this integration into engineering education is through problem-based learning, including within coursework specific assignments that will expose students to broader social, environmental, ethical and political contexts. As was found to be the case by Byrne et al., most progress to date with EESD has been through '*strategically embedding case studies or flagship courses*'. (Byrne et al., 2010) Indeed, problem-based learning has been shown to be a valued means of developing professional skills (Beagon et al., 2019) and there are a number of recent examples highlighting its use in teaching 'socially responsible design'. (Bissett-Johnson and Radcliffe, 2019, Cote and Branzan Albu, 2019, Martin et al., 2019) However, renewals to curriculum of this manner can be a slow process over a number of decades. (Desha and Hargroves, 2012) Thus, they are inadequate in the face of pressing sustainability challenges such as climate change.

Addressing sustainability in this way means that it is just an interesting aspect of a student's education rather an ethos that is central to their engineering practice. (Mulder et al., 2013) More transformative examples of embedding sustainability may lie in degree programme, school or college-wide initiatives (Sheehan et al., 2012). The crosscutting nature of sustainability challenges make them a unifying issue that can effectively drive more meaningful educational innovation (Fourati-Jamoussi et al., 2018). Furthermore, an ethos change of this manner will require introducing multi/inter/trans-disciplinary learning, which will importantly expose students to the variety of disciplinary approaches and help broaden understanding of the diversity of worldviews that make up our society. At present multi/inter/trans-disciplinary practice is generally only introduced at a postgraduate level during research (Klaassen, 2018). This means it reaches a very limited amount of graduates, with those entering the workforce maintaining conventional disciplinary prejudice and bias. Earlier intervention during engineering education is essential if we are to build the necessary societal capacity for addressing sustainability challenges. (Byrne and Mullally, 2016) Multi/inter/trans-disciplinary practice facilitates a critical reflection on disciplinary approaches that can foster a greater level of respect for alternative perspectives.

5 Conclusion

Addressing contemporary sustainability challenges such as the growing threat of climate change, will require that engineers look beyond purely technical analysis, and instead seek to appreciate how different solutions may have a broader considerations when placed within our society. This is particularly apparent with regards to large-scale energy infrastructure projects that have generated widespread local opposition. As demonstrated in this case study example, the reductionist hubris that dominates engineer practice risks adding to public discontent, as local communities often poorly perceive it as arrogant and dismissive. Modern (fit-for-purpose) engineering curricula must include introductions to more holistic approaches as well as introducing multi/inter/trans-disciplinary practices. Engineers are necessarily technical experts and should remain so, but it is important to recognise our own inherent biases and respect the alternative perceptions our solutions will encounter when placed into an active society. Furthermore, in responding to contemporary sustainability challenges it is essential that engineers more critically reflect on their role within society, giving greater thought to how engineering design and practice may support or hinder progress towards ambitions such as a low carbon energy system.

6 References

- Aas, Ø., Qvenild, M., Wold, L. C., Jacobsen, G. B. and Ruud, A. 2017. 'Local opposition against high-voltage grids: public responses to agency-caused science-policy trolls', *Journal of Environmental Policy and Planning*, 19(4), pp. 347-359.
- ASKON Consulting Group 2008. *Comparative merits of underground cables and overhead lines as 400 kV transmission lines for the proposed North / South interconnector project*.
- Beagon, Ú., Niall, D. and Ní Fhloinn, E. 2019. 'Problem-based learning: student perceptions of its value in developing professional skills for engineering practice', *European Journal of Engineering Education*, 44(6), pp. 850-865.
- Bertsch, V., Hyland, M. and Mahony, M. 2017. 'What drives people's opinions of electricity infrastructure? Empirical evidence from Ireland', *Energy Policy*, 106, pp. 472-497.
- Bissett-Johnson, K. and Radcliffe, D. F. 2019. 'Engaging engineering students in socially responsible design using global projects', *European Journal of Engineering Education*, pp. 1-23.
- Byrne, E. P., Desha, C. J., Fitzpatrick, J. J. and Hargroves, K. (2010) 'Engineering education for sustainable development: a review of international progress'. International Symposium for Engineering Education.
- Byrne, E. P. and Mullally, G. 2014. 'Educating engineers to embrace complexity and context', *Proceedings of the Institution of Civil Engineers - Engineering Sustainability*
- Byrne, E. P. and Mullally, G. 2016. 'Seeing beyond silos: Transdisciplinary approaches to education as a means of addressing sustainability issues', *New Developments in Engineering Education for Sustainable Development*: Springer, pp. 23-34.
- Cote, M. and Branzan Albu, A. 2019. 'Teaching socio-cultural impacts of technology in advanced technical courses: a case study', *European Journal of Engineering Education*, 44(5), pp. 688-701.
- Department of Communications, Marine and Natural Resources, 2007. *Health Effects of Electromagnetic Fields*.
- Desha, C. and Hargroves, K. 2012. 'Engaging a multiple-track approach to building capacity for 21st Century engineering, opportunities and challenges for rapid curriculum renewal'. *Proceedings of the 8th International CDIO Conference*.
- Devine-Wright, P. and Batel, S. 2013. 'Explaining public preferences for high voltage pylon designs: An empirical study of perceived fit in a rural landscape', *Land Use Policy*, 31, pp. 640-649.
- Ecofys Germany GmbH 2008. *Study on the Comparative Merits of Overhead Electricity Transmission Lines Versus Underground Cables*.
- EirGrid plc 2007a. 'Cavan-Tyrone 400KV Power Line; Proposed Route Corridor Options, Public Consultation'.
- EirGrid plc 2007b. *North-South 400kV Interconnection Development Project Activity – 2007*.
- EirGrid plc 2007c. 'Press Release "North East to benefit from major electricity investment plans"'.
EirGrid plc 2009a. *Meath-Cavan and Cavan-Tyrone 400kV Power Line Projects; Community Update, April 2009*.
- Eirgrid plc 2009b. *Meath-Cavan and CavanTyrone 400 kV Power Lines; Progression to Phases Three and Four*.
- EirGrid plc 2009c. *North East 400kV Power Line Projects; Community Update, July 2009*.
- EirGrid plc 2009d. *North East Power Line Projects; Frequently Asked Questions July 2009*.
- EirGrid plc 2010a. *Circumstances Leading to Withdrawal of the Planning Application for Meath-Tyrone 400 kV Interconnection Development*.
- EirGrid plc 2010b. *North East Power Line Projects; Frequently Asked Questions January 2010*.
- Fourati-Jamoussi, F., Dubois, M. J., Agnès, M., Leroux, V. and Sauvé, L. (2018) 'Sustainable development as a driver for educational innovation in engineering school: the case of UniLaSalle', *European Journal of Engineering Education*, pp. 1-19.
- Freire, P. 1982. 'Creating alternative research methods: Learning to do it by doing it', *Creating knowledge: A monopoly*, pp. 29-37.
- Hussey, S. 2019. 'Supreme Court upholds permission for North-South Interconnector', *RTÉ news*. Available at: <https://www.rte.ie/news/courts/2019/0219/1031471-interconnector/>.

- Insight Statistical Consulting & Corr Consult 2016. *An Investigation into the Potential Relationship between Property Values and High Voltage Overhead Transmission Lines in Ireland*.
- KHSK Economic Consultants 2018. *International Practice in the Approach to and Levels of Compensation of Property Owners in Proximity to High-Voltage Transmission Lines*.
- Klaassen, R. G. 2018. 'Interdisciplinary education: a case study', *European journal of engineering education*, 43(6), pp. 842-859.
- Knudsen, J. K., Wold, L. C., Aas, Ø., Haug, J. J. K., Batel, S., Devine-Wright, P., Qvenild, M. and Jacobsen, G. B. 2015. 'Local perceptions of opportunities for engagement and procedural justice in electricity transmission grid projects in Norway and the UK', *Land Use Policy*, 48, pp. 299-308.
- Lienert, P., Sütterlin, B. and Siegrist, M. 2017. 'The influence of high-voltage power lines on the feelings evoked by different Swiss surroundings', *Energy Research & Social Science*, 23, pp. 46-59.
- Martin, D. A., Conlon, E. and Bowe, B. 2019. 'The role of role-play in student awareness of the social dimension of the engineering profession', *European Journal of Engineering Education*, pp. 1-24.
- Mulder, K., Desha, C. and Hargroves, K. C. 2013. 'Sustainable development as a meta-context for engineering education', *Journal of Sustainable Development of Energy, Water and Environment Systems*, 1(4), pp. 304-310.
- Normark, B., Belmans, R. and Bell, K. 2018. *Independent study to examine the technical feasibility and cost of undergrounding the North-South Interconnector*.
- Normark, B., Hoelsaeter, O.-H. and Belmans, R. 2012. *Meath-Tyrone Report; Review by the International Expert Commission*.
- North East Pylon Pressure 2008. *North East Pylon Pressure Campaign Information Leaflet*.
- North East Pylon Pressure 2009. *A Powerful Challenge*.
- North East Pylon Pressure 2014. 'ESRI Report highlights the urgency for EirGrid to underground the North-South Interconnector'.
- Parsons Brinckerhoff 2009. *Comparison of High Voltage Transmission Options; Alternating current overhead and underground, and direct current underground*.
- Parsons Brinckerhoff 2013. *Comparison of High Voltage Transmission Options; Alternating current overhead and underground, and direct current underground. Technology and costs update since 2009 report*.
- Rittel, H. W. and Webber, M. M. 1973. 'Dilemmas in a general theory of planning', *Policy sciences*, 4(2), pp. 155-169.
- RPS Planning & Environment 2009. 'Tyrone-Cavan Interconnector & Meath-Cavan Transmission Circuit; Corridor Evaluation Document'.
- Schmidt, P. and Lilliestam, J. 2015. 'Reducing or fostering public opposition? A critical reflection on the neutrality of pan-European cost-benefit analysis in electricity transmission planning', *Energy Research & Social Science*, 10, pp. 114-122.
- Sheehan, M., Schneider, P. and Desha, C. 2012. 'Implementing a systematic process for rapidly embedding sustainability within chemical engineering education: a case study of James Cook University, Australia', *Chemistry Education Research and Practice*, 13(2), pp. 112-119.
- Stadelmann-Steffen, I. 2019. 'Bad news is bad news: Information effects and citizens' socio-political acceptance of new technologies of electricity transmission', *Land use policy*, 81, pp. 531-545.
- Tempesta, T., Vecchiato, D. and Girardi, P. 2014. 'The landscape benefits of the burial of high voltage power lines: A study in rural areas of Italy', *Landscape and Urban Planning*, 126, pp. 53-64.
- Wadley, D. A., Han, J. H. and Elliott, P. G. 2019. 'Risk hidden in plain sight: Explaining homeowner perceptions of electricity transmission infrastructure', *Energy Policy*, 132, pp. 744-753.

10th Conference on Engineering Education for Sustainable Development (EESD2021)

Birr Community School – A Case Study in Retrofitting and Conserving Modern Architecture

John McLaughlin

Centre for Architectural Education, University College Cork, Douglas Street, Cork, Republic of Ireland

john.mclaughlin@ucc.ie

Abstract

More than half of the buildings in the world were built in the last hundred years, and the approach to construction of many of them assumed limitless fossil fuels. These buildings represent considerable embodied energy and, in some cases significant cultural and social value. As the limitations on planetary resources became more apparent in the last fifty years insulation began to be introduced into construction, and older buildings started to get basic retrofits. Much of the retrofit work done however damaged the cultural and aesthetic value of the architecture, and there is a need to balance the energy conservation imperative with the cultural value of older buildings. The President of the European Commission, Ursula van der Leyen, recognised this in her recent announcement of a “New European Bauhaus for a Green Transition” to address the need for a “renovation wave” that recognises the importance of sustainability in buildings and the cultural project of making “a bridge between the world of science and technology and the world of art and culture.”

This paper will present a case study in the architectural conservation of a nineteen seventies school building in Ireland that received funding under the Getty Foundation’s *Keeping it Modern* programme in 2018. The design of the school itself was a response to the changing society in Ireland of the nineteen seventies and represents a pivotal moment of transition in secondary education. The design was selected through a national architecture competition run by the Department of Education and the Royal Institute of Architects in Ireland (RIAI). The building was recognised by the award of a triennial God Medal from the RIAI and featured in the Pavilion of Ireland at the Venice Architecture Biennale in 2014, co-curated by the author. The school stands at the heart of the community in Birr town and many of the students are children of former students.

The research into the architectural conservation and renovation was developed in a subsequent project involving academics from UCC, UCD and QUB. The research methodology developed drew on Stewart Brand’s theory of “shearing layers” articulated in his book *How Buildings Learn* (1994). This research formed the basis of a conservation management plan that identified the social significance of the school and used social ethnographic methods to document this through drawings, photography, film, and interviews. An exhibition of this research was held at the Irish Architecture Archive in winter 2019-20. The Conservation Management Plan was finalised and submitted to the Getty Foundation in February 2021.

Introduction

The twentieth century saw exponential growth in the construction of new buildings and cities around the globe. Most of this production was based on an idea of limitless resources and economic growth. In Europe in particular, the destruction caused by World War Two left many cities flattened or badly damaged. In the period of transformation that followed the war the ongoing industrialisation of agriculture caused many people to migrate to cities where the new welfare state built mass housing on an industrial scale. The ongoing democratisation of education led to the construction of numerous schools and universities. The architecture of this age of the masses had been discussed and developed in intellectual circles like the Bauhaus and *Conférence Internationale pour l'Architecture Moderne* (CIAM) between the European wars and the model of an architecture based on the industrial scale production associated with factories was ready to be deployed. This architecture celebrated reinforced concrete as a structural material with large areas of steel-framed glazing bringing daylight to interior spaces.

Many modern buildings were designed and built at a time when there was no awareness of the limitations of natural resources and the rising temperatures caused by greenhouse gas emissions, and buildings were very poorly insulated. Additionally, many housing complexes became associated with the social problems caused by concentrations of poverty and were demolished around the turn of the century as acts of regeneration. In these acts no account was taken of the significant energy and resources embodied in these structures nor were they appreciated for the cultural and democratic social vision that they represented. This was the case in many countries and the negative attitude was deepened in France where the *grand-ensembles* housing projects of the nineteen sixties and seventies were populated by people from lower socio-economic groups, a large proportion of whom were African immigrants who were socially segregated to the *banlieues* (suburbs), and “the concrete towers represent a highly visible monument to the social plight of the suburbs and the failure of French integration policy.” (Ruby and Ruby 2007).

In the early 2000s, French architects Lacaton and Vassal carried out design research on the potential for refurbishment of these housing blocks for the Ministry of Culture and Communication. They published this work in 2007 in a book called *Plus – Les Grands Ensembles de Logements Territoire d'Exception* (More – Large Scale Housing Developments, An Exceptional Case) where they showed that it would be possible to retrofit and extend these housing developments so that every inhabitant could have fifty percent more living space for approximately half of the cost of demolishing and replacing them (Druot, Lacaton, and Vassal. 2007). Adopting the principle that “The most sustainable building is the one that you have already” they recommended that you never demolish, but rather add to and augment the architectural qualities of what you have already. The first of these projects was completed in Paris in 2012 and was recognised as a landmark in the development of architectural thinking, and a subsequent project in Bordeaux won the European Union Prize for Architecture in 2019.

In 2020 the President of the European Commission Ursula van der Leyen, announced in her state of the union speech a project for a “New European Bauhaus for a Green Transition” *to address the need for a “renovation wave” that recognises the importance of sustainability in buildings and the cultural project of making “a bridge between the world of science and technology and the world of art and culture”* (von der Leyen 2020).

The inclusion of culture in this announcement was very significant as it recognises the cultural value of architecture and the need to balance this with the desire to improve the energy performance buildings. In the twenty-first century modern architecture is seen as a significant cultural legacy of the twentieth century, and it is widely recognised that it needs to be preserved with its aesthetic qualities intact for future generations. Because of the nature of the industrial materials that were used in the construction of modern buildings this can lead to tensions between the desire to preserve cultural value on the one hand and the desire to improve environmental performance on the other. The description of the proposed new wave of renovation as a “cultural project” explicitly recognises this issue.

Making Ireland Modern

In 2014 the author and Professor Gary Boyd, then teaching colleagues in Queens University Belfast, were selected to represent Ireland at the Venice International Architecture Biennale which was addressing the theme “Absorbing Modernity” and asked participants to look back at the absorption of modern architecture in their countries over the previous century. We developed an exhibition titled *Infra-Eireann* that showed how in Ireland the newly independent modern state had used modern infrastructures to make Ireland modern after the dark night of colonialism. We researched and displayed ten “infrastructural episodes” corresponding to each decade of the century and we then went on to edit a book titled *Infrastructure and the Architectures of Modernity in Ireland 1916 – 2016* (Boyd and McLaughlin 2015). Following the Venice exhibition, the Arts Council of Ireland asked us to develop an expanded version of the exhibition as part of their 1916 commemoration programme of events and this exhibition titled “Making Ireland Modern” toured Cork, Dublin, and Galway, with a series of associated talks and events. The research project showed the strong relationship between modern architecture, infrastructure, and the social development of the Irish state. One of the key episodes was the democratisation of education that occurred in the nineteen seventies following the Free Education Act of 1967 which led to the construction of many schools and the expansion of universities. In the exhibition this was represented by St Brendan’s Community School in Birr, County Offaly which was built as a result of an architecture competition held in 1974 by the new Buildings Unit of the Department of Education, who were charged with the delivery of a major programme of school buildings.

Keeping it Modern

In 2014 The Getty Foundation in California launched a programme of grants called “Keeping it Modern” aimed at encouraging the conservation of Modern Architecture around the globe. The programme recognises that -

“Modern architecture is one of the defining artistic forms of the 20th century. Set free from traditional structural requirements, architects and engineers used experimental materials and novel construction techniques to create innovative forms and advance new philosophical approaches to architecture. Today this modern architectural heritage is at considerable risk. The cutting-edge building materials and structural systems that define the modern movement were often untested and have not always performed well over time. Heritage professionals do not always have enough scientific data on the nature and behaviour of these materials and systems to develop the necessary protocols for conservation treatment.”

In 2018 they invited the author and Professor Boyd to make an application for a grant to develop a Conservation Management Plan for a modern building in Ireland and we proposed Birr School. The school

is not only an important building, having won the triennial Gold Medal of the Royal Institute of Architects in Ireland (RIAI) in 1989, but is also representative of a whole generation of education buildings that were built in the nineteen seventies that are now badly in need of refurbishment and upgrade. We consulted the buildings unit of the Department of Education, who as the building's owners were supportive of our proposal and saw the value that this research could bring to a major section of their building stock. The school stands at the heart of the community in Birr town and is central to the social fabric of the town. The school owns a seventy-acre bog from which turf was harvested and burnt in the central heating plant up until 2001. Many of the students and some of the teachers are children of former students. Since part of the assessment of value in conservation of twentieth century architecture is the social significance of the building, we proposed using ethnographic survey methods developed in the social sciences alongside traditional hard science surveys to understand the building. The project team included the author, Professor Boyd of QUB, Aoibheann Ní Mhearain from UCD and Tara Kennedy from UCC, with QUB leading the study.



Methodology

The stage one research methodology brought together historical, fabric, social and environmental analysis to understand the school's daily performance, programmatically, socially, and environmentally, within the context of its architectural significance and its material vulnerabilities. Mapping and recording this broad

picture of the school was necessarily complex. It included archival research, oral histories, condition surveys and opening up work, considerable environmental data modelling and monitoring, and social surveys of behaviour and use. Typical classroom and breaktime spaces were monitored with temperature, relative humidity, and air quality monitors to understand the daily fluctuations in use. In addition, sound analysis, thermography, air pressure testing, and thermal bridge and condensation risk analysis help us understand the performance of the spaces. This layered approach surveys how the school is used, and also critically how the building is perceived by its users. The school had been recognised as an important building when it was first built and was featured in the British magazine *The Architect's Journal* with photographs by John Donat. One of the first surveys that we conducted was to commission another photographer, Ros Kavanagh, to take pictures from the same viewpoints as Donat had in 1980 and these pairs of images were featured in a commissioned article by the author and Aoibheann Ní Mhearáin in the international *Architectural Review* in June 2019. (McLaughlin and Ní Mhearáin 2019)) The photographs highlighted many of the changes that had been made to the building since its construction especially in 2001 when the building's services were upgraded, and the roof was replaced. Increased rainfall as a result of climate change had led to additional rainwater pipes and guttering being added which changed the appearance of the building.



Photographs of the school entrance by John Donat in 1979, and Ros Kavanagh in 2019.

Stage 2 'Interpretation' involved assimilating the range of information collated in Stage 1 'Understanding the Place' and beginning to gather meaning and findings from these. Where Stage 1 was about setting a baseline of information, Stage 2 is about developing meaning from the findings that can lead to outcomes in Stage 3. The aim of this process was to reveal otherwise unseen relationships in the school, to create connections between, usually separate, practices of social, historical, and environmental analysis. This is important in particular in this school because of the social and technological values that formed the basis for its design in the 1970s. This deepened understanding gained from this analysis informed the development of the statement of significance, policies, and intervention strategies in later stages.

The means of exploring connections between the 4 separate surveys of stage 1 was through interpretative and exploratory maps, including: A network map; a location map; chromomapping; social heat map; photography map; and environmental mapping. In most instances these maps use the spatial dimension of a map or plan, and connect it to interpretative information relating to time, networks, experience,

temperature etc. In this way the many layers of life of the building are made apparent, making connections between parts that are usually separate. In addition to the drawings a series of films by Ros Kavanagh were commissioned developing on the understanding of the building developed in stage one.

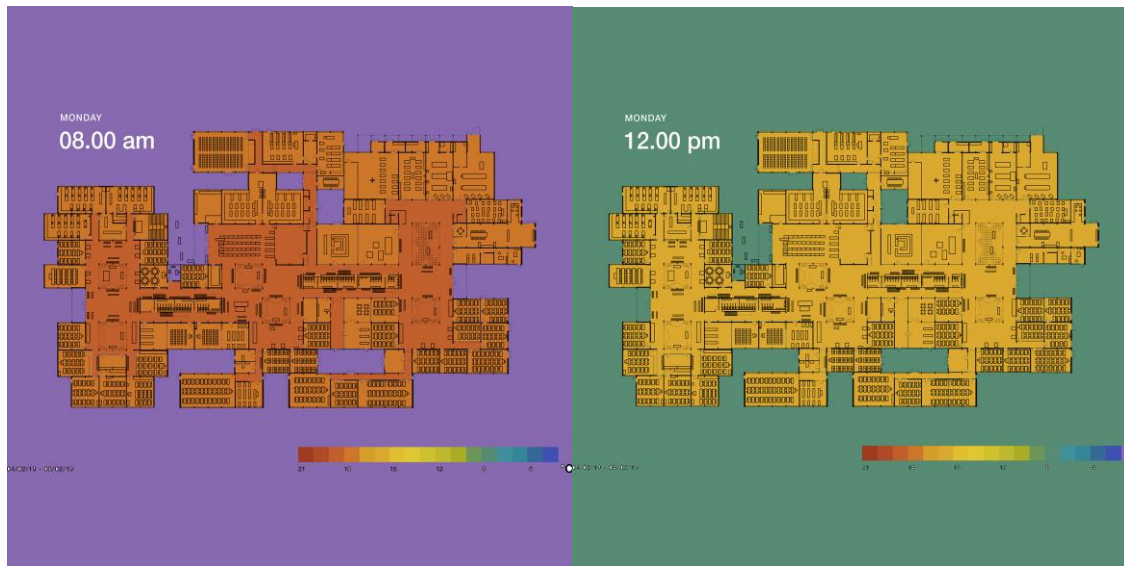

Spring Equinox Survey showing Temperature variations during a morning.

At the midpoint of the process, we organised a symposium on the conservation of modern architecture with a panel of international experts and we exhibited our research in an exhibition at the Irish Architectural Archive. This contributed to the dissemination to professional architects in Ireland of the emerging practice of conservation of modern architecture, and it provided us with a panel of mentors who gave us critical feedback on our proposed evaluation methods.

Evaluation

To isolate the elements of the building we used Stewart Brand's theory of shearing layers developed in his book *How Buildings Learn: What Happens After They are Built*, respectively: site, structure, skin, space plan, surfaces, services, and stuff (Brand, S. 1995). The shearing layers are represented in separate planimetric drawings and these planimetrics were used to show values. While shearing layers represent the physical layers, they also relate to the aspect of time in buildings, ranging from 'site' as the most enduring element of a building and 'stuff' being ephemeral, often changing daily. If we consider the elements of the building in relation to their longevity, this forms part of the consideration of their value. We added an eighth layer for "Society" to Brand's seven others to reflect a combined layer that represents the ethos of the project as it embraced social change in Irish life in the twentieth century, and continues to include the everyday social life of the school's staff and students. The term 'society' here relates to the original design intention as well as the socially historical significance; it also points the direction for the future of the school.

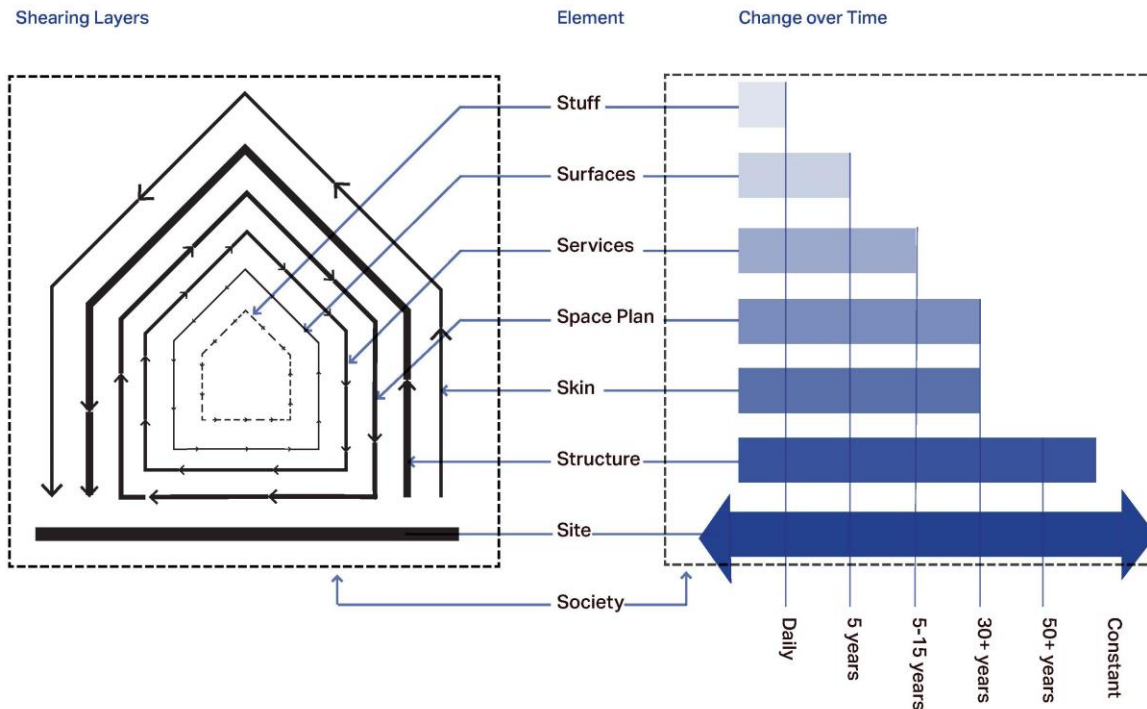

Significance

The school is an internationally recognised exemplar of post-war architectural modernism in Ireland and exhibits many of the hallmarks of this period. These include: the development of an innovative concrete portal frame system that provides a flexible and adaptable plan; technical detailing that expresses the means of construction and individual components; the use of off-the shelf, ordinary and inexpensive industrial materials; the qualities of transparency, created by the significant amount of glazing and the internal courtyards deep within the plan that blur the relationship between outside and inside. Intimately connecting the programme of the school with the structural system the plan realises a building that reflects the social agenda of the period, politically and architecturally. This is achieved through a sophisticated programming of teaching, social and courtyard spaces along with the concrete portal frame system that allows flexibility and variety. Together the social ambition and technical innovations create a democratic, non-hierarchical plan that accommodates a vibrant school. The school design was one of the premiated entries in the 1974 Department of Education school's competition, it is considered the most significant, successful, and progressive commission resulting from the competition. Significantly, it remains largely intact. The building received the RIAI's gold medal in 1989, the highest honour awarded by the institute, awarded 10 years after a building's construction.

Evaluation Matrix

While the statement of significance states *why* the building is important, the value matrix established *what* is important in the building. We examined, element by element, what was significant and located those in the building. Starting with the shearing layers as the core elements to be assessed, we ascribed values to these to create a value map for the building. Through more granular analysis we were then able to develop a matrix of the tolerance of the different layers for change along a scale of 1 to 5. This map in turn led us

to categorise vulnerabilities and opportunities for intervention within the building. On the basis of this assessment, we were able to develop a series of policies to guide future interventions into the building along with its ongoing expansion as a thriving school. Finally, from these policies, we drew up a series of strategies for intervention in the fabric to upgrade the environmental performance of the building while conserving its architecturally significant features.

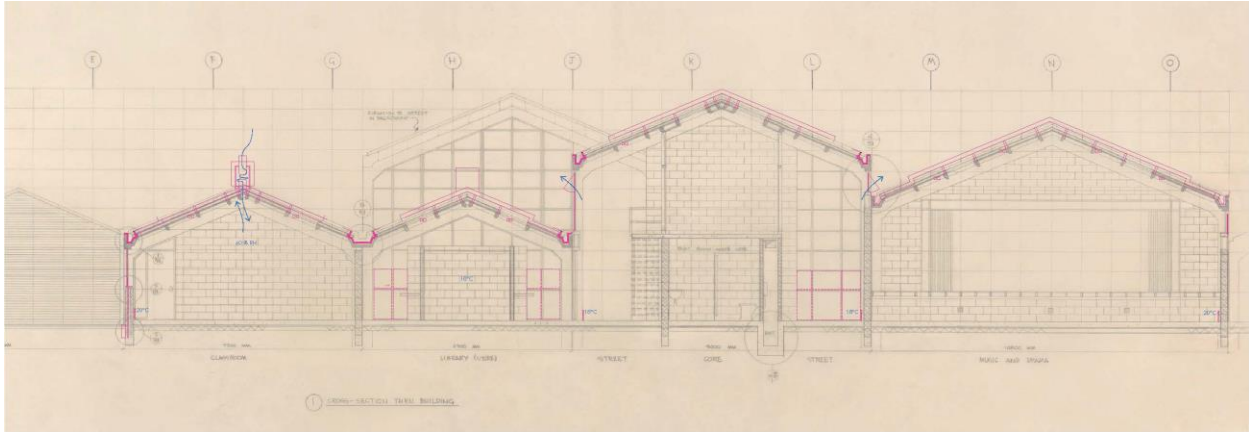

Archival section of Birr School overlaid with interventions highlighted in pink.

Impact

The first impact of this research has been on the school itself where our Conservation Management Plan (CMP) is guiding the development of proposals for refurbishment and expansion. Beyond that the research has already been exhibited in Ireland and has been the subject of articles in a number of international reviews. The Conservation Management Plan has only just been submitted to the Getty Foundation and it is hoped that our methodology will contribute to the developing discipline of retrofitting modern buildings which is expected to become a major part of architectural practice in the current century. The research methodology provides a model that will be used in the author's teaching of architectural design to students in the Cork Centre for Architectural Education as well as by the research partners in UCD and QUB.

References:

- Boyd, G. and McLaughlin, J. (eds) (2015). *Infrastructure and the Architectures of Modernity in Ireland 1916 – 2016*. Routledge.
- Brand, S. (1995) *How Buildings Learn: What Happens After They are Built*, Penguin (London), pp 12–23.
- Druot, F., Lacaton, A., and Vassal, J.P. (2007). *Plus- Les Grands Ensembles de Logements Territoire d'Exception*. Gustavo Gili Editions, Barcelona, Spain.
- McLaughlin, J. and Ní Mhearáin, A. (2019) *Revisit: Birr Community School, County Offaly, by Peter and Mary Doyle Architects*. *Architectural Review*, issue 1462, June 2019.
- Office of the President of the European Commission (2020); *A New European Bauhaus: op-ed article by Ursula von der Leyen, President of the European Commission*. Press Release 15th October 2020.
- Ruby, A., and I. (2007). *Reclaiming Modernism*, in Druot, F., Lacaton, A., and Vassal, J.P. (2007). *Plus- Les Grands Ensembles de Logements Territoire d'Exception*. Gustavo Gili Editions, Barcelona, Spain.

How Cognitive Development Affects Student Perception by Threading Sustainability through Civil and Environmental Engineering Curriculum

Jennifer S. Mueller¹

¹Civil and Environmental Engineering Department, Rose-Hulman Institute of Technology, Indiana, USA

muellerp@rose-hulman.edu

Abstract

As environmental, social, and economic systems grow in complexity, we need to fully understand the impacts that engineers and scientists have on the world around them. To better prepare students to understand the sustainability dimensions and tackle the challenges of real-world problems, a strategic approach has been implemented to incorporate sustainable design principles throughout the four-year undergraduate curriculum in civil and environmental engineering. To set a foundation of sustainability upon which students could build throughout their academic career, this approach involves intentionally threading sustainability concepts and applications through various courses in the required curriculum. During the first two years, an awareness of sustainable design is created in a required first-year introduction to design course, followed by higher-level learning of the science of sustainability and applying sustainability principles in a required sophomore-level course. The students are then prepared to address environmental, social, and economic impacts of projects in their civil engineering technical design courses during the third-year curriculum. In their fourth year, students apply sustainable design principles and develop sustainability metrics upon which to evaluate design solutions during their senior capstone design course.

With this approach, learning occurs not within a single course but across several courses spanning the four-year curriculum. The threads of learning approach allows faculty to incorporate sustainability into technical design courses, which provides students a more continuous exposure to understanding impacts of their design decisions and creating value in the broader, holistic perspective of engineering projects.

Assessment of student learning involved pre- and post-surveys at the beginning and end their four-year academic careers in the civil and environmental engineering curriculum. Students rated their opinions of the importance of various knowledge and skill sets to the engineering profession, as well as their confidence in addressing environmental, social, and economic aspects of engineering projects. This paper investigates how the cognitive development of incorporating sustainable design principles into engineering design problems as a thread of learning through the curriculum has affected students' perceptions of sustainability in their broader understanding of engineering professions.

1 Introduction

Sustainable development was coined by the Report of the World Commission on Environment and Development: Our Common Future in 1987 as “development that meets the needs of the present without compromising the ability of future generations to meet their own needs” (WCED, 1987). Since then the United Nations (UN) adopted 17 Sustainable Development Goals (SDGs) at the UN Sustainable

Development Summit in 2015 (UNGA, 2015). These SDGs, including issues related to poverty and hunger, availability of clean water and sanitation, sustainable cities and communities, and clean energy, are supported by the Division of Sustainable Development Goals within the UN. Key SDGs related to civil and environmental engineering include clean water and sanitation, sustainable cities and communities, life below water, and life on land, for example (UNGA, 2015). Additionally, the United States National Academy of Engineering (NAE) Grand Challenges for Engineering identified 14 goals for improving life in the 21st century. Some of these goals coincide with SDGs, including access to clean water, infrastructure, and economical sources of alternative energy (NAE, 2017).

In order to educate engineers in a way that instills confidence to tackle such complex and wicked challenges they may face in their career, it is important to include sustainable development as “just good engineering” (Sutter *et al.*, 2012) and as an integral component of their engineering education throughout the entire undergraduate curriculum.

2 Strategic Approach

To better prepare students to understand the sustainability dimensions and tackle the challenges of real-world problems, a strategic approach has been implemented to incorporate sustainable design principles as a thread of learning throughout the four-year undergraduate curriculum in civil and environmental engineering. During an introduction to design course taught in Year 1, students are introduced to sustainable design techniques to create an awareness of sustainability in engineering design. Through touch points of discussion in weekly lectures and through weekly reading assignments, students are exposed to the concept of the triple-bottom line and assessing social, economic, and environmental impacts of engineering design.

In Year 2, students take a required course in sustainable civil engineering. The first part of this course focuses on the science of sustainability, with coverage of biogeochemical cycles and global energy balance. The second part of the course emphasizes how to apply and measure sustainability in engineering design through life cycle assessments, systems thinking, resiliency, social impacts, sustainability indicators and metrics, and sustainability rating systems. Assessment of student learning showed improvement in students’ abilities to comprehend principles of sustainable design as set forth during Years 1 and 2 (Mueller and Robinson, 2015). For example, even in the initial years of incorporating sustainability into Years 1 and 2, students’ definitions of sustainable development grew from simplistic responses related to longevity and being “earth-friendly” to more substantive discussions of the triple bottom line, life-cycle thinking, and designs that are not only “beneficial for today’s generation, but for generations to come” (Robinson and Mueller, 2013).

In Year 3, sustainable design principles are reinforced in required technical civil and environmental engineering courses. For example, students in a structural mechanics course assess social, economic, and environmental impacts of a structural design problem. Students work on engineering designs related to urban stormwater management in a water resources engineering course and to nutrient removal in wastewater treatment in an environmental engineering course. Both are examples of design applications of global biogeochemical cycles discussed in CE250.

By Year 4, students are prepared to incorporate sustainable design principles in their capstone design projects and assess sustainability in their design by tracking performance indicators. A module on community engagement was also added in a required codes and regulations course in Year 4 that focuses on social sustainability through analysis of case studies from a variety of countries and cultures (Marincel Payne and Aidoo, 2017). As part of the concept development phase of senior capstone design, students are guided through a holistic approach to view the full perspective of their project to develop purpose and vision statements, as well as overall design objectives (Mueller, 2018). While working on their technical design components, students create sustainability metrics and performance indicators, such as area of land impacted by new trail alignment or area of social space in a building design, that they use as tools to measure sustainability in their design (Mueller and Robinson, 2015).

3 Results

Assessment of student learning involved pre- and post-surveys at the beginning and end their four-year academic careers in the civil and environmental engineering curriculum. The survey had two parts: rating confidence in personal ability to perform the stated tasks related to addressing sustainable development on an engineering design project and rating the level to which they agree or disagree to statements relating to the importance of sustainability in general and sustainable design in the engineering profession (McCormick *et al.*, 2015). These surveys were administered at the start of fall quarter, the beginning of the academic year for Year 1 students and at the end of spring quarter, the end of the academic year, for Year 4 students to assess cognitive development in sustainable design and affective development in sustainability over the four-year curriculum.

The first part of the survey involved statements in which students rated their degree of confidence to perform the tasks stated on a scale of 1-11 (1 = 0% confidence, 6 = 50% confidence, and 11= 100% confidence). The second part of the survey involved statements in which students rated the level to which they agreed or disagreed on a scale of 1-7 (1 = strongly disagree, 2 = disagree, 3 = slightly disagree, 4 = neutral, 5 = slightly agree, 6 = agree, 7 = strongly disagree).

Survey results were separated into responses from Year 1 students and responses from Year 4 students and were aggregated for three years of data collection: AY2016-17, AY2017-18, AY2018-19. The goal was to observe any changes in ability to achieve tasks related to sustainable design through the four-year curriculum on a general aggregate basis without longitudinally tracking each student cohort. The second goal was to observe any changes in perception of value and importance in sustainability and sustainable development.

Results from the first part of the survey show that mean ratings of confidence in achieving sustainable design tasks increased over the four-year curriculum (Table 1; Figure 1), with mean ratings showing around 50-60% confidence at the start of Year 1 to mean ratings showing around 80-90% confidence at the end of Year 4 for all tasks. This shows that students' perceived ability in achieving the tasks grew, which reflects on the cognitive development of learning the knowledge need to achieve said tasks. Results from the second part of the survey show that affective development did not follow cognitive development (Table 1; Figure 2). Mean ratings decreased slightly for all statements with ratings ranging from slight disagreement to agreement overall.

Table 1: Comparing responses from all Year 1 students with all Year 4 students for AY2016-17, 2017-18, and 2018-19. SD = standard deviation (survey questions from McCormick *et al.* 2015)

		Year 1 (n=71)		Year 4 (n=83)	
		Mean	SD	Mean	SD
Confidence in Ability: scale 1-11 (none – 100%)	Identify the environmental elements of an engineering project	6.06	2.41	9.06	1.47
	Understand environmental risks associated with engineering projects	6.38	2.39	8.95	1.48
	Identify the economic elements of an engineering project	6.31	2.38	9.25	1.32
	Understand the economic risks associated with engineering projects	6.30	2.33	9.22	1.34
	Identify the social elements of an engineering project	6.30	2.42	9.13	1.32
	Understand the social risks associated with engineering projects	6.10	2.34	9.10	1.39
	Recognize the social and economic impacts in engineering design	6.41	2.32	9.17	1.26
	Understand the interdependency among environmental, social, and economic aspects of engineering	6.34	2.29	9.33	1.33
	Assess the practicality of engineering design, including the potential impacts on community and economy	6.31	2.37	9.20	1.42
	Understand the meaning and application of sustainable engineering	6.21	2.44	9.24	1.39
Value Perception: scale 1-7 (strongly disagree - strongly agree)	It is important for me to learn how engineers can make the world more sustainable.	6.14	1.00	5.73	1.21
	Engineers play an important role in improving overall quality of life.	6.52	0.78	6.12	0.92
	The ability to assess social, economic, and environmental implications of engineering designs is a useful skill to help me be successful at my job.	6.23	0.95	5.63	1.25
	I would prefer to learn about sustainability engineering applications more than many other engineering concepts.	3.94	1.29	3.60	1.61
	I typically read news stories involving environmental, energy, and economic issues before reading other news stories.	4.18	1.59	3.83	1.78
	If income was not a factor, I would prefer a job related to sustainable development over other types of engineering positions.	3.83	1.65	3.41	1.73
	I have volunteered (or am planning to volunteer) on a project to help a community become more sustainable.	4.80	1.62	4.33	1.76
	I engage others in conversations and activities to heighten awareness of recycling, environmental protection, or sustainability principles.	3.99	1.70	3.80	1.60
	Practicing sustainability is a behavior that is a part of my everyday life.	4.68	1.49	4.49	1.43
	My future career will likely involve solving local or global problems that may involve social, economic, and environmental issues.	5.32	1.58	5.13	1.44

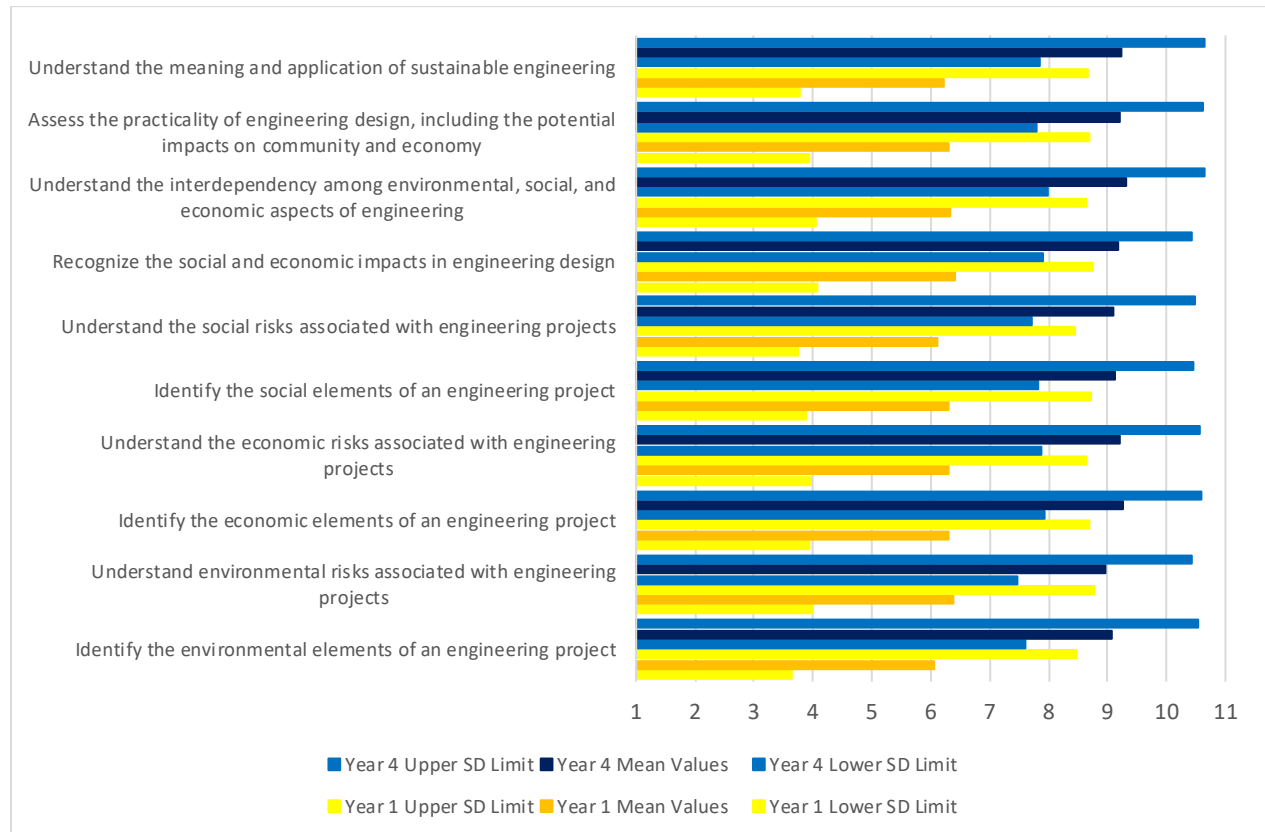

Figure 1: Ratings on a scale of 1 (not confident) to 11 (fully confident) of confidence in abilities related to addressing sustainable design on an engineering project from AY2016-17, 2017-18, and 2018-19; SD = standard deviation; Year 1 n=71, Year 4 n=83 (survey questions from McCormick *et al.* 2015)

Other questions were investigated, including if there was a trend over the three years when just comparing student responses at the start of Year 1 for the three years of data and separately comparing student responses at the end of Year 4 for the three years of data. The purpose of this was to check for general trends in student perception over the three years that would not be attributed to the strategic approach of incorporating sustainable development in the four-year curriculum. No trends were observed when comparing responses from Year 1 students through AY2016-17, 2017-18, and 2018-19. Similarly, no trends were observed when comparing responses from Year 4 students through AY2016-17, 2017-18, and 2018-19. Upon completion of Year 4 students at the end of AY2019-2020, results can be compared longitudinally for a single cohort from the start of Year 1 to the end of Year 4.

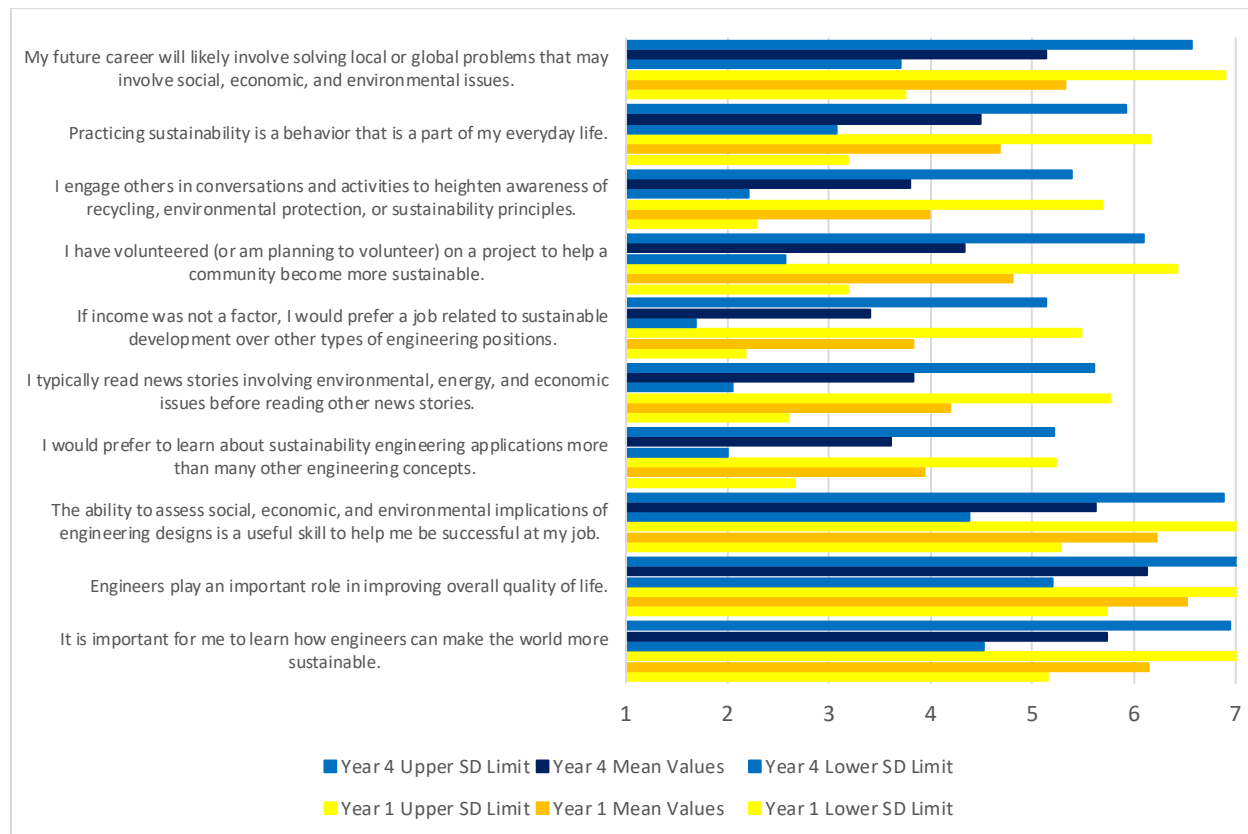

Figure 2: Ratings on a scale of 1 (strongly disagree) to 7 (strongly agree) of value perceived in sustainability and sustainable design from AY2016-17, 2017-18, and 2018-19; SD = standard deviation; Year 1 n=71, Year 4 n=83 (survey questions from McCormick *et al.* 2015)

4 Conclusion

Through the threads of learning approach, learning occurs not within a single course but across several courses spanning the four-year curriculum. This allows faculty to incorporate sustainability in the context of technical designs, which provides students a more continuous exposure to understanding impacts of their design decisions and creating value in the broader, holistic perspective of engineering projects. By not solely addressing sustainable design in a single, self-contained course, students also experience applications of sustainable design integrated into several courses to emphasize the perspective that addressing sustainability is just part of the engineering design process and not an ancillary topic.

Although perception of importance or value in sustainability did not increase, the confidence in ability to achieve tasks related to assessing and incorporating sustainable design in engineering projects increased from the start to the completion of the four-year civil and environmental engineering undergraduate curriculum. This study showed that cognitive development did not directly lead to affective development, in general. Future studies will longitudinally track a single cohort of students to compare responses at the beginning and end of their undergraduate academic career to yield more deterministic results of following

the same group of individuals, as opposed to investigating different sample sets of students from the same population.

5 References

- Marincel Payne, M., & Aidoo, J. 2017. Strengthening Sustainable Design Principles in the Civil Engineering Curriculum. In *Proceedings of 2017 American Society for Engineering Education Annual Conference & Exposition*, Columbus, Ohio.
- McCormick, M. Bielefeldt, A.R., Swan, C.W., & Paterson, K.G. 2015. Assessing students' motivation to engage in sustainable engineering. *International Journal of Sustainability in Higher Education* 16(2): 136-154. DOI 10.1108/IJSHE-06-2013-0054.
- Mueller, J. 2018. Incorporating a Holistic Approach to Senior Capstone Design. In *Proceedings of Engineering Education for Sustainable Development*, Glassboro, NJ.
- Mueller, J., & Robinson, M. 2015. Developing Future Engineers through Sustainable Design in Undergraduate Civil Engineering Curriculum. *ASCE Journal of Water Resources Planning and Management: Special Issue on Sustainability*. DOI: 10.1061/(ASCE)WR.1943-5452.0000505.
- National Academy of Engineering (NAE). 2017. *Grand Challenges for Engineering*. Washington, DC.
- Robinson, M., & Mueller, J. 2013. Integrating Sustainable Design into Undergraduate Civil Engineering Curriculum. In *Proceedings of 2013 World Environmental & Water Resources Congress*, American Society of Civil Engineers – Environmental & Water Resources Institute, May 19-23.
- Sutterer, K., Mueller, J., & Robinson, M. 2012. It's just good engineering—One case of curricular evolution of sustainable design. In *Proceedings of 2012 American Society for Engineering Education Annual Conference & Exposition*, San Antonio, Texas.
- United Nations General Assembly (UNGA). 2015. *Transforming our world: the 2030 Agenda for Sustainable Development*. A/RES/70/1.
- World Commission on Environment and Development (WCED). 1987. *Our common future*. United Nations. Oxford University Press, Oxford, U.K.

Education for Sustainability: Rethinking Digital Teaching and Learning Strategy

Dr Morag Munro

Office of the Dean of Teaching and Learning, Maynooth University, Republic of Ireland

morag.munro@mu.ie

Abstract

In this paper I argue that National strategy relating to digital learning and teaching in Higher Education (HE) both foregrounds technology as a means to advance a neoliberal policy agenda, and neglects HE's pivotal role in equipping graduates to deal with global sustainability challenges. I argue for an alternative framing of digital teaching and learning in policy discourse that, rather than being underpinned by neoliberal ideology, aims to prepare graduates to contribute to a more sustainable global society.

Neoliberalism, a worldview that puts faith in the supremacy of the free market at the heart of all human activities, has become the prevailing ideology determining the purpose and operation of HE systems worldwide. HE tends to be presented in policy and strategy discourse as being primarily concerned with enhancing economic growth and global competitiveness, and with advancing the wealth and social mobility of the individual. Given the increasing influence of neoliberalism on HE, it is perhaps unsurprising that we see evidence of neoliberalism's influence in digital teaching and learning strategy. In order to demonstrate this in detail, I will draw on some of the findings of a Critical Discourse Analysis (CDA) of 13 UK digital teaching and learning strategies. Across the strategies the need to grow the economy and to upskill citizens accordingly is presented as one of the main drivers for implementing digital learning and teaching in HE. As well as primarily framing digital learning and teaching as a means to advance the neoliberal agenda, the strategies also fail to reference the role that digital technologies might play in supporting pedagogical strategies aimed at developing the attributes that students will need to address sustainability challenges. I will conclude by referring to some examples of good practice in the use of digital technologies to support sustainability education, and by making some recommendations for future policy and strategy directions.

1 Introduction

Higher Education (HE) has an essential role to play in promoting sustainable global development, and in equipping graduates to deal with environmental and resourcing challenges (Shephard 2015). In this paper, I argue that National strategies relating to digital learning and teaching in HE frame technology as a means to advance a neoliberal policy agenda that elevates economic success above all other priorities. In addition, such strategies fail to consider the role that digital technologies might play in equipping graduates to address global sustainability issues. In order to demonstrate this in detail, I draw on some of the findings of a Critical Discourse Analysis (CDA) of 13 UK digital teaching and learning strategies spanning the time frame 2003–2013, and amounting to a corpus of approximately 138, 900 words (Munro, 2016). Across the strategies advancing economic growth is promoted as a key priority for HE, with the need to compete in the knowledge economy and to upskill citizens accordingly repeatedly presented as key drivers for implementing digital learning in HE. Digital learning is also frequently framed as a way to facilitate wider

and lifelong participation in HE, and although the social benefits of the aforesaid are sometimes referred to, these are eclipsed by a focus on their claimed economic purpose. As well as framing digital learning and teaching as a means to advance the neoliberal agenda, the strategies also fail to reference the role that digital technologies might play in supporting pedagogical strategies aimed at developing the attributes that students will need to address sustainability challenges. I argue for an alternative framing of digital teaching and learning in policy discourse that, rather than being underpinned by neoliberal ideology, aims to prepare graduates to contribute to the development of a more sustainable global society.

2 Neoliberalism, Higher Education and Sustainability

Four suppositions lie at the heart of neoliberal ideology: 1. The self-interested individual - Individuals are self-interested and rational economic actors; 2. Free market economics - The market is the most efficient mechanism for allocating resources and opportunities; 3. Laissez-faire - Markets are self-regulating, hence state power and intervention in their operation should be minimised; and 4. Free trade - Global free trade and open economies are prerequisites for economic growth (Olssen & Peters, 2005). Neoliberal orthodoxy has grown exponentially from its roots as a peripheral economic theory and has proliferated into a global political and economic hegemony (Harvey, 2005). Critics of the neoliberal thesis point out that neoliberalism rests on at best, questionable, and at worst, entirely flawed, prepositions. The untrammelled market was heralded by its forefathers as a failsafe method for achieving capital growth and accumulation; yet overall growth rates have declined under neoliberal regimens (Harvey, 2005). Advocates allege that the application of neoliberal principles will achieve a better standard of life for all; neoliberal policies have instead primarily benefited the already privileged, and the gap between the poorest and the richest has grown (Harvey, 2005). Furthermore, the elevation of economic success over all other priorities is contributing to the destruction of the physical environment and is squandering scarce physical resources (Foster *et al.* 2011) as well as hindering attempts at sustainable development (Kumi *et al.* 2014).

HE systems worldwide are increasingly organised around neoliberal principles. Proponents of neoliberalism assert that market-based competition and economically focused priorities result in Universities becoming more efficient, innovative and entrepreneurial; leads to a higher quality of research activity and education provision; generates better diversity of provision; and results in a better alignment between HE's 'outputs' (research and graduates) and the needs of the economy and society. Under successive neoliberal regimes, however, there has been a marked shift from a combination of social, cultural, and economic goals for HE towards an almost exclusively utilitarian purpose. HE's function now tends to be presented in policy and strategy, and indeed across much contemporary discourse, as being primarily concerned with enhancing economic growth and global competitiveness, and with advancing the wealth and social mobility of the individual. Yet HE has an essential role to play in equipping graduates with the skills and competencies required for sustainable and responsible living in an increasingly fragile physical environment (Shephard 2015); a narrow instrumental and individualistic focus on the role of HE risks sidelining these important issues.

3 Neoliberalism and Digital Learning and Teaching Strategies

Given the increasing influence of neoliberalism on HE, coupled with neoliberalism's wholesale embrace of ICTs, the "privileged technology of neoliberalism" (Harvey, 2005, p.159), it is unsurprising that we see evidence of neoliberalism's influence in digital learning strategies (Hayes, 2016; Roumell & Salajan, 2016). Across the 13 strategies analysed, a key motivation for digital teaching and learning is as a means to advance economic growth. Although digital technologies are portrayed as a way to enable lifelong and wider participation in HE, the primary objective again seems to be to advance economic competitiveness. For example:

[E]ffective application of technology in learning can help underpin the knowledge based economy in Wales, and drive its growth. (ELWa, 2003, p.12)

[Digital teaching and learning] can contribute to all the Government's objectives for education – to raising standards; improving quality; removing barriers to learning and participation in learning; preparing for employment; upskilling in the workplace. (DfES 2003, p.4)

[Digital Learning is] ideal for helping learners develop the skills they need for the knowledge-based economy. (DfES, 2005, p.27)

We recognise the role technology-enhanced learning may play in ensuring that HEIs in Wales maintain competitiveness in the global marketplace and contribute to the knowledge economy". (HEFCW, 2008, p.2)

While it is certainly important that HE remains relevant to the economy, framing a country's advancement solely in economic terms disregards other essential aspects of societal welfare and environmental concern. Economic growth does not necessarily equate to a better quality of life: levels of education, health, and employment are all poorly correlated with growth (Drudy 2009; Nussbaum 2010). Additionally, while a country may be performing economically well overall, it does not mean that there is a fair distribution of income (Drudy, 2009). Focusing only on economic performance also neglects the impacts of the unfettered pursuit of growth on resource depletion and environmental degradation (Kubiszewski *et al.*, 2013).

For Keep (2011, p.25) "what is excluded [from policy and strategy] is usually every bit as important as what is included". It is therefore notable that, with the exception of the two perfunctory references below, across the 138 900-word corpus no reference is made to the role that HE might play in relation to addressing issues of climate change and sustainability:

You may also wish to consider the role of technology in relation to other issues, including: [...] Education for Sustainable Development and Global Citizenship. (HEFCW, 2008, p.11)

Becta will develop approaches to technology infrastructure that encourage architectures which use less power and allow users to make better use of devices and technology which negate the need for energy consumption in other ways, such as remote working. (Becta, 2008, p.40)

These findings are not exclusive to the UK: similar patterns are evident in national digital learning strategies worldwide. In their review of EU digital teaching and learning policy, Salajan and Roumell (2015) note clear linkages between the stated aims of the strategies and aspirations to enhance the EU's economic competitiveness. In their review of global digital teaching and learning strategies, Brown *et al.* (2007, p.80) found that "a strong economic imperative is common to many e-learning policy initiatives". Referring to their content analysis of the USA's four National Education Technology Plan (NETP) documents, Roumell & Salajan (2016, p. 365) highlight that "endemic tensions within the NETP discourse become apparent in

the competing visions of education as a means of both conferring economic fluency and mobility to individuals within the society”.

The relationship between policy and practice is complex, and there is frequently a disconnect between education strategy as it is articulated, and its application and outcomes (Coffield *et al.* 2008); thus it is difficult to determine the extent to which the policies considered have impacted on HE. What is certain, however, is that the strategies send out a clear message regarding the policy-makers’ perceptions about the purpose of HE, and the role that digital learning should play in achieving the same. Moreover, the UK strategies analysed framed several funding opportunities for the exploration of the use of technology in HE in the UK, with such programmes claimed to have had lasting impacts (Jisc & Million+, 2009). It is also clear that, despite the rhetoric surrounding the claimed transformative potential of digital technologies, their deployment in HE has been rather more banal. Digital technologies have mainly been used to support rather than to transform practice, often replicating face-to-face teaching strategies, automating administrative tasks, or promoting, content-driven pedagogical models (Kirkwood & Price, 2014; Walker *et al.*, 2016). With this in mind, it is worth exploring what digital learning might look like if the strategy for its implementation was framed by an alternative vision for HE, one that aspires to prepare graduates to contribute to the development of a more sustainable global society. In order to do this, in what follows I discuss some examples of good practice that demonstrate how the judicious application of digital technology to learning and teaching might support education for sustainability.

4 Education for Sustainability: The Role of Digital Technologies

The skills and attributes that graduates will require to address issues of global sustainability and climate change include the capacity to communicate with, and empathise with those of different cultures and beliefs, as well as an ability to think critically and ethically about the global issues facing humankind as a ‘citizen of the world’ (Nussbaum 2010; Raphael *et al.* 2010; UNESCO 2014). Digitally mediated approaches that could support students to develop these capacities include telecollaboration, digital storytelling, and role-playing games and simulations.

Intercultural competence, the ability to effectively communicate and collaborate with those who are culturally different from oneself, is crucial if citizens are to work collectively towards addressing global concerns (Deardorff 2009). Cultivating understanding and empathy with others is essential to engendering intercultural competence (Nussbaum 2010). But it can be difficult for people to identify with those who are socially or culturally different, or who are geographically distant (Bachen *et al.* 2012). Telecollaboration involves enabling geographically dispersed learners to engage in dialogue and intercultural exchange. This is not a new concept: technology supported tandem learning, an approach that pairs learners with complementary target and native languages in bilingual/bicultural exchanges, has been employed in language teaching for over two decades (Sasaki 2015). More recently, there has been some limited exploration of the extension of online intercultural exchange supporting the development of intercultural competence beyond language learning, via online discussion forum exchanges (Benabdallah 2016); using audio-visual communication (Kirby & Amendolara 2016); in virtual worlds (Canto *et al.* 2013); and via online games (Thorne 2008).

Another relatively under-explored digitally mediated mechanism through which intercultural awareness and understanding might be fostered is digital storytelling, an approach with roots in social justice education

(Lambert 2012). The multimodal nature of digital stories can support students to share their lived experiences in a richer and more dynamic way than is possible via written communication alone. Digital storytelling can also be a powerful mechanism for engaging young people in learning about, and reflecting on, the local contexts that are both affected by, and contribute to, global issues such as the environment and climate change (Truong-White & McLean 2015).

Role-play can be an effective way to help individuals to cultivate empathy with those who differ from them in circumstances or viewpoint (Nussbaum 2010). Role-play enabled via electronic games, simulations, and virtual worlds may be particularly suited to fostering empathy, since such media can enable participants to become immersed in the roles and perspectives of others within authentic and multimodal environments (Raphael *et al.* 2010). A good example is the Real Lives game, which allows players to ‘inhabit’ the lives of people around the world including their experiences of education, employment, relationships, family, disease, natural disasters etc. Bachen *et al.* (2012) found that students who played the game expressed greater global empathy and demonstrated more interest in learning about other cultures.

Digital Games and simulations can also help to foster the systematic and critical thinking necessary for sustainable development, since they can allow students to access institutional, geographical, and temporal settings that it would not otherwise be possible to explore or experience (Bachen *et al.* 2015). Well-crafted games and simulations can also support the development of the leadership skills and collective action required to address real-world problems (Raphael *et al.* 2010). Digital games can also challenge participants to consider multiple perspectives on contested events or ideas, either during the game, or in post-game class discussions (Bachen *et al.* 2015). Well-designed games and simulations can also support the development of the critical and ethical reasoning ability required to address sustainability issues, due to the immersive opportunities that they might generate for students to experience and reflect on ethical dilemmas and to explore the consequences of their choices (Schrier & Gibson 2010). For example, in order to ‘succeed’ in the Macdonald’s Game players must maximise profits by clearing rainforests, mistreating animals, violating workers’ rights, engaging in poor food safety practices, and partaking in questionable political lobbying. It can also be difficult for individuals to see themselves as part of the bigger picture, or for them to see how their actions can influence these global issues (Blake 1999). Games and simulations have shown some potential to support students to learn about, as well as to generate local and global actions in relation to these crucial issues. For example, Nilsson & Jakobsson (2011) used SimCity to support students to explore models of future sustainable cities. World Without Oil is another excellent example of the type of game that could help students to ground learning about global sustainability issues within their own local contexts, and in demonstrating that individual and local actions towards change are attainable and can have global impact. The online multi-player game simulated the first 32 weeks of a global oil crisis, and was played by over 1900 people worldwide over a 3-week period. Participants collaborated to work out strategies to survive in a world without oil (Rusnak *et al.* 2008). Another interesting example is Shortfall Online. Teams of players learn to manage simulated companies within the automobile supply chain, and make decisions based on trade-offs between economic, environmental, and social impacts (Gennett 2010).

5 Policy Implications

As the examples above illustrate, if digital learning strategies were to be motivated by an alternative set of assumptions about the role of HE, then manifestations of digital learning could look quite different. At the

time of writing the European Commission (EC) has recently published the Digital Education Plan 2021-2027: Resetting education and training for the digital age (EC, 2020). It is significant that this document makes reference to the role of education in sustainable development:

Education and training are key for personal fulfilment, social cohesion, economic growth and innovation. They are also a critical building block for a fairer and more sustainable Europe. (EC, 2020, p.2).

Digital skills are also identified as having a role to play in sustainable development:

A changing society and the transition to a green and digital economy require solid digital competences. Boosting digital skills at all levels helps increase growth and innovation and build a fairer, more cohesive, sustainable and inclusive society. (EC, 2020, p.12).

While this shift in emphasis is certainly a step in the right direction, there is a risk that the 'Green agenda' becomes a smokescreen for the continued unfettered pursuit of economic growth at the expense of sustainability priorities, with digital teaching and learning remaining complicit in the same. Instead, there is a need for future HE policy, in general, and digital teaching and learning strategy in particular, to clearly set out the skills and attributes that our graduates will require to address issues of global sustainability and climate change, and then to consider the role that technology might play with respect to the same.

References

- Bachen, C., Hernández-Ramos, P., & Raphael, C. 2012. Simulating REAL LIVES: Promoting global empathy and interest in learning through simulation games. *Simulation & Gaming*, **43**(4), 437-460.
- Bachen, C., Hernández-Ramos, P., Raphael, C., & Waldron, A. 2015. Civic play and civic gaps: Can life simulation games advance educational equity? *Journal of Information Technology & Politics*, **12**(4), 378-395.
- Becta. 2008. *Harnessing technology: Next generation learning*. Becta, on behalf of the Department for Children, Schools and Families & The Department for Innovation, Universities and Skills
- Blake, J. 1999. "Overcoming the 'value-action gap' in environmental policy: Tensions between national policy and local experience", *Local Environment*, **4**(3), 257-278.
- Brown, M., Anderson, B., & Murray, F. 2007. E-learning policy issues: Global trends, themes and tensions. *Proceedings of Ascilite 2007: ICT: Providing choices for learners and learning* (pp.75-81).
- Canto, S., Jauregi, K. & van den Bergh, H. 2013. "Integrating cross-cultural interaction through video-communication and virtual worlds in foreign language teaching programs: is there an added value?" *ReCALL*, **25**(1),105-121.
- Coffield, F., Edward, S., Finlay, I., Hodgson, A., Spours, K. and Steer, R. (2008). *Improving learning, skills and inclusion: The impact of policy on post-compulsory education*, London: Routledge.
- Deardorff, D.K. 2009. *The SAGE handbook of intercultural competence*, SAGE, London.
- DfES 2003d. *Towards a Unified e-learning Strategy. Consultation Document*, Department for Education and Skills (DfES).

- DfES. 2005. Harnessing technology: Transforming learning and children's services. Department for Education and Skills (DfES).
- Drudy, P. 2009. Problems with economic growth: Towards a better measure of progress? In B. Reynolds, & S. Healy (Eds.), *Beyond GDP: What is prosperity and how should it be measured?* (pp. 1-14). Social Justice Ireland.
- ELWa. 2003. An e-learning strategy for wales. National Council of Education and Training for Wales
- European Commission. 2020. Digital Education Plan 2021-2027: Resetting education and training for the digital age. https://ec.europa.eu/education/education-in-the-eu/digital-education-action-plan_en
- Foster, J. B., Clark, B., & York, R. 2011. *The ecological rift: Capitalism's war on the earth*. Monthly Review Press.
- Gennett, Z. A. 2010. Shortfall online: The development of an educational computer game for teaching sustainable engineering to millennial generation students. (Unpublished master's thesis). North Eastern University, Boston.
- Harvey, D. 2005. *A brief history of neoliberalism*. Oxford University Press.
- Hayes, S. 2016. Learning from a deceptively spacious policy discourse. In: T. Ryberg, C. Sinclair, S. Bayne, M. de Laat. (Eds.), *Research, Boundaries, and Policy in Networked Learning*. Research in Networked Learning (pp. 23-40). Springer.
- Jisc and Million+. 2009. From inputs to impact. A study of the impact of JISC funding on universities. <http://www.jisc.ac.uk/publications/documents/millionplusfundingimpact.aspx>
- Keep, E. 2011. The English skills policy narrative. In A. Hodgson, K. Spours & M. Waring (Eds.), *Post-compulsory education and lifelong learning across the United Kingdom. Policy, organisation and governance* (pp. 18-38). Institute of Education, University of London.
- Kirby, V. & Amendolara, S. 2016. "Intercultural Encounters through Video Conferencing", Paper presented at: The Second International Conference on Telecollaboration in Higher Education, Trinity College, Dublin, 21-23 April.
- Kirkwood, A., & Price, L. 2014. Technology-enhanced learning and teaching in higher education: What is 'enhanced' and how do we know? A critical literature review. *Learning, Media and Technology*, **39**(1), 6-36.
- Kubiszewski, I., Costanza, R., Franco, C., Lawn, P., Talberth, J., Jackson, T., & Aylmer, C. 2013. Beyond GDP: Measuring and achieving global genuine progress. *Ecological Economics*, **93**, 57-68.
- Kumi, E., Arhin, A.A. & Yeboah, T. 2014. "Can post-2015 sustainable development goals survive neoliberalism? A critical examination of the sustainable development–neoliberalism nexus in developing countries", *Environment, Development and Sustainability*, **16**(3), 539-554.
- Lambert, J. 2012. *Digital storytelling: Capturing lives, creating community*, Routledge.
- Munro, M. 2016. *A Decade of E-Learning Policy in Higher Education in the United Kingdom: A Critical Analysis*. (Unpublished doctoral dissertation). University of Glasgow, Glasgow

- Nilsson, E. M., & Jakobsson, A. (2011). Simulated sustainable societies: Students' reflections on creating future cities in computer games. *Journal of Science Education and Technology*, **20**(1), 33-50.
- Nussbaum, M. C. 2010. *Not for profit: Why democracy needs the humanities*. Princeton University Press.
- Olssen, M., & Peters, M. 2005. Neoliberalism, higher education and the knowledge economy: From the free market to knowledge capitalism. *Journal of Education Policy*, **20**(3), 313-345.
- Raphael, C., Bachen, C., Lynn, K., Baldwin-Philippi, J. & McKee, K.A. 2010. "Games for civic learning: A conceptual framework and agenda for research and design", *Games and Culture*, **5**(2), 199-235.
- Roumell, E. A., & Salajan, F. D. 2016. The Evolution of U.S. e-Learning Policy: A Content Analysis of the National Education Technology Plans. *Educational Policy*, **30**(2), 365–397.
- Rusnak, P., Dobson, T., & Boskic, N. 2008. Articulation of ecological values in alternate reality gaming: A case study of world without oil. *Proceedings of the 2nd European Conference on Games Based Learning* (pp. 383-392).
- Salajan, F. D. and Roumell, E. A. 2016. Two Decades of E-Learning Policy Evolution at EU Level. *European Journal of Education*, **51**, 391-407.
- Sasaki, A. 2015. "E-mail Tandem Language Learning" in *Language Learning Beyond the Classroom*, eds. D. Nunan & J.C. Richards, Routledge, pp. 115-125.
- Schrier, K. & Gibson, D. 2010. *Ethics and Game Design: Teaching Values through Play: Teaching Values through Play*, IGI Global.
- Shephard, K. 2015. *Higher Education for Sustainable Development*, Palgrave Macmillan.
- Thorne, S.L. 2008. "Transcultural communication in open Internet environments and massively multiplayer online games" in *Mediating Discourse Online*, ed. S.M. Pierce, John Benjamins Publishing Company, pp. 305-327.
- Truong-White, H., & McLean, L. 2015. Digital storytelling for transformative global citizenship education. *Canadian Journal of Education*, **38**(2), 1.
- UNESCO. 2014. *Global citizenship education: Preparing learners for the challenges of the twenty-first century*. Paris: United Nations Educational, Scientific and Cultural Organization (UNESCO) <https://www.gcedclearinghouse.org/resources/global-citizenship-education-preparing-learners-challenges-21st-century>
- Walker, R., Voce, J., Swift, E., Ahmed, J., Jenkins, M., & Vincent, P. 2016. *UCISA report: 2016 survey of technology enhanced learning for higher education in UK*. Universities and Colleges Information Systems Association (UCISA). <https://www.ucisa.ac.uk/tel>

Designing Laboratory Experiments for Electricity Grid Integration of Renewable Energy using Microgrid, Test-Rig Emulators and Real Time Simulation Tools

Donal B. Murray¹, Nuh Erdogan¹, Alparslan Zehir¹ and Barry P. Hayes²

¹Marine and Renewable Energy Centre, University College Cork, Cork, Ireland

²School of Engineering, University College Cork, Cork, Ireland

donalbmurray@ucc.ie, nuh.erdogan@ucc.ie, alparslan.zehir@ucc.ie, barry.hayes@ucc.ie

Abstract

This paper describes efforts to integrate advanced approaches in microgrid, test-rig emulators and real time simulation into early postgraduate and undergraduate engineering education. It describes two experiments designed for groups of early stage researchers and postgraduate students in the field of Offshore Renewable Energy (ORE). These electrical laboratory experiments are part of a H2020-funded weeklong training course and focus on a medium speed rotary emulator for wave energy applications, and a wind turbine emulator that demonstrated the operation of a Doubly-Fed Induction Generator (DFIG) in a two-machine coupled rig. This paper also discusses some initial reviews of the training course. These reviews noted that students had a desire for more hands-on experimental work, and that the requirements to cover electrical safety material limited the amount of effective time available for experimental work. Finally, the paper outlines some approaches for improving the design of future laboratory experiments in this area.

1 Introduction

Traditional approaches to electrical engineering education use laboratory experiments based on standard, small-scale machine test rigs, and power system computer modelling packages (Heydt & Vijay, 2003), (Feisel et al., 2002), (Reed & Stanchina, 2010), (Kezunovic et al., 2004). While these are important and beneficial educational tools, the evolution of laboratory-based teaching over recent decades has been slow relative to the pace of change in industry. The combination of financial restrictions within university departments and increased levels of health and safety regulation can make the installation of high-cost, high-power teaching equipment very difficult. This can lead to a large gap between the curriculum of electrical engineering programs and the reality of modern industrial technology and techniques.

At the same time, a significant amount of research activity in Ireland and many other countries has moved out of university departments and into academic and industry research centres in recent decades (SFI, 2019). This approach has significant advantages, as it concentrates applied research activities and resources in strategic areas, and enables the development of research institutes that are closer to industry. However, one drawback in moving applied research from universities to external research centres is a greater separation of research activity from teaching activities. To help address these issues, this paper describes efforts to utilise advanced research infrastructure in the Marine and Renewable Energy Centre of Ireland (MaREI) for early postgraduate and undergraduate teaching purposes. The motivation of this work is to expose students to modern industrial technology and techniques in the teaching of electrical engineering and sustainable energy technologies.

MaRINET2 is a H2020 funded project on the integration and enhancement of European research infrastructures specialising in Offshore Renewable Energy (ORE) systems (Marinet2, 2019). One of the objectives of this project is to offer high-quality training relevant to ORE to academia and industry through short courses with a strong hands-on component. This includes hardware-in-the-loop (HIL) testing and simulations that provide students with opportunities to work with real-data obtained from sea trials. This approach is particularly useful when it is difficult to get access to actual ORE systems or when it is too risky to test various control schemes directly on the ORE converter (Mojlish et al., 2017). This cross-disciplinary short course took place in November 2019 at University College Cork (UCC) where relevant electrical laboratory training and experiments were performed at MaREI on the 28th November. Four groups carried out two experiments each on modelling and hardware-in-the-loop (HIL) simulation work. These models were emulated and tested on laboratory rotational rigs with power exported to the facility's microgrid or local grid. Industry specific learning outcomes are highlighted, and a comparison of current student engineering experiments with these newly developed experiments and teaching opportunities from the local linked research centre are carried out, with recommendations for improvement noted.

2 MaREI Electrical Testing Facilities for Marine Renewable Energy

The MaREI Electrical Laboratory in the Lir National Ocean Test Facility, at Ringaskiddy, Cork, Ireland, presents a range of electrical test infrastructures to help prepare marine renewable energy converters for sea trials. It consists of medium and high-speed rotary emulators, real-time hardware platforms and a microgrid. As such, using sea-trial data from actual ORE plants, various control algorithms for ORE converters can be developed, validated, and verified with the emulators. The configuration of the microgrid also allows models to be tested with various grid configuration and operation options. Figure 1 demonstrates the difference between sea trials, simulation work, and hardware emulation.

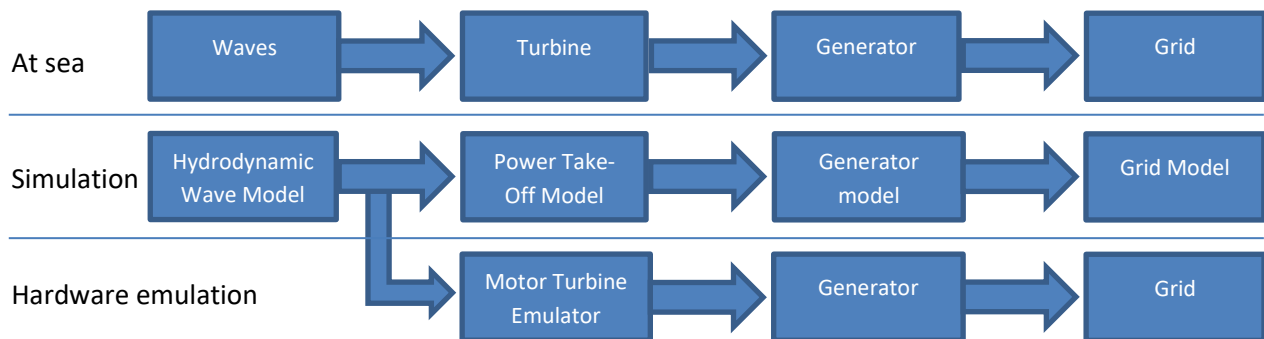

Figure 1: Sea testing Versus Simulation Versus Hardware emulation

Below, the configurations of the infrastructure are given first. Then, the HIL test and simulations performed at the training are described in detail.

2.1 Medium Speed Rotary Emulator

The medium speed rotary emulator is an electromechanical system used to replicate a rotating electrical power take-off (PTO) system for an Offshore Renewable Energy device and is shown in Figure 2 (Erdogan et al., 2019). The emulator is composed of two electrical machines directly coupled by a mechanical shaft with a torque transducer. The mechanical drive shaft also includes a flywheel, connected to the system by

a five-position gear box. The flywheel allows the drive shaft to be coupled to one of five different inertial masses, which can replicate the inertia of a system being tested. The prime mover, which is used to emulate the forces applied by an ORE turbine, is a 4-pole squirrel cage induction machine, rated 22 kW. The generator is a re-configurable slip-ring 4-pole induction machine, also rated 22 kW, where the rotor can be set in multiple configurations depending on the system which is being emulated. Speed and torque control of each machine is achieved by variable frequency drives. The full system is controlled by a Programmable Logic Controller (PLC), the industrial standard for operating dedicated power systems equipment.

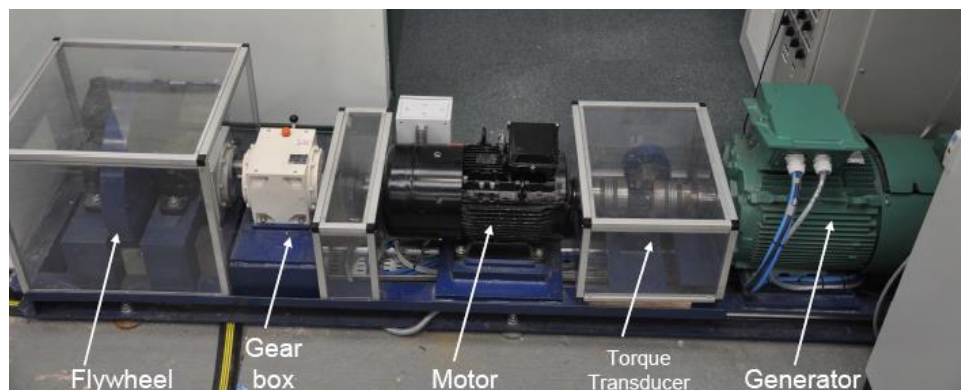

Figure 2: Drive train elements of the medium speed rotary emulator

HIL functionality is achieved with a multi-core CPU based real-time platform (e.g., *Speedgoat real-time machine*) that allows the emulator to fully integrate with software models running on MATLAB/Simulink. Conditions modelled in Simulink are relayed to the emulator machine, and the conditions of the physical hardware are fed back into the running model to affect outputs and complete the loop in real-time.

2.2 Microgrid

The microgrid is a dual bus, three-phase, 400 V local grid that can operate autonomously or in parallel with the distribution grid (Figure 3). The microgrid contains various sources and loads, as well as bi-directional power converters using real-time models that can emulate different loads, allow utilisation of energy storage, or emulate grids of different voltages and frequencies. The system contains an integrated supervisory control and data acquisition (SCADA) system, with high-frequency-sampling measuring equipment from National Instruments (NI) running on LabVIEW software. This equipment allows accurate measurements of voltages and currents, capturing their harmonic content and the effects of the control of the used hardware and software.



Figure 3: MaREI microgrid distribution panel

2.3 Wind Turbine Emulator

A modular and reconfigurable 5 kVA electrical power take-off kit for wind to wire system education in a university was purchased from Triphase NV. This kit consists of:

- Power conversion building blocks and filters suitable for motor drive and converter control
- Real-time control platform with MATLAB/Simulink programmable inverters and measurements
- Software libraries and examples to facilitate the design of applications

The specific lab setup is shown in Figure 4 where a Permanent Magnet (PM) machine emulates a wind turbine driving an induction machine configured as a doubly fed induction generator (DFIG). A model operating the power converters in real-time executes on a dedicated Linux based PC, with inputs to the operator PC allowing participants investigate voltages, currents and speed.

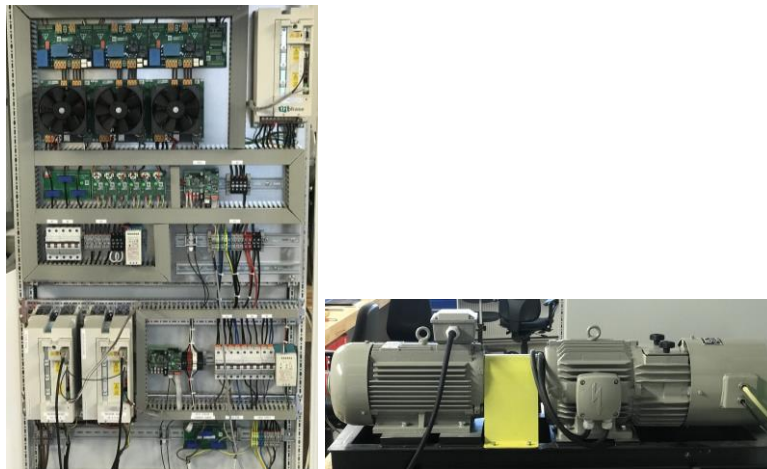

Figure 4: DFIG based wind turbine emulator and its driver

3 Course setup and comparison to typical lab setups

3.1 The MaRINET2 Course

Table I: Electrical lab schedule

9.00	G2: Safety presentation and Background and powers presentation	
9.45	G2A Medium speed emulator	G2B Wind turbine emulator
11.15	Break	
11.30	G2B Medium speed emulator	G2A Wind turbine emulator
1.00	Lunch	
2.00	G1: Safety presentation and Background and powers presentation	
2.45	G1A Medium speed emulator	G1B Wind turbine emulator
4.15	Break	

4.30	G1B Medium speed emulator	G1A Wind turbine emulator
6.00	Finish	

The MaRINET2 training consisted of a week-long short course for 20 participants on integrated tank testing for the Offshore Renewable Industry. It was jointly run by Ifremer, Technalia and UCC, focussing on a mix of presentations, case studies, lab work and project work. The electrical lab and testing work occurred on Thursday the 29th November, with the 20 participants divided into four groups. The electrical schedule is shown in Table 1 with each experiment having one supervisor.

This course was targeted towards early-stage researchers and postgraduate students, and the participation of interested applicants from industry, private sector companies, research groups, educational institutions was encouraged. For this course it was found that very few participants had an electrical/electronic engineering background. This led to the following desired learning outcomes for the laboratory:

1. Develop a healthy fear of electricity, and understand some best practice safety guidelines
2. Experience what is involved in electrical lab testing
3. Understand and appreciate Sea testing versus Simulation versus Hardware Emulation
4. Electrical equipment identification
5. Three phase power understanding

This course did not have a marked assignment. Participants followed a lab manual per experiment with supervisors assisting and clarifying with any issues.

3.2 Typical departmental lab setups

The typical lab setup for undergraduate and postgraduate students in electrical and electronic engineering in UCC takes place over a three-hour block, with each experiment typically being conducted by about four people with one supervisor per three or four lab setups.

The labs typically start with a safety talk, with a theory handout given in the weeks before the session and a workbook to work through and give up at the end of the lab. The labs are marked and count towards the student’s module grading. One example of an electrical lab experiment is shown in Figure 5.

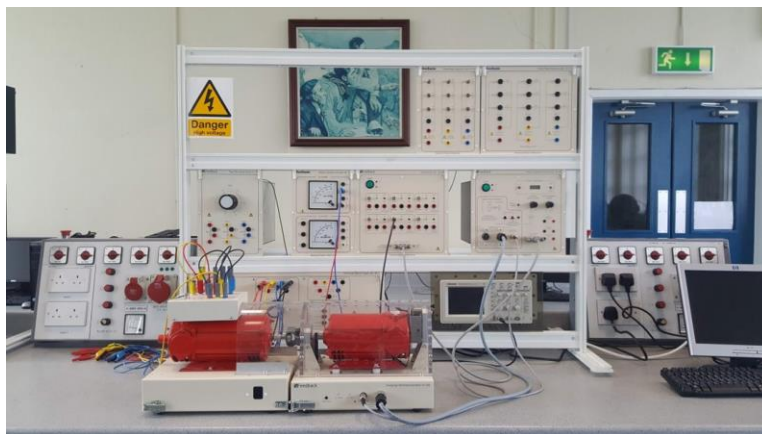

Figure 5: A three phase electrical engineering student laboratory setup using equipment from Feedback

4 HIL Experiments

4.1 HIL Emulation of a Wave Energy Converter

The purpose of this experiment is twofold. The first objective is to duplicate real-world electrical power output of a single oscillating water column converter in laboratory conditions. For this, a hydrodynamic software model in conjunction with the HIL based medium speed rotary emulator was used. The second objective is to analyse the grid integration of the renewable power generated using actual data from Mutriku buoy. This sea-trial data was collected within the OPERA project (OPERA, 2019).

In the training, students were asked to configure and control the emulator through HMI software. The data was collected at a sampling frequency of 20 kHz for 1-minute windows and line and load voltages and currents were measured. For the experiment, the rotor was configured as a squirrel cage induction generator. In the selected configuration, the emulator was connected to the distribution network through one of the microgrid buses and a resistive load of 15 kW was connected. During the experiment, various control schemes were tested. These were constant speed, constant torque, and HIL torque curve mode. For the constant speed and torque operational modes, students set different speed and torque values for the motor and generator drives. In the HIL mode, the turbine input torque was determined based on the hydrodynamic wave model in Simulink and sent to the PLC as a reference torque to drive the motor that acts as the turbine. The controller for the generator resides on the PLC and determines the generator braking torque. Figure 6 shows the load voltages and currents acquired during the HIL testing. After performing the test, students were asked to plot voltage and current data acquired, to calculate rms values of the measured quantities and to assess power and energy exported to the grid and load. Power quality issues were also examined.

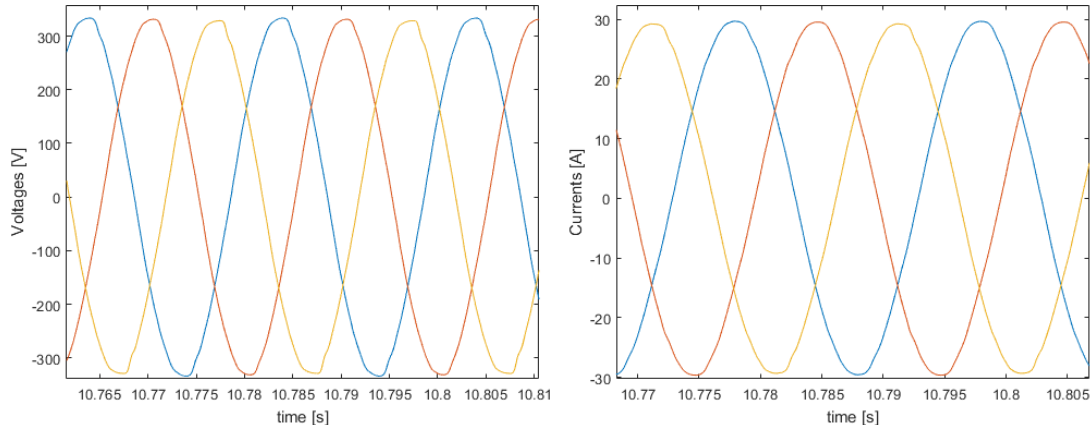

Figure 6: Load voltages and currents during HIL testing

4.2 HIL Emulation of a Wind Turbine

While the emulation of a wave energy converter experiment gave participants an insight into the typical electrical testing associated with ORE development, the objective of the emulation of a wind turbine experiment was to familiarise participants with industry standard electro-mechanical equipment, emulator test rigs and differences in measurements between ideal simulated values and real-world devices. The setup for this experiment is shown in Figure 7 where a Permanent Magnet (PM) machine fulfils the role of wind

turbine emulator. It should be noted that the grid feeding the PM machine and the grid to which the generator generates power is the same grid connection.

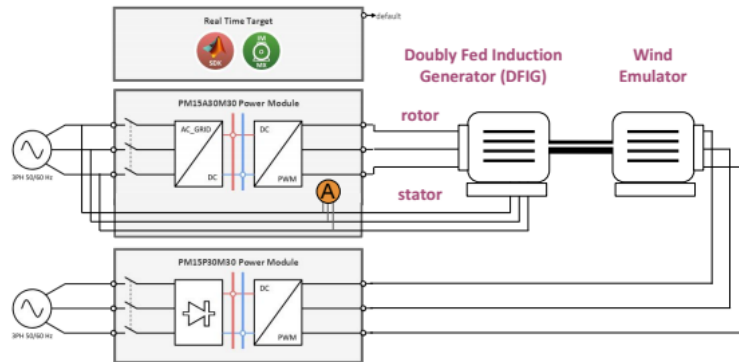

Figure 7: Wind turbine emulator lab setup

As many participants did not have an electrical/electronic background, the manual for this experiment consisted of (i) background information on the test rig and emulators, (ii) acronym usage in the industry, (iii) instructions on how to setup, check and operate the rig, (iv) further work and plot investigations as well as (v) troubleshooting. The controller PC used a web-based GUI to operate the rig with minimal inputs and clear real-time pre-scaled plotting available. A typical plot from this is shown in Figure 8.

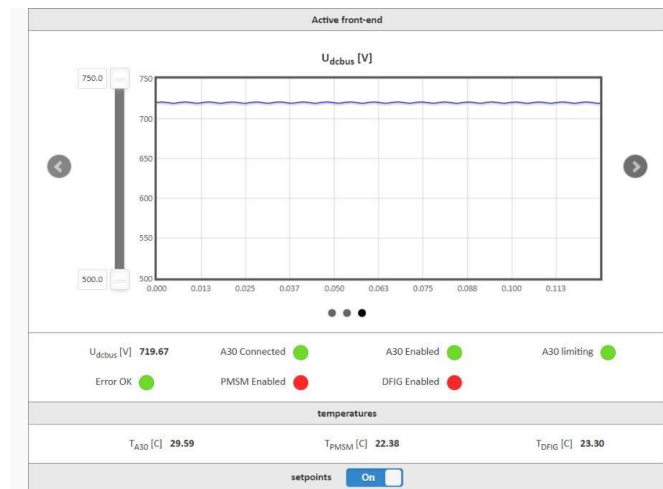

Figure 8: Voltage of the dc bus of the generator connected inverter showing some ripple

5 Conclusions

The two described experiments in this paper were developed as potential lab options for the engineering department in UCC. They were altered slightly and focussed for participants of the MaRINET2 training course which primarily had participants who were early stage researchers or postgraduate students studying offshore renewable energy devices. The review of the week-long course consisted of handouts to all participants allowing anonymous feedback. Applicable electrical lab feedback was that more and longer testing take place as participants enjoyed the hands-on component. This echoed feedback given by

participants to supervisors at the end of the experiments. The electrical lab related feedback was not collected using anonymous feedback forms and to develop this lab further this should be looked at. Feedback from the supervisors and paper writers found that:

- There was a responsibility for these labs to focus on electrical safety if participants had not had electrical laboratory/equipment experience previously, and this affected available limited time.
- Structuring the participants work in groups with a hands-off manner, fostered a dynamic and student-centred environment.
- Allowing participants work with industrial equipment and systems showing many connections hardwired to an industrial standard in a typical electrical panel as shown in Figure 4 gives an alternative laboratory environment, to the other departmental student labs. For example Figure 5 shows a lab with defined connection options using 4mm plugs.
- Avoiding the pressure of filling in a workbook to be graded, allowed minimal paper usage and a learning environment typical for a research centre.
- Simple learning outcomes such as three phase power understanding, helped focus explanations, and distributing soft-copies of well-commented MATLAB code on this topic aided this.

Further reflections on these labs as part of the training course, developed an idea of using established, coherent training courses and laboratory sessions in future for research centres as a source of income.

References

- Heydt, G. T., and Vijay V. 2003. Feeding our profession (power engineering education). *IEEE Power and Energy Magazine*, **1(1)**, 38-45.
- Feisel, L. D., Peterson G. D., Arnas, O., Carter L., Rosa A., & Worek, W. 2002. Learning objectives for engineering education laboratories. In: *32nd IEEE Annual Frontiers in Education, Nov. 6-9, Boston, MA*.
- Reed, G. F., and Stanchina, W. E. 2010. Smart grid education models for modern electric power system engineering curriculum. In *IEEE PES General Meeting, July 25-29, Providence, RI*.
- Kezunovic, M., Ali A., Huang, G., Bose, A., & Tomsovic, K. 2004. The role of digital modeling and simulation in power engineering education. *IEEE Transactions on Power Systems*, **19(1)**, 64-72.
- SFI. 2019. *SFI Research Centres*. <http://www.sfi.ie/sfi-research-centres/>.
- MaRINET2. 2019. *Marine Renewables Infrastructure Network for Emerging Energy Technologies*. <http://www.marinet2.eu/about/>.
- Mojlish, S., Erdogan, N., Levine, D., & Davoudi, A. 2017. Review of hardware platforms for real-time simulation of electric machines. *IEEE Transactions on Transportation Electrification*, **3(1)**, 130-146.
- Rea, J., Kelly, J., Alcorn, R. & Sullivan, D.O. 2011. Development and operation of a power take off rig for ocean energy research and testing. In *European Wave and Tidal Energy Conference, Sept 5-9, U.K.*
- Erdogan, N., Murray, D. B., Giebardt, J., Wecker, M., & Donegan, J. (2019). Real-time hardware emulation of a power take-off model for grid-connected tidal energy systems. In *2019 IEEE International Electric Machines & Drives Conference (IEMDC), 1368-1372, May 12-15, San Diego, CA*.
- OPERA. 2019. *Open sea operating experience to reduce wave energy costs*. <http://opera-h2020.eu/>.

One Assignment, Two Courses, Multiple Skills: A Major Engineering Assignment with Social, Political and Ethical Dimensions

Vivian E. Neal¹, Taco Niet¹, Daina Vuong Baker¹

¹School of Sustainable Energy Engineering, Simon Fraser University, Canada

vneal@sfu.ca

Abstract

This paper discusses a major interdisciplinary assignment that spans two first year courses in the School of Sustainable Energy Engineering (SEE) at Simon Fraser University, Canada. The Persuasive Research Paper asks students to draw on ideas from multiple scholarly disciplines and fields of practice to argue a social, political, or ethical position in relation to a technical, engineering, or scientific topic. It is a combined assignment across two SEE courses, *Energy, Society and Environment*, and *Process, Form and Convention in Professional Genres*, and is intended to prepare students for future courses in the SEE program, their co-op placements, and their professional responsibilities as an engineer. Students are required to research and write a paper exploring opposing positions related to an area of controversy chosen from a list of topics supplied by the instructors. The assignment consists of four components, each of which involves a draft and final version, and peer reviews. Two preliminary assignments help students to plan their research, frame the position they will take on their topic, and conduct scholarly research. These prepare students for the other two components, a technical analysis and the final paper. For the peer review, students are grouped into threes and each person uses established criteria to review their group members' papers using the ACE (Analytical, Constructive and Empowering) model of feedback. Students learn the skills of finding and using scholarly resources, and using persuasive arguments that draw on reliable sources and evidence. Also, throughout the assignment, students are practicing leadership skills, learning written and oral communication skills, and gaining a breadth of knowledge about energy, sustainability and society.

1 Introduction and Background

Systems thinking, critical thinking, complexity, and interdisciplinarity are important components of education for sustainable development (Cotton & Winter, 2010; Neal & Langley, 2012; UBC, 2018). To integrate these into an already crowded engineering curriculum, two faculty members in the School of Sustainable Energy Engineering created a major interdisciplinary assignment that spanned across two first year courses. One of the courses is on writing and communications entitled, *Process, Form and Convention in Professional Genres* (SEE 101W), and the other is an introduction to sustainability and energy, *Energy, Society and Environment* (SEE 110). Two of the authors of this paper, Vivian Neal and Taco Niet, are the faculty members who teach these courses, and the third author, Daina Baker, was the teaching assistant for both courses in Fall 2019. This paper describes the motivation for the assignment, the assignment structure and delivery, the perspectives of the instructional team, and an assessment of its success.

The School of Sustainable Energy Engineering at Simon Fraser University welcomed its first students in September 2019. The first of its kind in Western Canada, the program is housed in a new state of the art facility in which students interact with, and learn from, the sustainable energy features of the building. (For details about the SEE program, see Neal *et al.*, 2018.) Consistent with current literature about education for sustainable development (Goldberg & Somerville, 2016; Sheppard, 2009; Winter, Cotton, Grant & Hopkinson, 2015), the program is interdisciplinary, and emphasises experiential learning and communication skills. In addition, it exposes students to industrial paid work experiences through the co-operative education program, as well as community driven projects and collaborative research opportunities.

2 The Two Courses

Process, Form and Convention in Professional Genres is in some ways a conventional first year engineering communications course, covering technical writing, communicating persuasively, giving presentations, and working in a team. Its differentiating characteristic is how pedagogies consistent with education for sustainable development have driven the course design. Students are active participants in their own learning, learning from each other in collaborative learning activities. They work in groups and individually, engaging in critical thinking and reflection exercises. A notable example is that most assignments are peer reviewed by fellow students, to improve communication skills, develop empathy, and clarify ideas about sustainability. In addition to the major combined assignment detailed in this paper, students research and write two short papers related to the United Nations Sustainable Development Goals; this exercise provides students with some foundational understanding of sustainability and sustainable development.

Energy, Society and Environment covers a variety of topics related to energy and sustainability, and the social, political and environmental implications of the materials, water and energy flows required to support human society. Both local environmental and sustainability issues, and global challenges in sustainable development are explored to provide students context for their future careers in sustainable energy engineering. Typical learning activities include students calculating their energy footprint compared to the average energy footprint of other societies around the globe, and creating energy chains from source to end use with calculating their material and energy flows. In addition to gaining technical knowledge, students interact and learn from each other using various teaching structures such as 25/10 crowd sourcing (Liberating Structures, 2020) to obtain topics they would like to learn about, think-pair-share discussions of different topics, and open classroom discussions about the responsibility of an engineer in society.

For Fall 2019, 46 students were enrolled in total, with 36 enrolled in both courses and 10 enrolled in only one or the other.

3 Combined Assignment – Persuasive Research Paper

For the Persuasive Research Paper students argue for a social, political, or ethical position in relation to a technical, engineering, or scientific topic. Students are encouraged to select their topic from a provided list or chose their own in consultation with the course instructors. Rather than simply describing a technology or issue, students are required to explore opposing positions of a controversy and then adopt a position and argue in favour of that position using evidence and persuasive strategies. Through this research and writing process they analyze and synthesize some of the complexities of real-world sustainability issues such as the interlinked problems of energy consumption, climate change, resilient governance, loss of biodiversity, and poverty. They must approach this work with an interdisciplinary lens and systems-level thinking because such issues cannot be sufficiently understood in isolation.

The length of the final paper was 2500-3000 words for students taking both course and 1700-2000 words for students taking only of the courses; all other criteria for the Persuasive Research Paper were the same for both groups.

3.1 Assignment Components

The assignment, worth 40% of the marks in SEE 110 and 30% in SEE 101W is a major term activity for the students and consists of several components as shown in Table 1. These components help ensure that students are working on their topics throughout the term, where each component includes a draft, ACE peer feedback on that draft, and a final submission.

Table 1: Assignment Weighting

Assignment Component	Grading Weight	
	SEE 101W	SEE 110
Planning and Strategies	5%	5%
Annotated Outline and Sources	5%	5%
Preliminary Technical Analysis	Not Applicable	10%
Persuasive Research Paper	20%	20%
TOTAL	30%	40%

The *Planning and Strategies* assignment helps students to define their topic and plan their paper. At 500 words, it includes their research question, a description of the purpose, audience and message of the paper, at least 4 “mini” questions that will guide their research, and a description of the writing process they plan to use.

Mini questions are sub-topics that need to be researched in order for the student to complete the main research question. In SEE 101W, students practice creating “mini” questions through a series of exercises. In one activity, the instructor writes a series of research questions on the white boards around the room and students are given sticky notes on which they pose mini questions about at least one of the questions on the boards. They then post their notes on the boards, review the mini questions of other students, and collectively group them by themes. This helps students develop critical thinking skills, research skills,

writing skills, and empathy, where they are physically moving around the room, in a low-stakes atmosphere of sharing their work and learning from each other.

The *Annotated Outline and Sources* assignment consists of an introductory paragraph to help students formulate a compelling thesis, and an annotated reference list to help students identify scholarly sources and reflect on the utility of each source. In SEE 110, students keep a research journal for which they read two or three articles each week, summarize them, and describe how each relates to their topic. Feedback from the instructor on these journals guides students towards appropriate reference sources.

For the *Preliminary Technical Analysis*, which is submitted in only SEE 110, students must provide the technical reasoning for taking their position, supported by calculations and/or references to technical papers or sources. The analysis shows how the evidence from the literature, and/or students' calculations, supports their position.

The final component is the *Persuasive Research Paper* itself which relies on, and incorporates, the first three components. Through the preliminary assignments, students have already completed the planning and research before they start writing their final paper. Each component builds student competence and allows them to develop their skills and gather information for the final research paper.

3.2 Peer Reviews, ACE Feedback, and Polished Drafts

For each assignment component, students produce a polished draft, and review the papers of two classmates, before submitting their final version for grading. In addition, the teaching assistant provides formative feedback on the polished draft of the Persuasive Research Paper to ensure students receive consistent feedback. Note that for the three preliminary assignments, the teaching assistant does not review the drafts.

To set up the peer reviews, students are randomly assigned to groups of three or four at the beginning of the course. In peer review sessions students use the Analytical, Constructive and Empowering (ACE) model of feedback: *analytical* in that comments will have a good depth of analysis about the paper, *constructive* in the sense that it helps the author understand the issues as well as how the issues can be addressed, and *empowering* to inspire confidence in the author's ability to improve their writing.

For the first three assignment components, the peer reviews are conducted during tutorial sessions and the peer review process is overseen by the teaching assistant. However, for the draft of the final paper, the peer review is initially conducted through the electronic exchange of papers, using the markup features of MS Word. Students then spend time in class discussing the written peer feedback within their groups.

4 Results and Observations

Overall, the student and instructor observations indicate that the combined Persuasive Research Paper assignment in SEE 110 and SEE 101W is a worthy activity for the students. Instructors and the teaching assistant found that the combined assignment helped students developed multiple skills, but also noted some challenges that need to be addressed for future offerings.

4.1 *Multiple Skills*

SEE 110 and SEE 101W provide a strong foundation for students' future studies and co-operative education semesters, and set the stage for their future practice as professional engineers. As such, exposure to a variety of professional and scholarly skills, approaches to knowledge acquisition, and collegial communication are vitally important (Sheppard, 2009).

The Persuasive Research Paper helps students learn the skills of finding and using scholarly resources, using persuasive arguments that draw on reliable evidence, and developing critical thinking and writing skills. Through lectures, readings, and practice, they learn to paraphrase and summarize concepts from source material, learn proper citation and referencing procedures and styles, and how to create a persuasive argument. Additionally, students delve deeply into a topic of their choosing that is aligned with their interests and are therefore motivated to invest the time and energy to learn and engage, enhancing their breadth of knowledge about energy, the environment, sustainability and society. Through giving and receiving peer feedback, students not only improve their own written and oral communication skills, but help enhance the skills of their peers.

Overall, the Persuasive Research Paper helps students develop a variety of valuable skills and abilities including:

- Analytical skills through analysing and using set criteria to give feedback
- Knowledge literacy through engaging with the scholarly literature and identifying what constitutes reliable and less reliable sources
- Written and oral communication skills through research-informed discussions
- Appreciation of the interdisciplinary and complex nature of sustainability challenges
- Systems-level thinking, and
- Collaboration and group work skills, and empathy for their fellow students.

Most of these skills are identified by Engineers Canada as required Graduate Attributes; future work on measuring progress towards these Graduate Attributes will be incorporated in the courses in future iterations.

4.2 *Reflections of the Instructional Team*

Table 2 provides some reflections from the instructional team on their experiences. In general, the instructors observed that the assignment was a success and intend to continue the combined assignment next year with some minor modifications.

Table 2. Reflections of the Instructional Team

<p>Taco Niet, Instructor SEE 110</p> <ul style="list-style-type: none">• Having a combined assignment in SEE 110 and SEE 101W allowed for a more in-depth paper than students would have been able to write if two separate assignments were required in the two courses. I think this provided students with a valuable learning experience and I am excited about enhancing this experience even further for the next iteration of the course.

- One challenge I experienced in SEE 110 is that I did not anticipate the level of student understanding of technical concepts related to energy. Students' lack of some basic concepts made it more challenging for them to take a technical position on their topics. I look forward to addressing some of these basic gaps in knowledge in the first part of SEE 110 next year so students are better prepared to take a persuasive position and support it.

Vivian Neal, Instructor SEE 101W

- One of the challenges that I didn't anticipate is that the quality of polished drafts was inconsistent. This affected the depth and usefulness of the peer feedback in some groups. That is, when a student brought in a very rough draft, their peers could not provide constructive feedback. In the future, we will give a very small mark for the drafts (about 10% of the revised submissions) to encourage more polished work for the peer reviews.
- I believe that *empathy* and *empowerment* are central to our core beliefs in ourselves, our self-efficacy, and our ability to contribute and interact as professionals. The peer review exercises rely on these qualities to be present in the classroom, established by the leadership of the instructional team. We are very lucky that the instructional team was able to establish a classroom atmosphere and culture that was supportive and safe.

Daina Baker, Teaching Assistant SEE 110 & SEE 101W

- It was remarkable to see students' passion for the topics they were researching and writing about, and excited about making a sustainable world. We are equipping individuals with the tools to realize this future.
- The peer review process was successful in providing students with a chance to interact with students they might not otherwise speak with. The exercise gave students practice in developing their own arguments as well as the arguments of their peers.
- Students seemed to struggle in areas that required scientific background. They sometimes did not make full use of, or misinterpreted, information and data, and therefore drew erroneous conclusions or merely presented information without meaningful analysis.

5 Challenges and Successes

For the most part, students engaged well with the assignment and were enthusiastic about being able to investigate a topic of their choosing. Several students commented that they much prefer to investigate and write about sustainable energy topics than the topics from their English courses in secondary school. Most students were able to write a persuasive research paper that effectively argued for a specific position on a topic, including identifying reliable data sources, referencing sources effectively, and using Zotero (a reference management system) to keep them organized.

Regarding challenges, most students were not clear on how to technically argue for a position as required by engineers, versus making an emotional or rhetorical argument. Most first year students have little technical background. Other challenges include:

- Confusion about which course the assignment was for, since much of the assignment related activity was in SEE 101W only; the instructors will address this in future iterations of the assignment.
- Bringing in minimal drafts for the peer review sessions. This impacted the quality of learning since students didn't have an opportunity to practice giving feedback and authors didn't receive constructive feedback on a draft.
- When sourcing material, students successfully focussed on peer reviewed articles, but often didn't understand the subtleties of what makes a good reference.

5.1 Notes About Future Iterations of the Assignment

The first execution of the assignment went fairly smoothly, but some revisions will be made for future iterations:

- Incorporate additional issues in the list of potential topics based on recent discussions with the staff of the local municipal sustainability office.
- Add more guidance to SEE 110 about the technical analysis, and adjust the weight of the Preliminary Technical Analysis from 10% to 5%.
- Deduct marks if drafts are not polished, to ensure the peer review sessions run smoothly.
- Require students to submit a reflection of their preliminary assignments with their final paper, including how their mini questions informed their research process, and how their original outline changed as they developed their ideas.
- Revise the session about referencing to help students understand the subtleties of good referencing, especially the reliability of sources from peer reviewed, to government and institutional, to Wikipedia, to random website.

6 Conclusion

The combined Persuasive Research Paper assignment offers first year Sustainable Energy Engineering students in SEE 110 and SEE 101W the opportunity to grapple with some of the complexities presented by real-world sustainability issues and technologies. When they argue for a particular position, supported by evidence from the scholarly literature, they necessarily must approach the problem with an interdisciplinary lens and systems-level thinking. This experience establishes the attributes and skills to approach their future studies and professional activities with an appreciation of the vagaries and interdisciplinary nature of sustainability challenges. In future iterations of this assignment, the authors plan to make several minor, but important, adjustments. The instructors are continuing to dialogue with local city staff about potential projects and topics for this combined assignment with the hope of making the exercise even more meaningful for students.

References

- Cotton, D.R.E. & Winter, J. 2010. 'It's not just bits of paper and light bulbs': A Review of Sustainability Pedagogies and Their Potential for Use in Higher Education. In: Jones, P., Selby, D. & Sterling, S. Eds. *Sustainability Education: Perspectives and Practice Across Higher Education*. Routledge.
- Goldberg, D.E. & Somerville, M. 2016. *A Whole New Engineer: The Coming Revolution in Engineering Education*. Three Joy Associates.
- Liberating Structures. 2020. *25/10 Crowd Sourcing*. Accessed Feb. 15, 2020: <http://www.liberatingstructures.com/12-2510-crowd-sourcing/>
- Neal, V., Oldknow, K., Edgar, J., Bajić, I., Trautman, M. & Moallem, M. 2018. A new program in Sustainable Energy Engineering: Balancing subject matter with transformative pedagogies to produce global citizens. Proc. of the 9th Engineering Education for Sustainable Development, Jun 3-6, 2018, Glasboro, NJ, USA
- Neal, V. & Langley, G. 2012. Education for sustainable development and accredited programmes. In *Putting the 'S' into ED: Education for Sustainable Development in Educational Development*. SEDA Special 31 (Eds: Cotton, D.R.E., Sterling, S., Neal, V. & Winter, J.)
- Sheppard, S.D. 2009. *Educating Engineers: Designing for the future of the field*. Carnegie Foundation for the Advancement of Teaching. San Francisco, CA: Jossey-Bass.
- University of British Columbia. 2018. *UBC Sustainability Initiative: Sustainability Attributes*. Accessed Feb. 15, 2020: <https://sustain.ubc.ca/courses-teaching/sustainability-learning-pathway/sustainability-attributes>.
- Winter, J., Cotton, D., Grant, V. & Hopkinson, P. 2015. The University as a Site for Transformation around Sustainability. *International Journal of Innovation and Sustainable Development*. 9(3/4):303-320.

Exploring Transdisciplinary Education

S. Nesbit¹, N. Ellis², S. Danes³, T. Tan¹, E. Byrne⁵, D. Morgan⁶, and J. Orozco-Messana⁷.

¹Department of Civil Engineering, University of British Columbia, Canada

nesbit@civil.ubc.ca

²Department of Chemical and Biological Engineering, University of British Columbia, Canada

³School of Architecture, Carnegie Mellon, United States

⁴Institutional Research, Langara University, Canada

⁵Department of Process and Chemical Engineering, University College Cork, Republic of Ireland

⁶Department of Engineering, University of Cambridge, U.K.

⁷Department of Mechanical and Materials Engineering, Universitat Politècnica de València, Spain

Abstract

Because wicked Sustainability Problems (WSPs) are complex, multi-scaled, value-laden, ill-structured, and difficult to address (for example see Lonngren et al., 2016), teams that include engineers and others with expert knowledge are needed to effectively manage WSPs relating to environmental stress and declining ecosystem health, including WSPs stemming from resource scarcity, biodiversity loss, and climate change. How do we educate engineers to successfully engage in such transdisciplinary teams? What is transdisciplinary education? This paper explores aspects of these questions.

First, we review areas of education literature relevant to transdisciplinary teaching and learning, including frameworks such as “Threshold Concepts” (Meyer & Land, 2006) and “Empathic Thinking” (Walther et al., 2017), and pedagogies reported in the literature, including “Value Analysis”, and “Learning Communities” (McGregor, 2017). We introduce the design-based research methodology (DBR) as a framework for developing transdisciplinary education, and we offer a review of the engineering education literature relevant to transdisciplinary training.

Next, a case study employing DBR is presented. This case, inspired by the work of Tejedor & Segalas (2018a) and others, extends the work presented by Morgan et al. (2018), which reports a novel sustainable development workshop experience for masters-level graduate students, organized and hosted by the Universitat Politècnica de València (UPV) in the spring of 2017. A second workshop was deployed in June of 2018, during which students from a variety of backgrounds and institutions gathered in UPV to create locally relevant, sustainable, conceptual designs for the built environment. The DBR case study focuses on this 2nd workshop, during which survey, interview, and focus group data reflecting both the student and the facilitator experiences, were collected. An initial interpretation of this data is presented.

This paper contributes to engineering education for sustainable development because it emphasizes a meta-framework which conceptualizes the development of transdisciplinary education experiences and which has the potential to enable faculty to reflect on and improve novel transdisciplinary experiences.

1 Introduction

Complex sustainability problems in cities, including those relating to natural disasters, resource scarcities, affordability, equity, biodiversity loss, and climate change, are ill-structured, value-laden, multi-layered, and lacking in definitive solutions. These problems are notoriously hard to address. Yet, transdisciplinarity, which involves enacting ‘disciplinary humility’ (Byrne et al., 2017, p.14) to undertake a shared search for strategies and actions among stakeholders who recognize that knowledge takes many forms, offers an approach by which cities can successfully navigate sustainability challenges (Ramaswami et al., 2018).

These wicked sustainability problems (WSPs) are changing the nature of work for those engaged in creating the built environment. The authors of this paper recognize the gap between common teaching and learning practices within our fields (which focus on solving structured problems within disciplinary norms), and the demands of the transdisciplinary work environment of engineers and other built-environment professionals. As facilitators of a one-week international workshop, hosted by the Universitat Politècnica de València in June of 2018 and aimed at training students in sustainability, we view our workshop experiences as a case study of transdisciplinary education, and we explore transdisciplinary education from the perspective of engineering for sustainable development.

2 Literature

2.1 *Transdisciplinary Education at Universities and Colleges*

Since the 1970’s, scholarly discourse within the field of transdisciplinary includes discussions relating to the nature of knowledge, research methodologies, and problem-solving methodologies (Klein, 2014). Papers focusing on education in support of student development of transdisciplinary skills appeared around 2000 (for example, see Welch et al., 1996; Ertas et al., 2003; Derry and Fischer, 2005) and, today, the study of transdisciplinary education is an active field.

In her review of transdisciplinary training in higher education (2017), McGregor suggests that transdisciplinary problem solving is

“... an educative process that affects professional development whereby, while engaged in transdisciplinary work, individuals are transformed from immature to mature co-participants...”

For her, transdisciplinary education at universities exists at the nexus between professional development, learning, and knowledge creation within complex situations, and the highest quality education requires transdisciplinary learning experiences that integrate disciplinary knowledge within the larger societal context.

Transdisciplinary education involves the cultivation of transdisciplinary ways of thinking, including empathic thinking, the ability to recognize patterns, the synthesis of different knowledge types (Mishra, et al, 2011), and the ability to metacognate (Derry and Fischer, 2005). These are what McGregor labels “transdisciplinary habits of mind” (2017).

2.2 *Transdisciplinarity in Built-Environment Education*

Papers describing and investigating transdisciplinary education appear within built-environment disciplines (for example, see Riley et al., 2006; Byrne & Mullally, 2016; Bronwell, 2016; Oliveira and Marco, 2017;

Lonngren et al., 2016; Greenhalgh-Spencer et al., 2017; Payne and Jesiek, 2018). Tejedor and Segalas (2018a) report a ground-breaking “action research workshop for transdisciplinary sustainability science” offered at the Universitat Politècnica de Catalunya, as part of its Masters degree in Sustainability Science and Technology. During the one-semester workshop, students, who typically come with engineering or architecture backgrounds, work in teams on sustainability challenges identified by local stakeholders. Authors report workshop learning outcomes that can be summarized as the abilities to:

- understand various research paradigms, including positivism, interpretivism, critical theory, and pragmatism and are able to apply the appropriate paradigm in a given context.
- participate and contribute in transdisciplinary research.
- apply the action research methodology to complex sustainability problems and understand the interdependencies between, and influences of, local actions on larger scale social and ecological issues.
- practice reflection such that a deeper understanding of social dynamics resulting from the transdisciplinary approach to complex sustainability problems is enhanced.

Tejedor and Segalas also report that, during the workshop, students often face conflict and frustration when working with teammates and community members. To support student development in these situations, a module on emotional intelligence is introduced.

In a second paper, Tejedor et al. (2018b) offer a sophisticated analysis of the transdisciplinary education literature and describe three dominating discourses, namely “transcendence”, “problem-solving”, and “transgression”, and have found that transdisciplinary engineering education experiences exist within the problem-solving discourse. Further, teaching and learning experiences within the problem-solving discourse tend to span disciplinary boundaries timidly, while simultaneously embracing extensive stakeholder participation in the problem-solving process.

2.3 Frameworks of Student Knowledge, Pedagogies, and Faculty Learning

Tembrevilla et al. (2019) propose a conceptual framework, presented in Figure 1, representing the array of knowledge constructed by individuals with transdisciplinary characteristics. Inspired by the work of Walther et al. (2017), this conceptual framework suggests that the potential of a student to work well in transdisciplinary teams depends on three knowledge dimensions, namely “beliefs and values” (i.e. one’s professional way of being), “attitudes” (i.e. one’s practice orientation), and a basket of “competencies” (skills) that, together, enable an individual to succeed in a transdisciplinary environment. The framework illustrated in Figure 1 demonstrates the interdependent and synergistic relationships between dimensions.

A second working framework, focusing on the *process* of knowledge construction, also supports the design of transdisciplinary education. Because transdisciplinary knowledge can be difficult to develop, and, once obtained, forever changes the learner’s perspective, the threshold concept framework, developed by Meyers and Land (2006) may be appropriate. Threshold concepts are initially difficult to comprehend because they challenge the learner’s world view, including the learner’s sense of identity. As with entering a transformational portal, the learner experiences levels of engagement and knowledge characterized by dissipating un-ease and resulting in the learner’s changed state. In the case study presented here, the threshold concepts framework is used to define levels of student development of transdisciplinary characteristics.

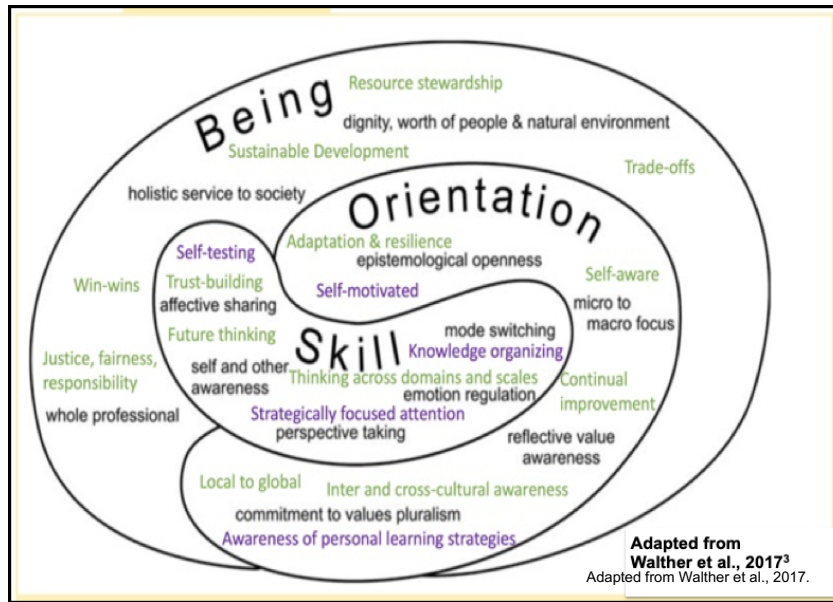

Figure 1: A conceptual framework illustrating selected values and beliefs, attitudes, and competencies associated with empathic thinking (black font), systems thinking (green font), and metacognition (purple font). Together, these attributes represent a proxy for all personal characteristics and abilities contributing to an individual’s transdisciplinary characteristics (Tembrevilla et al., 2019).

McGregor (2017) offers a number of pedagogies which may enable students to think “beyond” disciplinary norms, and enabling them to work with those possessing different world views to discover a new understanding (p. 15). Such pedagogies include:

- *authentic curriculum*: where learning activities are “centred on issues that are topical and relevant to the students’ lives and the troubles of the world”;
- *value analysis*: where “students become aware of other people’s values by analyzing others’ viewpoints”;
- *learning communities*: where groups of learners who “share membership, influence, need fulfilment, events, and connections” as they learn together; and
- *deep education*: which is “context-specific, participatory, holistic, integrative, eco- and learner-centered education....”.

In addition to knowledge and learning frameworks, and transdisciplinary pedagogies, we suggest that a foundational component of transdisciplinary education development is design-based research (DBR) (The Design-Based Research Collective, 2003; O’Neill, 2012), a methodology aimed at continually learning about and improving the education experience. DBR is characterized by successive iterations of curricular designs. Similar to some forms of engineering practice, the essential idea of DBR is to use progressive, repeated, refinement of instructional design to drive discovery.

3 Transdisciplinary Education Development Meta-Framework

To support the design of effective and efficient transdisciplinary education, we employ a meta-framework for transdisciplinary education development. The meta-framework, illustrated in Figure 2, includes the material presented in section 2.3 above, namely the conceptual framework of student knowledge (i.e.

“Transdisciplinary Characteristics”), the framework of student development (i.e. “Staged Learning”), effective transdisciplinary pedagogies (i.e., “Transdisciplinary Education Pedagogies”), and an overarching methodology by which educators continually improve the learning experiences of their students (i.e. “Design-Based Research Methodology”).

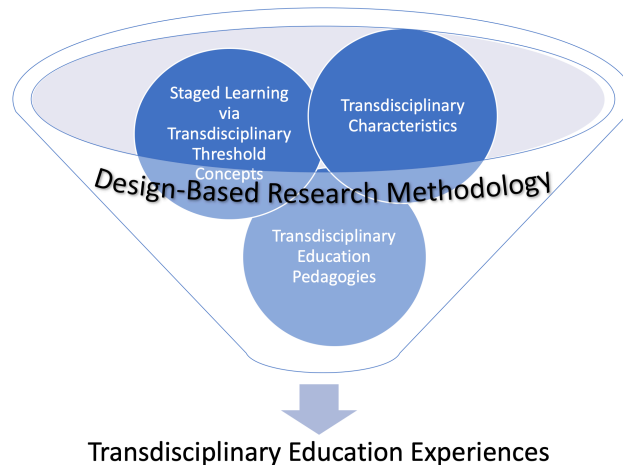

Figure 2. A meta-framework conceptualizing the development of transdisciplinary education experiences

4 Case Study

An annual week-long, intense, workshop aimed at enhancing the transdisciplinary abilities of approximately twenty students is explored in this paper. Engineering, planning, and architecture students from diverse programs offered in European and North America gather with local students (engineering and architecture) at the Universitat Politècnica de València (UPV), España, for the Interdisciplinary Sustainable Architecture (ISA) Lab workshop, during which interdisciplinary and cross-cultural student teams work on sustainability-focused built-environment projects proposed by the Valencian community (i.e. local community organizations, businesses, and municipalities).

Three workshops have taken place. The first, offered in 2017, is reported by Morgan et al. (2018). The focus of this paper is the 2018 workshop. Experiences reported here informed the implementation of the third workshop, which took place in June 2019.

The learning outcomes of the ISA-Lab 2018 workshop are:

- Synthesize potential solutions to real-world sustainability problems for real clients, based on perspectives-taking and applying sustainability approaches
- Engage in self-assessment and self-reflection in articulating one's own values and understanding how they inform one's perspectives
- Demonstrate and develop capacity for active listening and to work successfully with team members from different disciplines

Learning activities include daily lectures, team project work facilitated by faculty and supported by community partners and local leaders, a city tour, social activities, and scoping field trips for some teams. The week culminates in a presentation and short report given to local stakeholders and project proponents. For a description of these workshop activities, see Morgan et al. (2018).

While this paper focuses on the development of knowledge pertaining to transdisciplinarity, systems thinking, empathic thinking, and metacognition, none of these topics were explicitly discussed during the 2018 workshop learning activities.

5 Workshop 2018 Data Collection and Interpretation

To evaluate student development of their transdisciplinary characteristics, survey and interview data were collected at the end of ISA-Lab 2018. The focus of data collection included assessing student levels of systems thinking, empathic thinking, and metacognition. Data collection and interpretation protocols developed by Nesbit et al. (2017), Tan et al. (2018), and Trembrevilla et al. (2019) were employed.

5.1 Research Question and Data Collection Protocol

The research question developed as part of the DBR methodology is: *Does a multi-day, project-based, sustainability design workshop involving masters-level students from different disciplines taught in different institutions, support the development of transdisciplinary skills?*

A mixed methods experimental protocol (Johnson & Onwuegbuzie, 2004) was employed. Post-workshop self-evaluation survey data from students, statements made during post-workshop student focus group discussions, and reflections on the focus group discussions, written by focus group facilitators, were collected. The qualitative data (facilitator reflections and student statements made during focus group discussion) were first “cleaned” by removing statements not relevant (i.e. not pertaining to the concepts of transdisciplinarity, systems thinking, empathic thinking, and metacognition), and then four authors coded 108 statements (i.e., cleaned data) by first identifying the most relevant concept for each statement and then labeling the statement as aligning with 1 of six levels of knowledge, with 6 being the highest level of knowledge. The average level for each concept was calculated.

5.2 Summary of Data Analysis

Table 1 presents a summary of the survey data, student focus group statement analysis, and the analysis of focus group facilitator written reflections.

Table 1: Summary of Data Analysis

Data Type	Average Level of Transdisciplinary Knowledge (out of 6 levels)	Average Level of Systems Thinking Knowledge (out of 6 levels)	Average Level of Empathic Thinking Knowledge (out of 6 levels)	Average Level of Metacognition (out of 6 levels)
Student Self-Evaluation Survey	***	Improvement as a result of workshop activities	Improvement as a result of workshop activities	Improvement as a result of workshop activities
Focus Group Discussion (FDG) Statements	4	***	***	***
Facilitator Written Reflections on the FDG	5	4.5	4.5	5

*** = no data available

Overall, the data suggests that, upon completion of the workshop, student knowledge of transdisciplinarity, systems thinking, empathic thinking, and metacognition was evident among the participants, even though these concepts were not explicitly discussed during the workshop. Further, as part of the survey, students were asked which learning activity they found most useful in helping them develop their knowledge of systems thinking, empathic thinking, and metacognition. While each activity was identified by at least one student, team discussions were mentioned more than other activities as influential in developing transdisciplinary characteristics, especially for developing empathic thinking.

6 Discussion

6.1 The Transdisciplinary Education Meta-Framework

The meta-framework (Figure 2) contextualizes the ISA-Lab workshop experiences and may inform the continual improvement of future workshops and other teaching and learning experiences. For example, a learning activity selected from the list of transdisciplinary pedagogies offered by McGregor (2017) may be employed to support student development of specific transdisciplinary skills. Workshop developers may determine student progression, while simultaneously learning to continually improve workshop experiences, by applying the threshold concept framework to measure student progress. But, this nascent meta-framework lacks detail and structure. Which pedagogies best support specific transdisciplinary skills? Are some transdisciplinary skills more transformative, and therefore more difficult to learn, than others?

6.2 Case Study

Results suggest an improvement of transdisciplinary skills and that small-group discussions may especially support this development. FGD facilitators' written reflections offer insights into possible indicators of this development. For example, perspective-taking by students during the focus group discussion, and the absence of a dominant disciplinary language during project team discussions, were identified. In one case, the facilitator noted a three-member team speaking in a "fourth language" – i.e. communicating with language accessible to all team members. Also, students appreciated being alerted by faculty to the inherent challenges of working on WSPs. Overall, faculty members observed that most teams produced a deliverable to their client that could not have been created by one discipline only. That is, the final deliverable was an emergent artifact of the team's transdisciplinary experience.

These observations raise further questions. For example, how do they align with threshold concept theory? Is perspective-taking and other observed behaviour, a manifestation of transdisciplinary skill development? If so, can learning activities be introduced to further support this behaviour?

7 Conclusions and Recommended Next Steps

This paper suggests a meta-framework for developing transdisciplinary education that includes a framework for conceptualizing both transdisciplinary characteristics and the development of these characteristics. Using the design-based research methodology (DBR), the paper describes a transdisciplinary education case study, involving a week-long, project-based, sustainability design workshop, in which Masters-level students, trained in different disciplines at different universities in different countries, work together with local Valencian communities to create a conceptual design that aligns with sustainability. Students self-report improvements in their systems thinking, empathic thinking,

and metacognition and, more than other learning activities, identify discussions with teammates as contributing to these improvements. Faculty observe significant levels of student knowledge relating to transdisciplinarity, including systems thinking, empathic thinking, and metacognition. In the spirit of DBR, it is recommended that subsequent workshop iterations emphasize transdisciplinary pedagogies and raise student awareness of transdisciplinary skills via explicit activities aimed at developing systems thinking, empathic thinking, metacognition, and transdisciplinarity.

References

- Brownell, B. (2016) “Why Architecture School Needs Interdisciplinary Training”, *Architect: The Journal of the American Institute of Architects*, March 24, 2016.
- Byrne, E., Mullally, G. Sage, C. (2017) *Transdisciplinary Perspectives on Transitions to Sustainability*. Oxon: Routledge.
- Byrne, E.P., & Mullally, G. (2016) “Seeing beyond silos: Transdisciplinary approaches to education as a means of addressing sustainability issues”, Chpt 3 in *New Developments in Engineering Education for Sustainable Development*. (W. Leal Filho & S. Nesbit Eds.) Springer International.
- Derry, S. & Fischer, G. (2005) “Toward a Model and Theory for Transdisciplinary Graduate Education”, *American Education Research Association Annual Meeting*. Montreal Canada.
- Greenhalgh-Spencer, H., Frias, K., Ertas, A. (2017) “Transdisciplinary Content Pedagogy in Undergraduate Engineering Education: Being Pulled Up Short”, Chpt 6 in *Transdisciplinary Higher Education: A Theoretical Basis Revealed in Practice*. (P. Gibbs Ed.) Springer International.
- Ertas, A., Maxwell, T., Rainy, V.P., Tanik, M.M. (2003) “Transformation of Higher Education: The Transdisciplinary Approach in Engineering” *IEEE Transactions on Education*, 46(2), 289-296.
- Johnson, R.B., & Onwuegbuzie, A.J. (2004) “Mixed Methods Research: A Research Paradigm Whose Time Has Come”, *Educational Researcher*, 33(7), 14-26.
- Klein, J.T. (2014) “Discourses in transdisciplinarity: Looking Back to the Future” *Futures*, 63, 68-74.
- Lonngren, J., Ingerman, A., Svanstrom, M. (2016) “Avoid, Control, Succumb, or Balance: Engineering Students’ Approaches to a Wicked Sustainability Problem”, *Research in Science Education*, July, 1-27.
- McGregor, S. L. T. (2015) “Transdisciplinary Knowledge Creation”, Chpt 1 in *Transdisciplinary Professional Learning and Practice* (P. Gibbs ed.), Springer, London.
- McGregor, S. L. T. (2017) “Transdisciplinary Pedagogy in Higher Education: Transdisciplinary Learning, Learning Cycles, and Habits of Mind”, Chpt 1 in *Transdisciplinary Higher Education: A Theoretical Basis Reveals in Practice* (P. Gibbs ed.), Springer, London.
- Meyer, J.H.F., & Land, R. (2006) *Overcoming Barriers to Student Understanding: Threshold Concepts and Troublesome Knowledge*. Routledge, London DOI: 10.4324/978020396673

Mishra, P., Koehler, M., Henriksen, D. (2011) “The seven trans-disciplinary habits of mind: Extending the TPACK framework towards twenty-first century learning”, *Educational Technology*, 51(2), 22-28.

Morgan, D., Byrne, E., Nesbit, S., Ellis, N., Hemmes, K., Orozco-Messana, J. (2018) “Process, Improvisation, Holarchic Learning Loops, and all that Jazz: Experiences in Transdisciplinary Education for Sustainable Development“, *Proceedings of the 9th Conference on Engineering Education for Sustainable Development*, Rowan University, June 3-6., 253-261.

Nesbit, S., Ellis, N., Ostafichuk, P. (2017) “Working with “Others”: Developing Sustainability Skills in the First Year Engineering Classroom” *Proc. 2017 Canadian Engineering Education Association Conf.*, Toronto, Canada, June 4-7.

Oliveira, S. & Marco, E. (2017) “Preventing or inventing? Understanding the effects of non-prescriptive design briefs”, *International Journal of Technology and Design Education*, 27(4), 549 – 561.

O'Neill, D. K. (2012) “Designs that fly: What the history of aeronautics tells us about the future of design-based research in education”, *International Journal of Research & Method in Education*, 35, 119-140.

Payne, L. & Jesiek, B. (2018) “Enhancing Transdisciplinary Learning through Community-Based Design Projects: Results from a Mixed Methods Study”, *International Journal for Service Learning in Engineering, Humanitarian Engineering and Social Entrepreneurship*, 13(1), 1-52.

Ramaswami, A., Bettencourt, L., Clarens, A., Das, S., Fitzgerald, G., Irwin, E., Pataki, D., Pincetl, S., Seto, K., Waddell, P. (2018) “Sustainable Urban Systems: Articulating a Long-Term Convergence Research Agenda”, *American National Science Foundation-Supported Report by the Advisory Committee for Environmental Research and Education*.

Riley, D., Thatcher, C., Workman, E. (2006) “Developing and applying green building technology in an indigenous community: an engaged approach to sustainability education”, *International Journal of Sustainability in Higher Education*, 7(2), 142 – 157.

Tan, T., Nesbit, S., Ellis, N., Ostafichuk, P. (2018) “Crossing Boundaries: Developing Transdisciplinary Skills in Engineering Education”, *Proc. 2018 Canadian Engineering Education Association Conf.*, Vancouver, Canada, June 3-6.

Tejedor, G. & Segalas, J. (2018a) “Action research workshop for transdisciplinary sustainability science”, *Journal of Sustainability Science*, 13, 493-502.

Tejedor, G., Segalas, J., Rosas, M. (2018b) “Transdisciplinarity in higher education for sustainability: how discourses are approached in engineering education”, *Journal of Cleaner Production*, 175, 29-37.

Tembrevilla, G., Nesbit, S., Ellis, N., Ostafichuk, P., (2019) “Enhancing the Transdisciplinary Potential of First Year Engineering Students”, *Celebrating SoTL at UBC Conference*, University of British Columbia, October 23, 2019.

The Design-Based Research Collective. (2003) “Design-Based Research: An Emerging Paradigm for Educational Inquiry”, *Educational Researcher*, 32(1), 5-8.

Walther, J., Miller, S. E., Sochacka, N. W. (2017) “A Model of Empathy in Engineering as a Core Skill, Practice Orientation, and Professional Way of Being”, *Journal of Engineering Education*, 106(1), 123–148.

Welch, M., Sheridan, S.M., Wilson, B., Colton, D., Mayhew, J.C. (1996) “Site-Based Transdisciplinary Educational Partnerships: Development, Implementation, and Outcomes of a Collaborative Professional Preparation Program”, *Journal of Educational & Psychological Consultation*, 7(3), 223-230.

Mind-mapping for Interdisciplinary Sustainable Architecture

J. Orozco-Messana¹, J.M. Martinez-Rubio¹

¹Universitat Politecnica de Valencia (Spain)

jaormes@cst.upv.es

Abstract

Teaching Sustainability is a complex and demanding task requiring a multidisciplinary approach as is clearly demonstrated by the world focus on the UN Sustainable Development Goals (and specially goal 11: Make cities inclusive, safe, resilient and sustainable). The flipped classroom methodology facilitates the necessary discussion for embedding different points of view on the learning process. In this way students can effectively receive out-of-class and in-class opportunities to promote personal learning. However, structuring the huge amount of information handled is a very difficult tasks for students.

In order to develop students' learner autonomy or develop high-level thinking skills to achieve the learning competencies embedded on an Interdisciplinary Sustainable Architecture (ISA) curriculum, the use of mind-mapping learning strategy is known an effective knowledge construction tool for helping students' organizational thinking. Beyond this fact, many previous studies have considered peer assessment as an effective learning strategy to provide students with a teacher's perspective view to think and evaluate knowledge acquisition.

This research presents relevant results on the use of mind-maps with an online peer assessment approach. This tool is embedded as a key element for structuring Sustainability Assessment knowledge within a course based on the flipped teaching methodology. Moreover, an experiment has been conducted to evaluate the advantages and disadvantages of the proposed approach on students' learning analytics such as time involvement and learning reflections. It is important that educators use an online peer assessment learning environment for learners and aim for the goals to help learners become more critical, independent, and autonomous in the development of any Sustainability curriculum.

1. Introduction

Sustainability is a trending topic for our society. It involves many disciplines ranging from basic science to sociology and business, but always involving a technological approach when an architecture curriculum is involved. The purpose of ISA is not only the assessment of current or future cities, but also understanding how buildings and urbanism can contribute to more resilient societal organization in cities. In the twenty first century, the internet and the incipient Internet of things has allowed instant access to unfiltered, ubiquitous information which adds information analysis and its management as key disciplines for ISA development. Therefore, transversal competencies such as peer assessment and knowledge mapping have become important analysis and communication tools for future sustainability professionals. However, in the twenty first century globalization, Architecture curriculums are no longer just a collection of technical tools, but also a space which demands the integration of higher level competencies [1] for developing better organizational skills, creative (and critical) thinking, problem-solving abilities, or even more important team work. To face with such new environments and challenges, students' learning processes have to be

developed through team assessment and include strategies where faculty incorporate multidisciplinary knowledge in a critical environment.

Recent evidences [2] on the complex interaction between competencies development and oral interaction, indicate that flipping classrooms provides more time and interactive environment for teachers and students, and also helps students interact actively and improve speaking and writing skills [3]. The main reason is that by flipping classes students undergo a self-discovery process of learning materials, knowledge grounding leading to personal understanding and leaving all the time available in class for face-to-face instruction for oral team interaction for knowledge acquisition and final writing for memory development.

The classroom is a debate space for teacher-student communication and interaction, as well as group discussion, including peer evaluation [4]. However, Strayer [5] within flipped classrooms there is no proper guiding strategy, it is easy for students to feel frustrated about learning workload or unsuccessful flipping strategy.

Consequently, the development of the students' competency on identifying, defining and organize all relevant concepts within this environment appears as the natural solution for efficient knowledge acquisition. This technique Concept (or Mind) mapping, introduced by Noval and Gowin [6], facilitates active meaningful learning while developing a structure for all relevant information. In the past decade, classroom research [7] has demonstrated the advantage of active teaching for engaging students, followed by a mind-mapping strategy for a successful knowledge integration [8].

On the other hand, although previous studies have pointed out that concept or mind map learning strategies can help students to organize knowledge effectively, there is still the possibility of failure in mind-mapping learning strategy in university classrooms. Some key factors for failure are difficult to accept, the mind-mapping strategy of students themselves, and are unfamiliar with the way of thinking [9]. The result showed that mind mapping mainly benefited the students' writing in the elaboration dimension. Therefore, if the teacher could not only help the students using the mind-mapping tool to generate ideas in their writing process, but also integrate much more supportive guidance with teachers or peers, such as using peer assessment strategy to encourage peers to make reflections and improvements [17].

Due to the above reasons, it is necessary to develop a flipped teaching strategy based on group mind mapping, followed by peer assessment tools to assist students in summarizing, organizing concepts, and assessing others' work for an effective knowledge acquisition [18]. Thus, in this paper, a strategy is proposed for gaining meaningful insight on the mind mapping-based flipped classroom. Moreover, 3 consecutive years of classroom research have allowed a fair understanding of the advantages, and disadvantages, of first the flipped teaching approach, and second the proposed mind mapping approach, by answering the following questions:

1. Do students who learn with the integrated mind mapping-based flipped learning approach have significantly better learning achievement than the students learn without this strategy?
2. Do students who learn with the integrated mind mapping-based flipped learning approach have significantly better learning involvement than others?
3. Do students who learn with the integrated mind mapping-based flipped learning approach have significantly better learner autonomy than their peers?

2. Experimental plan and methodology

2.1. Reseach population implementation

The course on “Non Traditional Materials for Architecture” provides a relevant test bed for assessing students’ learning performance and perceptions due to its independence from the traditional curriculum (besides being optative) which gives the students, and faculty, more innovative opportunities. This course belongs to the Graduate degree in Building Engineering at Universitat Politecnica de Valencia (UPV) and is taught during the second semester of the last degree year. During the last three years the course has been taught, first on the traditional lecture based approach (course 2016-17), second following the Flipped Classroom methodology (course 2017-18), and on the last intake (course 2018-19) including for performance assessment the mind-mapping approach. Students are scored also on their learning styles to check any deviation due to a significant change on the student population.

The compared course evaluation taken from the corresponding syllabuses (table I) shows the main items evaluated on the different approaches all having the same weight on the final score. The course was taught by the same faculty all years.

Table 1. Nontraditional Materials in Architecture Course

Traditional	Flipped	Flipped+MindMaps
Lab practice	Lab practice	Lab practice
Class project	Class project	Class project
2 exams	Class exercises	Mind-maps

On the table the explanation for the evaluation items is explained on the next paragraphs:

- Lab practice: evaluation of the lab group solutions to exercises related to the lab work,
- Class project: team development of a proposed alternative solution to a building using nontraditional materials. The project develops all points introduced on the theory class applied to the practical case proposed. Besides the written document with all the details, the students make a joint executive presentation (5 minutes) of the project relevance.
- Exams: short questions to evaluation knowledge acquisition on the theory sessions of the course.
- Class exercises: individual solution of short numerical and logical questions for real cases.
- Mind-maps: individual mind-maps (using the e-tool Mindmup) presenting, and defining, all concepts presented in class in a connected graph. The students have to include relevant application examples from the Internet.

2.2. Students learning styles analysis

For statistical significance, it is agreed that experiments of different student populations are comparable when their learning styles can be considered as stable [14].

For evaluating the learning styles, the Felder-Soloman questionnaire [10] was used on all occasions. This decision was based on the adequacy of this test, according to Ruey-Shiang [11], for ensuring first a similar

type of student population each year, and second the right learning styles for good flipped teaching performance [12].

On table 2, the comparative learning styles per course are shown ensuring a relevant value (above 2) for one third of the population which gives a certainty of 95% for the hypothesis of equivalent populations according to ISO/TS 17503:2015 .

Table 2. Learning styles percentage of the students per course

Learning Style	Traditional course 2016-17	Flipped course 2017-18	Flipped+MindMaps course 2018-19
Active > 2	42	38	41
Intuitive > 2	39	46	45
Visual > 2	60	52	59
Global > 2	40	49	38

2.3. Methodology for the analysis

In order to evaluate the 3 proposed research questions, the corresponding output variables considered were:

1. Average of class performance score. This is the best evaluation we can obtained for the overall learning achievement.
2. Average of student satisfaction in the course. Under the research conditions learning involvement is directly connected to student satisfaction according to Narjaikaew [15]. The student satisfaction is measured at UPV by an individual (UPV controlled) survey.
3. Average of mind-map evaluation. Learner autonomy is especially relevant when their own creativity (individual concept-map evaluation) is measured [16].

3. Results and analysis

3.1. Experimental results

On table 3, the evaluation of the different items described on point 2.3 is presented for the course on each of the years considered for the research.

Table 3. Experimental results for the course each year

Indicator	Course 2016-17	Course 2017-18	Course 2018-19
Course average score ± std. dev.	6,3 ± 0,2	7,0 ± 0,1	8,1 ± 0,1
Average student satisfaction ± std. dev.	7,4 ± 0,4	8,1 ± 0,2	8,6 ± 0,1
Average individual score ± std. dev.	5,3 ± 0,3	5,8 ± 0,2	7,1 ± 0,1

3.2. Analysis of the research questions

From the results shown above, it is clear that the combination of flipped teaching and mind-map individual work is an excellent option for optative technical courses. After the introduction of flipped teaching relevant progress is evident as expected for the delivery of complex non-mathematically based disciplines [17]. Later enhancements due to individual mind-maps are especially relevant on multidisciplinary topics [18].

The student satisfaction develops a clear increase of results both as a group or individually which shows also a relevant increase in student autonomy. Additionally, the smaller standard deviation indicates that the conclusions are more representative for the group.

4. Discussion

From the evidence presented on this paper, a simple path to deliver effectively sustainability competences has been introduced. Flipped teaching has been proved here as a very effective methodology for scientific topics with low mathematical burden, as well as the use of mind-maps for structuring multidisciplinary disciplines. The procedure can be easily extrapolated to other fields where the multidisciplinary approach is a key element of the message.

5. Conclusions

Although there has been considerable progress in the incorporation of Sustainable Cities into the curricula of higher education institutions (HEIs) in Europe, particularly on competences for sustainable development and on pedagogical approaches, there has been limited research on the connection between how courses are delivered (pedagogical approaches) and how they may affect sustainability competences.

This paper has presented the results from an academic research into the best delivery practice for Sustainability through flipped teaching and mind maps. The acquisition of sustainability competences, and the related pedagogical approaches, are key to achieve sustainability. It is also relevant to take note of the increased work load by faculty in charge.

Follow-up research, could provide insights on how to better use, rethink, redesign, and combine these with other pedagogical approaches to provide a more sustainability-oriented education.

6. Acknowledgments

This research has been co-funded by the Erasmus+ KA2 program of the European Union under the “PETRA” project.

References

1. Fuertes-Camacho, M.T.; Graell-Martín, M.; Fuentes-Loss, M.; Balaguer-Fàbregas, M.C. Integrating Sustainability into Higher Education Curricula through the Project Method, a Global Learning Strategy. *Sustainability* 2019, 11, 767.

2. Gallego-Álvarez, I.; Lozano, M.B.; Rodríguez-Rosa, M. Analysis of Social Sustainability Information in a Global Context According to the New Global Reporting Initiative 400 Social Standards. *Sustainability* 2019, 11, 7073.
3. Zainuddin, Z., Zhang, Y., Li, X., Chu, S., Idris, S. and Keumala, C. (2019), "Research trends in flipped classroom empirical evidence from 2017 to 2018: A content analysis", *Interactive Technology and Smart Education*, Vol. 16 No. 3, pp. 255-277.
4. Sams, A., & Bergmann, J. (2013). Flip your students' learning. *Educational Leadership*, 7, 16-20.
5. Wilson, D. Exploring the Intersection between Engineering and Sustainability Education. *Sustainability* 2019, 11, 3134.
6. Novak, J.D.; Gowin, D.B. *Learning how to learn*; (1984) Cambridge University Press.
7. Kerrigan, J. Active Learning Strategies for the Maths Classroom, *College Teaching* (2018), 66:1, 35-36.
8. Hwang, G.J., Shi, Y.R., Chu, H.C. A concept map approach to developing collaborative Mindtools for context-aware ubiquitous learning. *British Journal of Educational Technology* (2011), 42, 5, 778-789.
9. Felder, R. M., Soloman, B. A. (1999). Index of learning styles questionnaire. Available online: URL: (accessed on 3 December 2019) <https://www.webtools.ncsu.edu/learningstyles/>; https://www.researchgate.net/publication/228403640_Index_of_Learning_Styles_Questionnaire.
10. Ruey-Shiang S. The Learning Performance of Different Knowledge Map Construction Methods and Learning Styles Moderation for Programming Language Learning (2019). *Journal of Educational Computing Research*, 56, 8, 1407-1429.
11. OECD 2017. *The OECD Handbook for Innovative Learning Environments*. OECD, Publishing, Paris.
12. Moyer, J.C., Cai, J., Wang, N., & Nie, B. (2011). Impact of curriculum reform: Evidence of change in classroom practice in the United States. *International Journal of Educational Research*, 50, 87-99.
13. Samsudin, D.; Hardini, T. The influence of learning styles and metacognitive skills on students' critical thinking in the context of student creativity program. *International Journal of Education* 11, 2, 117-124.
14. Narjaikaew, P., Emerat, N., Arayathanitkul, K., & Cowie, B. (2010). Magnetism teaching sequences based on an inductive approach for first-year thai university science students. *International Journal of Science and Mathematics Education*, 8, 891-910.
15. Sejpal, K. (2013). Models of teaching: the way of learning. *International Journal of Research in Humanities & Social Sciences*, 2, 18-24.

16. Suh, H.; Han, S. Promoting Sustainability in University Classrooms Using a STEM Project with Mathematical Modeling. *Sustainability* 2019, 11, 3080. Gray, S.; Sterling, E.J.; Aminpour, P.; Goralnik, L.; Singer, A.; Wei, C.; Akabas, S.; Jordan, R.C.; Giabbanelli, P.J.; Hodbod, J.; Betley, E.; Norris, P. Assessing (Social-Ecological) Systems Thinking by Evaluating Cognitive Maps. *Sustainability* 2019, 11, 5753.
17. Colaux, C., Beckers, Y., Brostaux, Y., Charles, C., Claessens, C., Heinesch, B., Sindic, M., Degré, A. Soft Skills: how to make the young engineers aware of their new talents?. *Proceedings EESD2018*.
18. Jensen, C.D. Piloting the flight, a systems methodology for sustainability education. *Proceedings EESD2018*.

Crossing technical and non-technical skills: French case study of ecodesign in engineering education

C.Perpignan¹, Y.Baouch¹, V.Robin², B.Eynard¹

¹Roverval laboratory, Université de Technologie de Compiègne, France

²IMS laboratory, Université de Bordeaux, France

catherine.perpignan@utc.fr

Abstract

Nowadays, to deal correctly with sustainable issues, future engineers must have the ability to use non-technical skills. In order to evaluate all interactions and all possible solutions, a systemic vision of problematics should be adopted. We wanted to demonstrate the possibility of integrating all these non-technical competencies in a disciplinary training. For this reason, we developed some examples of activities to provide support to teachers and we proposed a skills and knowledge model to support teachers increasing their own educational.

This model was tested to bachelor engineering students. We suggested them an eco-design problem-based learning activity. Objectives of this case study are to identify which type of skill mix was addressed by students and compared them with levels defined in the model. It's also the opportunity to assess how associations are made between these two kinds of competencies

The paper presents results of our case study. Including improvements needed in our competencies model. Some future work will be drawn at the concluding section to propose the next of our research for integrating sustainable competencies into engineering curricula.

1 Introduction

1.1 Global context

Nowadays, more and more students feel a lack of teaching development for sustainability topics in their curriculum. In French engineering schools or universities most of training courses do not answer to this challenge because they modestly include the question of sustainability in their curricula. Thus, according to the Shift Project (a French think tank) report (Vorreux *et al.*, 2020), environmental questions are mentioned in 56% of French engineering courses but in 71% of those cases, the courses are attended at a master level, and “these new degrees have become very specific, with a high level of specialization and a reduced scope.” (Felgueiras *et al.*, 2017). However, sustainable development is a major preoccupation for each of us. So, students express more and more a special interest on environmental transition problems. In 2018, students from different French engineering schools wrote a Manifesto for a wake up on the environment. The Manifesto¹ has been signed by 30,883 students (from universities and engineering schools). They wanted to highlight that: “As we get closer to our first job, we realize that the system we are part of steers us towards positions that are often incompatible with the result of our reflections. This system traps us in daily contradictions”. Thus, new graduates search to integrate companies which share same values on sustainability as them. At the same time, these companies meet new challenges driven by politics

¹ Manifeste étudiant pour un réveil écologique. 2018. <https://pour-un-reveil-ecologique.fr/>.

(standards and regulations) and customer expectations (Hanning *et al.*, 2012). So, integrating sustainable competencies into engineering curricula has becoming one of the main challenges since few years in French education system but also an industry's need which are looking for trained engineers who can answer to these questions.

1.2 Sustainability in Engineering Education

For several years, the question the integration of sustainable development in higher education is discussed. Our research work focuses on engineering education in France and the main issue comes from nature of competencies and skills to achieve. The question arises how can be improved the integration of basics of sustainable engineering in trainings rooted in technical knowledge. In previous work, we have identified that engineer's skills are obviously necessary but it is also important to develop cross skills to train student in a sustainable engineering way (Perpignan *et al.*, 2019). Developing such curricula is often complicated because education system always lays on knowledge transmission while today knowledge must be integrated into competencies-based framework. This term of competency is easily misinterpreted and in the educational literature competence have a polysemic sense (Joannert *et al.*, 2015). Teachers often develop curricula that are addition of courses and obtain a patchwork of not linked competencies and knowledge. Indeed, they are specialists on specific technical area and working with a competencies-based framework means to solve complex tasks in a multidisciplinary context supported by cross skills. So, in our research work we have chosen to use the OECD definition: "competence involves the mobilization of knowledge, skills, attitudes and values to meet complex demands". It means that knowledge, skills and attitudes & values must be interlinked. Thus, to achieve sustainable engineering, working with a competency framework is essential. "These types of problems [...] require students to acquire an integrated set of problem-solving skills or competencies, far more than a body of knowledge" (Wiek and Kay, 2015). Based on this literature review, we have retained two recommendations. The first is that sustainable engineering training must be progressive and it must be based on holistic vision of sustainability during secondary school, undergraduate and master's training. The second is that sustainable engineering training must always contains knowledge, skills and values. So, according to this postulate our goal research is to propose a competency framework which could be integrated into engineering curricula in order to complete student's training.

In this paper, we will identify what kind of competencies must be outlined in a sustainable engineering competency framework and how is it possible to integrate them in an engineering curriculum. The aim is to propose a sustainable engineering based-competences pathway and to describe and analyze an experimental situation based on those two hypotheses.

2 Toward a sustainable competency framework

2.1 Competencies for sustainable engineering

Many researchers have written about the necessity to acquire key cross-disciplinary competencies to answer to the global issue of sustainability. All these authors have in common to highlight communicative competence, interdisciplinarity and a more global vision of the issues with system or systemic thinking methodology (De Haan, 2006; Barth *et al.*, 2007; Segalas *et al.*, 2009; Wiek *et al.*, 2011; Quelhas *et al.*, 2019). But student engineers have also specific competencies to achieve established by some

organization like ABET² in US or ENAEE³ in Europe. These organizations edited specific engineer’s skills such as: engineering design, engineering analysis... Question is: how can we cross all these competencies in order to train engineers who will contribute to sustainable development effectively?

In a previous work we have proposed an analysis of these skills. We have tried to evaluate if links exist between engineering skills as defined by ENAEE and cross-disciplinary skills (Perpignan *et al.*, 2020). This work allows to show that some engineering skills and cross skills are naturally interconnected. For example, “solve a complex problem” can be both an engineer’s skill and a cross one. That’s why it will be easier for this competency to integrate it in an engineer’s training. On the other hand, competencies like critical thinking or systemic thinking are more abstracts for teachers. So, it’s necessary to describe them more precisely and to propose some in case situation in order to understand what is expected.

Table 1: Cross skills and engineering skills (Perpignan *et al.*, 2020).

Engineering skills	Cross-disciplinary skills							
	Critical thinking	Collaboration	Solve a complex problem	Systemic thinking	Normative competence	Self-knowledge	Anticipatory	Strategic competence
Fundamental Scientific Knowledge	✓		✓	✓				
Engineering Analysis	✓	✓	✓	✓	✓	✓		
Engineering Design		✓	✓	✓	✓	✓	✓	
Investigations	✓		✓	✓	✓	✓		
Engineering Practice	✓	✓	✓	✓	✓	✓	✓	✓
Making Judgements	✓	✓	✓	✓	✓		✓	✓
Communication and Team-working		✓	✓		✓			✓
Lifelong Learning	✓		✓	✓	✓	✓	✓	✓

Objective was to use these links and to propose structured training modules in a global curriculum allowing at the same time the development of competencies and knowledge. Based on this work of skill’s identification and on the rise of competence-based education in universities and higher education, we propose to work with a competency approach in order to create a competency framework including sustainability into curricula.

2.2 Methodology to develop a sustainable competence-base program

Competencies approach “should reflect the skills and knowledge that students will need at the next stages of their development [...]. The process for developing program-level competency definitions should be iterative, evolving to incorporate marketplace demands, academic expectations, and student needs” (Johnstone and Soares, 2014). So, to achieve cross disciplinary skills and engineering skills, we must organize our training path and we have chosen to refer to (Poumay and Georges, 2017) who have proposed a methodology to develop a competence-based program. This methodology consists of six principles:

² ABET : Accreditation Board for Engineering and Technology

³ ENAEE : European Network for Accreditation of Engineering Education

1. Using real professional situation and active learning
2. Flexibilising the training
3. Choosing useful resources to develop skills
4. Fostering learning through collaboration
5. Allow reinvestment of skills already mobilized
6. Assess the level of skill's acquisition

In following this methodology, we have developed a competence-based model which is represented in Figure 1. Competence is "a complex know-how based on the mobilization and combination of knowledge, skills, attitudes and external resources applied in specific families of situations" (Tardif, 2006). According to this definition, we have identified 5 types of situations where an engineer could be called upon to mobilize skills within the framework of sustainable engineering. These families correspond to blocks because in the French educational system, the concept of competences' block was introduced by law n° 2014-288 of March 5, 2014 relating to vocational training for employment and social democracy. This concept of block allows to personalize the training courses and to adapt to the needs of the learners. Thus, blocks were defined to build a path-curriculum for engineering education (Figure 1).

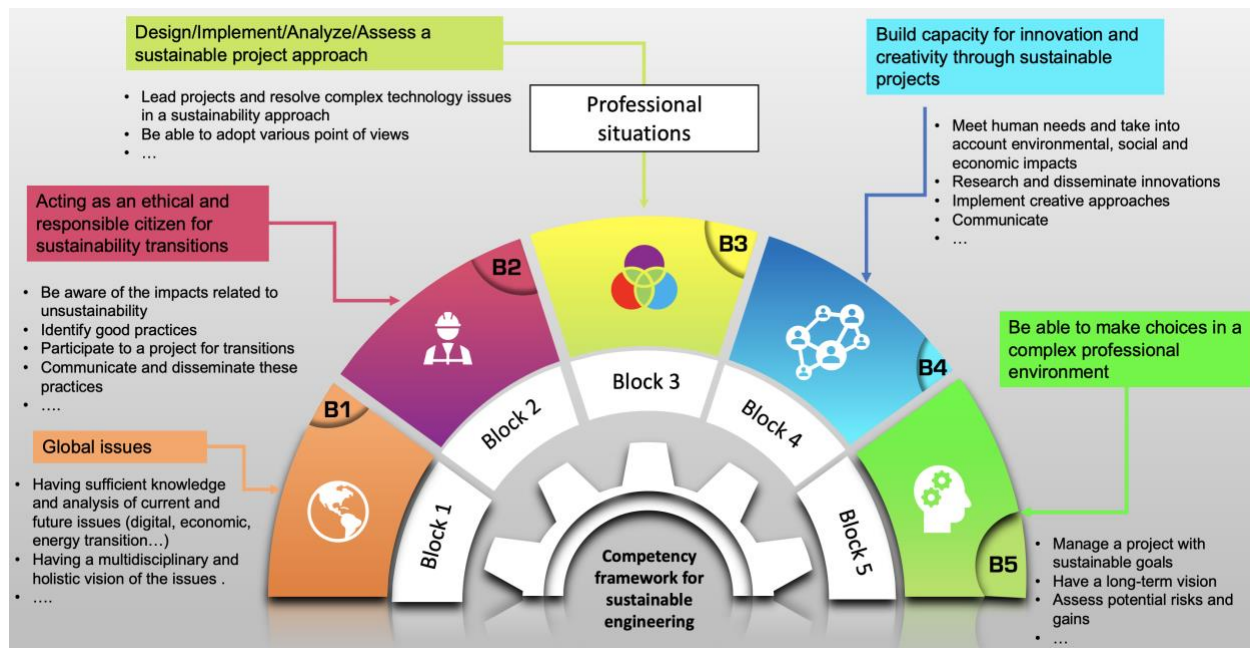

Figure 1. Model of a competency framework to achieve sustainable engineering

All these blocks will be always present during the student curriculum but according his level they could be adapted. Moreover, each block will consist in sub-competencies. Indeed, "Each institution and faculty have their own view and interpretation of sustainability engineering and its application in their educational program" (Sharma et al., 2017). This proposition gives some common basis on sustainability which are essential to take into account all issues but we keep a margin of freedom to allow teachers to develop modules which consider their specificities. Future engineers must acquire all or part of these competence-based model but they also must continue to improve their level of acquisition during their job life. It means also that during all this path, teacher must assess the level of acquisition of skills. To define some steps, we use the scale established by (Dreyfus and Dreyfus, 1980). In this scale, a student goes through five

successive levels: novice, beginner, competent, proficient and expert. Three first levels can be achieved during initial education and the last ones in a professional context. That's why lifelong learning has a more and more important place in engineer's careers. Blocks B1 and B2 correspond to concepts, values, behaviors, etc. which are the "basis of sustainability" from primary school to university. The block B3 completes B1 and B2 by providing a more technical, operational and contextualized vision of sustainability. This block will be "customized" by teachers depending on training objectives and students' target occupations during students' undergraduate years. It is advised for teachers to develop relevant and close to reality professional situations in this block since it is the more operational one. In such training situations, students will use previous skills and knowledges that they have acquired. Teachers can focus on technical aspects but keep a look on transversal skills that students must to deepen. Block B4 concerns the development of some students' soft skills as capacity of innovation or creativity. B4 allows students to reinvest knowledge and competencies of blocks B1, B2 and B3 in a personal or training project in university/engineering school. Block B5 regroups necessary competencies to put in practice all the other blocks. It can only be really complete during a real professional situation. It is the block in which students to achieve the "proficient" and "expert" levels of the competency framework. "Proficient" level can eventually be achieved during the final diploma's internship and "expert" level is achieved during lifelong learning.

3 A case study: eco-design training for novice technological teachers

3.1 Scope

To test our sustainable engineering competency-based framework, an eco-design training was proposed to future engineering science teachers. Indeed, they must acquire a first level of knowledge in eco-design. So according to our scale it means that they must achieve a beginner level for eco-design skills but we can target a competent level for cross disciplinary skills. Thus, our case study belongs to block 3, it's for bachelor's students who have some knowledges on sustainability and who followed a previous engineering training but some competencies belonging to block 1 and 2 will be also necessary. We have chosen a problem-based learning session. Indeed, problem base learning activity includes knowledge acquisition, collaboration and communication in a real context. "These skills are encompassed by the pedagogy of problem-based learning (PBL), which provides students with opportunities to learn to think, specifically "how to think" rather than "what to think," and potentially within the framework of sustainability (Thomas, 2009)". The aim of these activities is to test our model and to validate if students use cross skills during the learning activity. That's why we suggest our students the following problem: "Bottle or gourd?"

The professional situation of this session was: "Assess eco-design maturity degree of an existing product". Some cross skills are targeted, as our students have already an engineer background, beginner level could be easily considered. The aim of this activity is to work on critical thinking, systemic thinking, solve a complex problem and self-knowledge for cross skills. At the same moment, students will work on knowledge and understanding, engineering analysis, investigations and making judgements for engineer's skills.

The session consists in 3 activities and the objective is to start from a technician Eco-designer vision (it means using an eco-design tool) to progressively open the scope to a more global vision which will drive students towards more cross skills and values:

- Activity 1: objective is to use an eco-design tool to determinate which bottle has the biggest environmental impact. This activity doesn't really highlight cross disciplinary skills but engineering skills are very strong. It's a traditional approach concerning eco-design problem. At the end of this activity we can begin to check what kind of questions students have answered and if these questions are only technical or if some of them have wider questions.
- Activity 2 is more ambiguous. Indeed, we will oblige students to think about the choice of the bottle they have made during the previous activity. We want them to propose some improvements in order to reduce the environmental impact, but their reflections must not be limited to a material choice. So, activity 2 is a first mix of cross disciplinary skills and engineering skills.
- Activity 3 is principally focus on cross disciplinary skills. Students must think about the necessity of a bottle to drink. So, for example some subjects as water pollution or health consideration could be evocated.

3.2 Identification and description of competencies

In this organization, we can see that we have interlinked cross skills and engineer's skills. Some would be addressed several times in order to deepen their acquisition. Main difficulties for teacher in this kind of organization is to define precisely what means for example critical thinking or solve a complex problem. These skills are so fuzzy and not really teachable. Thus, we have to define some descriptors that will permit to identify if students use their soft skills in order to analyze a situation or solve a problem. For example, critical thinking must be very difficult for teacher to assess in training curricula. Thus, Robert H. Ennis defines critical thinking as a *“reflective and reasonable thinking that is focused on deciding what to believe or do”* (Ennis, 1985). We need to translate this definition into some comprehensive descriptors which could be used in a teaching situation (Sanchez et al., 2006). The Dreyfus's scale was used in order to define a progressive way to develop critical thinking. Thus, four levels could be identified associated to the four level of acquisition. Figure 2 describes these levels. In our study case we target the competent level.

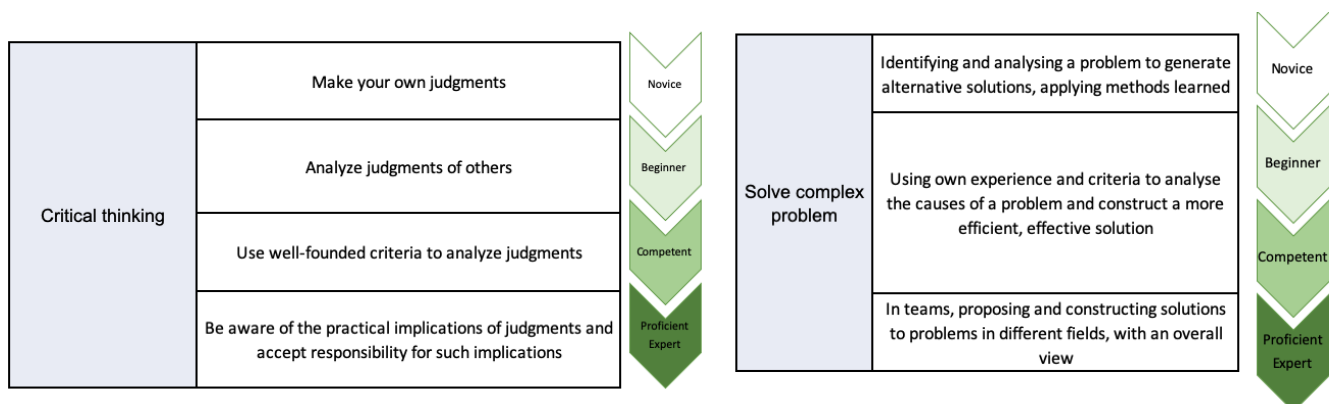

Figure 2. Description of critical thinking and solve a complex problem and level of acquisition

3.3 Skills development grid

In order to help teachers to be aware of soft skills integration in their learning activity a grid was established (Figure 3). Thanks to this grid, teachers and students can identify which skills are requested to answer to the professional situation. To complete this grid, teachers must be aware of select both engineer's skill and cross skills, they also consider that Block 1 and Block 2 could be resources which can support their learning activity. This grid can also be used to check if students have really achieved the target level.

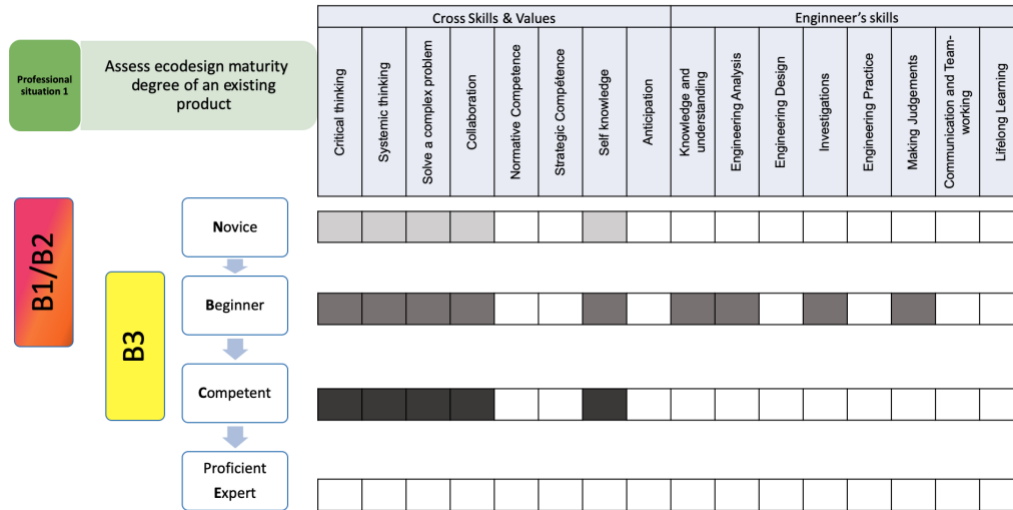

Figure 3. Skills development Grid

4 Discussion et perspectives

Our framework model is still in progress, we have just begun our test with a student group and we have to verify if we address correctly skills that we have chosen for activities. We can present our results during oral session. In our future work, we have to test our competency-based framework in others professional situations with different student groups in order to check if we assess all cross skills. We have also to think if this grid can integrate a portfolio for students which allow to follow their capacity to acquire this kind of competencies.

5 References

- Barth, M., Godemann, J., Rieckmann, M., & Stoltenberg, U. 2007. Developing key competencies for sustainable development in higher education. *International Journal of Sustainability in Higher Education*, 8(4), 416–430
- De Haan, G. 2006. The BLK '21' programme in Germany: A 'Gestaltungskompetenz'-based model for Education for Sustainable Development. *Environmental Education Research*, 12(1), 2006, 19–32
- Dreyfus, S. E., & Dreyfus, H. L. 1980. *A five-stage model of the mental activities involved in directed skill acquisition* (No. ORC-80-2). California Univ Berkeley Operations Research Center.
- Ennis, R.H. 1985. A logical basis for measuring critical thinking skills. *Educational Leadership*, p. 45

- Felgueiras, Manuel C., João S. Rocha, and Nídia Caetano. 2017. Engineering Education towards Sustainability. *Energy Procedia*, 4th ICEER 2017
- Hanning, A., Priem Abelson, A., Lundqvist, U., & Svanström, M. 2012. Are we educating engineers for sustainability? *International Journal of Sustainability in Higher Education*, **13(3)**, 305–320.
- Johnstone S.M, Soares L. (2014) Principles for Developing Competency-Based Education Programs, Change: The Magazine of Higher Learning, 46:2, 12-19,
- Jonnaert, P., Ayotte-Beaudet, J. P., Benazo, S., Joëlle, S., & Furtuna, C. D. 2015. Vers une reproblématisation de la notion de compétence. Chaire UNESCO de développement circulaire, Cahier 34
- Quelhas, O. L. G., Lima, G. B. A., Ludolf, N. V. E., Meiriño, M. J., Abreu, C., Anholon, R., Rodrigues, L. S. G. 2019. Engineering education and the development of competencies for sustainability. *International Journal of Sustainability in Higher Education*
- Perpignan, C., Robin, V., Baouch, Y., & Eynard, B. 2019. Ecodesign from High School to Bachelor Level: A French Case Study. In: 22nd ICED, Aug. 5-8, Delft, The Netherlands
- Perpignan, C., Robin, V., Baouch, Y., & Eynard, B. 2020. Engineering Education perspective for sustainable development: a maturity assessment of cross-disciplinary and advanced technical skills in eco-design. In. 27th CIRP LCE, May 13-15, Grenoble, France
- Poumay, M., Georges, F. 2017. Des balises méthodologiques pour construire un référentiel de compétences et une grille de programme. *Organiser la formation à partir des compétences. Un pari gagnant pour l'apprentissage dans le supérieur*, 39-62.
- Sánchez, A. V., Poblete, M., & Eds, R. 2006. Competence Based Learning. In *Bulletin of University of Agricultural Sciences and Veterinary Medicine Cluj-Napoca - Horticulture* (Vol. 63).
- Segalàs, J., Mulder, K. F., & Ferrer-Balas, D. 2012. What do EESD “experts” think sustainability is? Which pedagogy is suitable to learn it?: Results from interviews and Cmaps analysis gathered at EESD 2008. *International Journal of Sustainability in Higher Education*, **13(3)**, 293–304
- Sharma, B., Steward, B., Ong, S. K., & Miguez, F. E. 2017. Evaluation of teaching approach and student learning in a multidisciplinary sustainable engineering course. *Journal of Cleaner Production*, *142*, 4032–4040.
- Tardif, J., 2006. L'évaluation des compétences. Documenter le parcours de développement. Chenelière Éducation, Montreal.
- Thomas, I. 2009. Critical thinking, transformative learning, sustainable education, and problem-based learning in universities. *Journal of Transformative Education*, **7(3)**, 245-264.
- Vorreux, C., Berthault M., & Renaudin, A. 2020. Mobiliser l'enseignement supérieur pour le climat, former les étudiants pour décarboner la société. <https://theshiftproject.org/>
- Wiek, A., Withycombe, L., & Redman, C. L. 2011. Key competencies in sustainability: A reference framework for academic program development. *Sustainability Science*, **6(2)**, 203–218.
- Wiek, A., & Kay, B. 2015. Learning while transforming: Solution-oriented learning for urban sustainability in Phoenix, Arizona. *Current Opinion in Environmental Sustainability*, **16**, 29–36.

Higher Education Approaches to Engender Students' Environmental Consciousness in Electronic Device Design

Dr. Sivakumar Ramachandran¹

¹Institute of Art, Design and Technology, Dun Laoghaire, County Dublin, Republic of Ireland

s.ramachandran@iadt.ie

Abstract

Design briefs defined by user groups and their development into prototypes or demonstrators follows well established methodologies in both academia and industry. However, the infusion of an environmental context is yet to be fully established. It is critically important that this objective is achieved, so that the products developed promote positive environmental sustenance, follow processes that identify materials that are sourced from the most ecologically appropriate sources, follow a design methodology that leads to a set of candidate solutions that are all in one way or another environmentally sound, and finally the inclusion of an 'end of life' path which directly identifies re-usability or safe biodegradability.

This paper surveys the approaches Higher Education Institutions have taken in embedding environmentally conscious design tools, particularly related to electronics, into their students' curricula, and an informal audit as to how well their approaches engender sustainability of engineering and design consciousness in their graduates.

The paper draws on engineering, design, creativity, materials selection, innovation, product and industrial design in relation to electronics, in an otherwise broad sense. The paper also highlights examples of this approach at the Institute of Art, Design and Technology, Dun Laoghaire, within the Irish context of environmental policy.

1 Introduction

In this era of climate change and dwindling sources of both materials and energy, the nature of engineering is shifting to one based around conservation. The needs of protecting the environment and improving it are fast replacing individual or collective needs of users, based solely on themselves. In the area of electronics, there is some movement towards the appreciation that the sourcing of materials, development of processes, use of energy and manifestation of byproducts needs to be curbed in this age of insatiable data content. The chemicals and energy needed to synthesise and operate such equipment further adds to pollution and heating of the atmosphere. For instance, the development of data centres, with the computer manufacturing processes involved and high levels of energy expended as heat, raises questions on consumption and processes.

Electronic Engineering since its inception has relied on the application of scientific processes to extract and process resources in the main which are not naturally occurring. In addition, the enclosures for the products developed use materials that have been specific to support the electronics therein. Traditional engineering education in this area has focused on solutions that maintain the operation of such products, with the main considerations as regards environmental effects being electrical safety of the users or the public. Whilst

these aspects are very important, a growing awareness over the last quarter of a century is the fact that electronics manufacture in the complete process lifecycle can affect the environment detrimentally, in both the consumption of resources and the bi-products of the manufacturing and operational processes. In a wider sense, electronic systems function and maintenance maybe in conflict with the natural functioning and sustainability of the environment. The scope of influence and the assumptions made in development need to encompass a view as wide as possible. Indeed, it is fast becoming a social and ethical requirement to consider develop on this basis. Coupled with these technologies, is the desire to transmit data by high-speed wireless links, for instance the emerging 5G networks. There are concerns about the health effects of these high frequency communications links, effects on wildlife and the amount of atmospheric heating. Whilst these concerns may be unfounded, a more responsible and objective approach needs to be taken, with environmental sustainability firmly in mind before such schemes can be satisfactorily commissioned. Such an approach involves the foresight that can only be obtained through third and fourth level higher education.

Hence in higher education at both third and fourth level, students need to be not only aware of the need for developing sustainable electronic designs, but they need to develop tools to do so. Students should also debate the issues surrounding sustainability and the perceived effects of electronic equipment on climate change. Whilst there may be disagreement as to the whether such effects are taking place or their causes, it should be realised that many of their future employers not only do believe in the need to mitigate what they see as harmful effects on the environment, but also are investing heavily in resources, equipment and jobs to achieve this, with an expectation that their employees share the same vision. A spectrum of political, ethical and social perspectives comes to bear on the debate, with students having a clear idea of where they personally stand and the justified use of development tools.

Furthermore, the contribution of engineers to the fulfilment of sustainability is of course only one perspective. There is a spectrum of disciplinary contribution to this goal, for instance in business, psychology, social science, politics, art and media. The problem-solving skills gained by engineers in their education are not without parallels in these other disciplines. The communication through art and media of the importance of developing a sustainable planet is vital to galvanise action. These communication methods in themselves also needs engineers or engineering principles in their implementation.

With these broad considerations in mind, this paper sets out to gauge the progress in electronic engineering education with respect to planetary sustainability, and highlight particular initiatives in this area, within a cross disciplinary context such at the Institute of Art, Design and Technology, Dun Laoghaire, Ireland.

2 Survey of Programmes Incorporating Sustainability in Electronic Engineering

There are very few specific initiatives related to sustainability in electronics engineering education. The case has not been substantiated in this sub-sector. In the main, the closest match to such higher education engineering programmes are ones quite rightly related to energy management and sustainable electrical

power generation. There are also programmes which develop students' competences around civil and mechanical engineering infrastructure for electrical energy generation.

A comprehensive approach in the electronics sub-sector arises in the Nigerian polytechnic programmes (Mukhtar & Saud, 2019) and education to support sustainable electronic design in infrastructural electric power control, amongst other applications. In many cases electrical engineering programmes with sustainability included in their curricula are concerned with educating students to design power generation systems from renewable sources and civil engineering structures to match. Rochester Institute of Technology, USA has considered the aesthetics of sustainability in electronics, by including design processes to add a personal attachment dimension to an electronic product, whilst making it sustainable (Lobos & Babbitt, 2013). This approach is welcome, as the promotion of an emotional attachment within a product design will engender a change in lifestyle towards a more sustainably aware one. The University of British Columbia has embedded a sustainability theme in its electronic engineering programmes, with specific sustainability projects for students to learn through participation (Satti, 2018).

Much teaching and learning research into sustainable engineering effectiveness has involved examining methodologies and approaches. A specific example in the electronics sub-sector was conducted at California State University. A sustainability approach to electronic engineering laboratory work was developed, whereby students assess the environmental impact of every procedural stage of their experimentation and project work, through student self-reflection (Braun, 2010).

In the wider arena of engineering and sustainability, there are examples of methodological analysis of degree programmes in North America and Northern Europe. Researchers at Iowa State University recognises the broader themes of social, economic and environmental aspects in every engineering sub-sector and related area. They have developed tools to assess the teaching structures of such programmes, including the evaluation of using the Life Cycle Assessment (LCA) approach in design (Sharma *et al*, 2017).

An international group of researchers from North America/Northern Europe has evaluated the learning outcomes of sustainable engineering programmes, within the framework of the Tbilisi and Barcelona accords, the structure that all such higher education teaching should align with (Swanström *et al*, 2008). Researchers at Aalborg University in Denmark have assessed whether universities which offer sustainable engineering programmes, themselves work and promote sustainability at their campuses (Christansen *et al*, 2008). The paper finds that such a complimentary campus approach is most evident where a university offers a significant suite of engineering programmes in which sustainability is embedded, which implies that sustainability is more than just an addition to an existing teaching structure, it is a holistic philosophy within which such student opportunities can successful reside. The Technical University of Delft, Netherlands and the KTH Royal Institute of Technology, Stockholm, Sweden are two notable European examples of such a proactive campus-wide approach.

The National Strategy on Education for Sustainable Development in Ireland, 2014-2020 (Department of Education and Skills, 2014) does not specifically identify engineering in its policy, but does advocate a cross-disciplinary approach to sustainability at third/fourth level education and research domains.

The survey of electronics engineering related higher education worldwide, lead to an understanding that the embedding of sustainability principles into electronics engineering programmes would not be dissimilar to those in other sub-disciplines. Furthermore, in a cross-disciplinary environment, it is more about fostering attitudes, debate, habits and mindsets, without indoctrination political or otherwise. Knowledge of electronics technologies and their competent use is vital, however the responsible implementation in a sustainable context is the overlaying feature that allows students to choose the best projects to undertake based on these principles, as well as the staff in higher education to develop and foster research which contributes to sustainability or at the very least are neutral in their effects.

3 The Electronics for Sustainable Design (ESD) module at the IADT Dun Laoghaire

The author of this paper developed and delivered a new module to second year students at the Institute of Art, Design and Technology (IADT), Dun Laoghaire, Ireland, in January 2020. The module was an elective, offered to students in the Faculty of Film, Art and Creative Technologies (FACT), except those students already taking modules in electronics and engineering. Most of the students who took the module were from the Bachelor of Arts (Honours) programme. Students from this programme would be sourcing materials from different places such as recreate.ie, a storage facility for recycled or unused items, together with advisers on best use. Whilst as yet there is no specific strategic element to fostering programmes in sustainability at IADT, it is apparent from observing students' attitude towards their work, that there is a growing number who consciously have an ethos in using recycled elements in their installations, over and above the need to reduce costs.

In addition, students' interest included the gaining skills in electrical and electronics design and manufacture within an engineering context, that could be used in art projects, be it for example painting, sculpture, collage or a mixed media combination of such specialisms. A typical, basic example would be if a student wanted to incorporate audio-video aspects and need sensors and actuators to trigger the sources. A basic understanding of electronics as a springboard would satisfy their needs in this respect. In the context of sustainability, students wanted to know how they could take electrical and electronic components from re-cyclable equipment and use them in projects, in safe, orderly and design conscious manner.

A small number of students also enrolled from the 3D Design, Applied Psychology and Creative Computing programmes. Such is the eclectic mix of degrees at IADT that students' project work inevitably crosses over quite naturally between several disciplines.

The aim of the module was for small groups of students to use engineering principles to produce an artefact incorporating electrical or electronic components, which either improved sustainability or at least did not add to the carbon footprint significantly. The artefact had to be made using recycled materials and components only, where possible avoiding bought electrical and electronic components, plastics and chemical glues. Within the overall design process, the artefact's life cycle and re-use migration path had to be clearly identified as sustainable. It was possible that the students could produce an artefact that demonstrated the concept of a product that could improve sustainability, rather than the actual working model. It was made very clear from the beginning that sustainability should not be sacrificed over the aesthetics of the artefact. Thus, sustainable functionality was made primary motivation.

The output from the three-week module was for the team to produce an artefact and illustrated poster. As individuals the students had to produce comprehensive sketchbooks based on their own contribution to the project and learning experience in the module. Throughout students' written and oral communications, and subsequent actions, students were expected to converse in the language of sustainability and make all decisions primarily with this in mind.

Several workshops and field trips were arranged, in an order that best matched the author's experience in running such modules to predict students' needs at a particular of their work. The order is as below:

- Sustainability discussion session
- Workshop on the sustainable design cycle within a user needs context
- Sketching technique session
- Visit to sustainability themed exhibitions at art and science galleries
- General health and safety
- Electronics prototyping workshop
- Electronics manufacturing workshop
- Visit to IADT's workshops and digital fabrication laboratory
- Visit to tog.ie, a Dublin based maker space for creative electronics and arts projects
- Workshop to safely remove electrical and electronic components from equipment, for reuse
- Workshop to fasten materials together using the source materials, without glue or using specially made food-based glue
- Poster making technique session

Assessment rubrics, subject to examination board scrutiny, were developed for every aspect of the module, in alignment with the Quality and Qualifications (QQI) Ireland framework.

Whilst it is not possible at this time to reveal how well the students matched against the assessment, it can be said that those students who used engineering principles to produce artefacts which functionally improved sustainability, whilst using fully recyclable materials and components, with a clear end of life migration path, were most successful. It was clear that the most successful students communicated and acted in ways which took full responsibility for sustainability with their project and fulfilled the brief they had set. Indeed, the author of this paper learn much technically from the students as well as their embedded ecological motivations for all actions taken. It was also possible to see the gulf of understanding between functionality and sustainability that existed for some students.

With the students' permission, here is a selection of photographs of the artefacts at the final presentations, in Figures 1. and 2. below.

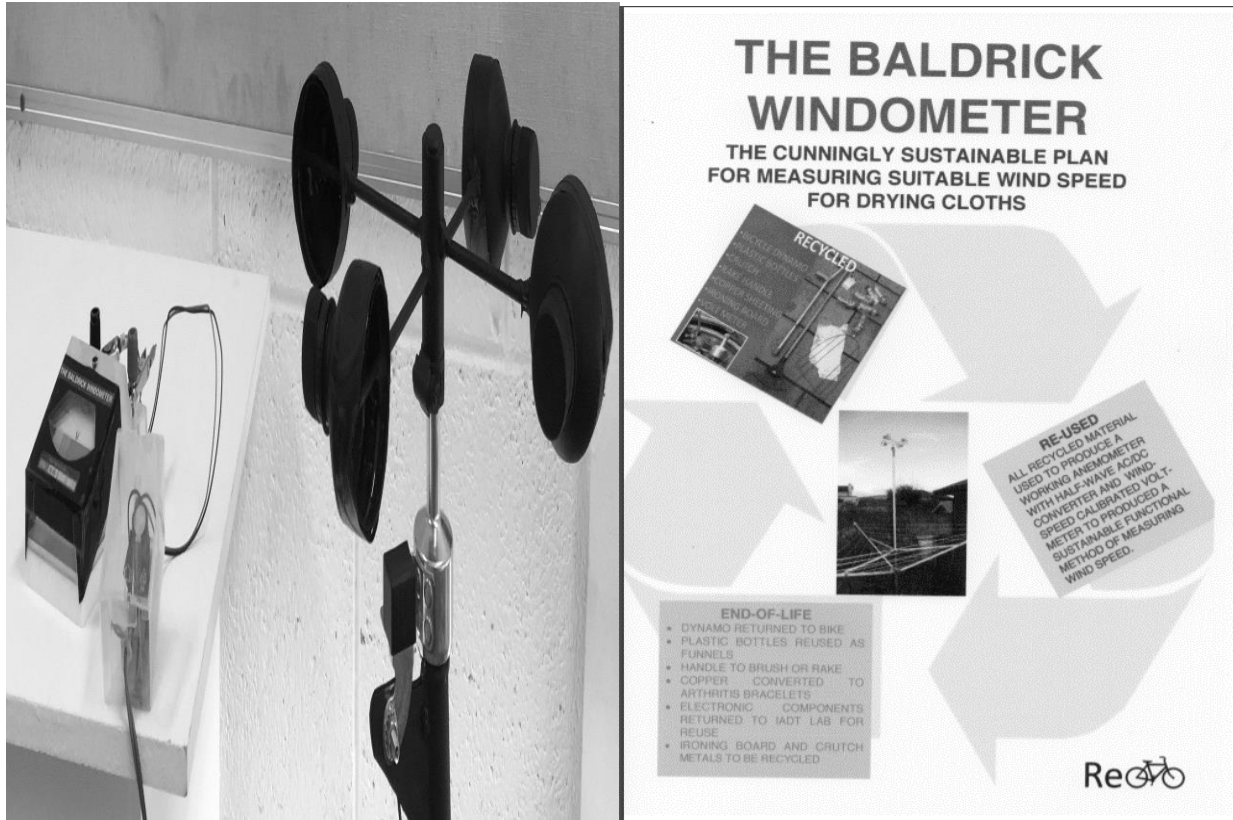

Figure 1. Anemometer with dynamo which activates a Met Eireann compatible Windspeed Indicator



Figure 2. Bubble making machine using eco-friendly washing up liquid and dual motor system

4 Proposed Principles of Sustainable Electronic Engineering in Higher Education

The survey of initiatives in embedding sustainability in higher education programmes, particularly those associated with electronics, leads to the following suggested criteria for developing taught modules in this area:

- Build sustainability into the whole life cycle of design-use-reuse All stages in the project and produce life and resurrection as another product need be audited for sustainability.
- Question at every stage of design, the sustainability of the choice made. This is a similar approach to the Life Cycle Assessment (Sharma *et al*, 2017).

- Ensure the product function and aesthetic motif encourages people towards a sustainable lifestyle.
- Approach the project such that aesthetics is a secondary aspect to sustainability
- Plan and implement the whole project development process, adopting sustainable processes at all stages of development, tools and environments used, as discussed by Braun (2010)
- Plan and implement throughout, in a practical way to use the least electrical power and assess the renewability of the sources, choosing one with the highest level
- Implement measures for ecologically safe disposal of any materials that could harm the environment, ultimately avoiding such byproducts in the first place

- Use of recycled electronic parts from other equipment or parts that have been manufactured from recyclable sources. Never overlook any discarded item without evaluating its potential for something else.
- Keep a record of all items being stored before ordering something new – the case for ordering new has to be justified in terms of usage in engineering educational products versus the effects on the environment if ordered as new.
- Consider using naturally degrading materials such as wood, metal, as opposed to plastic. If using plastic, ‘single use’ should be adopted.
- Use fastenings, made for instance from the parent material and non-toxic glue where possible

- Present projects in a way which uses the least electrical power and material wastage
- Follow the life-cycle plan in disposing of the final working product at its functional end of life, following a path component re-use.

5 Conclusions

The research into different sustainable engineering higher education programmes worldwide indicated that there is much more to do, in the development of approaches to teaching sustainable electronics engineering, and fostering this approach through projects and research in the campus environment. Whilst programmes may by piece-meal associate their programmes with sustainability modules, the most successful outcomes occur when there is a campus-wide permeation of these principles. Therefore a cross-disciplinary approach within the engineering discipline and outwards to arts and business sectors, would help to unify the overall goal of education students in sustainability.

The ESD module at IADT has shown the benefits of a very practical, creative and project driven approach to sustainable electronic engineering education can be implemented for non-engineering students in a successful manner, thus immediately creating a cross-disciplinary approach.

The principles of fostering a sustainable approach to electronic engineering in higher education can be summarised as a need for students to question the development approach at every stage, be fully conscious of their choices in materials and components up to the presentation stage, and secure an ecological end of life/re-use path.

6 References

Braun, B. 2010. Teaching Sustainability Analysis in Electrical Engineering Lab Courses. *IEEE Transactions on Education* **Vol. 53**, NO. 2

Christensen P., Mikkel Thrane M., Herreborg-Jørgensen T. & Lehmann M. 2009. Sustainable development Assessing the gap between preaching and practice at Aalborg University. *International Journal of Sustainability in Higher Education* **Vol. 10**, No. 1, 4-20.

The Department for Education and Skills 2014. *Education for Sustainability: The National Strategy on Education for Sustainable Development in Ireland, 2014-2020*.

Lobos, A. & Babbitt C.W. 2013. Integrating Emotional Attachment and Sustainability in Electronic Product Design. *Challenges* **2013**, 4(1), 19-33.

Magdalena S., Lozano-Garcia, F.J. & Rowe, D. 2008. Learning Outcomes for Sustainable Development in Higher Education. *International Journal of Sustainability in Higher Education* **Vol. 9**, No. 3, 339-35.

Mukhtar, N & Saud, M.S.B. 2019. The Need for Incorporating Sustainability Thinking into Higher National Diploma Electrical/Electronic Engineering Curriculum in Nigeria. *Asian Social Science*, **Volume 15**, Issue 8.

Satti, S. 2018. An Electrical Engineering Design Project with a Sustainability Theme. *In: EESD 2018 Proceedings*, Rowan University, USA, 81-82 (Abstract only)

Sharma, B., Steward B., Ong, S.K. & Miguez, F.E. 2017. Evaluation of teaching approach and student learning in a multidisciplinary sustainable engineering course. *Journal of Cleaner Production*, **Volume 142**, 4, 4032-4040.

Challenging energy engineering undergraduates with diverse perspectives on nuclear power (EESD2020)

Fionn Rogan^{1,2}, Hannah E. Daly^{1,2}, Paul Deane^{1,2}, James Glynn^{1,2}, Paul Leahy^{1,2}, Edmond Byrne^{1,2}

¹School of Engineering, University College Cork, Republic of Ireland

²SFI MaREI Centre for Energy, Climate and Marine, Environmental Research Institute, University College Cork, Lee Road, Cork, Republic of Ireland

f.rogan@ucc.ie

Abstract

As part of an introductory energy engineering undergraduate module at University College Cork, student presentations on a zero-carbon energy plan for Ireland have shown a high preference for nuclear energy, despite a complete absence of nuclear energy from the same module curriculum. Nuclear power has never been built or generated in Ireland, is currently illegal, and faces high levels of public opposition. The origins of a high preference for nuclear energy among undergraduate student engineers is therefore unclear. In response to this high preference for, but critically unengaged view of nuclear power, the authors developed a participatory learning activity for first year undergraduate engineering students to engage with a range of maximally different perspectives on nuclear power. Four different perspectives on whether Ireland needs nuclear power were presented to this year's class: *definitely yes*; *definitely no*; *maybe yes*; *maybe no*. These perspectives involved a number of different framings of nuclear power and ranged across a spectrum from techno-economic to socio-technical. They emphasised to a greater or lesser degree issues around risk, cost, system impacts, timing, social acceptability, and sustainability. The activity took place in a room divided into four quadrants with each quadrant representing one of the four different perspectives on nuclear power. At the start of activity, students were invited to go to the quadrant that best represented their initial views. Each perspective on nuclear power was then delivered in a short expert presentation by one of the co-authors. Throughout these presentations, students were invited to remain in or move from their quadrant as they were persuaded or not by the arguments advanced. At the start of the activity, an overwhelming majority (96%) of the students indicated a *yes* preference with the majority of these being *maybe yes* (79%); at the end of the debate the total *yes* share had significantly decreased (to 54%), with the largest share of the lost vote moving to the *maybe no* category which finished at 36% (having started at 0%). Overall, there was a greater distribution of students across all four categories than at the start. Evaluations on the activity format were largely positive. Student reasons for changing their views were mostly socio-technical points specific to Ireland that included the electricity system, overall energy needs, costs and expert availability. Closing reflections introduced the idea of a wicked problem and highlighted the importance of values to questions such as "Should Ireland Go Nuclear", i.e. avoiding an exclusively narrow scientific framing.

1 Introduction

1.1 Background

In University College Cork (UCC), there are four undergraduate engineering degree courses: civil, structural and environmental engineering; electrical and electronic engineering; process and chemical engineering; and energy engineering. The first year of all these degree courses is a common year with identical subjects and modules being taken by all students; it is only at the end of their first year that students nominate their preferred stream of engineering, which they subsequently embark on in second year. The modules the students take in their first year are a range of foundational engineering subjects (physics, chemistry, thermodynamics, mathematics, etc.) and an introductory course to each stream of engineering.

As part of the introductory undergraduate module to energy engineering, students are introduced to a range of energy engineering related topics (fossil fuels, renewable energy, energy efficiency, electricity systems, climate change, etc.) and undertake a group project as part of their course work. For a number of years, the main group project was to develop an “Energy Plan for Ireland” using a similar format to the “Five energy plans for Britain”¹ devised by David McKay in his book *Sustainable Energy - without the hot air* (McKay, 2009). The “Energy Plan for Ireland” exercise required students to outline a low carbon energy plan for Ireland that balanced the supply of low carbon energy with the demand for energy (in the form of heat, electricity and transport).

While teaching and evaluating this module in 2018, two authors of this paper noted the very high preference for nuclear energy, despite a complete absence of nuclear energy from the same module curriculum. Nuclear power has never been built or generated in Ireland, is currently illegal, and faces high levels of public opposition (Red C Research & Marketing, 2011). The origins of a high preference for nuclear energy among undergraduate student engineers is therefore unclear. Although nuclear energy engineering is taught on the energy engineering curriculum, it is not until second year. For the authors it seemed important to engage with the students’ preference for nuclear energy but also to engage with the fact that it’s an energy source with a lack of popular support, despite not being built in Ireland.

1.2 Engineering Ethics

While a significant part of the engineering curriculum in UCC is technology and scientific focused problem-solving, as part of the accreditation provided by the professional body of engineers (Engineers Ireland), there is a requirement for tuition that introduces the ideas and practices of engineering ethics. Additional tuition includes the topics of complexity, uncertainty and wicked problems. Accommodating these topics within the existing engineering curriculum in UCC has involved a number of different approaches (Byrne and Mullally, 2014), some relatively standalone, others more integrative.

1.3 Interactive Learning

In response to the high preference for, but critically unengaged view of nuclear power, the authors developed and organised a participatory learning exercise for undergraduate engineering students to engage with a range of maximally different perspectives on nuclear power. The activity was designed to teach

¹ https://www.withouthotair.com/c27/page_203.shtml (accessed Feb 13th 2020)

students about nuclear power, its complexity, the context in which it must operate (and by extension, the importance of context), and to do so in an engaging, open and stimulating format.

2 Methodology

2.1 Four-way debate

The authors devised a four-way debate built around the question, “Should Ireland Go Nuclear?”; four maximally different answers or perspectives were prepared: *definitely yes*; *definitely no*; *maybe yes*; *maybe no*. Each of these perspectives involved a number of different framings of nuclear power and ranged across a spectrum from techno-economic to socio-technical. The arguments emphasised to a greater or lesser degree issues around energy density, risk, cost, system impacts, institutional capacity, social acceptability, and sustainability. The main points are summarised in Table 1.

Table 1: Arguments

Page	<i>Definitely Yes</i>	<i>Definitely No</i>	<i>Maybe Yes</i>	<i>Maybe No</i>
Energy Supply	10000 years of uranium supplies exist			
Energy Density	Nuclear superior to all fuels			
Electricity System	Nuclear can balance intermittent renewables	Significant amounts of nuclear waste generated	Nuclear SMRs could be a good fit for Ireland’s small system	
Consequences of an accident		Examples of Chernobyl & Fukushima		
Energy Security		Uranium an import dependency	Backup required for all power stations, not just nuclear	
Social Acceptability		Processes are challenging for Ireland		Protracted process highly likely
Cost		Cost escalation more likely		Nuclear costs are rising; RE costs are falling
Institutional Capacity		Poor capacity to deliver; training & expertise absent	SMRs built abroad so training needs not an issue	Ability to deliver large infrastructure projects weak
Public Trust				Low levels of trust in gov make nuclear challenging

The room in which the activity took place was a mostly open empty space (a bespoke university innovation space, located within the library) with four corners each representing one of the four different perspectives. A number of chairs were positioned in each corner. The sequence of stages of the activity was as follows:

1. Students arrived; were introduced to the event; before any presentations took place, the students were invited to go to the corner that best represented their views on “Should Ireland Go Nuclear?”
2. An expert speaker gave a 5-minute speech arguing the *definitely yes* perspective; afterwards students were invited to move to a different corner if they had changed their minds
3. An expert speaker gave a 5-minute speech arguing the *definitely no* perspective; afterwards students were invited to move to a different corner if they had changed their minds
4. An expert speaker gave a 5-minute speech arguing the *maybe yes* perspective; afterwards students were invited to move to a different corner if they had changed their minds
5. An expert speaker gave a 5-minute speech arguing the *maybe no* perspective; afterwards students were invited to move to a different corner if they had changed their minds

At all but one of the stages, there was traffic of students moving from one corner to another. It was clear to all participants that the distribution of preferences was different at the end than at the start. After the last stage, there was a show-of-hands for how many students had changed their views once, twice, or more than twice. Then, students were encouraged to ask any questions, raise any comments, and to offer their reflections on the results as they could see them (i.e. the changed distribution of preferences across the four categories). Then, each of the four expert speakers was invited to give their ‘real’ view, whether influenced or not by the presentations of the other expert speakers. Finally, there were some reflections from one of the co-authors on complexity, uncertainty and engineering ethics. At the end of the activity, students were asked to fill out a short activity evaluation form.

3 Results

3.1 Four-way debate - changing views

28 students participated in the activity. At the start, when the students were asked their pre-presentation perspectives, an overwhelming majority (96%) were in either of the *yes* categories (*definitely yes*, 18% or *maybe yes*, 79%); see Table 2 for all results. At each subsequent stage (2-5), the shared total of *yes* declined until it reached a combined share of 54% at the end. While it could be said that *maybe yes* “won” the debate (i.e. it ended with the largest share) this was largely because it started with the largest share. *Maybe yes* never increased its share throughout and in all but one stage it decreased in size; of all the categories, it lost the most votes. Overall, there was a greater distribution of perspectives across all categories at the end of the debate than at the start: at the start, two categories were <5%; at the end, all categories were >10%. The relative share of *definitely* and *maybe* changed less throughout the debate. At the first stage it had a 79% combined share, throughout the stages it declined to 68% and 61%, then at the last stage it returned to 79%.

Table 2: Share of participants in each category at each stage

Page	Share of Participants			
	<i>Definitely Yes</i>	<i>Definitely No</i>	<i>Maybe Yes</i>	<i>Maybe No</i>
Stage 1	18%	4%	79%	0%
Stage 2	29%	4%	68%	0%
Stage 3	29%	11%	54%	7%
Stage 4	29%	11%	54%	7%
Stage 5	11%	11%	43%	36%

3.2 Reasons for changing their views

A majority of the participants (54%) changed their views throughout the debate; most of these changed their minds once (43%); the remaining changed their minds twice (11%). The numbers of who changed their views are shown in

Table 3.

Table 3: Number of participants who changed their views

Count	Number of Participants			
	Didn't Change	Changed Once	Changed Twice	Change > Twice
	13	12	3	0

The student evaluations revealed some of the reasons the students changed their views. A majority who changed their views indicated it was because they concluded Ireland didn't need nuclear energy:

- *"I changed my views as Ireland does not need huge energy supply as the country is small [...]"*
- *"It was due to the fact that we may not need nuclear energy"*
- *"Because nuclear might not be needed, better to import it"*
- *"While nuclear might be needed worldwide, might not suit Ireland"*
- *"Yes nuclear is needed on a global scale but is it really needed for Ireland? The money could be used to improve more renewable energy"*

Others indicated that nuclear energy mightn't be a good fit for the existing electricity system in Ireland:

- *"Doesn't seem to suit Ireland as a country"*
- *"Load levels and the fact it doesn't fit in our grid"*

Other factors cited for changing their minds included cost, lack of expertise, risk, and affordability:

- *“There were many facts which were brought up that I had never considered before such as costs and facilities and training”*
- *“Risk of nuclear is still not 0%. Ireland does not [...] have the resources to maintain a nuclear plant”*

Although 46% of the participants didn't change their views, only two out of these thirteen indicated why:

- *“Nuclear energy could happen, but it's being delayed by the severity of risks and costs. But at the same time, every other renewable resource has come with risks. At the day in age, we need all the energy we can get”*
- *“Political will never be there for nuclear in Ireland”*

3.3 Event format feedback

Students were also asked their perspectives on the format of the event. Most were positive while one had a suggestion for more participation during the voting stages (rather than just at the end)

- *“Very good. Involved. Made you think”*
- *“Very well presented arguments, made me unsure on where I stood on nuclear energy”*
- *“Done well”*
- *“Questions should have been allowed to be asked after each point”*

4 Discussion

4.1 Student engagement

From the student evaluations and talking to the participants, the overall response to the format of the debate was positive. The event was designed to encourage and facilitate participants to consider different viewpoints and to make it easy to change their minds. At a deeper level, the aim was to encourage students, through active engagement and participation to think critically (in this case in the context of considering nuclear power). This was to be achieved by demonstrating the complexity that permeate socio-technical projects and domains, and hence the requirement for engineers to be wary of seeking hard and fast reductive or technologically (alone) based ‘right answers’. The fact that a majority did in fact change their minds (54%), and for them the significant information seemed to be energy system context (Ireland's need for growing amounts of energy), electricity system properties (minimum size of plant, security of electricity supply), socio-technical factors (expertise and training), and political factors (trust in government). The importance of being open to changing one's mind was emphasized near the end of the event when each of the expert speakers was asked their ‘real’ view: only one out of the four speakers ‘agreed with themselves’, with three of the other four citing arguments or points made by other speakers or students as being persuasive.

While some students clearly learned new information that changed their minds, for the students that didn't change their minds it is unclear if the information they received was new or not new and whether it was sufficient or insufficient to confirm or strengthen their pre-existing views. Interestingly, the most positive

event evaluation comment (“*Very good. More please*”) was from the student who started and remained in the *definitely no* category throughout. On the other hand, two participant evaluations from those who started and remained *definitely yes* throughout, both critiqued aspects of the debate format, “*Questions should have been allowed to be asked after each point*” and debate content “*Nuclear waste has solutions*”, the latter contradicting a point made during an expert-presentation and raised during the student questions at the end.

4.2 Interactive learning

Participant feedback on the format of event was largely positive, e.g. “*Very good. Involved. Made you think*”. The event duration was one hour and due to the participants regularly moving around, there were no sustained periods of sitting, which seemed to contribute to the high levels of attention throughout. In addition, because the participants had to respond to the short expert presentations with a decision (i.e. move corners or not), this also seemed to encourage high attention levels. Finally, due to the layout of the room with the expert-speakers standing in the middle while encircled by the four categories, there was no traditional “front” of the room where a lecturer would stand and “back” of the room where students would congregate something which in the personal experience of the authors had led to diminished classroom engagement.

4.3 Engineering complexity and ethics

While the students came to the event expecting a series of arguments for and against nuclear, and this is largely what they got, the cumulative effective of the different arguments and perspectives advanced was that the nuclear energy issue was presented and perceived as complex. It has many dimensions. In some closing reflections by one of the authors, this point was highlighted and extended to introduce the concept of the wicked problem. If engineers sometimes look for easy solutions or ‘right’ or simple answers, the many facets of nuclear energy show this isn’t always appropriate. While this may seem a self-evident point, our experience of undergraduate engineers, in particular with first years demonstrates that they find this a challenge. From a teaching perspective it was easy to make the observation about multiple dimensions to a problem due to the format of the event which was structured around different perspectives on a single question. This particular format also facilitated an opportunity for students to better develop a necessary appreciation of socio-technical complexity by actively engaging with the topic at hand.

During the closing reflection, a further point raised was observations about the role of science and values. It was pointed out to the students that questions such “Should Ireland Go Nuclear?” can’t always be answered with recourse to “mere science” alone, i.e. values are an important part of the debate too. From an engineering ethics perspective, it is also vital that students and engineering professionals understand this point, as failure to do so has (too) often resulted in well-designed projects from a technical perspective facing unexpected public opposition. This results in engineers often resorting to speculation that this can be resolved by better (scientifically and technologically) educated publics, when in fact opposition often comes from highly educated persons who are objecting on the basis of values-based grounds. This is because such projects go beyond the merely technological domain and into economic, ecological, social, legal and ethical domains. Such a post normal scientific environment can thus facilitate inherently normative projects (and concepts such as the precautionary principle, among others), whereby science alone cannot provide definitive direction. Recognition of this results in engineers who are more comfortable in

embracing complexity and successfully engaging with multi-level socio-technical systems, such as associated with the provision of nuclear power. The authors believed the students were more receptive to this point after themselves finding it difficult to find an easy answer to the question posed, “*Very well presented arguments, made me unsure on where I stood on nuclear energy*”.

5 Conclusions & Recommendations

5.1 Conclusions

The question “Should Ireland Go Nuclear?” is a complex one with many dimensions and viewpoints. Experts do not necessarily agree, and more information does not necessarily bring more certainty. This was borne out by the contents and outcomes of the four arguments that were advanced. The four-way debate, with participant voting and speaker reflections, was an effective way of introducing the wicked problem concept and of demonstrating how nuclear power is an exemplar of this. The four-way debate was an engaging exercise for the students, who via the activity evaluations forms gave a largely positive verdict.

5.2 Recommendations - Future Activities

The event format could be readily adapted to any issue, in particular complex socio-technical issues where there exist strong viewpoints for and against. Parts of the event format could also be adapted to include questions between rounds (as per a student suggestion). The event format could also be redesigned into a student assignment in which students themselves develop the presentations and deliver the arguments; these students could come from the same class or could come from a subsequent year (i.e. second, third or fourth year) of energy engineering. Near the end of the round of arguments, the event chair highlight that each of the expert speakers had emphasised different points rather than directly contradicting each other; i.e. their arguments had consisted of what they said but also what they didn’t say. The exercise could be a springboard for a critical thinking skills class, i.e. how do I evaluate contradictory expert arguments?

Acknowledgements

Thanks to the 28 students who participated in the event. Thanks to the volunteers who counted the student preferences at each round (Jason McGuire, Aoife Hughes, Vahid Aryanpur, Connor McGookin). Thanks to Mark Sugrue for many arguments on Twitter that contributed to the contents of definitely yes argument.

References

Byrne, E.P., Mullally, G. 2014. Educating engineers to embrace complexity and context. *Proceedings of the Institution of Civil Engineers - Engineering Sustainability*, **167**, 6, 241-248.

McKay D.J.C. 2009. *Sustainable Energy – without the hot air* First edn. UIT Cambridge, England.

Red C. 2011. *Impact of Japan Earthquake on Views About Nuclear Energy*. <https://www.redcresearch.ie/wp-content/uploads/2015/10/RED-C-Research-Press-Release-Japan-Earthquake-Survey-Snap-Poll.pdf> (accessed Feb 14th 2020)

Excellence in education requires excellence in collaboration: learning modules in circular economy as platforms for transdisciplinary learning

A paper to be presented at 10th Conference
on Engineering Education for Sustainable Development (EESD2020)

N. Sandström¹, A. Nevgi¹ and Thomas Betten²

¹Campus Learning and Development Initiatives Hub Caledonia, University of Helsinki, Republic of Finland

niclas.sandstrom@helsinki.fi

²Fraunhofer Institute for Building Physics (IBP), Stuttgart, Federal Republic of Germany

others in alphabetical order

A.R. Balkenende (Delft University), P. Danese (University of Padova), R. Graf (Fraunhofer, Germany), K. Grönman (LUT). Holopainen (MR Hub, University of Helsinki), S.I. Olsen (Technical University of Denmark)

Abstract

Circular economy (CE) is drawing attention in the fields of sustainable science and engineering. The aim of the paper is to describe how a consortium of 6 European universities or research institutes (Lappeenranta-Lahti University of Technology, Finland; Delft University of Technology, the Netherlands; Fraunhofer, Germany; Technical University of Denmark; Università degli Studi di Padova, Italy; University of Helsinki, Finland) that build new co-created learning modules in CE based on modern collaborative pedagogical approaches that include flipped learning (Bergman & Sams, 2012). In the modules a feed-forward toolkit for student engagement and participation was applied. The paper also discusses student and teacher experiences and perceived benefits of using the pedagogical engagement approach.

1 Introduction

Circular economy (henceforth, CE) is drawing growing attention in the fields of sustainability science and engineering. CE refers to an approach to economic growth that is in line with sustainable environmental and economic development, and currently promoted by the EU and other governments and businesses globally (Korhonen, Honkasalo & Seppälä, 2018). The basic idea of CE is based on material cycles and reuse of materials. Circular economy provides an alternative, cyclical flow model in an economic system with a promise to reduce negative environmental impacts and further stimulate new businesses (Korhonen, Honkasalo & Seppälä, 2018). In their systematic literature review, Prieto-Sandoval, Jaca and Ormazabal (2018) present, based on a close analysis of 162 related article, the following definition of CE (p. 610): “*The circular economy is an economic system that represents a change of paradigm in the way that human society is interrelated with nature and aims to prevent the depletion of resources, close energy and materials loops, and facilitate sustainable development through its implementation at*

the micro (enterprises and consumers), meso (economic agents integrated in symbiosis) and macro (city, regions and governments) levels. Attaining this circular model requires cyclical and regenerative environmental innovations in the way society legislates, produces and consumes.”

Sustainable development was originally defined briefly by the Brundtland Commission as Humanity's "ability to make development sustainable to ensure that it meets the needs of the present without compromising the ability of future generations to meet their own needs" (WCED, 1987). Later, sustainable learning and education have been defined as referring to the process where learning communities are seen as active agents in promoting sustainable practices (Sandström, Nevgi & Nenonen, 2019).

In engineering sciences and economics, the topics related to CE and sustainable development concern both complex and practical issues that need to be taught and learned. There is a need to address the challenges of CE and sustainable development, being complex and systemic concepts, both from a theoretical and a practical, hands-on point of view, through participation in expert communities (Hakkarainen et al., 2004) for instance in the form of industrial partnerships (Stephenson, Stephenson & Mayes, 2012). For historical reasons, education tends to establish niche competences - and neglects the holistic perspective. For example, the traditional mindset of mechanical engineering education often lacks the far-reaching consequences that material and production process selections as well as product design as a whole have on the entire life cycle of a product. The lecture model of teaching does not support students in learning complex issues or reflecting upon the practice and activity. Furthermore, in the working life, students will meet these challenges, and transdisciplinary learning is called for in order to prepare students to achieve capacities and competencies relevant for working life. These include for instance working in hybrid teams and collaborating with people from a different cultural background.

A consortium of 6 European universities or research institutes (Lappeenranta-Lahti University of Technology, Finland; Delft University of Technology, the Netherlands; Fraunhofer, Germany; Technical University of Denmark; Università degli Studi di Padova, Italy; University of Helsinki, Finland) was established 2019 for a three-year ongoing research and development project (EIT Raw Materials, e-CirP), and a common goal of the consortium is to build new co-created learning modules in CE. The modules share a pedagogical and thematic framing as well as learning at the university-industry nexus through cases provided by companies.

The consortium develops educational modules based on modern collaborative pedagogical approaches that include flipped learning (Bergman & Sams, 2012), cooperative learning (Foldnes, 2016) and service learning (Stephenson, Stephenson & Mayes, 2012). The aligned educational modules are provided on a common platform where the students can access the learning materials produced as part of the project. These include introductory and explanatory videos, scientific papers and encouragement for reflections before meetings with instructor and doing hands-on learning in the industrial cases.

1.1 Aims

In the paper we describe the project and the consortium, how the work packages were framed and what was considered important by the collaborating universities. In the core there is circular economy and sustainable development and the need for the creation of educational modules of CE among European universities. The paper discusses a toolkit for producing student engagement through participation in the framing of the course and its practices.

Circular economy and circular product design are rising in the EU and national agenda, but in practice, there is still a gap in implementation. Especially small and medium sized enterprises lack the resources and expertise to adapt life cycle responsible design in their business. Larger companies may have implemented already the reductionist approach through eco-efficiency, but disregarding the holistic sustainability, detrimental rebound effects may occur (Bocken et al 2014; Dyllick and Hockerts 2002; Kasurinen 2017; Korhonen and Seager 2008).

Material selection is often executed in hands-on manner without an integrated optimization process with relevant product and production engineering aspects (Kaspar et al. 2016). On the other hand, an environmental engineer can assess the overall result of the product's environmental performance. However, s/he would benefit from understanding the properties of materials as well as requirements of manufacturing processes in order to have an actual say on the product design phase. Moreover, for a successful change into sustainable business model in the product design phase these two approaches are not enough. Support is also needed from the business and industrial engineering educators.

Circular and sustainable product design requires new business models and concepts as well as value creation both in the context of creating better value for customers and shareholders. In addition, emerging concepts such as frugal innovation, “an ability to do more with less by creating more business and social value while minimising the use of resources such as energy, capital and time” (Radjou and Prabhu, 2014), need to be conveyed not only for use of academia but industry too. ‘A holistic rethinking of products, services, underlying processes and business models so that companies can squeeze costs and expand the customer base, business and profit’ (Jagati, 2011) is needed within Europe. Not only in Eastern Europe but also in developed economies, and this demand is likely to increase in future, as a result of socioeconomic and demographic change and increasing resource constraints. Moreover, lacklustre growth, aging population, environmental constraints and growing demand for sustainability are some of the reasons that create pressure for more frugal models of production and consumption in the developed world (Bound and Thornton, 2012). In addition, entrepreneurship is to be covered in a sense that the students would gain insights of the requirements of product design in a new business, and thus be more prepared as possible future entrepreneurs.

Besides the importance of developing the content of the courses delivered by this project, it is just as important to become aware of emerging technological solutions that can improve learning and lifelong learning markedly. Flipped classroom (Bergman and Sams, 2008; Kim et al., 2014) offers new ways to implement authentic and current topics for learning and teaching purposes, and gives the learner the possibility to study more flexibly before lectures. Combined with Virtual Reality (VR) solutions, for instance, the approach can help in educating employees, teachers and students alike, and in more engaging ways. Real-world objects and applications can be approached using e.g. VR in ways that bring them closer to each other despite geographical distance. Also, VR is more accessible than ever when the price sweet point will most probably be reached in the near future, making it easy to attain and maintain. Nonetheless, VR in itself is not the only way forward, but instead, better content is needed, including real-life enterprise cases and student-centred pedagogical approaches.

Accordingly, this project aims to combine these three viewpoints, 1) mechanical engineering and product design, 2) environmental engineering and sustainability assessment, and 3) business aspects in education modules - complemented with genuine industrial cases. The industrial cases will address the right level of complexity in education and enforce the system

perspective and life cycle thinking. In addition, the companies will have an advantage when students address their cases from multiple perspectives. These viewpoints are passed on to students using novel teaching methods and techniques. The pedagogical innovations will be developed and trialled in parallel to combine the viewpoints of students and teachers who co-create learning experiences together when working on the industrial cases with help of e.g. Virtual Reality environments. The education modules will act as testing platforms for new ways of learning for both the students and the teachers.

2 Consortium and work packages

The consortium has seven partners from different parts of Europe representing the three knowledge triangles. The LUT University, TU Delft, DTU, University of Padova and University of Helsinki represent the academia, and their Master students are being targeted in this education development. Fraunhofer as a research institute offers an application-oriented approach to education, and in addition, enhances a course at University of Stuttgart. Outotec, a process technology and service provider in the field of metals and mining, complements the group by providing industrial insight and quality assurance, to ensure the students are gaining abilities required in today's working life. The project is financed by EIT Raw Materials, a Knowledge and Innovation Community under EIT, focusing on the raw material sector worldwide.

The length of the project is three years (2019-2021). In the first year, the learning outcomes of the five education modules were set, and education materials and teaching and learning practices were designed and created accordingly. Five courses were piloted in different campuses around Europe starting in the autumn semester 2019.

In 2020 and 2021, more education material is created, and student co-operation across different universities is initiated. The students will work on a real-life challenge (the learning object) from a case company, to optimize or improve the circular economy of a product or a service. On one hand this will teach the students to cooperate in a multidisciplinary team and recognize the value of different points of view contributing to a solution, while on the other hand the companies will benefit from the insights that are generated from this broad overall perspective. In these two final years of the project, we will also explore the possibilities that virtual reality (VR) can offer in supporting education and collaboration on shared learning objects between the countries, especially in the field of circular economy.

The project is divided into eight work packages (WP). Each WP is led by a partner with special expertise on that topic. The topics were formulated in order to cover the key points in optimizing the technical cycles in the framework of circular economy. LUT as the project coordinator is responsible of project management (WP1). Another overarching WP, the second one lead by University of Helsinki, ensures that high quality and novel teaching methods are implemented throughout the following six education modules. The education modules are presented in Table 1.

Table 1. Education modules of the project

Education module name	Lead partner	Main content
WP3: Circular Economy	University of Padova	Analyzing several concepts related to circular economy with a focus on companies' sustainability capabilities and strategies, and supplier management

WP4: Product design & Material selection & Production methods	LUT University	Optimizing sustainable production process focusing on material selection, product design and related production methods
WP5: New Business models & Innovation approach	LUT University	Integrating circular economy into the management of strategy, innovations and business models
WP6: Value chain optimization	Fraunhofer	Optimizing value chains in a global and local scale while aiming to close the material loops.
WP7: Assessment	DTU	Introducing quantitative sustainability assessment methods for supporting decision-making and development of sustainable technology with regard to circular product design and optimization
WP8: Case development	TU Delft	Co-creating and solving case studies with industry based on their actual challenges, such as selecting raw materials, production technologies, optimizing life time of a product, optimizing environmental impacts and increasing circularity.

3 Student engagement: active learning and participation

Following the lines of Kolb (1984), we take it that experiential learning, as in the educational modules here developed, is a process rather than an outcome. It takes place when instructors allow the students to participate through their unique concerns and thus promote learning and adaptation. The leading, radical principle in developing the educational modules is the change from describing learning objectives to student engagement.

Student engagement has been extensively studied since the seminal work of Alexander Astin's student involvement (1984). In his theory of student involvement, Astin emphasized students' active participation in the learning process, and stated that educators need to focus more on what a student does than what are the content, books, materials, teaching techniques and other resources of teaching. The construct of student involvement implies not only the psychological state of a student, but also the behavioral manifestation of the state, possible to be observed and studied (Astin, 1984). A sound body of research has identified a robust correlation between student engagement and positive student achievement such as persistence, academic achievement, and learning outcomes (e.g. Tinto, 1975; 1993; 2007; Pascarella and Terenzini, 2005).

During the past 20-30 years, researchers and professionals have produced a significant body of research pointing to the fact that student engagement is strongly supported by active learning (e.g. Aksit, Niemi & Nevgi, 2016; Nevgi, Virtanen & Niemi, 2006). Since 2012, the flipped format in courses of engineering education became popular (Karabulut-Ilgü, Cherrez & Jähren, 2018).

In teaching engineering sciences, educators are unanimous that engaging students to study complex problems and projects results in better understanding and learning (Lombardi & Oblinger, 2007). However, they prefer lecturing, seeing it as the best way to deliver theoretical and background information necessary for students to solve engineering problems (Bishop & Verleger, 2013a; 2013b). However, converting traditional lectures in flipped format requires quite a huge amount of investments and efforts from educators and instructors.

4 Toolkit to support student engagement and interactive participation

In the modules a feed-forward toolkit for student engagement and participation was applied. This was done to overcome the problems and biases that are found in most retrospective traditional feedback and student evaluations of teaching effectiveness - a challenge identified for decades (Kemp & Kumar, 1990; Emery, Kramer & Tian, 2003; Boring, Ottoboni & Stark, 2016). The toolkit's tenet is the timely and immediately beneficial participant engagement that affects the course content, the approaches used and potentially also the assessment criteria. The tool is a browser-based solution and it is based on close-to-zero effort participation through submission of ideas, concerns and questions, followed by pairwise comparisons of the submissions. The immediate outcome is a ranking list of participant submissions, made by the participants themselves, and it can be used immediately after the pairwise comparisons to discuss student ideas and concerns and co-design the learning module.

Through a systematic, anonymous collection and implementation of participant concerns and ideas, the learning module can be authentically co-created. We use participant experiences and concerns as the key in developing relevance in terms of skills for work life.

Data and analyses

The data consist of documents of different CE modules and students' responses using a feed forward toolkit and teacher reflection on the benefits of using the tool. Participant feedback was collected by individual and group interviews and by a feed forward toolkit. The toolkit - a browser-based solution - is based on close-to-zero effort participation followed by pairwise comparisons of the submitted participant ideas, concerns, questions etc. The pairwise comparison results in a "voting" or ranking result that can be used for a joint discussion in class. Ideally, the collection is done in 3 cycles: 0-10 % of the course, then at 49 % and eventually, at the end to collect a set of ideas, improvements and feed forward for next students taking the course. The collection is GDPR compliant (anonymous; no record of users is collected or archived). The engagement results were analysed using qualitative content analysis and semantic classification. First, a four-fold table was used to classify the participant submissions along dimensions theory (of CE, sustainability \longleftrightarrow practices/skills on the x-axis and curriculum \updownarrow working life on the y-axis.

An abductive turn in the collaborative researcher effort resulted in the following analysis diamond, whose dimensions represent the ones found in the student expressions and that work on the facets of the diamond (moving e.g. from expectations related to curriculum/assessment and being coupled with reflections regarding future CE competencies needed in working life (Fig. 1).

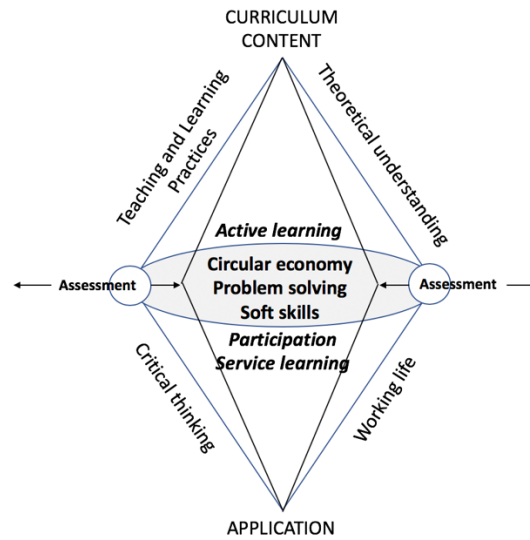

Figure 1. Analysis diamond with facets representing dimensions found in the data.

5 Findings

Expected outcomes include the stepping stones on how to build in co-operation education modules that serve the needs of various universities teaching circular economy for students with different disciplines and backgrounds. During one of the courses, several student concerns that ranked high after the submission–ranking regarded the pilot nature of the course and the curricular setting, the workload and its relation to the ECTS granted for taking the course. These were content-related worries. Another dimension found ranking high was the relationship of learning theory and the ability to later apply the things in working life and when applying CE strategies in organisations.

Also, the students seemed to have pre-knowledge about methods used in CE and assessment of CE (e.g. LCA) and were concerned about learning to use the tools in improving CE in a company. The students also called for quizzes and *formative* (feed forward, supportive) assessment during the modules. They also wanted field visits to industries applying CE, and hoped for interactive tasks during lectures. In addition, as the modules are part of a research and development network, the students expressed a wish to be able to collaborate with others from different universities, mentioning e.g. the use of Virtual Reality to make sharing the learning objectives more concrete.

One of the most unexpected results was the obvious expectation to learn soft skills and working in groups when attending a learning module in CE. This relates to the dimension of working life/application.

6 Discussion

6.1 General

Engaging the learners right from the beginning of the learning module showed to be an engaging approach: the students felt engagement through the opportunity to do “learning crafting” and participating in e.g. the formative assessment practices during the course. This kind of engagement has been shown to have a strong correlation with student achievement (e.g. persistence and learning outcomes; Pascarella and Terenzini, 1991; Tinto, 2007). According to the teachers, the student engagement practices changed their courses for the better. This was partially due to creating a safe space and sense of belonging in the students. The engagement gave the teachers the ability to make visible that some of the concerns can be solved by immediate adjustments to the course arrangements. In the deeper interviews, we expect to find out more about the pedagogical implications and connections with active and flipped learning that this engagement approach can produce in curricular work, student engagement and eventually also academic achievement.

Virtual Realities are being planned to be applied when students from different countries go on the same learning modules simultaneously, sharing learning objectives and working on conceptual and material artifacts (Hakkarainen et al., 2004), essential for the real-life cases provided by collaborating industries. The developing pedagogical approach can also lead to identifying implicit new student expectations, central to working life competencies, such as soft skills as in this case.

6.2 Educational implications

The student engagement has several practical implications for education. First, it obviously gives the teacher a quick and close-to-zero way of understanding the concerns with which the students come to take a course. Solving at least some of the most salient concerns and communicating about it to the students can relieve the stress and uncertainty, factors that hinder deep learning and engagement. Second, the mere act of engaging the students in discussing the course contents and possibly also making them agents in laying out the criteria for student assessment has positive impacts on student interest and well-being (see e.g. Tinto, 2007). Third, group discussions based on anonymous submission of concern or ideas makes it possible to do evidence-based decision-making in a participatory manner, thus supporting a sense of belonging and respect created by communal practices and engagement in affecting what is learnt and how.

References

Aksit, F., Niemi, H., & Nevgi, A. 2016. Why is active learning so difficult to implement: The Turkish case. *Australian Journal of Teacher Education*, **41**(4).

<http://dx.doi.org/10.14221/ajte.2016v41n4.6>

Bergmann, J., Sams, A. 2012. *Flip Your Classroom: Reach Every Student in Every Class Every Day*. International Society for Technology in Education.

Bishop, J., & Verleger, M. 2013a. Testing the flipped classroom with model-eliciting activities & video lectures in a mid-level undergraduate engineering course. *Proceeding of Frontiers in Education Conference, FIE*.

Bishop, J. L., & Verleger, M. 2013b. The flipped classroom: A survey of the research. *Paper presented at Proceedings of 120th ASEE Annual Conference & Exposition, Atlanta, GA*.

Bocken, N., Short, S. W., Rana, P., & Evans, S. 2014. A literature and practice review to develop sustainable business model archetypes, *Journal of Cleaner Production*, **65**:42–56. DOI: [10.1016/j.jclepro.2013.11.039](https://doi.org/10.1016/j.jclepro.2013.11.039)

Boring, A., Ottoboni, K., & Stark, P. B. 2016. Student evaluations of teaching (mostly) do not measure teaching effectiveness. *Science Open Research*. DOI: 10.14293/S2199-1006.1.SOR-EDU.AETBZC.v1

Bound, K., & Thornton, I. 2012. Our Frugal Future: Lessons from India's Innovation System. Nesta Org. Retrieved [15.2.2020] at: https://media.nesta.org.uk/documents/our_frugal_future.pdf

Dyllick, T., & Hockerts, K. 2002. Beyond the Business Case for Corporate Sustainability. *Business Strategy and the Environment*, **11**, 130 – 141.

Emery, C., Kramer, T. and Tian, R. 2003, Return to academic standards: a critique of student evaluations of teaching effectiveness, *Quality Assurance in Education*, **11** (1), 37-46. <https://doi.org/10.1108/09684880310462074>

Foldnes, N. (2016). The flipped classroom and cooperative learning: Evidence from a randomised experiment. *Active Learning in Higher Education*, **17**(1), 39–49. <https://doi.org/10.1177/1469787415616726>

Hakkarainen, K., Palonen, T., Paavola, S., & Lehtinen, E. 2004. *Communities of networked expertise: Professional and educational perspectives*. Amsterdam: Elsevier.

Jagati, O. P. 2011. Business Strategy through Frugal Innovation. *Chartered Secretary*, **41**(11) 1533–1535.

Karabulut-Ilgü, A., Jaramillo Chérrez, N. and Jahren, C.T. 2018. A systematic review of research on the flipped learning method in engineering education. *Br J Educ Technol*, **49**: 398-411. doi:10.1111/bjet.12548

Kaspar, J., Baehre, D., Vielhaber, M. 2016. Material Selection Based on the Product and Production Engineering Integration Framework. *26th CIRP Design Conference. Procedia CIRP*, **50**, 2-7.

- Kasurinen, H., Uusitalo, V., Väisänen, S., Soukka, R., & Havukainen, J. 2017. From sustainability-as-usual to sustainability excellence in local bioenergy business. *Journal of Sustainable Development of Energy, Water and Environment Systems*, **5**(2), 240–272.
- Kemp; B: W., & Kumar, G: S. 1990. Student Evaluations: Are We Using Them Correctly?, *Journal of Education for Business*, **66** (2), 106–111, DOI:10.1080/08832323.1990.10535618
- Kim, M.K., Kim, S.M., Khera, O. & Getman, J., The Experience of Three Flipped Classrooms in an Urban University: An Exploration of Design Principles, *The Internet and Higher Education*, **22**, 37–50. doi:10.1016/j.iheduc.2014.04.003
- Kolb, D. A. (1984). *Experiential learning: Experience as the source of learning and development* (Vol. 1). Englewood Cliffs, NJ: Prentice-Hall.
- Korhonen, J., Honkasalo, A., & Seppälä, J. 2018. Circular Economy: The Concept and its Limitations, *Ecological Economics*, **143**, 37–46.
- Korhonen, J., & Seager, T. P. 2008. Beyond Eco-Efficiency: a Resilience Perspective. Editorial. *Business Strategy and the Environment*, **17**, 411–419.
- Lombardi, B. M. M., & Oblinger, D. G. (2007). Authentic Learning for the 21st Century: An Overview. *Learning*, **1**, 1–7.
- Nevgi, A., Virtanen, P., & Niemi, H. 2006. Supporting students to develop collaborative learning skills in technology-based environments. *British Journal of Educational Technology*, **37**(6), 937-947. doi:10.1111/j.1467-8535.2006.00671.x
- Niemi, H., & Nevgi, A. 2014. Research studies and active learning promoting professional competences in Finnish teacher education, *Teaching and Teacher Education*, **43**, 131-142. <https://doi.org/10.1016/j.tate.2014.07.006>
- Niemi, H., Nevgi, A., & Aksit, F. 2016. Active learning promoting student teachers' professional competences in Finland and Turkey. *European Journal of Teacher Education*, **39**(4), 471-490. <https://doi.org/10.1080/02619768.2016.1212835>
- Pascarella, E. T., & Terenzini, P. T. 1991. *How College Affects Students: Findings and Insights from Twenty Years of Research*. San Francisco, CA: Jossey-Bass.
- Prieto-Sandoval, V., Jaca, C., & Ormazabal, M. 2018. Towards a consensus on the circular economy. *Journal of Cleaner Production*, **179**, 605-615.
- Radjou, N., & Prabhu, J. 2014. *Frugal Innovation: How to do More with Less*. London: Profile Books.
- Sandström, N. , Nevgi, A. & Nenonen, S. 2019. Participatory service design and community involvement in designing future-ready sustainable learning landscapes. *In IOP Conference*

Series: Earth and Environmental Science. vol. 297, IOP Publishing, Bristol, SBE19 Sustainable Built Environment, Helsinki, Finland 22/05/2019. <https://doi.org/10.1088/1755-1315/297/1/012031>

Stephenson, T. J., Stephenson, L., & Mayes, L. (2012). Engaging Students in Service Learning through Collaboration with Extension: A Recipe for Success with Community Partners, *NACTA journal*, **56**(4), 78–84.

Tinto, V. 2007. Research and practice of student retention: What next? *Journal of College Student Retention*, **8**(1): 1–19.

WCED - World commission on environment and development (world council on environment and development). 1987. *Our Common Future*, Oxford University Press, New York.

Circular Design project. Educating the Design Community in Sustainable Design

J. Segalas¹, A. de Eyto², M. McMahon², Y. Bakirlioglu², G. Tejedor¹, B. Lazzarini¹, S. Celik³, A. Jimenez⁴ and J. Martens⁵

¹Research Institute for Sustainability Science and Technology, UPC – Barcelona Tech, Barcelona, Spain

jordi.segalas@upc.edu

² Design Factors, School of Design, University of Limerick, Republic of Ireland

³Stichting NHL, Leeuwarden. Netherlands.

⁴Nut Creatives, Barcelona, Spain.

⁵Ceci N'est Pas Une Holding B.V., Netherlands.

Abstract

Design has a key role to play in developing innovative solutions to current challenges – approaches that must consider the needs of end users and integrate sustainability criteria in processes and strategies for creating products and services.

The Circular Design Project (<http://circulardesigneurope.eu/>) is a European project funded by Erasmus+ Knowledge Alliance within the social business and the educational innovation field. The goal of this Circular Design project is to promote sustainable production and consumption of products and services in Europe. The project have four objectives: to increase and improve the learning strategies of Design for Sustainability, identifying opportunities for sustainably designed products and services as well as business opportunities in both higher education institutions and industries in Europe; To gather and cluster open educational resources and training courses for industry staff and academics in Innovative Design for Sustainability; To train up innovative and entrepreneurial designers who are capable of dealing with a transition towards Design for Sustainability as a mainstream design approach, as well as to promote cooperation and mobility with the EU's partner countries; and to establish a basis for a permanent and active European Network of Design for Sustainability.

This was achieved through a knowledge co-creation process and the development and pilot training materials in order to teach and train students, faculty and enterprise staff of the design sector.

The project formed by 12 partners is organised around four country hubs in Ireland, The Netherlands, Catalonia and Sweden. Each country Hub consists of one university with education and research in Sustainable Design, one Design company with expertise in sustainable Design and one national design association. The project main results are:

- The Open Educational Resources database (<http://circulardesigneurope.eu/oer/>) where resources in Circular design are clustered in three taxonomies: Categories (First-timers; Practitioners), Level (Beginner; Intermediate; Advanced) and Tags (calculator; report; ...).

- The Best Practice Publication, shows the whole design process, materials, challenges, problems and other key issues of Circular Design case studies within sectors like technology, furniture, clothing, lighting or packaging, to demonstrate that circular design strategies can be applied to improve the efficiency of almost every system.
- Four international one semester internships for undergraduate design students in the four universities involved in the project with the participation of 11 companies and 45 students.
- The Circular Design Digital Fabrication Lab Handbook to introduce students, companies and academics to the open-source, participatory, experimental and design & build approach within digital fabrication labs.
- The Professional Development Course in circular design.
- The Policy Paper in Circular Design Education

1 Introduction

The Circular Design - Learning for Innovative Design for Sustainability (L4IDS) project (<http://circulardesigneurope.eu/>) is a three year (2016-2019) Erasmus + Knowledge Alliance financed project.

The consortium consisted of 12 partners (4 Universities with education and research in Design and Sustainable Design, 4 Design Companies with expertise or interest in Sustainable Design and 4 Design association of the country) organised around country hubs (Table 1).

Table 1: Circular Design Partnership.

Country hub	Catalonia	Ireland	Sweden	The Netherlands
University	Universitat Politècnica de Catalunya	University of Limerick	Linköping University	NHL University of Applied Sciences
Company	NutCreatives	One-Off	Habermann	Ceci N'est Pas Une Holding B.V
Design professional body	Barcelona Centre de Disseny	Institute Designers Ireland	Swedish Industrial Design Foundation	House of Design

The goal of the project is to promote sustainable consumption and production of products and services in Europe. This is achieved through a knowledge co-creation process and the development of training materials, through Open Educational Resources (OER), in order to teach and train students, faculty and enterprise staff of the design sector in Innovative Design for Sustainability (IDfS) strategies (Figure 1). The project is aligned with European Circular Economy policies and contributes to the realization of a more sustainable society.

The evolution of the DfS field has broadened its theoretical and practical scope over the years (Ceschin *et al.*, 2016). While the first approaches of the early 90's, were focusing predominantly on the technical approaches of sustainability (Adams *et al.*, 2016), the following ones have recognized the crucial importance of the role of users, resilience of communities, and more generally of the various actors and dynamics of socio-technical systems (Joore, 2010; Joore & Brezet, 2015). This evolution has been accompanied by an increased need for human-centred design knowledge and know-how. Initial DfS approaches related to the product innovation level predominantly requiring technical knowledge and

knowhow. On the other hand, more recent DfS approaches require designers to be provided with a different set of expertise. For example techniques to gather insights from users, news ways of satisfying customers and techniques to co-design with them are essential (Adams *et al.*, 2016). The project presented here aims at influencing the overall system, from the physical product to the socio-technical level.

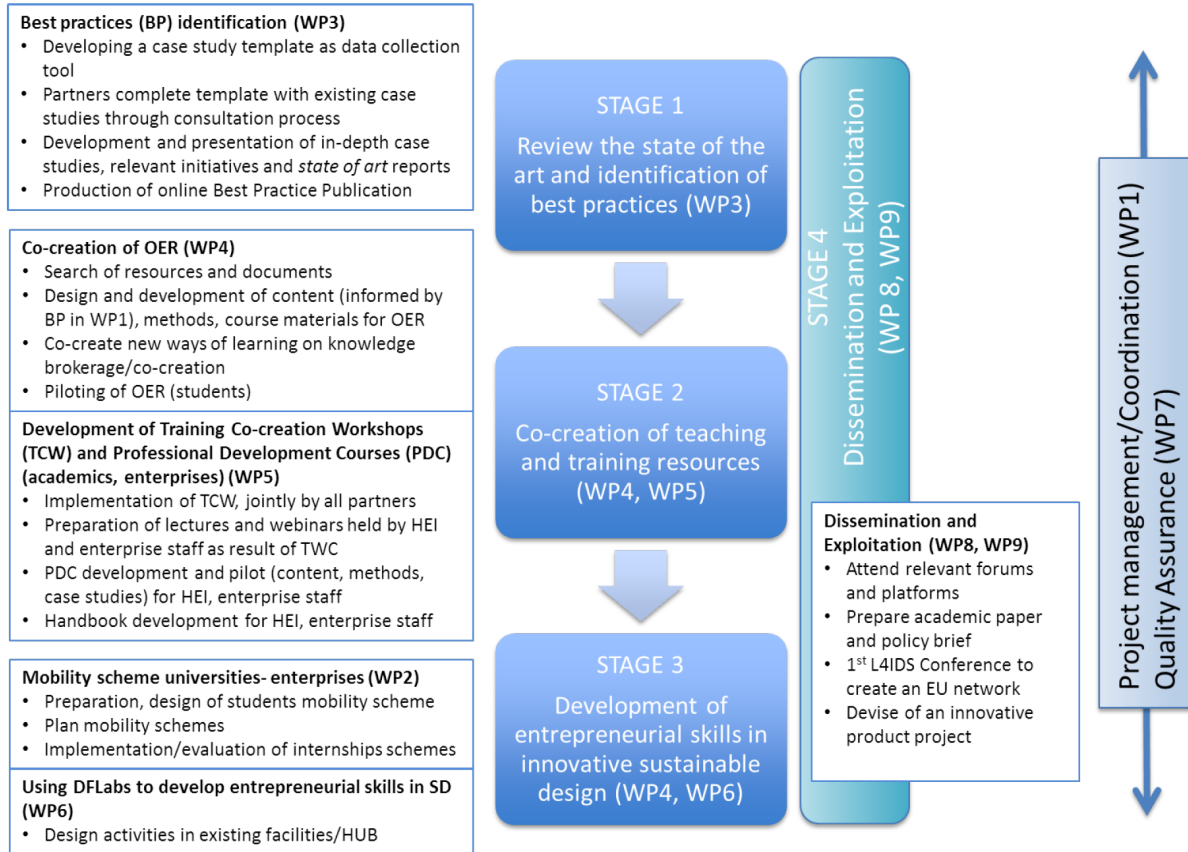

Figure 1: Circular Design – Learning for Innovative Design project rationale.

To map the position of potentially new educational tools and methods, this research builds on the overview of previous initiatives around DfS in higher education which some of the consortium partners have been involved with researching (See section 2). By mapping these initiatives on the triangle Design for Sustainability (DfS) - Knowledge Co-Creation – Innovation we have articulated the gap which the Circular Design project aims to bridge. As a basis for this inventory, the DfS evolutionary framework has been used (Figure 2).

2 Overview of design for sustainability in higher education

The concept of sustainable design as a specialism within design, business and manufacturing is not a new one. Writers and educators such as Victor Papanek (1971) and Buckminster Fuller (1969) were advocating a change in the way we taught students how to design and look at the world in which they live. In parallel with this, many other experts (Carson, 1962; Lovelock, 1979) were highlighting the difficulties being caused by industrialization and global trade in the natural environment. Issues such as the dramatic impact of the global population on ecosystems; the strains on the global and local economic systems and the challenges meted by social inequity were starting to be raised by scientists, economists and even designers

as early as the 1960s. These are now finally accepted as real problems for today’s students and professionals and for the world as a whole. They now provide clear opportunity both to graduates and to businesses as fields in which they can provide and develop expertise with a view to mitigating past and future problems.

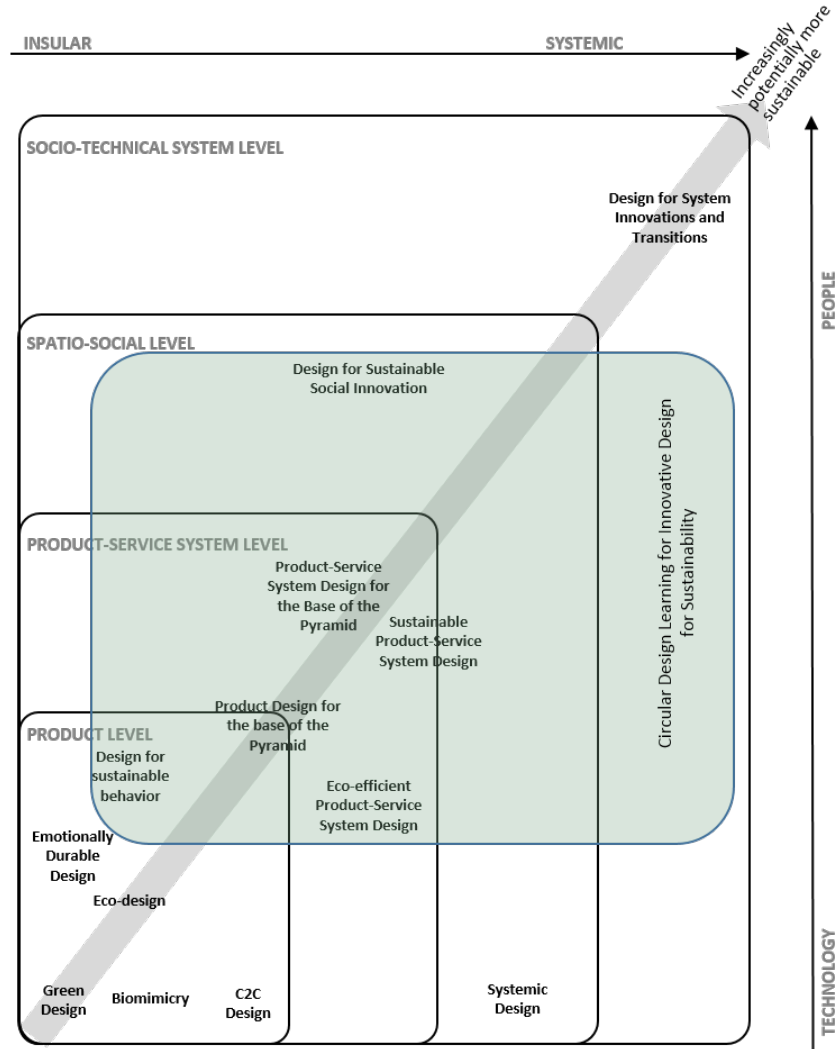

Figure 2: Circular Design Project within the DfS evolutionary framework (Segalas *et al.*, 2017).

3 Objectives

The overall objective of the project is to promote sustainable consumption and production of products and services in Europe. To achieve this main goal during the project the partnership co-create open-source training materials, and organised four international internships for design students in order to teach and train students, faculty and enterprise staff of the design sector in Innovative Design for Sustainability (IDfS) strategies (Figure 1).

The project co-created training materials are:

- Best Practice Publication
- Open Educational Resources Database
- International Internships for students scheme
- Professional Development Course and handbook for capacity building and
- Policy Brief in Circular Design Education
- Digital Fabrication Lab handbook for Circular Design.

4 Methodology

The methodology applied is participatory action research. We carried out 3 co-creation workshops with the participation of 29 companies, 45 design students and 40 design academics, where the different outcomes were discussed and agreed. Moreover the different training resources has been piloted and assessed in the sequential four internships during the three years of the project.

5 Results

The Project is structured around the tangible expected outcomes structured in work packages. Next sub-sections show the results achieved. All results can be downloaded from the project website: <http://circulardesigneurope.eu/>

5.1 Best Practice Publication

NutCreatives partner was in charge of coordinating the ideation, prototyping and publication of best case studies publication (Figure 3). Relevant case studies, based on real company successful experiences have been released and disseminated along the duration of the project, and eventually collected in an e-book. Emerging and consolidated companies of diverse fields have been collaborating drafting the case studies. Aside from specific results and the great quality of the final product, the insights resulting from these collaborations processes among the different companies involved were of invaluable contribution for the project experience and for the companies themselves.

The eleven case studies represent the diversity of sustainable designed products and services in Europe. They are from really different sectors like technology, urban furniture, waste management, clothing and accessories, food packaging or furniture to show how sustainable design strategies can be applied in every sector. The result is a collation of well implemented business models based in excellent products, showing the creative process and the strategies that made them innovative and profitable.

We put a lot of energy into the creation of infographics that allow different levels of reading, to illustrate the different process and methodologies in a clear way. This includes concept maps, icons, tags, etc. but also longer texts that show the information achieved during the interviews. The Publication contains 11 case studies:

1. **Sea2see**: a change agent in the eyewear industry
2. **Transparent speaker**: a future proof strategy for the technology sector

3. **Mamukko**: Ecoinnovation thanks to a new material combination.
4. **Novell coffee capsules**: a family-owned company rethinking its business model
5. **Frisian sweater**: sustainable design strategies for the clothing industry
6. **Vectorial system**: improving accessibility with a sustainable product
7. **2.31 Recycled carbon chair**: ecoinnovation enabled by a new production process
8. **Deterra by Tierra**: world's First 100% Bio-Based and fossil-free technical Jacket
9. **Relaja**: an urban furniture system that gives value to a waste material in small local economies.
10. **Cool Downlight**: finding sustainability in searching for efficiency
11. **R11 New Logic chair**: a big compendium of strategies to produce a long-lasting and sustainable product

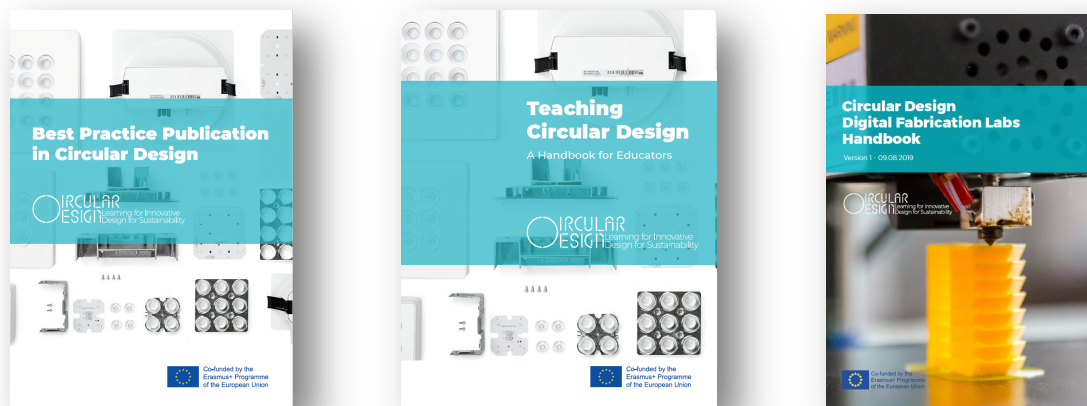

Figure 3: Best Practice Publication; Circular Design Handbook and DFlab publications

5.2 *Circular Design Open Educational Resources Database.*

A database collating tools and methods for Design for Sustainability and Circular Economy, presenting them in different and easy-to-navigate categories was made available through the project website, and widely disseminated to different stakeholders. The database was designed to be consulted according to different levels of expertise, from first-timers to experts. Furthermore, the technical design of the database allows researchers, educators and practitioners to easily upload and share with the design community their OERs through the portal.

5.3 *International Internships scheme for Circular Design*

The universities involved in the project developed an International Internship program for Circular Design with an adoptable schedule conforming to the structures of these universities. The aim of the program is to promote a culturally-diverse, interdisciplinary working environment for students from varying backgrounds (i.e. Product Design, Business, Materials Science).

To develop the internship the action research approach was used as developing an adaptable Circular Design internship program, where different institutions from different cultural backgrounds and pedagogical perspectives are involved and the development of the program, requires reflection of the involved

researchers on the existing design education. Hence, in line with the action research cycle steps of reflection, planning and action (McNiff & Whitehead, 2006), the collaborative action research framework in Figure 4 was developed.

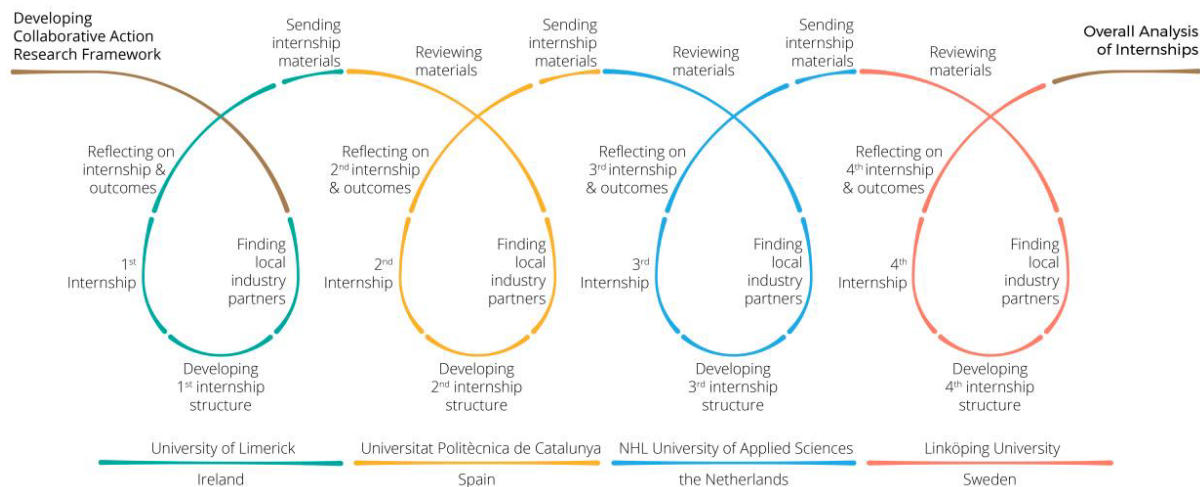

Figure 4: Collaborative Action Research Framework developed indicating the internship cycles. (Adapted from Bakirlioglu et al., 2018)

5.4 Professional Development Course and Handbook for Circular Design

Based on the experience and knowledge gained through project outcomes - and specific co-creation workshops held jointly with university and enterprises in the different partners' countries - an online handbook (Figure 3) aimed at guiding knowledge co-creation processes among staff of university and enterprise in IDfS have been published. This training resource aims at providing universities and design enterprises a selection of useful resources, strategies, training methods and step-by-step recommendations in order to engage with IDfS in professional practices and to foster entrepreneurial skills in this specific field. The content of this handbook has been drafted as a working base to develop/structure professional development courses on IDfS

5.5 Policy Brief in Circular Design Education

A policy brief based on the project's outcomes has been drafted and disseminated. This outcome constitutes a call for action aimed at integrating Circular Design in policies of the European Union particularly addressed to Circular Economy. Specifically, it states that circular design thinking and development should be implemented throughout all of European policies and sectors: i) starting with education in schools and universities; ii) offering a lifelong learning covering all sectors, including policy makers and iii) continuously adding high level sustainable development for all professionals and business types.

5.6 DFLab handbook for Circular Design

The handbook (Figure 3) is an introductory guide to bring together digital fabrication labs (e.g. FabLabs, hackerspaces, makerspaces, etc.) and the related practices enabled through digital knowledge sharing into

design education for sustainability and Circular Economy. It introduces terms of these newly espousing fabrication spaces and the communities around them, potentials of these spaces for sustainability and Circular Economy. The contents of this handbook were used as a base for delivering masterclasses as part Circular Design Internships conducted during the project.

6 Acknowledgements

We like to thank all companies, students and faculty that have collaborated with this project. Special thanks to the Erasmus+ Key Action program: Cooperation for innovation and the exchange of good practices. Action Type: Knowledge Alliances for higher education for funding the project.

References

- Adams R., Jearnrenaud D., Bessant J., Denyer D. & Overy P. 2016. Sustainability-oriented innovations: A systematic review. *International Journal of Management Reviews*, 18(2), 180-205.
- Bakirlioglu, Y., McMahan, M., Eyto, A. & Rio, M. 2018. Training the next generation of designers for a sustainable future: action research on the circular design internship. A: Design Research Society. "Design Research Society 2018 Catalyst: DRS 2018".
- Carson R. 1962. *Silent spring*, Boston: Houghton Mifflin.
- Ceschin F. & Gaziulyosy, I. 2016. Evolution of design for sustainability. From product design to design for system innovations and transitions. *Design studies*, 47, 118-163.
- Fuller R. & Snyder J. 1969, *Operating manual for spaceship earth*, Southern Illinois University Press Carbondale, Illinois.
- Joore P. 2010. *New to Improve, The Mutual Influence Between New Products and Societal Change Processes*, (PhD Thesis), 2010 (Delft: Technical University of Delft).
- Joore P. & Brezet H. 2015. A multilevel design model: The mutual relationship between product-service system development and societal change processes, *Journal of Cleaner Production*, 97, 92-105.
- Lovelock J. 1979. *Gaia a new look at life on earth*, Oxford University Press.
- McNiff, J. & Whitehead, J. 2006. *All You Need to Know About Action Research*. London: Sage.
- Papanek V. 1971. *Design for the real world, human ecology and social change*, London: Thames & Hudson.
- Segalas, J.; DeEyto, A.; McMahan, M.; Joore, P.; Crul, M.; Wever, R. & Jimenez, A. 2017. Circular Design. Learning for innovative design for sustainability: Erasmus + knowledge Alliance Project for Sustainable Design. International conference on Engineering and Product Design Education. pp. 18. Oslo. Norway.

Sustainability Shares in the Classroom

David C Shallcross¹

¹Department of Chemical Engineering, University of Melbourne, Australia

dcshal@unimelb.edu.au

Abstract

Safety shares, safety moments or toolbox talks are a way to keep process and personal safety at the front of mind. Within many industries every meeting, no matter what the topic, begins with a safety share, safety moment or toolbox talk, a chance to reflect on the importance of safety. The safety discussion might last for only 2 to 4 minutes and might be drawn from personal observation or experience or from readings. This practice has been replicated in one subject in the chemical engineering program at the University of Melbourne for seven years. A safety share begins every lecture. Safety shares, when implemented in a careful manner, allow students to be introduced to concepts such as permit-to-work, confined spaces, the hazards of static electricity and the importance of maintaining situational awareness.

If the use of safety shares has proved to be an effective way to raise the level of awareness of personal and process safety, then this technique can be expanded to promote the importance of sustainable development in the future. Lectures could begin with sustainability shares that introduce students to the key concepts. If safety shares can help promote a strong safety culture with a department or school, then the use of sustainability shares should be able to do the same.

In this paper the concept of sustainability shares is developed with 11 shares being proposed for use in the chemical engineering classroom. These shares cover topics including issues around energy equity in less developed countries, to the amount of embodied water and energy in some everyday items. By presenting one sustainability share a lecture, three lectures a week for a semester, almost 40 shares will be delivered by each subject helping students to understand the role that chemical engineers can play in addressing the issues of sustainable development.

1 Introduction

During the first decade of this century professional engineering institutions and associations have begun to recognize that engineering graduates must possess a strong and sound understanding of sustainable development concepts. Graduates will also need to understand that throughout their professional lives as engineers, many of their decisions will need to be guided by principles of sustainable development. In 2007, the UK-based Institution of Chemical Engineers released “A Roadmap for the 21st Century Chemical Engineering”, a document that looks to the future of the chemical engineering profession (Institution of Chemical Engineers, 2007). An important observation made in the report is that the “... education of future generations of chemical engineers and realignment of the current generation with sustainability objectives is a vital component of the process of sustainable development.” The report’s authors also noted that the way in which sustainable development is taught in universities in the 2000s should be questioned just as the way concepts around safety were questioned in the late-1970s following the Flixborough accident in

1974 (Khan and Abbasi, 1999). Subsequent, updated versions of the IChemE's report including "chemical Engineering Matters" released in 2012 reemphasized the importance of sustainable water, energy and food as well as societal health and wellbeing.

In 2010 a number of leading engineers from around the world, sponsored by the United States National Academy of Engineering (2010), developed a list of fourteen grand challenges for the engineering profession as a whole for the 21st century. Five of these fourteen challenges are directly related to sustainable development – solar energy economics, energy from fusion, carbon sequestration methods, clean water access and managing the nitrogen cycle.

While the engineering profession on many levels now recognizes the importance of the philosophy of sustainable development professional accreditation bodies such as ABET in the US, Engineers Australia in Australia and ASIIN in Germany are silent as to how sustainable development concepts should be incorporated into the engineering curriculum.

In many ways sustainable development may be addressed in the engineering curriculum in fashions very similar to how concepts of personal and process safety and loss prevention are addressed in the chemical engineering curriculum. Both can be addressed through the use of standalone subjects that are delivered and assessed independently of all other content in the program, or the concepts may be integrated throughout the entire program. In this latter approach, the importance of sustainable development is emphasized in the first year of the program with concepts and relevant techniques being developed, leading towards some form of capstone project in which the key concepts learned must be applied. Whether standalone subjects are used or a more integrated approach is adopted, student learning may be reinforced through a school and university culture that recognizes the importance of sustainable development – a culture in which all institution staff behave in a manner that upholds the principles of sustainable development.

2 Safety Shares

The last two decades have seen the adoption of a practice throughout many industries in which safety is discussed at the start of every meeting, no matter what the topic of the meeting. The person running the meeting typically invites participants to share any safety-related issue or incident. These issues or incidents can be drawn from personal experience or from their wider knowledge. These discussion points, known as safety shares or tool box talks, may only last up to 5 minutes, but they act to keep safety at the front-of-mind.

The practice of opening every meeting with a safety share has been replicated by the author in every lecture in their undergraduate chemical engineering subject for the past seven years. Every one of these lectures has commenced with a short safety share of between 2 to 4 minutes (Shallcross, 2014). Although the students were advised that the contents of the safety shares would not be assessed they were advised that the shares would help them moving forward in their careers. A good safety share is one that students can easily relate to, not requiring specialist technical knowledge. Two simple safety shares are:

- 1) Methanol burns with a colourless flame. If any methanol is spilled then care must be taken approaching the pool of methanol. The methanol might be alight, but the only way someone can tell that is by the

heat given off. People have been burned as a result of a simple methanol pool fire as the flame is invisible.

- 2) In all facilities that process petrochemicals flare stacks are used to safely burn off the petrochemicals in an emergency. In the event of sudden loss of power, loss of process control or a blockage in a line that leads to a surge in pressure, the entire plant can be depressurised by dumping the liquids and gasses in the processing vessels and pipes to the flare. The radiant heat given off by the combustion of the petrochemicals at the flare can be so great that anyone in the vicinity of the flare at the time the chemicals are ignited risks severe burns. As the flare can be triggered without warning, entry into the area surrounding the flack stacks is usually strictly forbidden whenever the processing facility is in operation.

Over 50 other safety shares are presented by Shallcross (2014).

During 2013 and 2014 students enrolled in the class were asked to participate in a voluntary survey to gain insight into their opinions on the effectiveness of the safety shares to raise the awareness of safety in the profession. Using a paper-based, anonymous survey students were asked to state the extent to which they agreed or disagreed with a series of ten statements. A 5-point Likert scale was used in which a value of 1 was assigned to the response “Strongly disagree” while a value of 5 was assigned to “Strongly agree”. The ten survey questions as well as the average responses from 107 respondents are presented in Table 1 (Shallcross 2014).

Although the results of this survey are described more fully in the 2014 paper it is useful to note here several key points:

- 1) every student agreed to some extent that chemical engineering graduates need a strong appreciation of the importance of safety;
- 2) 95 % of respondents recommended that the next time the subject was taught that safety shares be again incorporated into the start of the lectures; and,
- 3) less than 5 % felt that the safety shares were a waste of time.

The student response has been so strong that the practice has now spread to other subjects within the program.

3 Sustainability Shares

Given the success of the safety shares in raising the awareness of safety and safety-related issues amongst chemical engineering students it is reasonable to suspect that beginning some lectures with short discussion points related to sustainable development might be useful in promoting this important topic.

A series of short sustainability shares have been developed that may be used in the engineering class room to promote thought and possible discussion outside the lecture theatre. These are being tested during 2020 to determine their effectiveness in raising awareness of some of the key issues around energy, water and resource scarcity. Eleven of these shares follow.

Table 1 : Summary of survey responses with average score determined using a 5-point Likert scale.

Question	Average Score
Q1. I recommend that next time CPA1 is taught that the safety shares are again used to begin each class.	4.56
Q2. Chemical engineering graduates need a strong appreciation of the importance of safety.	4.78
Q3. I enjoyed hearing about the safety incidents described in the shares.	4.39
Q4. I would have liked the opportunity to participate more in the shares by sharing my own safety stories.	3.04
Q5. I did not pay much attention to the safety shares as they were not assessable material.	2.08
Q6. The safety shares were a waste of time. I would have preferred to get straight on with the lectures.	1.66
Q7. Most of the safety shares were interesting.	4.27
Q8. I would have liked to hear more safety shares.	3.80
Q9. The safety shares were a good way to introduce us to the importance of safety in the work place.	4.59
Q10. The safety shares were a good way to remind us of some of the dangers of working in chemical processing plants.	4.64

3.1 Bitcoin mining

Bitcoin mining currently accounts for around 0.2 % of the electricity consumed around the world. Iceland is a global hub for bitcoin mining and it is expected that in 2020 the amount of electricity consumed by this one area of e-commerce will surpass Iceland's entire household electricity demand (International Energy Agency, 2018).

3.2 Billions of cars and trucks

The world's fleets of cars and trucks increased from around 800 million in 2000, to 1350 million vehicles in 2017. China alone accounted for an increase in over 100 million vehicles during this period, with strong growth also occurring in India and Latin America. By 2040 the world's vehicle fleets are predicted to pass 2 billion cars and trucks. The introduction of electric vehicles together with more fuel-efficient cars will mean that the demand for oil by road transport vehicles will only increase by 10 % over the period from 2017 to 2040, (International Energy Agency, 2018).

3.3 The legacy of offshore platforms

Since the world's first offshore oil platform not connected to land by a pier was built off the coast of California in 1932, over 16,000 offshore structures have been put into place for use in extracting oil and gas from subsea petroleum reservoirs. At the end of their useful lives these structures must be decommissioned and completely removed, with the seafloor being returned to its unobstructed state. The presence of so many structures that will eventually have to be removed, is a huge liability for the industry and society, and one that is often forgotten by the general public.

3.4 Power generation until 2040

As the global demand for power generation rises from 6960 GW in 2018 to an estimated 12480 GW in 2040, there will be a shift to more renewable energy sources. Despite the reduction in coal-based power generation in many Western countries, power demand is such that there will still be a nett increase in coal derived power generated until at least 2040.

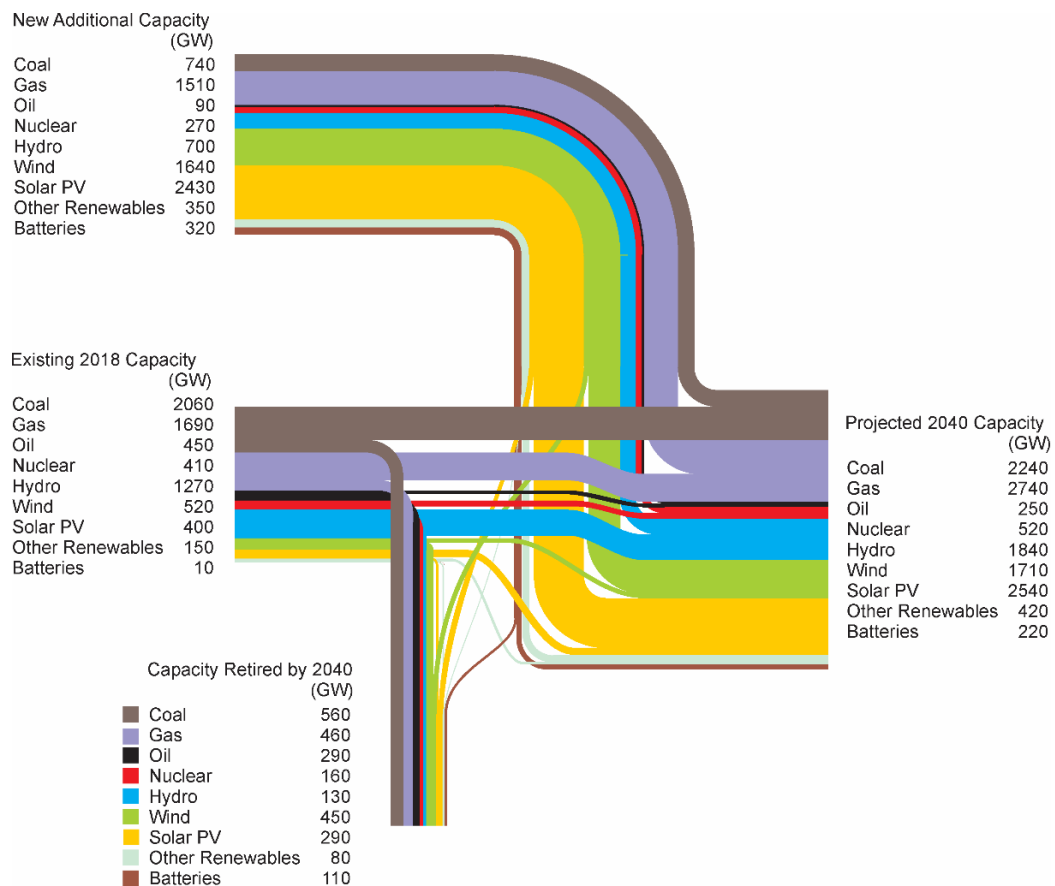

Figure 1 : Between 2018 and 2040 a large amount of generating capacity to be added around the world, while some will be retired. More than half the new capacity will come from renewable sources. Figure adapted from International Energy Agency (2018).

3.5 Data centre energy demands

The huge growth in the number of internet-connected devices around the world has led to a surge in the demand for electricity, not only to power these devices, but also to power the data centres associated with the use of these devices. In 2015 the world's data centres used around 191 TWh of electricity, representing about 1 % of the world's global consumption of electricity. Fortunately, the strong growth in demand for data centre services is countered by improved efficiencies in the way in which the centres are run. It is estimated that data centre power usage will remain stable at around 191 TWh until at least 2021, however beyond that time predictions cannot be made (International Energy Agency, 2018).

3.6 Recycling gold

What is the ultimate recyclable material? The answer is gold as throughout human history its value has been so high that it has never been thrown away – it is always recycled. The gold in the wedding ring my wife gave me might have been formed into a larger ring that was kept in a family as an heirloom for 150 years making its way from Spain to Australia in the 1970s. Before that the gold might have been mined in Russia and then traded as ingots, before being sold to a jeweller. Today gold is used in the electronics industry to create better electrical contacts. With mobile devices being disposed of without the gold being recovered, today, for the first time in history gold is being thrown away with little chance of recovery.

3.7 Energy consumptions rates in 2017

In 2017 the average worldwide energy consumption was 74.9 GJ per person per year (Figure 2). The per capita consumption rate for China is increasing and is now above the world average. If the per capita rates in China and India increase significantly then the demand on the world's energy resources will be overwhelming (Shallcross, 2020).

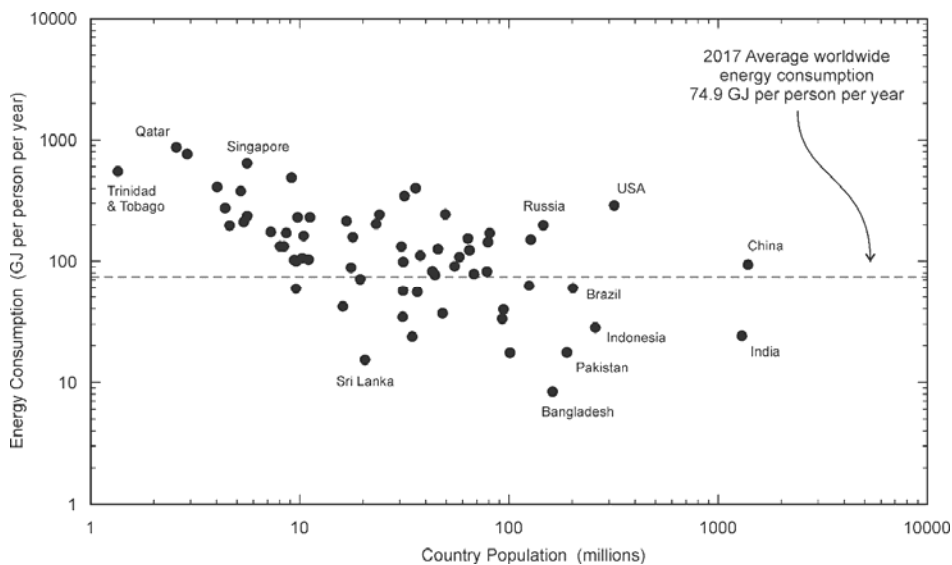

Figure 2 : Average energy consumption per person per year in 2017 for each country over 1 million, for which data is available (Shallcross, 2020).

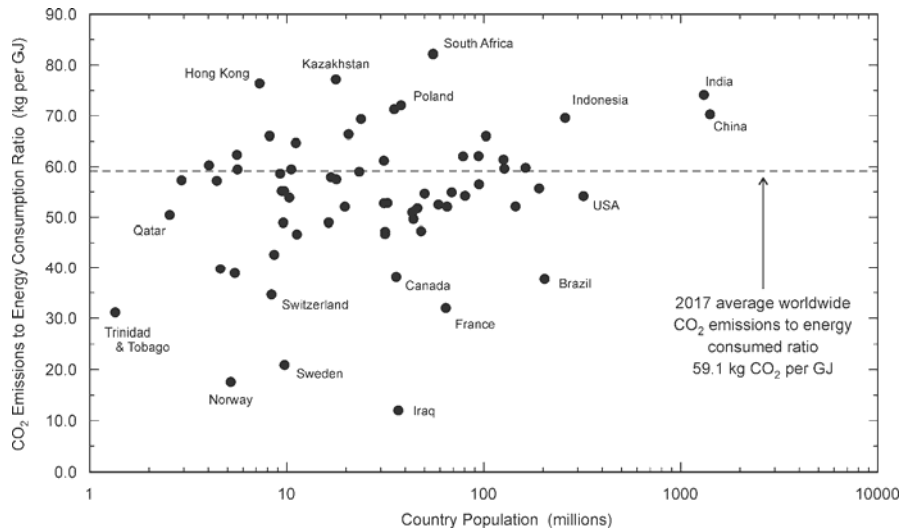

Figure 3: Average annual production of CO₂ emission to energy consumed for each country expressed in kg per GJ (Shallcross, 2020).

3.8 CO₂ production rates in energy production

Some countries produce their energy more cleanly with less CO₂ production than others. Figure 3 shows the average annual ratio of CO₂ emissions to energy consumed for each country with a population over 1 million, and for which data is available. France's high reliance on nuclear energy generates little CO₂, while other countries have a greater reliance on coal. (Shallcross, 2020).

3.9 Water for breakfast

How much water did you have for breakfast? If we include the embodied water in the two eggs (392 litres), the two slices of bacon (998 litres), the two slices of bread (146 litres), the pad of butter spread on the bread (28 litres) and the cup of tea (27 litres), then 1591 litres of water were embodied within the food. This does not include, however, the energy to cook the food, or boil the water for the tea. These are average values and may vary significant between locations.

3.10 Water footprint of different meats

It has been calculated that to produce 1 kg of beef for human consumption requires 15,400 litres of water, while lamb requires 10,400 litres of water per kg of meat, but pork only requires 6,000 litres of water per kg of meat. Chicken typically requires just 4,300 litres of water per kg of meat, just a quarter of the amount for beef. These figures will vary for different locations (Mekonnen and Hoekstra, 2012).

3.11 Availability of the elements

Whether it is lithium for batteries or platinum for catalysts some elements will increasingly become scarcer as the level of demand approaches supply levels. Figure 4 shows that within the next 100 years the availability of some elements such as zinc and silver will be seriously threatened.

		Abundant										Limited availability with future risk to supply																							
		Demand rapidly increasing to meet supply										Serious threat to availability in next century																							
H	1											B	C	N	O	F	Ne																		
Li	3	Be	4											5	6	7	8	9	10																
Na	11	Mg	12											13	14	15	16	17	18																
K	19	Ca	20	Sc	21	Ti	22	V	23	Cr	24	Mn	25	Fe	26	Co	27	Ni	28	Cu	29	Zn	30	Ga	31	Ge	32	As	33	Se	34	Br	35	Kr	36
Rb	37	Sr	38	Y	39	Zr	40	Nb	41	Mo	42	Tc	43	Ru	44	Rh	45	Pd	46	Ag	47	Cd	48	In	49	Sn	50	Sb	51	Te	52	I	53	Xe	54
Cs	55	Ba	56	57-71	Hf	72	Ta	73	W	74	Re	75	Os	76	Ir	77	Pt	78	Au	79	Hg	80	Tl	81	Pb	82	Bi	83	Po	84	At	85	Rn	86	
Fr	87	Ra	88	89-103	Rf	104	Db	105	Sg	106	Bh	107	Hs	108	Mt	109	Ds	110	Rg	111	Cn	112	Nh	113	Fl	114	Mc	115	Lv	116	Ts	117	Og	118	
		La	57	Ce	58	Pr	59	Nd	60	Pm	61	Sm	62	Eu	63	Gd	64	Tb	65	Dy	66	Ho	67	Er	68	Tm	69	Yb	70	Lu	71				
		Ac	89	Th	90	Pa	91	U	92	Np	93	Pu	94	Am	95	Cm	96	Bk	97	Cf	98	Es	99	Fm	100	Md	101	No	102	Lr	103				

Figure 4 : Periodic table showing the future availability of some of the elements.

4 Concluding Remarks

Safety shares have proven to be useful in propmoting the importance of safety within the chemical engineering student community. It is anticipated that well developed sustainability shares will also prove to be useful in reinforcing concepts taught in other classes in an engineering program. Sustainability shares will be introduced into the chemical engineering classrooms in a second year subject during the 2020 academic year in order to test their value. The results of this trial will be presented later.

References

- Institution of Chemical Engineers. 2008. A Roadmap for 21st Century Chemical Engineering, Institution of Chemical Engineers, Rugby, UK.
- International Energy Agency. 2018. World Energy Outlook 2018. <https://www.iea.org/reports/world-energy-outlook-2018> (accessed 10 February 2020).
- Khan, F.I. and Abbasi, S.A. 1999. Major accidents in process industries and an analysis of causes and consequences. *Journal of Loss Prevention in the Process Industries*, **12**, 361-378.
- Mekonnen M.M. and Hoekstra A. 2012. A global assessment of the water footprint of farm animal products. *Ecosystems*, **15**(3).
- National Academy of Engineering. 2010. Grand Challenges for Engineering, <http://www.engineeringchallenges.org/> (accessed 10 February 2020).
- Shallcross D.C. 2014. Safety shares in the chemical engineering class room, *Education for Chemical Engineers*, **9**(4), 94-105.
- Shallcross D.C. 2020. *Petroleum Engineering Explained*. Royal Society of Chemistry.

A New Course on Sustainable Innovation and Entrepreneurship

Pritpal Singh, PhD

Department of Electrical and Computer Engineering, Villanova University, USA

Pritpal.singh@villanova.edu

Abstract

The UN Sustainable Development Goals (UN SDGs) provide a number of challenges in addressing poverty worldwide. To create momentum towards achieving these goals and the sub-goals (or targets), in many cases developing entrepreneurial solutions may be the best approach. We have developed and offered a new course based on an experiential learning pedagogy to educate students on creating entrepreneurial solutions to the UN SDGs.

The course begins with an overview of the UN SDGs and an introduction to entrepreneurship. The course then focuses on ideation and opportunity identification for solutions addressing one of the SDGs. The students are then introduced to the business model canvas, including the Presidio graduate school extension that enhances the Business Model Canvas by adding questions specifically related to sustainability considerations of the business model development. The next step in the course development is teaching the students how to develop minimum viable products through a process of rapid prototyping. In parallel with the formal teaching and activities in the classroom, the students are required to develop a venture concept outside the classroom. This concept is posted to a discussion board where the students' peers and the professor are asked to provide feedback to the students posting their venture ideas. The next step in the course is to go through a customer discovery process in which students are asked to learn from potential customers what are the customers' pains, difficulties that they are looking for solutions. Again, the results of these interviews with potential customers are posted on the course discussion board for peer and professor review and feedback. The business model and concept is refined by the students and then the students move into a customer validation phase where they talk to a number of potential customers/early adopters to refine their prototype solution. Finally, the students are then taught how to develop a sales strategy and to actualize some sales of their products.

The course work is supported by local expertise including a sales consultant, a logo design/branding expert, a supply chain expert, and experts in corporate structures, venture financing and intellectual property. The students present their final product/service design, their venture strategy, and sustainability metrics that they will use to gauge the performance of their ventures specifically against the sustainability aspects of the solution.

This paper will present more details of the activities conducted in the class, a description of the student learning outcomes and how well they were achieved and plans on further developing the course based on student feedback.

1. Introduction

The United Nations laid out an updated set of Sustainable Development Goals (UN SDGs) in 2015 that superseded the Millennium Development Goals that expired in the same year [1]. There are seventeen goals and 169 targets to be achieved by 2030 that address areas such as clean water and sanitation, affordable and renewable energy, quality education, good health and well-being, etc. Many of these goals are very

ambitious, such as “provide access to clean and affordable energy to everyone in the world.” As we enter the fifth year of the 15-year time frame to achieve the goals, we are still lagging behind on many of them [2]. Most development programs are funded through international aid programs, international non-governmental organizations (NGOs) or through government programs. Yet, these are primarily grant funded projects and have little consideration for bringing solutions to scale [3]. An approach that has a greater likelihood of success in achieving these goals is to consider entrepreneurial solutions. There are many examples of how social enterprises have been able to contribute to sustainable development in a large scale. One such example is that of Green Light Planet [4] that has developed a line of portable solar electric systems to provide clean electricity access to rural communities.

Recognizing the important ways in which entrepreneurially minded thinking can lead to the development of scalable solutions to address the UN Sustainable Development goals, we embarked on the preparation of a postgraduate class on this topic to educate students who specialize in the International Development Track of the Masters in Sustainable Engineering at Villanova University. The subsequent sections of this paper describe the content of the course, the different innovations and business models that resulted from the first iteration of teaching the class, and lessons learned.

2. Course Structure

The course was titled “Sustainable Innovation and Entrepreneurship” and was a semester long (15-week course). There were three course objectives defined as, by the end of the course, the students should have:

- 1) Understood and applied the entrepreneurial mindset through experience to addressing a UN SDG challenge;
- 2) Analyzed and evaluated opportunities for identification of a viable business opportunity related to the UN SDGs;
- 3) Created an initial venture concept with product/market fit to address a UN SDG challenge.

Recognizing that the students in the class were mostly Master’s and PhD students in the Sustainable Engineering program, only about 20% of the course was focused on sustainable engineering concepts and the remaining 80% of the course was focused on the entrepreneurship concepts. With this focus in mind, the textbook selected for the course was “*The Start Up Owner’s Manual*” by S. Blank and B. Dorf [5], a “manual” to entrepreneurs who are interested in starting their own business. The week-by-week breakdown of topics covered in the course are given in Table 1.

The class started with a presentation of the historical evolution of the UN SDGs starting with the Millenium Development Goals. The students were introduced to the issues and challenges that the developing world faces and gave examples of solutions that failed because of not being developed through a holistic perspective (e.g. the Playpump). This topic was followed by an introduction to entrepreneurship. The coverage in this topic included understanding the different types of enterprises (e.g. small businesses, social enterprises, etc.), what is meant by value proposition, and common pitfalls made by inexperienced entrepreneurs.

The next topic covered in the course was to help students consider the opportunities for innovations in the sustainable development space. Several ideation techniques including brainstorming, painstorming, lateral thinking, biomimicry, etc. were described and the students were then given scenarios to which to apply the techniques in an activity during the class period. This approach was used to illustrate the utility of the different approaches.

Table 1. Week-by-week topical coverage

Week Number	Topic(s) Covered
1	Review of UN SDGs; Introduction to Entrepreneurship
2	Ideation and Opportunity Identification related to the UN SDGs
3	Introduction to customer discovery; value proposition
4	Rapid Prototyping; Minimum Viable Product design;
5	Introduction to the Business Model Canvas (including the Presidio Extension)
6	Intellectual Property (Guest speaker)
7	Customer Discovery I: Stating Business Model Hypotheses
8	Customer Discovery II: Understand the Customer
9	Customer Discovery III: Test the Solution
10	Sales/Marketing/Customer Validation I
11	Sales/Marketing/Customer Validation II
12	Customer Validation III/Sales Metrics
13	Impact Assessment, Sustainability Metrics
14	Invited entrepreneur (Guest speaker)
15	Student Presentations

An important concept for new entrepreneurs is that of a minimum viable product (MVP). The idea of rapid prototyping and creating a MVP was presented next. Having an initial prototype to share with potential customers is an important way for entrepreneurs to refine their product design in a short time with a relatively low investment of funds. The next topic covered was the business model canvas. Introduced by Osterwalder and Peigneur [6], this is a useful tool to experiment with different business model concepts. An enhancement to the Business Model Canvas that allows sustainability considerations to be added to the tool was developed by the Presidio Graduate School in Michigan [7]. This enhancement was also presented during the discussion of the Business Model Canvas tool. Homework and in-class exercises were developed for the students to gain practice with the use of these tools.

The next three classes covered the topics of customer discovery. They were designed to show students how to engage with potential customers. The first step in this customer discovery phase was to apply active listening skills to better define what the potential customer likes/dislikes about the business model, prototype, etc. The second step is then to refine the business model/concept to better align with meeting the needs of the customer. The third step is then to reevaluate the modified solution by again engaging with the potential customer. In these segments, several videos of how to engage customers were presented, particularly ones developed and presented by Steve Blank. As an in-class exercise, the students were asked to role play potential customers and entrepreneurs and practice the skills being taught in the class.

The next two classes were focused on how to sell to potential customers. A guest speaker who runs her own sales and marketing consulting company was brought in as a guest speaker for this class along with a branding expert who talked about logo design. As homework exercises, the students were asked to develop

a logo and a sales pitch for their proposed business ventures and present it to the class. The other students in the class were then asked to provide peer feedback.

As the students were progressing along in the class, they were asked to start thinking about developing a business venture that targeted a specific UN SDG. They were asked to post their business concepts on the course management system (Blackboard) website and provide peer feedback to their peers. Part of their final grade was based on how engaged they were in class discussions as well as in providing peer feedback in the Blackboard site.

Following the instruction on how to engage with potential customers, and having received feedback from the instructor and the students' class peers, they were asked to find at least 10 potential customers, five who they knew and five who they did not know, to get feedback on their business ideas. They were then able to use this feedback to refine their business concepts.

The final topic of the class was a discussion of social return on investment (SROI) assessment. The SROI approach was chosen since it is a well-developed methodology and is a very appropriate approach for the social enterprises that the students were developing.

In addition to the topics mentioned above, we had a guest speaker talk about sustainable supply chains and a young entrepreneur talk about his journey to date on the entrepreneurial path. This latter talk was particularly effective for the students because it underscored many of the topics covered throughout the semester.

The final deliverable for the class was a proposal that the students had to prepare in the format of the IEEE SIGHT project proposals. IEEE is the professional society of electrical, electronic and computer engineers and is the largest engineering professional organization with a global membership of >400,000 engineers. The Special Interest Group in Humanitarian Technology (SIGHT) program supports IEEE volunteers who wish to engage use their technical skills to address any of the UN sustainable development goals in their local communities [8]. In addition to addressing the SIGHT proposals, the students were also asked to prepare and include in their final reports a completed business model canvas, including the questions from the Presidio extension. In addition to a final report, the students had to present their ventures in front of the class and get feedback from the instructors, guest visitors and their class peers.

3. Pedagogical Approach and Resources Employed

The course was taught using a number of tools. Videos, particularly inspirational or example videos of startup companies working in the sustainable development space, were employed in the class presentations. The present course development was funded by a grant from Venture Well [9], an organization that promotes technology-based innovation and entrepreneurship on college and university campuses in the US. They have several videos that are accessible through their website that highlight startup companies that have been supported through their grants. An example of such a video highlights Ecovative Design, a company that has developed a mushroom-based material for sustainable packaging [10].

Another set of useful videos that were employed in the teaching of the class were ones from Steve Blank's website [11]. These short videos are very focused and provide a good lesson in each video.

A number of exercises were also assigned to the students as activities to be performed during the class period related to the various entrepreneurship topics. All the in-class exercises were focused on sustainable development challenges. An example of such an in-class activity was having the students go through a rapid prototyping exercise on bringing clean water to members of a developing world community.

Finally, as mentioned earlier, having guest speakers come in and give presentations on topics such as sustainable supply chain, starting your own company, intellectual property, sales, logo development, etc. provided more subject matter expertise for specific topics.

4. Student Ventures coming out of the class

The students developed several business ideas, and some are moving forward on further developing their startup ventures. Three ventures are provided here as examples.

4.1 Sustainability Software Tool

The first venture that was actually started prior to the course was based on a Master's thesis. It is a software tool that allows organizations, such as companies, universities, etc. to do a comprehensive assessment of their performance over the 17 UN SDGs. Based on the data that is input into the software tool, recommendations are made for actions that may be taken by the organization to improve their scores in achieving the different UN SDG goals.

4.2 Trashpacks

This company was started by a student who lives near the beach and has been frustrated with seeing so much trash lying around as she jogs in the area. Her concept was to develop a portable trash can that can be carried as a backpack while running. As one sees trash, they can put it into the can that in her "trashpack". A picture of her conceptual prototype is shown in Figure 1.



Figure 1. Trashpacks prototype

4.3 Solar Confidence for Solar Disinfection (SOCO for SODIS)

The third example venture coming out of this class was developed by a team of four students, two Sustainable Engineering Master's students, and two electrical engineering postgraduate students. The issue that they were addressing was how to know whether dirty water placed in a plastic bottle and being disinfected by UV radiation from sunlight is clean enough to drink. They developed an electronic device for accumulating the UV radiation over time and when a threshold has been surpassed, a green indicator light would come on to indicate that the water is safe to drink. This project won an award last year in a global innovation competition and a proposal to develop and commercialize the technology has been submitted to Venture Well for an e-teams grant.

5. Student Feedback and Lessons Learned

This course received some very positive comments from the students. Given that it was the first time that the course was offered, it went quite smoothly. A couple of the students' comments were:

"The course structure and the assigned projects require the student to apply what is learned towards actual venture development. I found this to be very effective in understanding the material as I was learning by doing."

"I really enjoyed the class and learned a lot"

"I felt that the course started off strong and then somewhat fell flat halfway through. I felt that there was an inordinate amount of time spent on "selling" and talking to potential customers."

Overall, the course went well. However, I agree that some additional topics (e.g. startup accelerator programs) and additional guest speakers could have enhanced the class. On the other hand, while some students complained about having to engage with potential customers, understanding the customer, learning to actively listen to a potential customer and then getting feedback from potential customers is an extremely important skill that startup entrepreneurs need to develop.

6. Conclusions

This paper has presented details on a new course on Sustainable Innovation and Entrepreneurship that was taught this past fall term. The main audience for this class was Sustainable Engineering graduate students. The class focused on educating students on how to develop entrepreneurial ventures to address sustainable development challenges. The course included a number of topics on entrepreneurship and used an active learning approach where students applied their knowledge gained in the class lectures into the ventures that they were developing. Several startup companies have come out of the course and are now being advanced by the students. Further mentoring support will be provided over the coming few months as the students move their ventures forward.

7. Acknowledgements

The author is grateful for financial support from a faculty grant from the Venture Well organization to develop and implement this course. The author is also very grateful to Matthew Peterson, a postgraduate student in the Masters in Sustainable Engineering program who helped to develop the course materials for the class.

8. References

- [1] UN Sustainable Development Goals
<https://www.un.org/sustainabledevelopment/sustainable-development-goals/> [Accessed February 16, 2020]
- [2] <https://www.un.org/sustainabledevelopment/monitoring-and-progress-hlpf/> [Accessed February 16, 2020]
- [3] "Entrepreneurship and the Sustainable Development Goals", Eds. N. Apostopolous, H. Al-Dajani, D. Holt, P. Jones, and R. Newbery Emerald Publishing Ltd. (2018)
- [4] Green Light Planet www.greenlightplanet.com [Accessed February 16, 2020]
- [5] "The Startup Owner's Manual", S. Blank and B. Dorf, K&S Ranch Publishing, 2012

- [6] “*Business Model Generation*, A.Osterwald and Y. Pigneur, John Wiley & Sons, 2010
- [7] Business Model Canvas Sustainability Booster [https://www.presidio.edu/wp-content/uploads/2017/10/Business-Sustainability-Booster PGS_FINAL.pdf](https://www.presidio.edu/wp-content/uploads/2017/10/Business-Sustainability-Booster_PGS_FINAL.pdf) [Accessed February 16, 2020]
- [8] IEEE SIGHT www.sight.ieee.org [Accessed February 16, 2020]
- [9] Venture Well www.venturewell.org [Accessed February 16, 2020]
- [10] Ecovative Design ecovativedesign.com [Accessed February 16, 2020]
- [11] Steve Blank’s website <https://steveblank.com/> [Accessed February 16, 2020]

Sustainable Approaches to the Management of Innovation and Technology in Engineering (SAMITE II)

Iain Duncan Stalker¹, Rinkal Desai² and Rachel Studd³

¹Institute of Management, University of Bolton, Bolton BL1 1SW

I.Stalker@bolton.ac.uk

²WMG, University of Warwick, Coventry CV4 7AL

³Department of Materials, The University of Manchester, Manchester M13 9PL

Abstract

Engineering gives rise to some of the most vibrant and fast-paced industries in the world; yet, these industries and innovations can exact a heavy price, impacting people and the planet in the procurement of profits. Growing awareness of environmental issues and concerns over the cumulative environmental impact of extraction, manufacturing and transport have provoked increasing demands for accountability and responsibility; there is a groundswell of opinion that industries must be more transparent. The innovation of new, more sustainable practices cannot be done in isolation: practitioners must work with other professionals, if the needs of all stakeholders are to be respected and embraced.

To address contemporary challenges and create a more sustainable world, graduates must know whom to speak with, why and about what. As a key step towards this, we present a framework to provide a holistic perspective on the intersections of the various value chains that obtain in engineering, manufacturing and product development; this framework makes explicit the many paths through which products and services are created and developed, through what we term ‘innovation trajectories’; and the (artificial and natural) contexts from which these draw; this in turn helps to identify key partners from professions and stakeholder groups. Knowing whom one needs to engage with and why directly supports softer skills that are an essential foundation of an effective professional engineering practice. Thus, we also consider this framework a useful mechanism to inform the discussion around employability and professional competence.

1 Introduction

Engineering gives rise to some of the most vibrant and fast-paced industries in the world; innovations arise at all stages, from ground-breaking industrial processes and novel materials promising new commercial opportunities, to disruptive business models affording new ways of realising these. But these industries and innovations can often exact a heavy price, impacting people and the planet in the procurement of profits; cf. Elkington (1997) and Savitz and Weber (2006). Growing awareness of environmental issues and concerns over the cumulative environmental impact of extraction, manufacturing and transport have provoked increasing demands for accountability and corporate responsibility (Horrigan 2010). Indeed, there is a groundswell of opinion that industries must be more transparent in their practices and proactively seek to replace the traditional “take-make-waste” model with a ‘Circular Economy’ (MacArthur 2019).

Responsibility in manufacturing, distribution and use is not a novel idea in Engineering, cf. Life-Cycle Analysis (e.g., Ashby 2005); and engineers themselves are precisely the professionals to rectify such

imbalances: reconciling and resolving contradictions is fundamental to an engineer's mindset; recall, for example, TRIZ (Altshuller 2006). Such redress requires the “creative destruction” of established processes (Schumpeter 1934) and the innovation of new, more sustainable practices. And this cannot be done in isolation: engineering systems, and *a fortiori* engineering itself, are systems within larger system; thus, practitioners must work in teams with other professionals to accommodate the needs of all stakeholders, i.e., those affected by the outputs—concepts, systems, products—of their industries. Quite simply, to create a more sustainable world, engineering graduates must know whom to speak with, why and about what.

As a key step towards this, we present a framework that extends the SAMITE workspace of Stalker, Desai and Studd (2011) to provide a holistic perspective on the intersections of the various value chains that obtain in engineering, manufacturing and product development; this framework makes explicit the many paths through which products and services are created and developed (what we call “innovation trajectories”) and the (artificial and natural) contexts from which these draw; this in turn helps to identify key partners from professions and stakeholder groups. Knowing whom one needs to engage with and why directly supports softer skills that are an essential foundation of an effective professional engineering practice. Thus, we also consider this framework a useful mechanism to inform the discussion around employability and professional competence; cf. Knight and Yorke (2004) and Dacre Pool and Sewell (2007).

In Stalker *et al* (2011) we presented SAMITE, a framework for systematically managing innovation and technology in textiles. We have since enriched the underlying thinking with explicit recognition of sustainability that obtain within this framework and have extended our application to the support of courses, projects and education in other areas, including engineering. Here, we seek to present the fundamentals of the framework as it currently stands and outline its application. The structure of the paper is as follows: in Section 2, we clarify “management of innovation” and elaborate “sustainable approach”; in Section 3, we present our workspace, identifying the ingredients that combine in its construction

2 Background

2.1 Innovation and Management

Our starting point is the definition of the *management of innovation* offered by Bruton and White (2011, p.379): a “comprehensive approach to managerial problem solving and action based on an integrative problem-solving framework, and an understanding of the linkages between innovation streams, organizational teams, and organization evolution”. We underline the need for an ‘integrative problem-solving framework’ with explicit ‘linkages’: our attention framework embraces these aspects. Innovation is the synthesis of technology and business: both are fundamental to innovation; cf. Schumpeter (1934). The ‘innovation arena’ of Janzsen (2000) comprises four key aspects—technology, application, markets (or user groups) and organisation (the TAMO combination)—to make explicit this synthesis; see Figure 2. He uses this to both frame the context that must be considered when studying innovation and to delineate the scope of the innovation activities. Thus, to truly understand innovation requires a holistic view of the TAMO combination; moreover, the interactions of the TAMO combination evolve over time tracing out ‘innovation trajectories’¹: for example, new technology is used to create a new application, which in turn

¹ Traditionally, the innovation trajectory is drawn beginning at the market axis: this is not to suggest that all innovations begin there.

creates a new market; this in turn may stimulate new organisational forms to better exploit the potential of this.

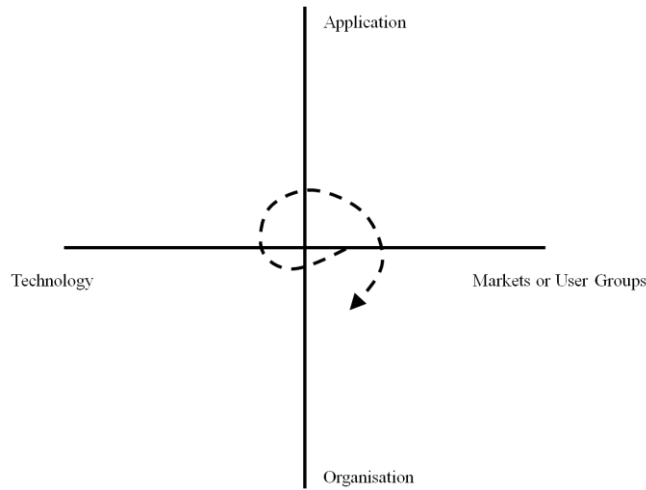

Figure 1: The Innovation Arena (TAMO) [after Janzsen (2000)]

Recognising the need to continually assess the impact and influence of drivers from each aspect of the TAMO combination motivates a framework that explicitly identifies the components of each aspect in sufficient detail to allow these influences to be traced.

2.2 Sustainable Development and the Circular Economy

There are many uses of the terms ‘sustainability’ and ‘sustainable development’; perhaps the most oft-cited definition of sustainable development is that of the Brundtland report (WCED 1987): “development which meets today’s needs without compromising the ability of future generations to meet theirs” (p. 41).

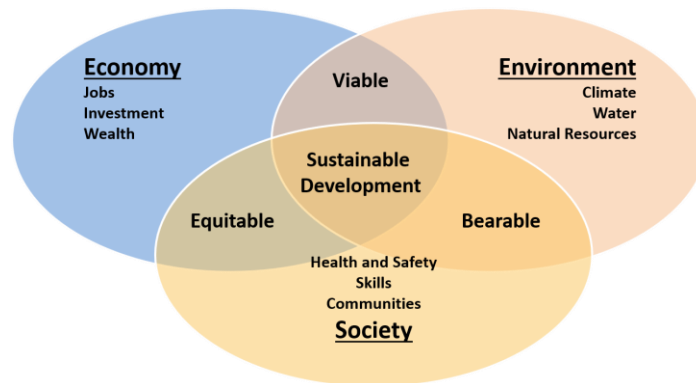

Figure 2: Sustainable Development

While this presents a useful starting point, we prefer a more wholistic conceptualisation that recognises the three pillars of Elkington (1997), see Figure 2: unless there is explicit consideration of the needs of people (society) and economic viability in conjunction with responsible curation of the environment, we will not have a truly sustainable approach; cf. the observation of *inter alia* Savitz and Weber (2006) that sustainable development arises where “business interests and the interests of the environment and society intersect”.

3 The SAMITE Workspace

Our workspace draws on a number of primary sources which reflect our backgrounds of interaction and expertise; but it is built by elaborating upon and refining an ‘information structure for product design’ developed by Ashby and Johnson (2010, p.126), see Figure 3; this clarifies the interactions of various categories of information. While technical design, e.g. Ashby (2005), is motivated chiefly by the attainment of function, subject to minimum cost and required quality, safety, etc., excellent product design considers aspects such as appeal, ergonomics, usability, perceptions, etc.; broadly, *personality* and *usability*. These are essential to the development of successful products: great products function, satisfy and even delight.

A particularly appealing aspect of this structure is the clear separation of elements which procure the physical structure of the product—thus, the technical aspects—from those that combine to create an effect that stimulates, satisfies and pleases the target user; these are referred to as *physiology* and *psychology*, respectively. Naturally, these two areas interact: for example, the use of certain materials will serve to support aesthetic characteristics or perceptions, e.g. the use of polished metal to suggest high technology or woods to connote craftsmanship. Further, Ashby and Johnson (2010) make explicit the target market (*intention*) for the product: this will influence both the physiology and the psychology of the final product.

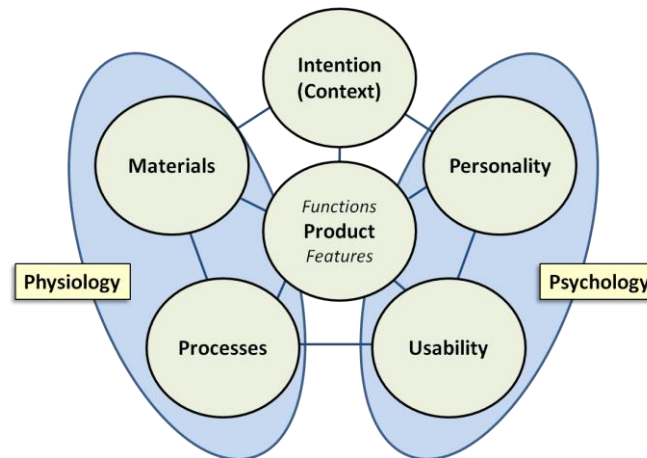

Figure 3: Product Design Information [after Ashby and Johnson (2010); cf. Ashby (2005)]

This structure provides the means to begin exploring the technology and markets aspect of the TAMO combination; the product itself can be used to understand the application areas. Yet, this represents only a starting point: notions of *personality* and *usability* do not always capture the engagement of an end consumer with the artefacts produced; moreover, very few products are sold as standalone items: there is typically a ‘wrapper’ of services and experiences. Thus, we extend the notion of a ‘product’ to include services and we distinguish business processes from manufacturing processes. We adopt the term ‘value proposition’ to denote products, services and combinations of these (so-called ‘product-service bundles’).

3.1 Elaboration of the Basis

Elaboration of the basis consists in the development of the structure of Ashby and Johnson (2010) using additional elements that complement and refine. These ‘extensions’ provide the means to characterise the psychology of goods, services and experiences; to provide elements that describe a physiology of product-

service bundles; and the direct inclusion of financial aspects such as revenue streams and cost structures. We developed these in Stalker *et al* (2011); thus, we move directly to an overview of the ‘workspace’.

3.2 Workspace: Framework, Innovation Trajectories and Spiralling

Our workspace comprises: a framework (see Figure 7) that coordinates elements essential to a full characterisation and understanding of a product-service bundle, its composition and interaction with users and markets; and ‘innovation trajectories’ that describe routes through the framework.

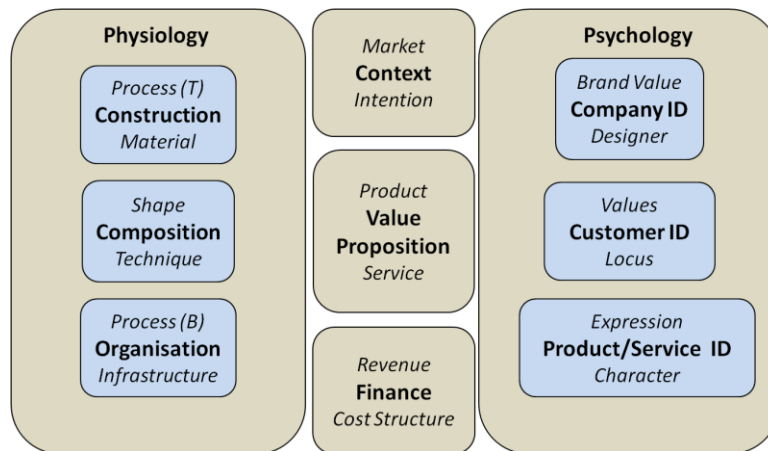

Figure 4: The SAMITE Workspace (Stalker *et al* 2011)

Value proposition denotes the bundle of products and services offered. It acts as a focal point of the framework, since it is the ultimate offering.

Physiology denotes the structural aspects of the value proposition; it comprises

- **Construction** which treats the physical form, material(s) and the technical process(es) employed.
- **Composition** which addresses design approach(es), specific shape(s) and technique(s) applied.
- **Organisation** which addresses the means through which the value proposition is brought to market; it also addresses the intangible analogue(s) of physical form for services; it consists in business processes and the organisational infrastructure or ecosystem.

Market captures the commercial context, identifying target customer(s), i.e. market(s), and design intention.

Finance captures the revenue stream(s) through which the value created will be appropriated and makes explicit the cost structure(s) involved in creating and delivering the value proposition.

Psychology denotes the intangible aspects of the value proposition; it follows the product expression model of Gotzsch (2006) and comprises Company ID, User ID² and Product/Service ID.

Fundamentally, the framework is a clarifying structure: it elucidates aspects to be evaluated and considered; it identifies potential roles where teams coordinate their efforts; and it gives suggestions of whom, i.e. what categories of experts, to approach to realise an innovation.

² Here, we use ‘locus’ to signify expressions of time, place, status and culture.

3.3 Innovation Trajectories

Innovation can arise in any area of the framework; we refer to the driver or motivator of an innovation as an ‘(innovation) epicentre’; cf. Osterwalder and Pigneur (2010). An ‘(innovation) trajectory’ is a path through the framework; it begins at an epicentre and visits each main area; it is descriptive rather than prescriptive or normative. Tracing possible trajectories clarifies how to bring an innovation to market, e.g. what to consider and whom to consult. Figure 5 illustrates two generic trajectories.

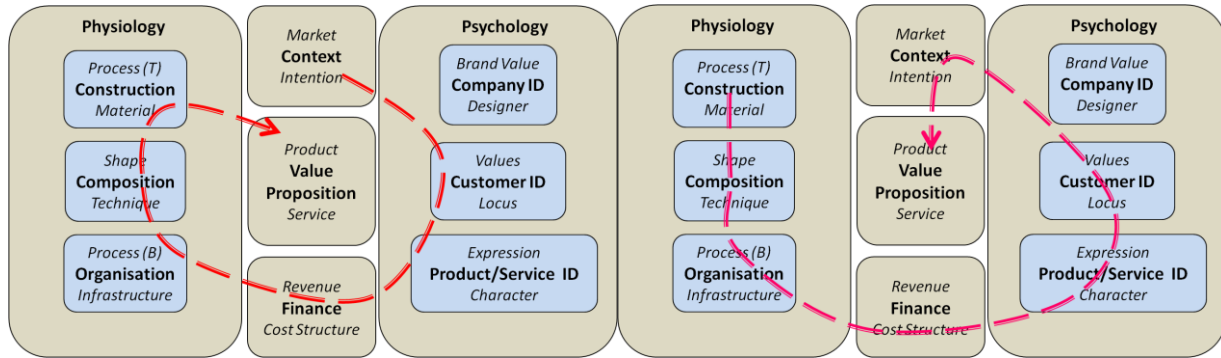

Figure 5: Market-Driven and Process-Driven Innovation Trajectories (Stalker *et al* 2011)

The left-hand side of Figure 5 illustrates a trajectory with an epicentre in ‘context’; specifically, from market intelligence and we refer to this as a ‘market-driven innovation trajectory’. The driver for the innovation is a new market opportunity. Here, a profile of the target customer is developed and used to define a product-service bundle to meet a potential demand. If the market opportunity can be clarified in terms of price, then the product-service bundle definition can be augmented with strategic pricing and an appropriate (target) cost structure. This cost structure is likely to influence the choice of business processes, composition techniques and the physical construction of the final offering. To refine the choices and decisions that will ultimately lead to the value proposition, the trajectory will be traced a number of times; each tracing provides opportunities to explore the economic viability of the value proposition, the social contribution and costs of the activities developing the value proposition and the environmental/ecological impact of delivering the value proposition. The right-hand side of Figure 8 illustrates a trajectory with an epicentre in ‘physiology’; specifically, from the development of a new (technical) process and we refer to this as a ‘process driven innovation trajectory’. Perhaps, this new process is more environmentally friendly, with lower carbon footprint or the reduced need for irrigation; it may require new composition techniques or provide the possibility of new shapes; these in turn may require a reorganisation of existing (business) processes or suggest the opportunity of new partnerships, leading to a revised infrastructure. Attendant cost structures need to be investigated to determine the most appropriate route to the development of new product-service bundle definitions and identification of profiles of customers most likely appreciate the potential offerings; this will be informed by intelligence regarding market opportunities. Again, to refine the choices and decisions that will ultimately lead to the final value proposition, the trajectory will be traced several times. Often, an innovation will unite and unify a number of developments; for example, a new market opportunity may coincide with the development of a new process, e.g., the more ethically minded consumer demands more sustainable fabrics that can be realised through the use of ‘newer’ fibres such as bamboo. In this case, we consider multiple trajectories from multiple epicentres and refer to the coordination of the individual trajectories into a single trajectory as ‘(innovation) trajectory alignment’.

These invite the coordination of efforts from different disciplines and gives a clear motivation for the need to educate the engineers and other graduates of the future in the context of product-service developments.

3.4 Summary Case Study: Electric and Hybrid Electric Vehicles

Innovation and sustainability unify in the development of electric and hybrid electric vehicles (EV/HEVs). The desire to reduce (urban) emissions has motivated significant investment in research into replacing internal combustion engines (ICEs) (DoT, 2020): EV/HEVs promise the means (Kumar and Alok, 2019).

Increasing adoption of EV/HEVs, suggests exploring this as a market-driven trajectory through the SAMITE workspace. With the market as the driver, and the strength of the brand and reputation for innovation (Company ID) will strongly influence offerings. A premium brand may introduce a new HEV alongside its existing range or perhaps deploy key technologies across multiple platforms to preserve the key characteristics of the products (Product/Service ID) in the perceptions of its key customer base (Customer ID). If the customer base is to be enlarged, then when retracing the trajectory, it would need to explore this part of the trajectory from Market to Psychology to Finance in depth. This provides a perfect opportunity to explore the three pillars of sustainability within an innovation trajectory: in particular, environment as a key driver with the constraint of retaining prestige in eyes of key customers to preserve economic viability. The brand would need to examine whether it could offer a suitably differentiated product (automobile) to justify the price point: would the EV/HEV ‘speak’ to the customer in the ‘same’ way? Does a branded EV/HEV convey the status (Product ID)? Jaguar Land Rover (JLR) has HEVs targeting the ‘premium’ customer (Product ID), which seem preserve the brand meaning (Company ID). The exploration of economic viability would also be informed by potential future revenue streams (Finance). For example, JLR is investing in its own battery power R&D initiatives and development, utilising the resources from its parent group, Tata Motors (Organisation); licensing offers a possible future revenue stream. Of course, the structure and production of cars with ICEs is different: there are significant changes in the elements of ‘physiology’ (Composition and Construction). Owing to space, we defer discussion.

4 Discussion: Communication and Employability

SAMITE provides a workspace to explore and clarify sustainable paths to the management of innovation. In a forthcoming work we present its application to further case studies across disciplines, including product development in aerospace and recyclable textiles. The notions of epicentre and trajectory afford the means to pursue the management of innovation in a systematic manner. These structures to foster communication; this is achieved in two stages: an explicit statement of the vocabulary of each area; and an alignment of these at interfaces. Making explicit the many paths through which products and services are created and developed and the (artificial and natural) contexts from which these draw helps to identify key partners from professions and stakeholder groups. Knowing whom one needs to engage with and why directly supports softer skills that are an essential foundation of an effective professional engineering practice; for example, it explicitly supports the ‘personal and professional skills’ components of the CDIO framework (www.cdio.org); the structures can be used to structure interdisciplinary project teams, which supports the ‘interpersonal skills’ component of the CDIO Framework (and of course other professional frameworks, such as UKSPEC). Thus, the SAMITE framework is a useful mechanism to inform the broader discussions around employability, contributing directly to development of a fuller understanding of the context of ones

subject, confidence in knowing how to assemble an appropriate team to address challenges, and reflection on the need to engage with stakeholders; cf. Understanding, Efficacy and Metacognition in the USEM model of Knight and Yorke (2004).

References

- Altshuller, G (2006). *And Suddenly the Inventor Appeared. TRIZ, the Theory of Inventive Problem Solving*. Eighth Printing. Worcester, MA: Technical Innovation Center, Inc.
- Ashby, M F (2005). *Materials Selection in Mechanical Design (Third Edition)*. Oxford, UK: Elsevier.
- Ashby, M and Johnson, K (2010). *Materials and Design. The Art and Science of Material Selection in Product Design*. Oxford, UK: Elsevier.
- Bruton, GD and White, MA (2011). *Strategic Management of Technology and Innovation (Second Edition)*. South-Western/Cengage.
- Dacre Pool, L and Sewell, P (2007). The key to employability: developing a practical model of graduate employability. *Education and Training*. Vol. 49 No. 4, pp. 277-89.
- DoT (2020). *Decarbonising Transport: Setting the Challenge*. Department for Transport. Available at: https://assets.publishing.service.gov.uk/government/uploads/system/uploads/attachment_data/file/878642/decarbonising-transport-setting-the-challenge.pdf. Accessed 22/05/2020.
- Elkington, J (1997). *Cannibals with Forks: the Triple Bottom Line of 21st Century Business*. Oxford, UK: Capstone.
- Gotzsch, J (2006). Product Talk. *The Design Journal*. 9(2): 16-24.
- Horrigan, B (2010). *Corporate Social Responsibility in the 21st Century: Debates, Models and Practices Across Government, Law and Business*. Cheltenham, Glos, UK: Edward Elgar Publishing.
- Janzen, F (2000). *The Age of Innovation*. Edinburgh, UK: Prentice Hall.
- Knight, PT and Yorke, M (2004). *Learning, curriculum and employability in higher education*. London: Routledge Falmer.
- Kumar, RR, and Alok, K (2019). Adoption of electric vehicle: a literature review and prospects for sustainability. *Journal of Cleaner Production*: 119911.
- MacArthur (2019). *Concept. What is a Circular Economy?* MacArthur Foundation. <https://www.ellenmacarthurfoundation.org/circular-economy/concept>. Accessed 22/05/2020.
- Osterwalder, A and Pigneur, Y (2010). *Business Model Generation*. Hoboken, New Jersey: John Wiley & Sons.
- Rubenstein, AH (1989). *Managing Technology in a Decentralized Firm*. New York: Wiley.
- Savitz, AW and Weber, K (2006). *The Triple Bottom Line*. San Francisco, CA: Jossey-Bass/Wiley.
- Schumpeter, J (1934). *The Theory of Economic Development*. Cambridge, MA: Harvard University Press.
- Stalker, ID, Desai, R and Studd, R (2011). "SAMITE: Systematic Approaches to the Management of Innovation in Textiles". *Proceedings of Management of Innovation in Textiles*. Textile Institute. November.
- WCED (1987). *Our Common Future (The Brundtland Report), World Commission on Environment and Development*. Oxford, UK: Oxford University Press.
- Zeisel, J (1984). *Inquiry by Design*. Cambridge, UK: Cambridge University Press.

Nature knows better?

Nature as exemplar and/or inspiration?

Laura (L.L.) Stevens², Karel (K.F.) Mulder^{1,2}, Helen (H.N.) Kopnina², Marc (M.J.) De Vries¹

¹Delft University of Technology, Delft, the Netherlands

²The Hague University of Applied Sciences, The Hague, the Netherlands

laura.l.stevens@gmail.com

Abstract

The arising of the industrial society and the growth of human population have been main causes of resource depletion, climate change and the decline of ecosystems. Industrial systems and technologies have brought economic and public health progress, leading to an unprecedented population in relatively good conditions. But often, the new technologies that enabled this development turned out not to be the miracle solutions that they had been claimed to be: plastics contained toxics and caused world-wide litter, industrially processed food turned out to be a threat to public health, information and communication technologies provided a wealth of information but also threatened democratic society, and military technologies to secure freedom threatened humanity's very existence.

In reaction, there was a tendency to return to natural products and production processes. 'Industry' and 'Modern Technology' became suspect. Slogans emerged that emphasized the value of nature: 'Nature knows better' emphasizing healthier products without synthetic chemicals and "Nature does not produce any waste" criticizing the whole industrial society. Many of these slogans are in fact not verifiable empirical statements, and some of them are erroneous. Hence, 'natural' and 'nature derived' products and production processes are not a priori to be preferred above man-made products as the sustainable solution. Why are man-made products and processes not considered to be natural like the ones made by other animals? The first question that this paper addresses is how to assess 'natural'-, 'nature derived'- and 'classic' solutions to design challenges. In the first part of the paper, it is shown by various short case studies that design solutions from nature have survived long periods of selection pressure, which implies that they are in balance with their natural environment.

The vast number of specific niches that ecosystems provide has created an abundance of natural design solutions. Hence, in the second part, the question will be addressed if the study of 'natural principles' can help industrial designers to think outside the box.

Understanding biological analogies remains difficult for design students. Preliminary empirical research showed students using these, intentionally or unintentionally, copied aspects which are often misinterpreted into their design, i.e. blindly copying form while leaving out process or system. Biomimicry education offers new and compelling insights to measure and evaluate products, aiming to improve the sustainability score. This study reviews basic steps on how biomimicry could improve design education.

Keywords: Biomimicry, Natural Principles, Technology Assessment, Technological Hazards, BioBrainstorm, Distant Analogies, Design Thinking, Design Education

1. Introduction

1.1. Technology and its impacts

The emergence of the industrial- and the post-industrial information society has often been criticized for all its (often undesired and unforeseen) (side-) effects. Historically, the first worries about the impacts of human activities led to the conservationists' movement which aimed at protecting endangered species and created the first natural parks such as Yellowstone Park in 1872. Preservationists went one step further; they claimed that not only species were endangered, but nature itself [1].

In more recent history, especially the criticism of Rachel Carson created a watershed; Carson showed that human activities not only threatened species, ecosystems, and even nature, but also the human society itself. Carson showed that technology not necessarily created 'progress' for society, but could in fact have more hazardous impacts for society than positive contributions. Especially chemicals were the focus of her criticism [2].

In reaction to Carson's criticism, there was a tendency for more natural materials: wool, cotton and linen terminated the advance of synthetic textiles[3, 4, p. 226]. The use of agro-chemical was quantitatively and qualitatively reduced. Natural solutions were considered better. The argument was often based on quality: synthetic materials were often highly flammable, lost their colours rapidly, and were sometimes irritating the skin. Agro-chemicals were criticized for leaving harmful residues at agricultural products and for the harms they caused for the land and the workers. Natural solutions were introduced in agriculture as an improved form of crop protection, and in textiles as better quality.

By aiming at original and innovative solutions, product designs might easily have flaws that do not show: e.g. a material of a design might not be toxic, but its colour, texture, shape, smell, or X might influence species in a devastating way. For example, anti-fouling agents (preventing growth of organisms on ship hulls) that were designed to be least toxic for the environment, turned out to stop invertebrates from replicating, thereby threatening a complete ecosystem. Moreover they were accumulating in the food chain [5]. Half a century after CFCs were designed to make refrigerators safer in regard to fires and toxic emissions, they turned out to create a world-wide disaster by breaking down the ozone layer[6]. The history of DDT[2], Thalidomide[7], breast implants and many other products provide additional examples of the introduction of disastrous products. These problems not only occurred in the chemical sector: Despite reassuring messages from scientists, nuclear reactors turned out to be no virtually infallible designs [8, 9]. Various failed designs have been extensively described in the media [10, 11].

Technological failures (i.e. failures of a technology to produce desired impacts while not producing unexpected, undesired impacts) have occurred regularly. A technology might still be commercially successful while being a societal failure. This applies for example to technologies such as addictive drugs and unsafe or polluting products. However, at the societal level failed products could imply a tremendous loss. It took for instance 30 years to replace CFCs worldwide. The costs were initially estimated at 3 billion US\$[12]. Moreover, the ozone hole, caused by CFCs caused additional cases of skin cancer and harmed ecosystems especially in the Southern hemisphere.

Often mankind put too much trust in its man-made solutions, and neglected (or not even cared about) the undesired impacts that its products and processes had. This point was recognized in the 1960's: it was the

start of Technology Assessment (TA) as a method to assess all of the impacts (whether beneficial or detrimental) of new technologies. The ambition of TA was a scientific one: to assess new technologies factual and objective. However, soon after the first TA studies had been carried out, it became apparent that such a claim for completeness cannot be justified, as new unexpected impacts of products and processes might always be identified. Moreover, stakeholders will evaluate the impacts of new technologies by different standards [13]. Hence, it is impossible to provide a scientific assessment of the merits of a new product or processes.

1.2 Design and uncertain impacts

The impacts of new technologies and their assessment cannot be established with certainty. However, the impacts of new technologies can be disastrous[7, 9, 11]. Extensive testing procedures have been developed to test the risk of various products and processes. However, despite these tests, new products might be introduced that cause undesired, or even disastrous impacts. This holds especially for long term and indirect impacts.

Technological principles that are present in living organisms, or in artefacts that these organisms use, have been tested for extremely long periods. If these principles would have had major (indirect) negative impacts on these organisms themselves, this would have shown. For instance: Too successful predators will eventually have killed all their prey, which will make them starve, and animals adapting to a very specific climate might be prevented to migrate in times of local food scarcity. Mankind can learn from nature how organisms develop a 'fit' with their environment, not just a 'fit' with the direct properties of their environment, but especially also a fit with the dynamic properties of that environment, and the (indirect) changes that an organism caused itself in that environment. Hence, nature selects species by being in balance with their environment, not just a static balance but a dynamic balance that secures survival during changing conditions. Such dynamics can even be mathematically described. by the Lotka-Volterra equations [14].

Therefore, in designing systems, products and processes, designers should prefer to follow the example of natural equivalents of the function that they need: these equivalents have adapted and survived a long-term selection pressure.

1.3 limits to biomimicry?

However, are there equivalents in nature for whatever function designers might need? Well probably not. For example,

1. nature has no equivalent to the high tenacity, moldability and high melting point of metals.
2. Nature has no treatment for bone fractures. Mammals with serious fractures generally die.
3. Nature has no highly efficient solution for overland transport of goods: 'wheeled' transport is more efficient than 'legged' transport.

-1. A first argument might be that nature does not need them, but such an argument would be tough to prove as needs do not express themselves. Nature produces strength e.g. glass sponges make intricate latticed glass structures at ambient temperatures[15] and Golden Orb Weaver Spiders make silk threads many times stronger than man-made metals [16]. But the answer might also be in the extreme conditions to produce metals: many common metals can only be formed at such high temperatures that no species can survive them.

-2. Individual fractures, like diseases might strengthen a species, as they act as an evolutionary sieve. This might contribute to the long-term success of a species; at the expense of many of its individuals. Hence evolutionary success might be at odds with medical treatment of individuals. This touches a deep root of human civilisation, i.e. caring for the underprivileged.

-3. Wheeled transport is an efficient way of land transport, but wheels are not of much use in a rough landscape, or in a landscape with steep hills. A more or less horizontal and hard surface is required. Therefore, wheeled solutions require not only a carriage with wheels, but also a ‘road’, which implies that it requires ‘social organisation’ in order to create and maintain both roads and carriages. Moreover, a wheel always contains two separate parts, a disk and an axle, which cannot grow from the same life form. However, nature more or less approached wheels and roads: some insects developed ‘rolling’ for transport, and ants create roads. So, perhaps nature might reach similar solutions to wheeled transport in future evolution.

Would mankind have been happier without any metals, surgery and wheels? It is not our aim to answer such a question but to show that nature might inspire designers to better understand the function of their design, and to generate more alternatives leading to designs that better fulfil needs.

2. Learning from Nature

For as long as humans have existed, we have looked to nature for inspiration to solve our challenges. This idea of emulating from nature was revived by Janine Benyus in 1997. Her book, *Biomimicry, Innovation Inspired by Nature* describes how we can look to nature, not to extract from nature, but to learn from its design principles and overarching patterns, all of which have survived years of (re-)production and testing [17]. Since 1997, the field of biomimicry has expanded to inform, educate, and share its knowledge through websites and education [18]. A design can mimic an organism using form, process or systems. The basic level, or use of form is characterized by having the physical structure like the organism it was inspired by. The use of process is characterized by mimicking behaviour of an organism and mimicking an ecosystem in design (the highest level) mimics multiple functions and relationships [19]. It is here that we can learn how to ‘fit’ ourselves and how to solve design challenges within the same operating conditions.

2.1. Biomimicry Emulation

The laws of science apply in living organisms as well as in man-made artefacts. Hence, we might learn by what principles organisms develop symbiotic relationships with their environment: they should protect themselves from this environment, but also take everything they need from that environment. In doing so, their own properties/behaviour should not have a detrimental indirect impact. In fact, this is exactly what we want for sustainable designs.

Learning might also take place at another level: organisms are in part systems that have metabolic-movement-, information processing-, sensory- and control systems. The efficiency of these systems, and their symbiosis is an important determinant for the abilities of an organism. Man-made systems are often ordered like natural systems.

When mimicking nature in design solutions, we think that three issues at stake here are relevant to discuss in this paper:

1. Emulating from life (organisms and their interactions) itself;
2. Emulating from artefacts that the organisms make;
3. Emulating the creative process of new transformational learning.

2.2. Emulating Life

Biomimicry practitioners, those who practice biomimicry, first look at the scope of a challenge and ask, ‘what does the design need to do?’ In doing so, they are describing the need by its function. Subsequently, they take this function and look to another context, that of nature, and investigate how nature would solve this need. The process of looking at one context (e.g. biology) and applying characteristics of this to the second context (e.g. design) is called Analogical Thinking [20]. Each solution would then be a form, process or system analogy or a combination of these with form being the lowest level and systems being the highest. One might visualize analogies in examples such as Sharklet anti-fouling surface texture that mimics the micro-pattern form of shark skin [21] or such as the behaviour of how blue mussels create a glue that can function under wet conditions and is mimicked in life-friendly and non-toxic plywood [22] or to indicate a systems analogy, the multitude of connections and relationships of mycelium and the internet. One insight is that being able to remember the ABC’s of biomimicry, overarching patterns in life called Life’s Principles, may aid in this higher level of transfer.

Life’s Principles (figure 1) are regarded as the design lessons from nature, as aspirational goals and as sustainable benchmarks [19]. A well-adapted biological strategy must meet the functional needs of the organism in the context in which it lives in order to contribute to its survival. These 26 interconnected patterns from the same natural world flow into our design space because they are shared by the species that survive Earth today and thus, when integrated into a design, will also most likely facilitate and aid in the survival of the design. Practitioners use the principles to check and measure if the design has the same fit to pass the sustainability test and to check for missing limits and opportunities [23]. An example of a Life’s Principle in a design might be that of using modular and nested components or using readily available material and energy (such as using nearby materials or utilizing sunlight and wind to power the designs’ energy needs – or even the design process itself).

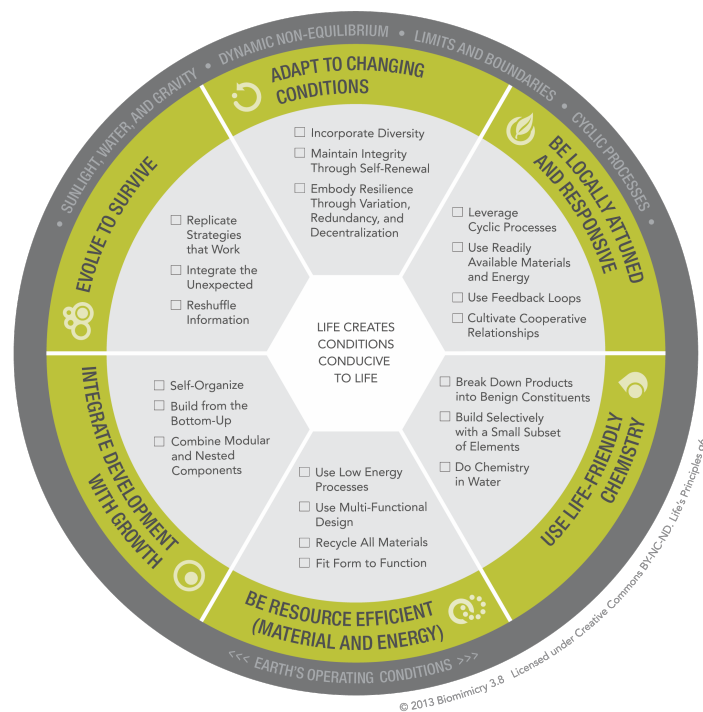

Figure 1: Biomimicry 3.8 Design Lens Life’s Principles (permission granted to reprint in research)

2.3. Artefacts Design by Nature

Many organisms use tools or nearby materials to produce artefacts. Often these artefacts are shelter and to protect the organism from abiotic or other biotic factors. A hummingbird nest for example, is made from twigs and leaves, and from spider web silk that the hummingbird has gathered (eaten) and used as a flexible adhesive. The nest is thus flexible and can stretch while the chicks grow to accommodate their rapid growth [24]. Termites build huge mounds with a constant temperature on the inside of around 30.5°C even when the exterior temperature is lower than 1.6°C or exceeds 40°C. Both are shelters of different sizes, and are interesting lessons for architects to emulate this building form, process and system. The Eastgate Building in Zimbabwe is one such example. By mimicking the termite mounds, the architect Mick Pierce could maintain the stable internal climate and save millions of dollars on costs for air conditioning and maintenance [25] by mimicking the interior airflow channels of the termite mounds.

2.4. Emulating Nature in Education

Biomimicry education brings nature into the classroom, creating a flow structure like nature does while raising awareness for sustainability concerns and giving students tools to do something about it [26]. The Challenge to Biology Design process pictured in figure 2 visualizes the full design circle which continues to repeat the phases through iterated cycles much like nature would do.

Ethos, or the ethical choices we make during design, as well as the reconnection to nature, are just as important as the emulation of natural strategies and mechanisms into design. Are our choices based on what nature would do and have we asked the question, ‘what wouldn’t nature do?’

The Big 5 of Education as stated by Naturalis Biodiversity Center in Leiden, the Netherlands, state that education should:

- Be awe inspiring
- Include real challenges
- Include relevant challenges
- Require scientific research and
- Cultivate inquisitiveness

Student survey responses have proven that all five requirements are included in biomimicry courses and challenges [26]. The scientific facts learned by the students opened their eyes to the multitude of breath-taking possibilities that were available when one simply looked to nature for solutions during the discovering phase. The challenges used in these design courses are real global issues geared towards solving some of the United Nations Sustainable Development Goals (SDG’s). The challenges themselves thus also increased their knowledge of global climate and environmental issues. The most difficult part of Biomimicry Design Thinking (figure 2) is abstracting and translating what is happening in the biology into engineering principles the designer can integrate into the design. Once the design function need is known, relevant organisms who solve this function already are scientifically examined through research articles explaining how the function is carried out. Life’s Principles guide the designer throughout the design process, creating ideas based on the visualization and description of those found strategies and mechanisms. Finally, these ideas are put to the test in a Life’s Principle evaluation.

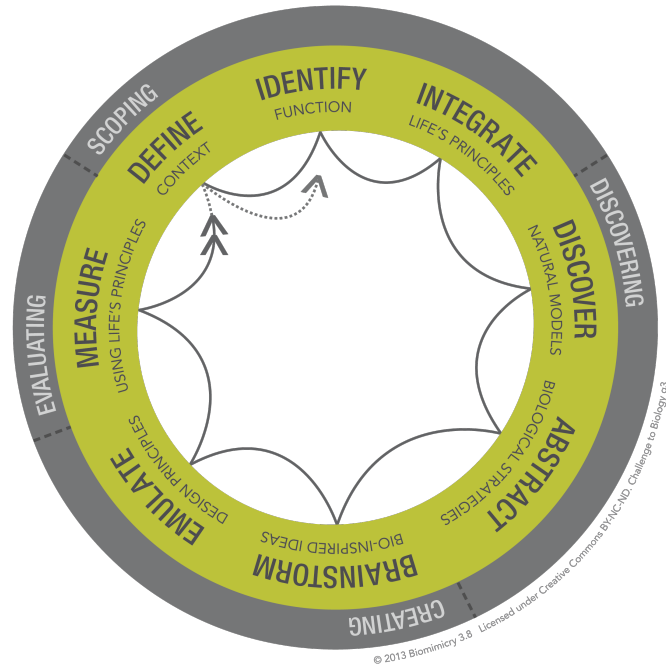

Figure 2: Biomimicry 3.8 Design Lens Challenge to Biology (permission granted to reprint in research)

3. Conclusion

Biomimicry education is motivating and inspires designers to look at the world around them to learn how nature has been solving the same issues for ages. If the question if everything can be designed by biomimicry is answered negatively, the question being asked for a design solution might not be the correct one. For example, humans have been successful in separating related entities: wheels and road surface, hard- and software, power generation and power consumption. Such divides do not occur in nature. The question we must ask in this case is, ‘How would Nature move or distribute?’ and consequently look to what the tested options are. By adjusting our design viewpoint to how nature would distribute locally or use readily available materials and energy for example, we can start to design for a future where humans have discovered how to survive as shareholder.

When the correct question is asked, every human challenge can be investigated through the field of biomimicry. Not only are the organisms in nature models for our designs when practicing biomimicry, but also the artefacts made by the organisms as well as the education leading us through the design phases. All are responsible for helping students to design better products regarding the environment in which the product must operate.

By not only testing our designs to the principles regarding the overarching patterns of life, but also by putting biomimicry education methodology to the same test, this sustainable education is placed into the same situations as life itself must follow to survive.

In conclusion, while biomimicry is an upcoming field and hundreds of practitioners graduate each year, education in the methodology needs visibility. It has been proven to cultivate curiosity in students, to inspire creativity and to offer yet unknown options at the design table. We have discovered that asking the correct question when deciding on a design approach is essential to move beyond what already exists and to investigate scientifically new ways of looking at a design challenge. When this open view is used, students thrive and want to learn and discover more, creating the educational atmosphere teachers thrive on[26].

References

1. Miller, C., *Gifford Pinchot and the making of modern environmentalism*. 2013: Island Press.
2. Carson, R., *Silent spring*. 1962, London: Hamish Hamilton.
3. Mulder, K.F., *Replacing nature, the arising of polymer science and synthetic fiber technology. The interaction between technology and science.*, in *Studies in Technology and Science*, B. Gremmen, Editor. 1991, LU Wageningen.: Wageningen. p. 239-262.
4. Ndiaye, P.A., *Nylon and Bombs: DuPont and the March of Modern America*. 2007: JHU Press.
5. Antizar-Ladislao, B., *Environmental levels, toxicity and human exposure to tributyltin (TBT)-contaminated marine environment. A review*. *Environment International*, 2008. **34**(2): p. 292-308.
6. Mulder, K.F., *Innovation by disaster: the ozone catastrophe as experiment of forced innovation*. *International journal of environment and sustainable development*, 2005. **4**(1): p. 88-103.
7. Botting, J., *The history of thalidomide*. *Drug news & perspectives*, 2002. **15**(9): p. 604-611.
8. Gamson, W.A. and A. Modigliani, *Media Discourse and Public Opinion on Nuclear Power: A Constructionist Approach*. *American Journal of Sociology*, 1989. **95**(1): p. 1-37.
9. Perrow, C., *Normal accidents: Living with high risk technologies-Updated edition*. 2011: Princeton university press.
10. Baudet, E.H.P., *Een vertrouwde wereld: 100 jaar innovatie in Nederland*. 1986: B. Bakker.
11. Veldhoen, L. and J. van den Ende, *Technische mislukkingen: de Planta-affaire, instortende bruggen, vliegdekschepen van ijs*. 1995: Donker.
12. Browne, M., *Grappling With the Cost Of Saving Earth's Ozone*, in *New York Times*. 1990: New York.
13. Van Eijndhoven, J.C., *Technology assessment: Product or process?* *Technological Forecasting and Social Change*, 1997. **54**(2): p. 269-286.
14. Lotka, A.J., *Elements of physical biology*. *Science Progress in the Twentieth Century (1919-1933)*, 1926. **21**(82): p. 341-343.
15. Kulchin, Y.N., et al., *Optical fibres based on natural biological minerals—sea sponge spicules*. *Quantum Electronics*, 2008. **38**(1): p. 51.
16. Lewis, R., *Unraveling the weave of spider silk*. *Bioscience*, 1996. **46**(9): p. 636-638.
17. Benyus, J.M., *Biomimicry: Innovation inspired by nature*. 1997, Morrow New York.
18. University, A.S. *Master of Science (MS) in Biomimicry – Online*. 2020; Available from: <http://biomimicry.asu.edu/education/asu-online-masters-degree/>.
19. Baumeister, D., et al., *Biomimicry resource handbook*. A seed, 2012.
20. Casakin, H. and G. Goldschmidt, *Expertise and the use of visual analogy: implications for design education*. *Design studies*, 1999. **20**(2): p. 153-175.
21. Sharklet technologies, i. *Cision PR Newswire*. 2019 25 January, 2020]; Available from: <https://www.prnewswire.com/news-releases/sharklet-a-biomimetic-antibacterial-and-antifouling-technology-launched-at-the-old-man-and-the-sea-a-sneak-peek-into-the-future-300969768.html>.
22. AskNature. *Terrapin bright green*. 2016 25 January, 2020]; Available from: <https://asknature.org/resource/purebond-technology-wood-glue-without-formaldehyde/>.
23. University, A.S., *Course lecture Essentials of Biomimicry*. . 2016, Arizona State University. sedona., T.h.s. *Hummingbird Predators*. . 2020 3 February, 2020,]; Available from: <https://www.hummingbirdsociety.org/predators/>.
25. Inhabitat. *BIOMIMETIC ARCHITECTURE: Green Building in Zimbabwe Modeled After Termite Mounds*. . 2012 3 February, 2020]; Available from: <https://inhabitat.com/building-modelled-on-termites-eastgate-centre-in-zimbabwe/>.
26. Stevens, L., et al. *Biomimicry Design Education Essentials*. in *Proceedings of the Design Society: International Conference on Engineering Design*. 2019. Cambridge University Press.

Guidelines to improve Engineering Education for Sustainability through transdisciplinarity learning processes

Gemma Tejedor¹, Jordi Segalas¹

¹University Research Institute for Sustainability Science and Technology, Universitat Politècnica de Catalunya. BarcelonaTech, Catalonia, Spain

gemma.tejedor@upc.edu

Abstract

Actions for sustainability are promoted from the different areas of environment, society, technology and economy, with the common aspiration to face interconnected crises in a world that can no longer be conceived as “society without nature and nature without society”. From this imperative for the integration of epistemics, university is called to restructuring boundaries and processes to properly serve society. Given that engineering principles are aligned with that logic, it is argued that engineering education (EE) have to evolve to being engineering-problem oriented and further developed into socio-technically oriented.

Transdisciplinarity emerged in this context pursuing integration of academic and practical or traditional knowledge outside the academia, to co-produce outcomes both socially robust and transferable, that is, useful for transitioning and scientifically innovative to formulate new guiding principles.

In order to improve engineering education in sustainability (EESD) through transdisciplinary learning approaches, we performed a three phases research. Firstly, we analysed how sustainability was approached in EE, through a co-word analysis and characterization of the keywords' networks of three relevant journals in the EESD field. The journal networks evolution analysis suggested that social concern in engineering is growing . The keywords characterisation showed relevant categories being related to transdisciplinary education strategies for applying sustainability and to cross-boundary schemes. Finally, a modularity analysis showed that keywords related to transdisciplinarity spread throughout all the areas of knowledge addressed by the journals, indicating a widening interest.

The second phase studied how emergent EESD initiatives were approached from transdisciplinarity discourses. Most of them fitted in the problem-solving discourse, where co-production of knowledge and method-driven aspects are also relevant. Deepening this discourse, most initiatives corresponded to the real-world argument promoting science-society collaboration in societal problems (EU contexts); others looked for convergence of sciences in pursuit of human well-being (innovation argument, US contexts); and some initiatives brought together students and entities in a team-based learning process with social purpose (transcendent interdisciplinary research- TIR argument). None of the initiatives fitted the transgression discourse, attempting to reformulate the establishment, no longer for society but with society.

The last phase consisted in the implementation of a transdisciplinary learning environment experience in a 5 ETCS course of the UPC Master degree in Sustainability Science and Technology. Civil organisations, students and educators undertook collaborative research on real-life sustainability case studies, following two cycles of action-reflection. While the course mainly fitted in the real-world argument of problem solving, service learning and CampusLab schemes also reproduced team-based learning with societal purpose (TIR argument). The transgression discourse was addressed through service learning focusing on

social justice. Some students engaged further as professional researchers-activists. Additionally, a well-valued Emotional Intelligence module was developed to help students face some process paralyzing uncertainties.

From the lessons learned, we proposed a set of fundamental features to be considered for an effective scheme for a transdisciplinary approach in EESD, methodically framing the science-society discourse on the issue at stake: work in real-world complex problems; involve diverse disciplines and fields cooperation; involve science-society cooperation and mutual learning processes; integrate types of knowledge; rely on disciplinary and cross-disciplinary practices.

1 Introduction

Since sustainability science appeared in the university arena in the early 1990s, academic faculty have agreed that dealing with the complex problems faced by human society and the natural environment requires a transdisciplinary approach both in research and in sustainability education, and that universities should focus on developing capacity for transdisciplinarity (Jantsch, 1972; Russell, et al. 2008; Ertas et al., 2003).

The research presented in this article aims to improve engineering education in sustainability (EESD) through transdisciplinarity (td) learning approaches. The research comprised three phases, consisting of looking first at the principal approaches to sustainability in engineering education (EE), being td identified as one of them, then examining different experiences in engineering education for sustainability with a td perspective and finally, piloting a td learning experience in a technological university.

Going through the different phases some elements and factors that repeatedly appear to be relevant to perform a td approach were identified. Consequently, a set of fundamental features to be considered for an effective scheme for a td learning approach are proposed as guidelines, which significantly may facilitate any educational initiative in EESD to undertake a transdisciplinary learning scheme.

2 Research phases

2.1 *Patterns and trends in Engineering Education in Sustainability: a vision from relevant journals in the field*

The first phase consisted of the analysis of how sustainability is approached in EE through a co-word analysis and characterization of the keyword's networks of three relevant journals in the field of EESD over two decades. We applied a bibliometric approach, adopting a co-word analysis based on co-occurrence of keywords (300) in articles (171) from three indexed journals related to the terms engineering, education or sustainability, previously identified in a structured way, based on the appearance of two of the previous three terms in the journal scope (based on Journal Citation Reports) and the last term in the journal topic and title fields.

Further, the network of keywords was structurally and temporally analysed, and the keywords categorized to identify topological patterns and their evolution. The categorization¹ raised two main blocks in terms of

¹ Nine categories were identified (see article, section 2.3, Table 3), namely: Institutional and policies; Curricular structure; Educational strategy; Competences/behavioural aspects; Academic/professional development; Sustainability Pillars topics: techno-environmental; Sustainability Pillars topics: techno-economics; Sustainability Pillars topics: socio-cultural; Contents referring to social and cultural issues; Transdisciplinarity and collaborative networking

corresponding number of keywords: a) relevant categories but decreasing at the end of the period, related to institutional and policy aspects of embedding sustainability in higher education; b) relevance increasing categories related to the professional development of faculty members, implementation and use of learning strategies (real-world learning experiences, educational innovation) and cross-boundary schemes (transdisciplinarity, ethics, networking), suggesting that the concern was growing to move to society.

The analysis of the structural network evolution based on the keywords co-occurrence, highlighted considerations at two levels: the individualised journal networks and the global network. Regarding the connectivity between the different areas in which research was done for each journal, it is suggested that JCLP presents the higher (globular shape), i.e. the same keywords being used in different articles; IJEE the lower (linear shape), suggesting research made in separate areas, where articles use different keywords from one another; and IJSHE is in between.

The rest of network metrics gave some insight on the networks' evolutionary behaviour and research trends, namely a) three areas constantly dropped along the studied period, related to transdisciplinarity, techno-environmental topics and academic professional development, especially in IJSHE and JCLP; b) IJSHE had a will of reinforcing relationships beyond the university, while IJEE gave relevance to real North-South case studies; and JCLP contributed aspects on competences and educational strategies (Tejedor et al., 2019)

2.2 Transdisciplinarity in higher education for sustainability: How discourses are approached in engineering education

The second phase of the research studied how emergent EESD initiatives were approached from td, as valued competence for sustainability. The initiatives identified were clustered according to the characterization proposed by Julie Thompson Klein's (2014) analysis of one decade of contributions in td (2004 to 2014). Klein identified three recurrent "discourses on transdisciplinarity", namely transcendence, problem solving (which encompass different argumentations, namely real-world argument, innovation argument, transcendent interdisciplinary research argument and the argument of the university framed by purpose) and transgression, which help to understand the evolution and different trends of the td thinking.

An initial literature review showed diverse emergent modalities of learning environments at the technological universities, where a td approach was introduced, from courses in undergraduate programs to workshops in postgraduate levels, often led by committed lone professors aiming to engage with the macro ethical and cross-disciplinary sustainability challenges. To generate an overview, the authors matched the identified initiatives to the discourses on transdisciplinarity. An affinity analysis was performed to validate the first qualitative analysis, grouping the initiatives in homogeneous groups, and showing experimentally what rationality informs: that authors in a group share similar thoughts. Furthermore, the affinity analysis provided a good starting point to identify the discourses on transdisciplinarity, validating the classification proposed.

The research indicated that most of the initiatives fitted in the problem-solving discourse, where co-production of knowledge and method-driven aspects are relevant. Deepening this discourse, most initiatives corresponded to the real-world argument promoting science-society collaboration to solve societal problems (EU contexts); others looked for convergence of all sciences (life, human, physical and engineering) in pursuit of human well-being (innovation argument, US contexts); and some initiatives brought together students and entities in a team-based learning process with social purpose (transcendent interdisciplinary research "tir" argument).

Besides, a few experiences represented the discourse of transcendence. This discourse is related to the need of a synthetic connotation for the production of knowledge within science, known as Mode 1 td (Gibbons et al., 1994). At the individual sphere, the discourse suggest the need of professionals with a transdisciplinary attitude, who “mediates to the result of making sense together” (Klein, 2004). It is noteworthy that none of the initiatives mirrored the transgression discourse, which attempts to reformulate the establishment, no longer for society but with society (Tejedor et al., 2018).

2.3 Action research workshop for transdisciplinary sustainability science

With the aim of piloting our findings, a transdisciplinary learning environment experience was designed and piloted: the course Action Research Workshop on Science and Technology for Sustainability (5 ETCS) of the UPC Master degree in Sustainability Science and Technology, where civil organisations, public administration, students and educators undertook collaborative research on real-life sustainability case studies, following two cycles of action-reflection. Case studies came both from external entities or NGOs and the UPC campus.

When looking at the discourses of td, we realized that while the course mainly fitted in the real-world argument of problem solving, educational strategies like service learning or Campus Lab schemes, which were used related to different case studies, should reproduced a team-based learning with societal purpose (transcendent interdisciplinary research argument). Moreover, some of the Campus Lab case studies aligned with the transdisciplinarity framed by purpose argument since universities as living labs can provide a potential holistic and iterative framework for the co-production of knowledge from the different university systems (Evans et al., 2015).

In order to integrate the discourse of transgression, which relies on an attitudinal attempt of criticism and reformulation of reality, a service learning scheme was used, focusing on social justice, which enhanced the development of complex thinking to achieve social transformation through education (Aramburuzabala, 2013), going beyond observing and analysing societal transformations, but rather taking an active role in initiating and catalysing change processes (Schneidewind et al., 2016). Some of the students continued their final master thesis in the fields, and even some of them engaged as employee-activists at the NGO they were working with. The workshop coordinators’ role may fluctuate between facilitators and sometimes catalysts in a way, going beyond observing and analysing societal transformations.

Challenges of their learning process were problem formulation which proved to be one of the most arduous tasks, process uncertainty, stakeholder’s interests and roles integration, and interpersonal skills. Students appreciated the td approaches and mixed research methods, the reflection stages with interesting work and discussion sessions, and the possibility to work in real-life projects with real stakeholders, despite regarding challenging both the integration of different interests and perspectives in the problem approach as well as the recognition of stakeholders’ roles during the process. Additionally, a well-valued Emotional Intelligence module was developed by the author to help students face some process paralyzing uncertainties (Tejedor et al., 2019b)

3 Guidelines to implement a td approach

Transdisciplinarity was initially envisioned in the OCDE conference in 1970 as a set of axioms to be shared by the different disciplines, evolving to be considered that “transdisciplinary knowledge develops its own distinct theoretical structures” (Gibbons et al.,1994: 5). Td further adopted a popular pragmatic approach

at the 2000 Zurich conference, shifting from theory-science deliberations to wondering what it was for in practice (Russell et al. 2008; Klein, 2008). This shift emphasized the need for bringing internal reflexivity into any process of td knowledge production, as a drive, a claim and even “an attitude and a form of action” (Klein, 2004: 521). Anyway, regardless of the accuracy of defining td, a plurality of understandings of it have been started to be recognized, considered depending on specific thematic and socio-cultural contexts (Klein, 2014; Huutoniemi et al., 2010; Bunders et al., 2010). This plurality exploration interest is aligned with the core values and the transdisciplinary principle of “open encounter” (Pohl et al., 2010).

From the Zurich 2000 inflection point the common ground between the different currents of td are their emphasis on the integration of knowledge and the multidimensionality type of reasoning for the articulation of different realities, while differing in their specific characteristics of the role of science in society. Engagement with society is not central in the US American connotation of td (linked to health social system) but it is considered the receptor of innovation from the integration of theories, concepts and methods that “transgresses or transcends” disciplines (Stokols, 2006; Miller et al. 2008). The German and EU connotation (linked to socio-environment systems) instead emphasizes that the participation of social actors is pivotal (Muhar et al., 2013; Pohl et al. 2010; Scholz et al., 2006).

The former considerations reinforces the idea of td as an approach, not a theory or methodology (Scholz & Steiner, 2015; Jahn et al., 2012), even though it can be method-driven, specially within the problem-solving scope (Lang et al., 2012; Scholz et al., 2006; Steiner & Posch, 2006). Specifically, engineering and technology education enter familiar grounds in the discourse of real-world problem solving (more related to the EU-German connotation), characterized by a high level of methodological aspects. This shift emphasized the need for bringing internal reflexivity into any process of td knowledge production, being at the same time a drive, a claim and even "simultaneously an attitude and a form of action".

Along the research phases some relevant elements and factors to perform a td approach were identified. Taking into account the recognition of td as a drive or a claim for internal reflexivity in any td process (Klein, 2004), a set of fundamental features are proposed to be considered as guidelines allowing to methodically framing the science-society discourse about the issue at stake, which significantly may facilitate any educational initiative in EESD to undertake a transdisciplinary learning scheme (Table 1).

Table 1: Guidelines for Transdisciplinary learning in EESD.

Key features	Description
<i>To work in complex problems originated in real-world contexts</i>	The complexity of a real-world problem requires moving beyond scientific expertise, even within such an extended peer community setting or an agora of public deliberation. Any educational engineering experience has to facilitate setting the environment and society in the center, to make them the ultimate goal of technological implementation.
<i>To involve cooperation between various</i>	Different disciplinary perspectives must be included to reach a common ground. Transdisciplinary (td) forms of knowledge should complement, not substitute, disciplinary knowledge, connecting what has been disconnected by the ongoing specification and fragmentation of knowledge production in the disciplinary structure. This implies different disciplines working together without leaving

<i>disciplines and fields</i>	their theoretical and methodological disciplinary framework but adapting common problem formulation and solutions management to specific situation.
<i>To involve cooperation between science and society</i>	<p>Cooperation between researchers and ‘practitioners’ has to be established both in the way of approaching problems and in the recognition of non-scientific knowledge as equally valuable, enabling conceptual and methodological shared frameworks. Some kind of contract or previous agreement should be defined to establish relationship guidelines.</p> <p>Transdisciplinarity is more than a research approach that is better suited to cope with the complex problems that scientific progress itself continuously creates. Rather, it indeed addresses the relation between science and society. It is interventionist in the sense that it methodically frames, structures, and organizes the societal discourse about the issue at stake.</p>
<i>To enable processes of mutual learning between science and society</i>	<p>The learning experience has to enable processes of exchange, joint generation and integration of existing or new knowledge. The idea behind it is to catalyze achievements by both stakeholders and students, on equal footing, i.e. accepting the otherness, co-leadership and the different interests, epistemics and roles.</p> <p>For this purpose, co-creation processes may facilitate the matching of contributions, interests and needs. One of the key prerequisites for initiating a successful td process is to negotiate and define a proper goal or guiding question; the process in itself of answering provides benefits to all participating stakeholder groups.</p>
<i>To integrate different types of knowledge</i>	<p>Integration has been largely emphasized as an essential cognitive challenge in the td process. Beyond building bridges between disparate disciplines, the need for communicating in an accessible way comes out. Integration, therefore, refers not only to what we know but to how we communicate.</p> <p>Knowledge integration and collaborative methods and tools may be experienced as pills or modules in a td-learning environment. The experience of this different way of knowledge creation surely transforms the perception of quality, competence and value of the different sources, including lay knowledge.</p>
<i>To rely both on disciplinary and cross-disciplinary practices</i>	<p>Transdisciplinary work is based on disciplinary practice as a rule. Yet, despite being distinct, they are complementary and can enrich each other and eventually reshape internal borders.</p> <p>Therefore, the learning experience should encompass disciplinary practice, as well as multi- interdisciplinary ways to approach technological problem solving. Not everyone has all the required experience, thus the working groups must be formed based on the areas of knowledge and expertise represented and the topics to be addressed.</p>

4 Conclusions

Starting with the identification of transdisciplinarity as a relevant approach to sustainability in engineering education (EE), this research analysed EESD initiatives that used a transdisciplinarity approach to

overcome the one-dimension classical training in technological problem solving (Scholz et al., 2006), closer to “applicability” than to “comprehension”, which often keeps engineers away from the source of the needs posed to them. In this sense, aligned with the lesson learned from the implementation of a transdisciplinary learning environment it is considered that when the formulation of life-world problems is independent of disciplinary perspectives, the inclusion of the societal context and experience in which they originated, enables providing more socially robust guidance.

Regarding the discourses on t analysis, EESD fits well in initiatives related to the discourse of problem solving, on the basis that a technological problem can include elements from all the different cross-disciplinary ways of approaching problems. The real-world argument, consisting on the co-production of knowledge to address societal problems, was seen mainly based on highly method-driven schemes, as can be action research, considered a precursor of transdisciplinarity. Parallely, a team-based learning scheme with a societal purpose (transcendent interdisciplinary research argument) can be addressed by means of service learning or team-based CampusLab schemes. Finally, we proposed addressing the transgression discourse in the field of engineering by means of service learning focusing on social justice, which enhances engagement of the students as professional researchers-activists in the participant organisations.

The adoption and development of a td approach in the Action Research Workshop was perceived useful to enhancing the understanding and enabling the learning of sustainability, where students also realized the high significance of taking the research to the community and collaborating with stakeholders.

Finally, a set of of fundamental features was proposed to be considered as guidelines allowing to methodically framing the science-society discourse about the issue at stake, to facilitate any educational initiative in EESD to undertake a transdisciplinary learning scheme.

References

- Aramburuzabala P (2013) Aprendizaje-Servicio: una herramienta para educar desde y para la justicia social. *Revista Internacional de Educación para la Justicia Social* 2(2), 5–11
- Bunders, Joske F.G., Jacqueline E.W. Broerse, Florian Keil, Christian Pohl, Roland W. Scholz, & Marjolein B.M. Zweekhorst. 2010. How Can Transdisciplinary Research Contribute to Knowledge Democracy? *Knowledge Democracy: Consequences for Science, Politics, and Media*, 1–397.
- Ertas, Atila, Timothy Maxwell, Vicki P. Rainey, & Murat M. Tanik. 2003. Transformation of Higher Education: The Transdisciplinary Approach in Engineering *IEEE Transactions on Education* 46, 289–95.
- Evans, Tina Lynn. 2015. Transdisciplinary Collaborations for Sustainability Education: Institutional and Intragroup Challenges and Opportunities. *Policy Futures in Education* 13 (1), 70–96.
- Gibbons, M., Limoges, C., Nowotny, H., Schwartzman, S., Scott, P., & Trow, M. (1994). *The new production of knowledge: The dynamics of science and research in contemporary societies*. Newbury Park, London: Sage.
- Huutoniemi, Katri, Julie Thompson Klein, Henrik Bruun, and Janne Hukkinen. 2010. Analyzing Interdisciplinarity: Typology and Indicators. *Research Policy* 39 (1), 79–88.
- Jahn, Thomas, Matthias Bergmann, and Florian Keil. 2012. Transdisciplinarity: Between Mainstreaming and Marginalization. *Ecological Economics* 79, 1–10.

- Jantsch, E., 1972. Interdisciplinary and transdisciplinary university. Systems approach to education and innovation. *Higher Education* **1** (1), 7-37.
- Klein, T., Julie. 2004. Prospects for Transdisciplinarity. *Futures* **36** (4), 515–26.
- Klein, T., Julie T. 2008. Evaluation of Interdisciplinary and Transdisciplinary Research: A Literature Review. *American Journal of Preventive Medicine* **35** (2 Suppl), 116-23.
- Klein, T., Julie. 2014. Discourses of Transdisciplinarity: Looking Back to the Future. *Futures* **63**, 68–74.
- Lang, Daniel J., Arnim Wiek, Matthias Bergmann, Michael Stauffacher, Pim Martens, Peter Moll, Mark Swilling, & Christopher J. Thomas. 2012. Transdisciplinary Research in Sustainability Science: Practice, Principles, and Challenges. *Sustainability Science* **7** (S1), 25–43.
- Miller, T. R., T. D. Baird, C. M. Littlefield, G. Kofinas, F. Chapin, III, & C. L. Redman. 2008. Epistemological pluralism: reorganizing interdisciplinary research. *Ecology and Society* **13**(2), 46.
- Muhar, Andreas, Jan Visser, & John van Breda. 2013. Experiences from Establishing Structured Inter- and Transdisciplinary Doctoral Programs in Sustainability: A Comparison of Two Cases in South Africa and Austria. *Journal of Cleaner Production* **61**, 122–29.
- Pohl, Christian, Pasqualina Perrig-chiello, Beat Butz, Gertrude Hirsch Hadorn, Dominique Joye, Michael Nentwich et al. 2010. Questions to Evaluate Inter- and Transdisciplinary Research Proposals. *Network for Transdisciplinary Research (Td-Net) of the Swiss Academies of Arts and Sciences, Bern* **41** (0), 23.
- Russell, A. Wendy, Fern Wickson, & Anna L. Carew. 2008. Transdisciplinarity: Context, Contradictions and Capacity. *Futures* **40** (5), 460–72.
- Schneidewind, Uwe, Mandy Singer-Brodowski, Karoline Augenstein, & Franziska Stelzer. 2016. *Pledge for a Transformative Science*. 191_Wuppertal Paper, 29.
- Scholz, Roland W., Daniel J. Lang, Arnim Wiek, Alexander I. Walter, & Michael Stauffacher. 2006. “Transdisciplinary Case Studies as a Means of Sustainability Learning: Historical Framework and Theory.” *International Journal of Sustainability in Higher Education* **7** (3), 226–51.
- Scholz, Roland W., & Gerald Steiner. 2015b. The Real Type and Ideal Type of Transdisciplinary Processes: Part II—What Constraints and Obstacles Do We Meet in Practice? *Sustainability Science* **10** (4), 653–71.
- Steiner, Gerald, & Alfred Posch. 2006. Higher Education for Sustainability by Means of Transdisciplinary Case Studies: An Innovative Approach for Solving Complex, Real-World Problems. *Journal of Cleaner Production* **14** (9–11), 877–90.
- Stokols, Daniel. 2006. Toward a Science of Transdisciplinary Action Research. *American Journal of Community Psychology* **38**, 63–77.
- Tejedor, G., M. Rosas-Casals, & J. Segalas. 2019. Patterns and Trends in Engineering Education in Sustainability. *International Journal of Sustainability in Higher Education*, **20** (2), 360-377.
- Tejedor, G., J. Segalas, & G. Cebrián. 2019b. Correction to: Action Research Workshop for Transdisciplinary Sustainability Science (*Sustainability Science*, (2018), **13** (2), 493–502).
- Tejedor, G., J. Segalàs, & M. Rosas-Casals. 2018. Transdisciplinarity in Higher Education for Sustainability: How Discourses Are Approached in Engineering Education. *Journal of Cleaner Production* **175**, 29-37.

Challenge Driven Education for sustainability in engineering. A White Paper

Gemma Tejedor¹, Anna-Karin Högfeldt², Jordi Segalas¹, Lena Gumaelius²

¹University Research Institute for Sustainability Science and Technology, Universitat Politècnica de Catalunya. BarcelonaTech, Catalonia, Spain
gemma.tejedor@upc.edu

²Department of Learning, KTH Royal Institute of Technology, Sweden

Abstract

Two contemporary academic movements can be argued to be important for the integration of more field-practice- and cross disciplinary team-based learning experiences into the engineering education curriculum. Firstly, the growth of research in sustainability challenges in combination with the need for change in engineering education, which is seen to evolve from environmental focus to the inclusion of social and transdisciplinary approaches. Secondly, the evolution of engineering education in general: from traditional and instructive to student centered, constructive and practice oriented as well as from isolated and exclusive to an inter-twined part of society, where society's need for "socially responsible future entrepreneurs, innovators and leaders".

This implies that all engineers need to be equipped with knowledge, skills, values and experiences in order to meet the needs of society.

Challenge driven education (CDE) is an evolving concept that can bridge engineering and sustainability. In the challenge driven education, students are working on real-life and often real-time challenges in society and industry. The students work with open-ended, ill-defined problems that do not have a single right answer. With the challenge driven education approach, the aim is to position ideas, innovations and decision making in the forefront of the learning process.

InnoEnergy is a transnational educational initiative supported by the European Institute of Innovation and Technology (EIT). From the investigation made on the integration of CDE in seven international and cross-border InnoEnergy Masters' programs, the need appeared for a common understanding on CDE within the knowledge innovation community. The investigation aimed to explore: the perceived drivers and barriers for CDE; the different approaches for integrating CDE in the seven masters' programs; and the perceived scope for CDE mapped to the achievement of competences for sustainability.

Preliminary findings showed that there was a common core of successful initiation of the integration of the CDE approach, although differently in the seven masters' programs, from different perceptions of CDE for sustainability within the community. Furthermore, the findings revealed a narrow view of sustainability, where the concept is implicitly integrated or "obviously" in some programs with a intend at finding more sustainable energy solutions.

An InnoEnergy CDE White Paper has been elaborated, setting the goal for the future progress of challenge driven InnoEnergy MSc education. The paper contributes the definition behind this concept and a strategy on the future development, as well as some best practices of the work so far. Furthermore, the overarching

learning outcomes for EIT programs and the UNESCO cross-cutting key competences needed for problem solving for sustainable development, have been merged as new expected outcomes, so that intended learning outcomes based on both perspectives are developed.

1 Introduction

An immediate transformation towards sustainable energy innovations is crucial for our future society. The mission of the Knowledge Innovation Community (KIC) InnoEnergy, consisting of universities, companies and research centers, is to be at the forefront of this development in Europe, through research, innovation and commercialization projects, and education and professional training.

Challenge-driven education (CDE) is a way to catalyse and ensure that education needed for this purpose will be implemented. The definition behind this concept will be explained, and a strategy for the future development will be presented as well as some best practices of the work so far.

Challenge-driven education is an excellent tool for teachers and students that are not only interested in the transmission of knowledge, but also on the development of skills and, going even further, in contributing personally in making possible a positive societal change. In Challenge-Driven education, students work on real-life and often real-time challenges in society and industry.

2 Challenge Driven Education in InnoEnergy

2.1 The motivation for Challenge-Driven education in InnoEnergy MSc programs

Professionals of engineering education step-by-step come to the agreement on the need to equip engineers with knowledge, skills, values and experiences in order to meet the needs of society (Cech, 2014; Declaration of Barcelona, 2004). The former epistemological structures are disrupted and consequently an “epistemic community” gain progressively understanding about new constructed knowledge (Knorr-Cetina 2007; Klein, 2008; Vilsmaier, 2015).

InnoEnergy is a transnational educational initiative, corresponding to one out of the nine knowledge innovation communities (KIC) supported by the European Institute of Innovation and Technology (EIT). The InnoEnergy consortium has the mission to educate professionals ready to take on the challenges of tomorrow (EIT, 2018), offering high standard Master of Science (MSc) programs in different universities, members of the European Higher Education Area (EHEA), which is monitored by the ministers of education in each EU member country.

In this context, European agendas for higher education have to be reflected in the InnoEnergy education programs, where the European Commission decided on “A renewed EU agenda for higher education” in 2017; the “Paris Communiqué”¹ provides a road map for the continued collaboration and progress towards the goals of the Bologna process; and the “Standards and Guidelines for Quality Assurance in European Higher Education Area”² regulated processes for quality assurance.

¹ The Paris Communiqué, was signed by the European Higher Education Area (EHEA) Ministers in Paris, on May 25th 2018. http://www.ehea.info/Upload/document/ministerial_declarations/EHEAParis2018_Communique_final_952771.pdf

² The “Standards and Guidelines for Quality Assurance in European Higher Education Area” were authored by the European Association for Quality Assurance in Higher Education, together with the European University Association (EUA), the European Students' Union (ESU) and the European Association of Institutions in Higher Education (EURASHE). <https://enqa.eu/index.php/home/esg/>

The requirement arises for a lifelong learning skills training, through a student-centered and cross-organizational education, where all institutional and disciplinary; physical and virtual; and research and teaching borders should be crossed.

In alignment, the EIT MSc programs emphasizes the integration of innovative learning-by-doing curriculum in the courses, also providing student mobility on a cross-organizational an international level. Their Overarching Learning Outcomes (OLOs) are aiming at competencies for sustainability, entrepreneurship, creativity, innovation, research, intellectual transformation as well as leadership and the assessment of students' learning aim to measure competence- and impact-based activities "in a real-life situation to create a change or solve a challenge" (EIT, 2018:19).

On the other hand, the Sustainable Development Goals (UNESCO, 2017) sets the goal for the UNESCO strategy for Education for sustainable development, where InnoEnergy as an innovation community within the EIT has an opportunity to step forward in innovative energy engineering education.

Within this framework the InnoEnergy program directors at each program undertake from 2015 the integration of CDE project-based courses in the MSc programs, in a valuable effort to introduce to the greatest extent, challenges that should be socio-technical and relate to the UN SDGs, especially the SDG7 "Sustainable energy", since it is the priority area for InnoEnergy. Involved faculty was committed in general to offer strong and motivating learning experiences. The interest for harmonize and go together making further progress to the implementation of Challenge-Driven approaches within the InnoEnergy MSc programs, leads to the elaboration of a White Paper on CDE in InnoEnergy, as a result of a two years research (2018-2019) research.

3 Methodology

3.1 First phase. State of the Challenge-Driven education in InnoEnergy MSc programs

In the first phase, the research team started out semi structured interviews with academic program directors and faculty running the project courses, were transcribed and analyzed, based on their CDE integration. Furthermore, a selection of the students' final reports was analyzed from three of the seven programs, SELECT, RENE and SENSE.

The results and conclusions of the work were validated at the InnoEnergy Teachers Conference (TC) (April 2018, Santa Cruz de Tenerife), where a Co-creative workshop was held. Around 40 teachers, program coordinators and InnoEnergy team members from the seven MSc discussed and reflected in a World Café format, upon four different themes based on the information collected, namely: Definition of CDE; CDE implementation; External stakeholders' roles; Link to SDGs.

3.2 Second phase. White Paper on Challenge-Driven education in InnoEnergy

Starting the second phase of the research, the conclusions of the TC resulted on the core of a proposal for developing a White Paper for Challenge Driven Education in the InnoEnergy community. At this point, in order to fully understand CDE in the InnoEnergy programs, it was necessary to collect the considerations of the different actors involved.

In order to explore the relation with stakeholders, the research team examined the InnoEnergy Master's School standardized annual evaluation survey, which is part of the Quality Assurance System (QAS), carried out among second year students, to monitor the quality indicators and take corrective actions when needed. The survey was also analyzed in term of the programs academic content taught at different universities, the relation with the InnoEnergy community and whether the Overall Learning Outcomes were

being adequately addressed, where those considered specifically relevant from the CDE perspective were picked out.

In order to get students' perspective, a focus group was conducted with group of students gathered at the year one in the SELECT MSc, where CDE had been largely implemented, and students asked whether they would like to be followed on a "long-term" basis. Students, both male and female, participated from different nationalities, backgrounds and ages.

Additionally, and with the aim to be aligned with the overall movement of European education, the InnoEnergy Program Directors panel decided the CDE research team to carry out a policy analysis on European, national and institutional level, with the aim to understand how policies and agendas for higher education reflected the ideals of CDE which is aimed to be submitted to a peer-reviewed journal.

Ending the year, on October 2019, two events took place in Brussels in relation to CDE. InnoEnergy was the organizer of the Cross-KIC Education Conference focused on CDE, with the aim of offering a communication platform for contributing ideas and learning and synergies along the different KICs. The CDE research team participated the design of a dynamic educational day (Pecha Kucha session, Fishbowl discussion, keynotes, etc.), aligned with the active format of challenge-based education.

Finally, the CDE research team organized the 2019 Teachers Conference (TC) to become a networking forum, with working spaces for discussion of common current themes and trends about the master programs, facilitating there the introduction of the UNESCO cross-cutting competences (UNESCO, 2017) for the accomplishment of the UN Sustainable Development Goals.

4 Results

4.1 Challenge-driven education as it is described by the InnoEnergy community

Challenge driven education (CDE) is an evolving concept, and one of many alternatives which can bridge engineering and sustainability, also aligned with the previously mentioned agendas for higher education (Högfeldt, 2019). The concept comes from several roots and foundations, as is the integration of practice and theory, with the aim to increase its usefulness and relevance in the engineering professional life (Magnell, 2019; Crawley et al., 2014). The emphasis is also in crossing borders between the university and the society to create more civic, multicultural and outreaching institutions capable to understand and be useful for the society (Högfeldt, 2018; Garibay, 2015).

The wide perspective of CDE is a driver for creating a positive societal change with different perspectives:

- Contributing to the sustainable development goals
- Contributing to societal challenges created in national, regional or city based ecosystems, as well as global
- Contributing to creating a positive socio-economic impact by means of the collaboration with industry, as stated by the EIT

In the CDE, students are working on real-life and often real-time challenges in society and industry, dealing with open-ended, ill-defined, complex, socio-technical problems (Mulder, 2017) that do not have a single right answer. With the challenge driven education approach, the aim is to position ideas, innovations and decision making in the forefront of the learning, including transdisciplinary activities through stakeholder involvement (Tejedor et al., 2018).

The challenge-based learning experience is typically multidisciplinary, takes place in an international context and aims to find a collaboratively identify, analyze and develop or transition to a solution, which is

environmentally, socially and economically sustainable (Malmqvist et al, 2015:4). The CDE activities are often described as an advanced form of project- and problem-based learning (Hoidn & Kärkkäinen, 2014), where the societal focus (rather than just production focus) adds complexity to the problems setting a valuable area for training the cross-cutting competencies of InnoEnergy programs (Kricsfalusy et al., 2018; Chen & Yang, 2019).

4.2 The scenario of Challenge-Driven Education in InnoEnergy MSc programs

The state of the integration of Challenge-Driven education in seven international and cross-border InnoEnergy MSc programs has been analyzed during 2018-2019, aimed to explore the perceived drivers and barriers for CDE; the different approaches for integrating CDE in the seven masters' programs; and the perceived scope for CDE mapped to the achievement of competences for sustainability, as well as the faculty and student perceptions (Högfeldt et al., 2019).

Preliminary findings in the research within the InnoEnergy MSc programs identified several good practices among all programs, consisting in complex and motivating learning opportunities, involving external stakeholders and committed program directors and teachers. Furthermore, the findings revealed a narrow view of sustainability, where the concept is implicitly integrated or “obviously” in some programs with a intend at finding more sustainable energy solutions. Moreover, the InnoEnergy community agreed that the continuous development of the challenge-driven approach in all MSc education programs should target processes for enhancing sustainable energy engineering education and leading the path to transition. The findings from interviewing InnoEnergy program directors and teachers reveal that three of the most crucial aspects for this continuous development are:

- a) a shared understanding of the challenge-driven approach within the knowledge innovation community
- b) faculty development initiatives which target practical aspects of challenge-driven education and
- c) examples on project topics, stakeholders and results which are shared within the community.

4.3 The White Paper on CDE in InnoEnergy

In order to respond to the identified need for a shared understanding, a White Paper was elaborated with the aim to set the goal for the future progress of challenge driven InnoEnergy MSc education, with regards to how Challenge-Driven education is described by the InnoEnergy community and how the EIT Overarching Learning Outcomes are mapped with the Cross-Cutting Key Competencies (Table 1).

The white paper contributes to the concept definition, a strategy on the future development, and introduces some implemented best practices. Furthermore, the overarching learning outcomes (OLOs) for EIT programs and the UNESCO cross-cutting key competences needed for problem solving for sustainable development, were merged as new expected outcomes, so that intended learning outcomes based on both perspectives were developed. Finally, examples of CDE from the InnoEnergy programs are shared to highlight different challenge-driven education approaches implemented so far by the Innoenergy education community.

Table 1: Overarching Learning Outcomes for Challenge-driven InnoEnergy programs. EIT OLOs mapped with SDGs Cross-cutting Key Competencies.

Nr	OLO's corresponding area	Intended learning outcome
1	Anticipatory competence for a sustainable society	The ability to create visions for the future of energy technologies, transitions, storages and systems and to identify, understand and evaluate the short- and long-term future consequences of plans and decisions from an integrated scientific, ethical and intergenerational perspective and to merge this into a solution-focused approach, moving towards the access to affordable, reliable, sustainable and modern energy for all.
2	Innovation, Entrepreneurship and Strategic competency	The ability to collectively develop knowledge, ideas and technology through implementation of innovative actions to create new or significantly improved products, services, processes, policies, new business models or jobs into feasible business solutions that further sustainability.
3	Systems thinking and creativity	The ability to recognize and understand relationships; to analyze complex systems; to think of how systems are embedded within different domains and different scales; and to deal with uncertainty. The ability to think beyond boundaries and systematically explore and generate new ideas.
4	Collaboration competency and Leadership	The abilities to work in cross-disciplinary teams and contexts, to learn from others; to understand and respect the needs, perspectives and actions of others. The ability of decision-making and leadership to deal with conflicts in a group; and to facilitate collaborative and participatory problem solving.
5	Intellectual transforming, critical thinking and Research skills	The ability to transform practical experiences into research problems and challenges, and the ability to use cutting-edge research methods, processes and techniques towards new venture creation and growth.
6	Value judgements and normative competency	The abilities to understand and reflect on the norms and values that underlie people's actions in relation to energy; and to negotiate values, principles, goals and targets, in a context of conflicts of interests and trade-offs, uncertain knowledge and contradictions.
7	Self-awareness and lifelong learning	The ability to reflect on one's own knowledge, skills and abilities as well as one's role in society; to continually motivate and evaluate oneself in the way of taking actions and continuously developing.
8	Integrated problem-solving competency	The overarching ability to apply different problem-solving frameworks to complex sustainable energy problems and develop viable, inclusive and equitable solution options that promote the access to affordable, reliable, sustainable and modern energy for all, integrating the above-mentioned skills and competences.

5 Conclusions

Challenge-Driven education fits well as teaching and learning methodology with the intentions and aspirations in the InnoEnergy MSc education and on the overall EIT level. Challenges in CDE go further the traditional settings, and even project-based learning, since it is to say that they start before and finalise

later, since they come from a societal need and necessarily generate an impact. Indeed, the CDE goals and design are aligned with strategies for higher education at European level.

Moreover, the InnoEnergy community's academic staff and students, as well as involved stakeholders have been satisfied and motivated with the useful collaboration, resulting from challenge-based education. Participants students, teachers and societal and industry actors valued the opportunity to contribute personally to solutions promoting the SDGs, while developing Anticipatory competence for a sustainable society; Innovation, Entrepreneurship and Strategic competency; Systems thinking and creativity; Collaboration competency and Leadership; Intellectual transforming, Critical thinking and Research skills; Value judgements and Normative competency; Self-awareness and Lifelong learning as well as Integrated problem-solving competency.

The different InnoEnergy programs have been working on critical energy challenges on various levels, which can be tackled from the challenge-driven approach for InnoEnergy to lead innovations for sustainable energy. Since the CDE concept and experiences continuous gaining knowledge, all programs will continuously need to nurture and develop the CDE. In this sense, the interest is that programs will be verified to include the SDGs learning outcomes and cross-cutting competences (UNESCO, 2017).

Parallely, the InnoEnergy community acknowledge that higher education success depends mainly on its faculty, staff and students. Therefor the intention raised to support the ongoing successful development of CDE within InnoEnergy through faculty training and through the establishment of a CDE network to promote a shared understanding of the Challenge-driven approach, the sharing of successful experiences within and externally, as well as the advancements of CDE. Finally, the academics perceived ultimately the students to be the drivers for change.

6 References

- Cech, Erin a. 2014. "Culture of Disengagement in Engineering Education?" *Science, Technology & Human Values* 39: 42–72. <https://doi.org/10.1177/0162243913504305>.
- Crawley, E. F., Lucas, W. A., Malmqvist, J., & Brodeur, D. R. (2011). The CDIO Syllabus v2. 0 An Updated Statement of Goals for Engineering Education. *Engineering Education*, 24(2), 2046–2049. Retrieved from http://files.conferencemanager.dk/medialibrary/59856d54-6d1c-4deb-ac21-0dd98ccd0470/images/CrawleyEtAlCDIOSyllabus2.0Paper_17June2011.pdf
- Chen, C.-H., & Yang, Y.-C. (2019). Revisiting the effects of project-based learning on students' academic achievement: A meta-analysis investigating moderators. *Educational Research Review*, 26, 71–81. <https://doi.org/10.1016/j.edurev.2018.11.001>
- Declaration of Barcelona (2004) 1st International Barcelona Conference on Higher Education. <https://eesd15.engineering.ubc.ca/declaration-of-barcelona/> Accessed 28/02/2020
- EIT (2018). Quality for learning: EIT Quality Assurance and Learning Enhancement Model. Handbook for planning, labelling and renewing EIT-labelled Master's and Doctoral programmes. Rev 2018. https://eit.europa.eu/sites/default/files/eit_label_handbook_2018.pdf. Retrieved at 2019-07-09
- Garibay, J.C. (2015) STEM students' social agency and views on working for social change: Are STEM disciplines developing socially and civically responsible students? *J Res Sci Teach* 52: 610–632 <https://doi.org/10.1002/tea.21203>

Högfeldt, A. K., Gumaelius, L., Lantz, A., & Lujara, S. (2018). Understanding engineering education change with the introduction of challenge driven education in Tanzania. In 2018 IEEE Global Engineering Education Conference (EDUCON) pp. 1335-1343. IEEE.

Högfeldt, A-K., Tejedor, G., Gumaelius, L., Segalàs, J. (2019). Bridging Engineering and Sustainability through Challenge Driven Education: a Case Study on Innoenergy Masters of the European Institute of Innovation and Technology. 19th ERSCP - Circular Europe for Sustainability: Design, Production and Consumption, Barcelona, October 15-18, 2019.

Hoidn, S. and K. Kärkkäinen (2014). “Promoting Skills for Innovation in Higher Education: A Literature Review on the Effectiveness of Problem-based Learning and of Teaching Behaviours”, OECD Education Working Papers, No. 100, OECD Publishing, Paris. <http://dx.doi.org/10.1787/5k3tsj671226-en>

Klein JT (2008) Evaluation of interdisciplinary and transdisciplinary research a literature review. *Am J Prev Med* 35(2S):116–123

Knorr-Cetina K (2007) Culture in global knowledge societies: knowledge cultures and epistemic cultures. *Interdisc Sci Rev* 32:361–375

Kricsfalussy, V., George, C., & Reed, M. G. (2018). Integrating problem-and project-based learning opportunities: Assessing outcomes of a field course in environment and sustainability. *Environmental Education Research*, 24(4), 593-610.

Challenging Practice Traditions to Embed Education for Sustainable Development within the Engineering Curriculum

S. Trad¹, R. Goldsmith², R. Hadgraft³ and A. Gardner⁴

¹School of Civil and Environmental Engineering, University of Technology Sydney, Australia

Sloan.Trad@uts.edu.au

²Academic Language & Learning Team, University of Technology Sydney, Australia

Rosalie.Goldsmith@uts.edu.au

³Director, Educational Innovation and Research, University of Technology Sydney, Australia

Roger.Hadgraft@uts.edu.au

⁴Head, School of Professional Practice and Leadership, University of Technology Sydney, Australia

Anne.Gardner@uts.edu.au

Abstract

There has never been a more pressing time than now for Engineering Education for Sustainable Development (EESD). However, Education for Sustainable Development (ESD) remains invisible in most Australian engineering curricula. A common narrative from engineering academics is that ESD is covered by someone else, elsewhere in the curriculum. A similar narrative prevails among 20 interviewed engineers working on an infrastructure project in regional Australia - it's someone else's responsibility. This paper builds on the authors' previous work, which identified a striking resemblance between engineering perceptions of sustainability in an Australian university and on an infrastructure project. The Theory of Practice Architectures (TPA) is used as a conceptual framework to examine the sayings, doings and relatings of 20 engineers and 10 engineering academics interviewed as part of this study. The study found that practice traditions, including masculinity, hierarchical workplaces, and an emphasis on technical competence, constrain sustainability integration in engineering curriculum and in engineering practice. These practice traditions also enable the continuation of narrowly defined engineering work practices, which resist the incorporation of a more holistic approach. Changing practice traditions is not an easy task; however, it is a necessary first step to incorporating ESD within the engineering curriculum.

1 Introduction

As we write this paper, a group of more than 200 scientists forward an open letter to the Australian Government linking climate change to bushfires, and urging our politicians to take immediate action to reduce global warming (Murphy 2020). According to a study recently published by the Climate Council, "The catastrophic unprecedented fire conditions currently affecting NSW and QLD have been aggravated by climate change" (Climate Council 2019). The public sector should not be expected to do all the heavy lifting when it comes to taking action on climate change. The private sector should equally contribute to existential challenges facing our societies. This is especially true for our universities, as universities have a societal moral obligation to graduate students including engineering students capable of tackling the world's complex problems (Trad, 2019).

Our university, University of Technology Sydney (UTS) recently signed the Climate Emergency Declaration. The university pledged to increase the delivery of sustainability education across the curriculum. However, initiatives within the faculty of engineering and IT are still limited to ad hoc

approaches within a handful of existing subjects. The engineering curriculum is overcrowded with technical subjects targeting passive learners. Many Engineering academics view students as “empty vessels” to be filled by whatever they can supply (Friere, 2017) leaving little place for Education for Sustainable Development (ESD). Fitzpatrick, (2017) questions if engineering academics are producing “technically competent barbarians”: engineers who are accelerating humanity along an unsustainable path.

2 Literature Review

2.1 *Technical rationality and Masculinity as dominant features of engineering curriculum*

Engineering is typified as a masculine culture (Godfrey 2009), involving ‘an ideal of manliness, characterised by the cultivation of bodily prowess and individual achievement’ (Wajcman 2010, p.144). Given that the engineering identity centres on the primacy of technical knowledge (Trevelyan, 2012), engineers with a holistic and collaborative approach to problem-solving may be considered as ‘other’ in part because the image of a human-centred, collaborative engineer conflicts with the idea of the engineer as a solitary, male, technical rationalist, tinkering with technology and communicating via calculus. In order to understand how holistic approaches to engineering education and ‘creative visions of engineer’ (Tonso 2006, p.300) are often marginalised in the dominant engineering curriculum, it is useful to explore some ideas of engineering identity, in addition to consider how engineers view the knowledge of their discipline (Goldsmith, Willey & Boud 2018).

The narrowness of the engineering identity emerges in studies of student engineering identities, which reveal strikingly similar images of technical expertise and limited social skills –referred to as ‘the traditional stereotype of the asocial geek’ (Wulf & Fisher 2002, p.36). A student’s perspective on engineering identity, and one which sees ‘othering’ of those who do not conform to the dominant model, is provided by Karen Tonso (2006), who conducted a study of how engineering students form their practitioner identities. Tonso’s study, based on a US engineering school, reveals a male-dominated culture where students who did not fit the images of an engineer as constructed by the campus were ‘othered’ (2006, p.295). Tonso notes that the campus engineer identities emphasised engineering science, which she terms ‘academic science’, and a masculine culture. Her observations about the ‘male-identified ways of life’ (2006, p.298) are reflected in Walker’s study of male and female engineering students in the United Kingdom (2001), Hacker’s research on engineering and desire in the USA (1989) and Lee and Taylor’s critique of the masculinised engineering curriculum in Australia (1996). The masculine qualities of the engineering identity contrast with those seen as desirable by employers, as pointed out in the introduction: collaboration, intercultural competence, and strong oral and written communication skills. Tellingly, Walker notes: ‘Interestingly, these qualities are often characterised as feminine areas where girls and women are assumed to be more capable than boys and men’ (Walker 2001, p.78).

2.2 *Hierarchy and authoritarianism as key features of engineering practice*

Hierarchical organisational structures have existed for thousands of years. Manassee, (2019) defines hierarchal organisational structure as:

“an organisational system where employees are ranked according to status and development of superior and subordinate relationships is critical for organisational success. A workplace that is run on fear and dominance to control subordinates....To increase efficiency and exert control, hierarchical organisations tackle predetermined problems through repetitive stock standard solutions.”

Engineering has streaks of hierarchy in its DNA (Morgan 2002). A hierarchal workplace is characterised by lack of communication, rivalry, inflexibility, threats and intimidation embracing hierarchy and resisting change (Adorno, Frenkel-Brunswik, Levinson, & Sanford, 1950). According to de Pellis & de

Pellis, (2008) several studies have found strong traces of authoritarianism in the form of hostility to women and resistance to diversity within engineering classroom and curricula (Chesler & Chesler, 2002; Elaine, 1995; Gallaher & Pearson, 2000; NAS, 2006; O'Halloran, 2005; Roberts & Ayre, 2002; Burack & Franks, 2006).

2.3 *Technical rationality, hierarchy, authoritarianism and masculinity*

“Engineers value social hierarchy on a continuum giving most prestige to scientific abstraction, least to feminine qualities” (Hacker, 1981). Such values are transmitted to engineering students through engineering curricula. These values can also be interpreted as norms: “norms regarding what it means to be ‘manly’, are enacted in plain sight in the field of engineering but are treated as invisible and go largely unchallenged” (Akpanudo et al., 2017, p.2). The practice traditions of engineering curricula and engineering practices which enshrine masculinity, hierarchy and technical rationalism as the dominant way of being an engineer: enable certain practices while constraining others. We argue that the straitjacketing of cultural and language practices in these practice traditions thus constrain the integration of sustainability into the curriculum and into workplace practices respectively; there is no language with which to speak about sustainability as a valued concept, approach, or practice. It is constantly ‘othered’, referred to as an externality, as something to be taught outside of the engineering science subjects of the curriculum, to be spoken of only as a cost, or in dollar terms in engineering workplace practices, to be regarded as something that will ‘muddy the waters’, or hamper the delivery of technical solutions.

3 Methodology/methods

The study uses the Theory of Practice Architectures (TPA) as a conceptual lens to compare engineering curriculum and practice. TPA has been previously used to understand complex phenomena such as professional learning (Kemmis et al., 2014), curriculum renewal (Goodyear, Casey & Kirk, 2016) or team and project work in engineering practices (Buch & Andersen, 2015).

TPA has evolved from Schatzki’s practice theory (Mahon et al., 2017), where the focus is on the site of practice, how the practice is conducted, its temporal and physical location, and the arrangements that hold it in place. TPA can allow investigators to see not only what is happening in a practice, but how this has come to be and why certain practices become ‘the way we do things around here’. In keeping with Schatzki’s understanding of the localised nature of practices, TPA is used to analyse a site of practice; a site of practice is ‘that realm or set of phenomena of which it is a part’ (Schatzki, 2003 cited in Mahon, Kemmis, Francisco, & Lloyd, 2017, p. 9).

In this study, sites of practice are the engineering subjects taught and the construction of an infrastructure project delivered by the participants respectively. To change a practice, a better understanding of the unfruitful practices and how they came about is required.

According to TPA a practice is held up by the following three pillars that exist simultaneously in a practice:

- *Sayings*: What is said and understood about a practice forms resources made possible by cultural-discursive arrangements
- *Doings*: What is done in a practice, including the physical environment, financial and temporal resources, forms resources made possible by material-economic arrangements
- *Relatings*: The power in relationships amongst participants and non-human objects in a practice, forms resources made possible by social-political arrangements

Culture-discursive, material-economic, and social-political arrangements should not be considered or analysed separately; rather they are bundled together to prefigure (but not predetermine) the happenings of a site of a practice.

4 Findings

The following table analyses the similarities between the engineering curriculum and engineering work practices, through a TPA framework.

Table 1 Masculinity Enacted in curriculum and project

Curriculum	Practice
Sayings	
Masculine identity; speaking of ‘hard skills’ vs ‘soft skills’; ‘referring to mathematical and interpersonal skills as ‘hard and ‘soft’ respectively reinforces the idea that mathematical skills are connected to intellectual rigor as well as to masculinity and virility, while interpersonal skills are less important, and related to weakness and impotence’ (de Pillis, E., & de Pillis, L. 2008)	Masculine identity: teasing a colleague for driving a sedan rather than a utility vehicle;
Doings	
The focus on advanced mathematics, with its intense workload as part of the student engineering identity	Technical competence and physical endurance; driving a utility vehicle;
Relatings	
The ‘weeding out culture’ - more pronounced in the engineering curriculum than in other STEM disciplines (Seymour & Hewitt 1997); a culture which valorises masculine qualities of competitiveness, high marks for mathematical & scientific knowledge; ‘[s]tudents more likely to perform creative visions of engineer were also less likely to be thought of as engineers who should be part of determining what “real” engineering might be’ (Tonso 2006, p.300)	masculinised relationships (sustainability othered or left at the door); the dominance of the site manager ‘laying pipes’ rather than the project manager on the water project

Table 2 Technical rationality enacted in curriculum and project

Curriculum	Practice
Sayings	
‘it’s not my job to teach writing’; ‘sustainability is taught somewhere else’;	‘If they are not concrete outcomes they are not outcomes’

Doings	
Engineering science curriculum which focuses on mastery of technical knowledge; exam-focused teaching – emphasises reproducible knowledge; results focus of engineering group work projects leads to a ‘divide and conquer orientation’ to studying, resulting in a strong emphasis on individual work (Gonsalves et al. 2019, p.14).	Arriving late to sustainability meetings only. Missing sustainability meetings ‘for more important work’; Sustainability is omitted from client-contractor contract
Relatings	
The transmission of knowledge from the knowledgeable lecturer to the ignorant students creates a relationship where the lecturer holds the power and is in a dominant position; students are then constructed as docile and passive recipients (Lee & Taylor 1996) of knowledge (Goldsmith 2018)	Omitting sustainability from contract upon contractor request eliminates contractual responsibility increasing power of contractor to control project sustainability while reducing accountability.
Trevelyan argues that ‘[b]uilding students’ capacity for solitary technical problem-solving remains the central objective of engineering education’ (2012, p. 4).	Incentivising sustainability rather than making a responsibility paints a picture that is something nice to have

Table 3 Hierarchy and Authoritarianism enacted in curriculum and project

Curriculum	Practice
Sayings	
‘My subject does not need to change’;	Lack of communication; ‘The doors are always open from the inside’
Doings	
Class configurations; Emphasis on assessments, rewarding and punishing students; Inflexibility in subjects; Marks used for behavioural control rather than achieving learning objectives.	Office configurations with Project Manager having an office overlooking engineers; Going to breakfast with senior engineers only on a daily basis; Buying coffees for engineers with higher status only
Relatings	
Resisting change to subjects as a form of control of curriculum giving academics power over curriculum; Clear power differential between academics and students through hierarchal relationships; control over teaching and assessment assigning most of the power to academics in the engineering student-lecturer relationship	“Engineers value social hierarchy on a continuum giving most prestige to scientific abstraction, least to feminine qualities” (Hacker, 1981).

5 Discussions/Recommendations

Engineers Australia's Code of Ethics clearly mandates Australian engineers to '*promote sustainability*'. Through responsible engagement and sound engineering practice, engineers are expected to '*balance the needs of the present with the needs of future generations*'. Universities have a pivotal role in shaping the graduate engineer identity; however the study has shown that real EESD is not happening at Australian universities, perhaps for the following reasons:

1. Engineering curricula are overcrowded with technical subjects, which are mostly theory-based and emphasise analysis rather than design
2. There is a clear academic hierarchy, with senior engineering academics exercising authority over discipline subjects and
3. EESD is othered, with most academics stating that it is '*someone else's problem*'.

Challenging the dominant masculine engineer identity and integrating sustainability into engineering practice and curriculum is not an easy task. Ad hoc approaches to incorporating sustainability into the engineering curriculum and small steps in greening the built environment continue to fall short from what is required to safeguard the planet for future generations. Shifting current structures holding engineering education and engineering practice in place, is fundamental to incorporating sustainability in curriculum and practice.

From TPA's perspective, the notion of ecologies of practices arises here. Practice ecologies are a series of interconnected webs (Sayings, Doings and Relatings arrangements) essential to sustain a practice. Kemmis et al. (2014, p. 50) note that 'practices can sustain or suffocate other practices, and different ecologies of practices may be hospitable to some practices and not to others'. The practice of "engineering" dominates and dictates sub-practices (EESD and engineering practice for sustainability), bringing to mind the concept of whether EESD can actually exist within a traditional approach to engineering. This theory is bolstered by the fact that most sustainability consultants on infrastructure projects come from disciplines other than engineering.

An initial step to overcome this issue would be to acknowledge sustainability as part of the engineering discipline – a sub-practice – and not something exterior.

Engineering curricula need to adequately cover sustainability. Technical and sustainability competencies should be covered in the same subjects, providing real life examples to students that sustainability is not just 'a nice thing to have'.

Students are not naïve empty vessels and should not be indoctrinated by technical experts. Rather, upon entering university, engineering students should be given the power to judge academic credibility. After all, it is their own future they will engineer.

6 Conclusions

The dominance of hierarchy, technical competence and masculinity within engineering curriculum and practice continue to lead engineering down an unsustainable path, a path leading to a world that is not worth living in. Changing engineering education is required right now to improve engineering's social and environmental impacts moving into the future.

Changing a practice by adding more stuff to do or asking practice participants to know one additional thing does not lead to change. For change to happen the practice architectures that are in place need to be challenged. If the practice is the curriculum or engineering practice ad hoc approaches will not work. This is not a new concept though and has been around for a long time. The culture-discursive, material-economic and social-political arrangements will need to shift to allow ESD to be thought of and spoken

of as integral to engineering studies and work practices, to be enacted as part of what engineering is, and to be valued as a core tenet of engineering teachings and practices.

References

- Adorno, T. W., Frenkel-Brunswick, E., Levinson, D. J., & Sanford, R. N. (1950). *The authoritarian personality*. New York: Harper
- Akpanudo, U.M., Huff, J.L., Williams, J.K. & Godwin, A. 2017. Hidden in plain sight: Masculine social norms in engineering education, *Proceedings of the Frontiers in Education Conference 2017*.8
- Burack, C., & Franks, S. E. (2006). Telling Stories about Engineering: Group Dynamics and Resistance to Diversity. In J. M. Bystydzienski & S. R. Bird (Eds.), *Removing Barriers: Women in Academic Science, Technology, Engineering, and Mathematics* (93–107). Bloomington and Indianapolis: Indiana University Press.
- Buch, A., & V. Andersen. 2015. “Team and Project Work in Engineering Practices.” *Nordic Journal of Working Life Studies*, 5 (3a), 27–46
- Chesler, N. C., & Chesler, M. A. (2002). Genderinformed mentoring strategies for women engineering scholars: On establishing a caring community. *Journal of Engineering Education*.
- Climate Council 2009, ‘This is Not Normal’: Climate change and escalating bushfire risk, Australia, November 2019, Briefing Paper, viewed 03 February 2020, <https://www.climatecouncil.org.au/wp-content/uploads/2019/11/bushfire-briefing-paper_18-november.pdf>
- de Pillis, E., & de Pillis, L. 2008. Are engineering schools masculine and authoritarian? The mission statements say yes, *Journal of Diversity in Higher Education*, 1 (1), 33-44.
- Elaine, S. (1995). The loss of women from science, mathematics, and engineering undergraduate majors: An explanatory account. *Science Education*, 79 (4), 437–473.
- Fitzpatrick, J.J. 2017, “Does engineering education need to engage more with the economic and social aspects of sustainability?”, *European Journal of Engineering Education*, 42 (6), 916-926.
- Freire, P., & Ramos, M. 2017, *Pedagogy of the oppressed*. London, England: Penguin Books.
- Gallaher, J., & Pearson, F. (2000). Women’s perceptions of the climate in engineering technology programs. *Journal of Engineering Education*
- Goodyear, V. A., A. Casey, and D. Kirk. 2016. “Practice Architectures and Sustainable Curriculum Renewal.” *Journal of Curriculum Studies*.
- Godfrey, E. 2009, ‘Exploring the culture of engineering education: the journey’, *Australasian Journal of Engineering Education*, 15 (1), 1-12.
- Godfrey, E. & Parker, L. 2010, ‘Mapping the cultural landscape in engineering education’, *Journal of Engineering Education*, 99 (1), 5–22.
- Goldsmith, R., Willey, K. & Boud, D. 2018, ‘Investigating invisible writing practices in the engineering curriculum using practice architectures’, *European Journal of Engineering Education*, published online 16 November 2017.
- Gonsalves, A.J., Silfver, E., Danielsson, A. & Berge, M. 2019, “It’s not my dream, actually”: students’ identity work across figured worlds of construction engineering in Sweden. *International Journal of STEM Education*, 6 (13)

- Hacker, S. 1989, *Pleasure, power and technology: some tales of gender, engineering, and the cooperative workplace*, Unwin Hyman, Winchester, MA.
- Kemmis, S., J. Wilkinson, C. Edwards Groves, I. Hardy, P. Grootenboer, & L. Bristol. 2014. *Changing Practices, Changing Education*. Singapore: Springer
- Lee, A. & Taylor, E. 1996, 'The dilemma of obedience: a feminist perspective on the making of engineers', *Educational Philosophy and Theory*, 28 (1), 57-75.
- Manassee, J.M. 2019, 'Trust in hierarchical leadership: The moderating effect of need for cognition', Master thesis, Azusa Pacific University, California
- Morgan, L. M. 2002, 'The Moral Ethos of Managing in an Engineering Culture', PhD Thesis, The University of San Francisco, San Francisco
- Mahon K., Kemmis S., Francisco S. & Lloyd-Zantiotis A. Introduction: Practice Theory and the Theory of Practice Architectures. In: K. Mahon, S. Francisco & S. Kemmis (Eds.), *Exploring education and professional practice: Through the lens of practice architectures*. Singapore: Springer, p. 1-30, 2017
- Murphy, K. 2020, 'Scientists call on MPs to urgently reduce Australia's emissions amid bushfire crisis', *The Guardian*, 02 February, viewed 03 February 2020, <<https://www.theguardian.com/australia-news/2020/feb/03/scientists-call-on-mps-to-urgently-reduce-australias-emissions-amid-bushfire-crisis>>
- NAS. (2006). *Beyond Bias and Barriers: Fulfilling the Potential of Women in Academic Science and Engineering*. Retrieved February 20, 2007, from <http://www.nap.edu/catalog/11741.html#toc>.
- O'Halloran, J. (2005). *Mentorlink: Changing the Culture of Engineering*. Retrieved April 1, 2005, 2005, from <http://mentorlink.ie/pubs/johart.pdf>
- Rieckmann, M. 2012, "Future-oriented higher education: which key competencies should be fostered through university teaching and learning?", *Futures*, 44 (2), 127-135.
- Roberts, P., & Ayre, M. (2002). Did she jump or was she pushed? A study of women's retention in the engineering workforce. *International Journal of Engineering Education*, 18 (4), 415–421.
- Roorda, N. 2013, "'A strategy and a toolkit to realize system integration of sustainable development (SISD)", in Caeiro, S., Filho, W.L., Jabbour, C. and Azeiteiro, U.M. (Eds), *Sustainability Assessment Tool in Higher Education Institutions Mapping Trends and Good Practices around the World*, Springer International Publishing, Basel, 101-119.
- Schatzki, T. A Primer on practices. In J. Higgs, R. Barnett, S. Billett, M. Hutchings & F. Trede (Eds.), *Practice-based education*. Rotterdam: Sense Publishers, 2012.
- Tonso, K. 2006, 'Student engineers and engineer identity: campus engineer identities as figured world', *Cultural Studies of Science Education*, 1, 273-307.
- Trad, S.P. 2019, "A framework for mapping sustainability within tertiary curriculum", *International Journal of Sustainability in Higher Education*, 20 (2), 288-308.
- Trevelyan, J. 2010, 'Mind the gaps: engineering education and practice', *Proceedings of the 2010 AAEE Conference*, Sydney, 5-8 December.
- Trevelyan, J. 2012, 'Why do attempts at engineering education reform consistently fall short?', *Proceedings of the 2012 AAEE Conference*, Melbourne, Victoria, 3-5 December.
- Wajcman, J. 2010, 'Feminist theories of technology', *Cambridge Journal of Economics*, 34, 143-52.

Wulf, W.A. & Fisher, G.M.C. 2002, 'A makeover for engineering education', *Issues in Science & Technology*, 18 (3), 35-39.

Emotional Intelligence for sustainable engineering education: incorporating soft skills in the capstone chemical engineering capstone design project

E. Tsalaporta

School of Engineering, University College Cork, Republic of Ireland

eleni.tsalaporta@ucc.ie

Abstract

Chemical engineering students in universities across the world are involved in at least one chemical engineering design project during their studies. Traditionally, the concept of design in chemical engineering education has been associated with the design of processes, equipment and products, with extensive focus in technical knowledge, creative thinking, problem solving, common sense and efficiency. But are these skills enough for chemical engineering graduates to shine and make a difference in their careers?

While engineering education focuses on the establishment of hard skills, it pays little or no attention to the soft skills that are necessary for the careers of engineering graduates. Conversely, sustainable engineering education considers soft/social skills, such as the ability to work in teams, empathy, self-motivation and self-regulation, a key element of engineering curricula.

In order to maximise the potential of sustainable engineering education and prepare the students for the real work life challenges, in a team-driven learning format, as opposed to a student-centred approach, a “collaborative working strategy” (Mitchell, 2008) was introduced to the capstone design project. A personality mapping and a set of collaborating working values and behaviours were introduced as part of the project, in order to examine the extent to which emotional intelligence enhances collaborative teamwork in engineering education.

More specifically, the students were asked to map their personalities and working styles in order to explore the dynamics of their team. The personality test that was used for this purpose was “The Insights Discovery, the colour personality test”, based on Carl Jung’s model for personality types. Having mapped their working style strengths and weaknesses, the teams were asked to adhere to a set of values including 1) common goal and unity of purpose, 2) team trust, 3) interdependence, 4) accountability and 5) effective feedback. These values were used as a guideline for effective communication, while the students were asked to monitor, list and reflect on the collaborative working behaviours of them and their peers, as part of their weekly tasks.

The preliminary findings of this ongoing study have indicated that emotional intelligence enhances the effectiveness of project team working, providing the necessary evidence that emotional intelligence holds a dominant role in sustainable engineering education and should be part of the engineering curriculum.

1 Introduction

Sustainability is a philosophy of personal development, professional life and community engagement and is linked to soft skills, moral values and ethos (de La Riva de la Riva et al., 2015). The concept of sustainability in engineering education has been well addressed and linked to climate change,

environmental impact, resource and component depletion, mainly focusing on sustainable development (e.g. Desha et al, 2007; Ashford, 2004; Thompson, 2002; Tryggvason and Diran, 2006; Sanderson, 2008; Tsalaporta et al. 2018).

Emotional Intelligence is the ability to understand, use, manage emotions and empathise in order to communicate effectively, overcome challenges and defuse conflict. Emotional intelligence has been associated with enhanced individual and group work performance (e.g. Goleman, 1998a; Goleman, 1998b; Goleman et al, 2002; Druskat and Druskat, 2006). Boyatzis et al. (2016) have conducted a research study assessing the effectiveness of engineers at a multinational manufacturing company along with their IQ, personality, and emotional intelligence. They concluded that emotional intelligence was the only factor to predict the effectiveness of the participants. Despite the evidence, emotional intelligence has been underestimated and almost excluded from engineering education.

Recently, researchers have linked sustainable development to emotional intelligence, considering emotional intelligence a dimension of sustainability, therefore a key element in sustainable engineering education. Bheekhun et al. (2018) have concluded that a blend of engineering, scientific and technical knowledge, in addition to management, innovation, economic, communication, and more importantly ethical and moral knowledge and skills are the basics for designing a sustainable engineering curriculum.

2 Emotional Intelligence in the chemical engineering capstone design project

The work profile of chemical engineers has drastically changed since the industrial revolution. In the past, chemical engineering was a solo job and chemical engineers were classified as highly intelligent, technically rigorous and innovative individual contributors, working independently to provide solutions in the space of a lab/factory/production line. Nowadays, chemical engineering has moved beyond this simplistic approach. Contrary to old images and perceptions, chemical engineers are part of and lead multidisciplinary/transdisciplinary teams, their working spaces are not necessarily labs or factories and they hold meetings with diverse clients in multi-cultural contexts, being at the front line of their companies.

In order to meet the new needs of their profession, some essential skills for chemical engineering graduates when entering the workforce are social skills, such as the ability to work in teams, empathy, self-motivation and self-regulation. The chemical engineering capstone design project is the opportunity for chemical engineering students to work effectively as part of a team and develop soft skills such as self-awareness, self-management, empathy, and relationship awareness.

The capstone design project (PE4050) of the department of Process and Chemical Engineering of UCC focuses on the design of an industrial plant, a product or a process in a team-driven learning format, as opposed to the traditional single student-centred approach; therefore, it is the perfect platform to implement real work life conditions and challenges, to monitor the impact of emotional intelligence and relate it with team performance. Fourth year students (either Bachelor's or Master's) are working in teams of 5 or 6 in order to create their own manufacturing facility. The incorporation of emotional intelligence in the design project is aiming to allow the students to reinforce and apply subject knowledge, whilst developing key soft skills such as teamwork and communication; the design tasks are aiming to develop critical thinking, problem solving, active learning, sense of responsibility, safety, environmental sensitivity and energy saving, but also to determine how well they manage themselves and work with others.

3 Methodology

A case-study approach was adopted for in-depth analysis of the role of soft skills on the capstone design project. Initially, the profile of the class was analysed and the students were allocated in groups. More specifically, there were 64 students, 47 of whom were male and 17 female, and were allocated in 12 groups of 5 or 6 members. Instead of working in teams of their preference, the students were randomly allocated in groups, in order to simulate real life working conditions. 12 topics were introduced to the 12 groups and the newly developed groups were asked to choose 3 topics of their preference.

At this early stage for the groups, the choice of the topics was an actual challenge; this was the driving force for the incorporation and investigation of the collaborative working strategy (Mitchell, 2008), as an educational tool in team projects such as the design project. More specifically, a personality mapping (Insights Discovery Test) and a set of collaborating working values and behaviours were introduced as part of the project, in order to examine the extent to which emotional intelligence could enhance collaborative teamwork in engineering education.

3.1 The Insights Discovery Test (<http://www.seveninstitute.co.uk/insights-discovery/>)

In order to explore their working styles as well as the dynamics of their groups, the students were asked to map their personalities and behaviours. The personality test that was used for this purpose was “The Insights Discovery, the colour personality test”, based on Carl Jung’s model for personality types. As seen in Figure 1, this personality test uses 4 colours (blue, red, green and yellow) to describe different personalities:

Fiery Red: Individuals with a high amount of fiery red are competitive, strong minded and focused on results, while the interaction with others is characterized by determination.

Sunshine Yellow: Enthusiastic personalities with strong social skills, they encourage participation and they enjoy to be involved in group work.

Earth Green: Altruism could well describe this type of personality; they are seeking harmony, are caring and patient.

Cool Blue: Accuracy, observation and preciseness and a genuine desire to know and understand are some of the characteristics of these individuals.

Each person is a unique combination of these four colours, which determines one’s personal style and behaviour at work. The students had to complete a short questionnaire, reflect on their strengths and weaknesses based on their unique colour profile and finally share their profile with their group as well as the lecturer, in order to help others to understand their personality and work together in harmony. The results are provided and discussed later.



Figure 1. Colour personality mapping

3.2 Collaborative working strategy

Table 1. Team Assessment Tool (TAT) for assessing the collaborative working strategy in the capstone design project (PE4050) of UCC

Team assessment Tool (TAT)	Positive	Neutral	Negative
Sense of understanding of Emotional Intelligence (EI) and its importance			
Emotional Intelligence is linked to sustainability			
Sense of team			
Recognising others feelings			
Trust among team members			
Empathy among team members			
Professionalism among team members			
Understanding of competencies of team members			
No blame culture in the team			
Peer learning among team members			
Confidence that the design project would be delivered on time			
Confidence that the quality of the delivered design project would be good			
Belief that the collaborative working strategy set the basis for effective team communication			
Belief that the collaborative working strategy helped to overcome problems			

Having mapped, shared and discussed their working style strengths and weaknesses, the twelve groups were asked to adopt and apply the collaborative working strategy as described by Mitchell (2008). The twelve groups were asked to adhere to a set of values including 1) common goal and unity of purpose, 2) team trust, 3) interdependence, 4) accountability and 5) effective feedback. These values were used as a guideline for effective communication, while the students were asked to monitor, list and reflect on the collaborative working behaviours of them and their peers, as part of their weekly tasks.

More specifically, the students were asked to adopt some effective team working behaviours, individually but also as part of their group, as follows:

- Act as a team, not as a group: set a structure in your team by choosing (or not choosing) a team leader;
- Listen effectively: listen to understand, not to respond;

- Share and discuss ideas before taking action;
- Consider other team member's views, experiences and see things from their perspectives;
- Be clear: explain what you expect from others and understand what they expect from you;
- Distribute responsibilities and do what you agreed to do;
- Be professional: personally commit to the delivery of the project;
- Recognize achievements;
- Challenge below standard behaviours in a constructive manner;
- Be open with your problems and try to resolve them together as a team.

These behaviours aimed to provide a structured context in which individual and group emotional intelligence was enhanced in a direct or indirect manner, with the anticipated benefits being: a) sense of team/enhanced team spirit, b) effective team work c) improved communication, d) conflict resolution and e) team learning.

At the end of the semester, the students had to evaluate to which extent the shared values and behaviours had accomplished their purpose and to which extent the anticipated benefits were met, by completing a questionnaire (Team Assessment Tool) that was developed for the purposes of this article, as well as writing a personal reflection. The Team Assessment Tool (TAT) has the form of a quick questionnaire and aims to assess to what extent the collaborative working strategy is applicable in the capstone design project. The TAT is presented in the table above. The personal reflections provided a number of common findings which are presented below.

5 Results and Discussion

5.1 The Insights Discovery Test

The Insight Discovery Test mapped very accurately the working styles of the students, proving that it is a very useful tool for both the students and the lecturer. Through this test, the students were able to recognise their individual strengths and weaknesses and associate them with their working styles, as well as the working style of their group peers. The lecturer was able to use the personality mapping to predict the dysfunctional groups and in the future prevent this dysfunctionality by ensuring that there is a variety and balance among the personality colours in each group.

More specifically, the personality profiles of a group of five students are presented unanimously in Figure 2. In this team, the dominant colours of the team members are blue, green and yellow. The red is present but not dominant in any of the team members. This team was well organised, with all the team members being very diligent. This was reflected in the meetings with the lecturer/mentor, where the team was using this time effectively, looking at the project holistically, having prepared questions and keeping notes. However, while the team members were motivated and hard-working, there was a lack of leadership and confidence in their work.

Other teams had the opposite problem. More specifically, there were three teams with the majority of the members having a red type of personality. In the meetings with these teams, it was obvious that there were different views among the team members and occasionally were using this time to discuss and take decisions. Moreover, the members of these teams had a tendency to focus on the individual element (design memo) of their work, as opposed to the actual design project.

The teams, with the yellow element dominant, had a tendency to underestimate the amount of work associated with this module. In the meetings with the lecturer/mentor, the team members were overoptimistic, with almost a lack of sense of reality, regarding the deliverables of the project. On the other hand, the teams with green element dominant, had a tendency to focus on less important aspects of the design project, showing limited ability to set priorities.

The outcomes from this ongoing research are at a preliminary stage and more samples are required in order to come to a safe conclusion. However, the Insights Discovery Test could be used retrospectively, prior to the formation of the groups at the beginning of the semester, in order to investigate to what extent a colour personality balance could be beneficial in this team project.

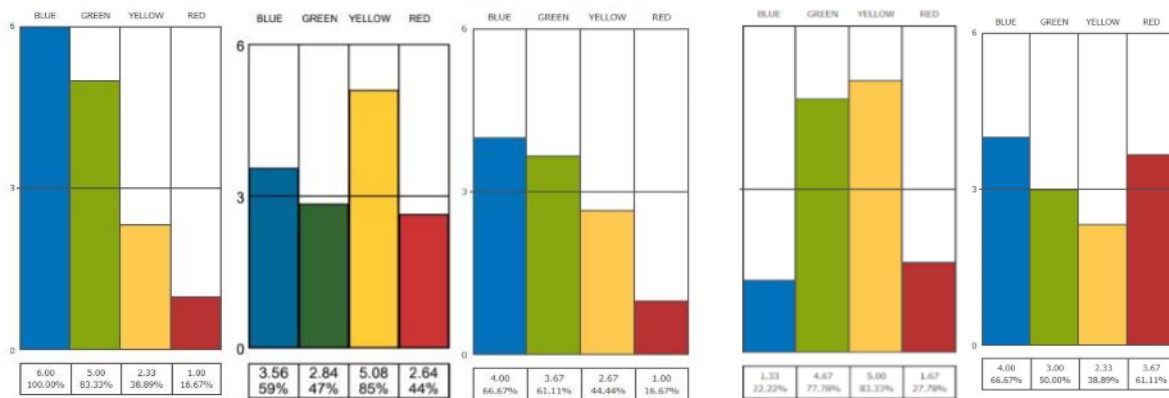

Figure 2. Colour personality mapping of a group of five students

5.2 Collaborative working strategy

The Team Assessment Tool (TAT) provided a baseline for the assessment of the collaborative working strategy. The students found the effective team working behaviours useful, with their experience and feedback being very positive, as seen in Table 2. The vast majority of them found the collaborative working strategy very beneficial regarding team structure, communication and team members' relationships, reflecting very positively in the productivity and the quality of their work.

This outcome was further supported by the students' personal reflections that provided very useful insights in relation to the dynamics of their groups. A summary of the findings of the personal reflections are:

- The biggest challenge of the design project is group work;
- Listening to understand was a very difficult skill to develop;
- Working effectively in groups is essential for engineers;
- Peer learning is a strong element of group work;
- Interpersonal skills like patience, communication and empathy are key elements for engineers to effectively complete group projects;
- The design project was the most challenging but also rewarding experience of the curriculum.
- Emotional Intelligence is part of sustainable thinking and sustainable engineering.

Table 2. Team Assessment Tool – results

Team assessment tool (TAT)	Positive (%)	Neutral (%)	Negative (%)
Sense of understanding of Emotional Intelligence (EI) and its importance	95.5	3	1.5
Emotional Intelligence is linked to sustainability	98.5	1.5	0
Sense of team	80	4.5	15.5
Recognising others feelings	63	6	31
Trust among team members	66	4.5	29.5
Empathy among team members	64.5	26.5	9
Professionalism among team members	61.5	6	32.5
Understanding of competencies of team members	54	31.5	14.5
No blame culture in the team	57	30	13
Peer learning among team members	70.5	3	26.5
Confidence that the design project would be delivered on time	94	0	6
Confidence that the quality of the delivered design project would be good	51	22	27
Belief that the collaborative working strategy set the basis for effective team communication	98.5	1.5	0
Belief that the collaborative working strategy helped to overcome problems	95.5	4.5	0

6 Conclusions

This paper has investigated the incorporation of soft skills in the capstone chemical engineering capstone design project, as part of a sustainable engineering curriculum. Emotional intelligence, as a dimension of sustainability, has enhanced the effectiveness of project team working.

The outcomes from this ongoing research are at a preliminary stage and further research is required in order to come to a safe conclusion. However, the Insight Discovery Test has mapped very accurately the working styles of the students, proving that it is a useful tool in engineering education. The collaborative working strategy and the TAT provided a structured context in which individual and group emotional intelligence was enhanced in a direct or indirect manner.

References

Mitchell, A. (2008) Thameslink Programme: collaborative working strategy, London: Network Rail.

<http://www.seveninstitute.co.uk/insights-discovery/> .Questionnaire. September 2019.

de la Riva de la Riva, G.A., Espinosa Fajardo, C.C. and Juárez Nájera, M. (2015) Sustainability in engineering education: an approach to reach significant learning and character skills. *Sustainability in Higher Education*: 97-125.

Desha, C., Karlson, C., Michael, H. S., & Peter, S. 2007. The Importance of Sustainability in Engineering Education: A Toolkit of Information and Teaching Material. *In: Engineering Training and Learning Conference, Sept. 12-13, Australia.*

Ashford, N. 2004. Major Challenges to Engineering Education for Sustainable Development: What Has to Change to Make it Creative, Effective, and Acceptable to the Established Disciplines? *International Journal of Sustainability in Higher Education*, **5**, 239-250.

Thompson, G. 2002. Status and prospects of sustainable engineering education in some American universities. *In: Engineering Education in Sustainable Development Conference - Delft University of Technology, Oct. 24-25, Netherlands.*

Tryggvason, G., & Diran, A. 2006. Re-engineering Engineering Education for the Challenges of the 21st Century. *Opinion in JOM*, 14-17.

Sanderson, T. 2008. A Slow But Certain Demise. *The Guardian*, 30/10/2008.

Tsalaporta, E., Fitzpatrick, J.J. and Byrne, E.P. (2018) Cycling for a sustainable future: Considerations around the Development of a Masters Level Module on Carbon Capture, Sequestration and Utilisation, *Proc. Engineering Education for Sustainable Development 2018*: 149-157.

Druskat, V. and Druskat, P. (2006) Emotional intelligence in project working, in S. Pryke and H. Smyth (eds.), *The Management of Complex Projects*, Oxford: Blackwell Science.

Goleman, D. (1998a) Working with Emotional Intelligence, New York: Bantam Books.

Goleman, D. (1998b) What makes a leader? *Harvard Business Review*, 82 (1) 82-91.

Goleman, D., Boyatzis, R. and McKee, A. (2002) *The New Leaders*, Boston: Harvard Business Press.

Boyatzis, R., Rochford, K. and Cavanagh, K.C. (2017) Emotional intelligence competencies in engineer's effectiveness and engagement. *Career Development International*, **22**, 70-86.

Bheekhun, N. and Abu Talib, A.R. (2018) From Sustainable Engineering Education to Knowledge Transfer: A Preview, 2018 International Conference on Multidisciplinary Research Track 1: Science, Technology, Engineering & Mathematics.

Sustainability, pandemic and women in academia: breaking the “good girl” culture to enhance sustainability in engineering education

Eleni Tsalaporta¹, Elizabeth Kyte² and Maria Sousa Gallagher¹

¹School of Engineering, University College Cork, Republic of Ireland

²Independent Gender History Scholar, Cork, Republic of Ireland

eleni.tsalaporta@ucc.ie

Abstract

We would all agree that the role of sustainable development is to enable all people throughout the world to satisfy their basic needs and enjoy a better quality of life, without compromising quality of life for future generations. We would agree that sustainable development relies on ending discrimination towards women and providing equal opportunities for education and employment. Gender equality has been conclusively shown to stimulate economic growth, which is crucial for low-income countries. We would also agree that there has been a lot of research in relation to sustainable development in engineering education, indicating that the subject of sustainability may help increase participation of women in engineering. But in reality, how can we teach our students sustainable development and promote the role of females in engineering, when the engineering education is so unsustainable for female academics?

Academic women have long made the compromises in terms of the double burden of domestic and paid work, as well as to their personal life choices and well-being, yet academia and higher education institutions have simply not made the working environment a more just and sustainable space for women. During the pandemic, these inequities were exacerbated by the loss of educational provision, now delivered online and facilitated by, in the majority of cases, mothers. The precarity of childcare, now makes the question of the unsustainability of female academic's lives unavoidable. Women have been literally and figuratively left holding the baby during this crisis. We are at a critical juncture where we have the opportunity as academics, to reimagine the post-pandemic community, and create a more socially just and sustainable balance in our lives.

This issue exceeds academia; it is actually the culture that dictates women to be “good girls”; to comply with the patriarchal system. While there is nothing wrong about being a good person, the “good girl” label has a completely different meaning and impact on the life and career of women. “Good girl” is the one who cares about the others, seeks their approval, has no needs or ambitions, is quiet, kind, willing to please everyone, to get everything right the first time, is not allowed to make mistakes, has to sacrifice herself, and to be perfect and above all else, not to challenge the system or to call out all the specifically gendered ways in which the impact of the system marginalises and hurts women. The “good girl” culture has been a big burden for women in academia in general, having a detrimental impact to the career development of female academics in particular in the male dominated sector of engineering education. During the pandemic, it has been taken for granted that women would deliver on all fronts. It is well document that women's work is often invisible, both in the domestic and public spheres^[1]. Although common to all disciplines, the impacts of bias and stereotypes are particularly pronounced in engineering^[2]. Female academics please their students, line managers, colleagues and family, leaving behind themselves, their

research and other necessary elements for their progression. They are never considered equally good, impactful, and successful, as their male colleagues. As a matter of fact, women in engineering education experience more grade appeals and receive lower course evaluations than their white male counterparts^[3], being discriminated by students, administrators and academics, while their efforts and ideas are being constantly discounted. There is nothing sustainable about this.

This paper proposes effective actions to tackle the “good girl” expectations for female academics, enhancing sustainability, implementing a fit-for-purpose change of the culture system across school, with targeted and consistent actions, actively promoting the needs of female academics.

1 Introduction

It is not new that women are the mostly affected by pandemics^[4]. As a matter of fact and despite the societal progress, development and awareness, the social and economic impacts of COVID-19 have fallen once more harder on women than on men, with mothers being pushed out of leadership roles, reducing their working hours or quitting, as a result of the pressure of holding multiple roles, minding and home-schooling their kids, while being challenged and compared with their male colleagues^[5]. While the pandemic is not over yet, the statistics are already extremely worrying; in Ireland, already 10% of women have quit their jobs in order to mind their kids, while 65% of families report the mother is taking full responsibility for home-schooling^[6].

The detrimental effect of Covid-19 to the career development and progression of females is even more disproportionate in academia^[7], and more specifically in the male dominated academic environment of engineering. Female academics in engineering were already the exception rather than the rule prior to the recent pandemic, and, it is expected that this small “tribe” will go into extinction, unless serious actions are being taken to support not only women in engineering academia, but also the “ecosystem” of female engineers in general, leading to the loss of sustainable development in engineering in terms of gender inclusivity. So, as engineers and educators, we cannot talk about or teach the concept of sustainability, unless we redesign the engineering education, focusing on gender equality and inclusivity for both the female academics and students of engineering education.

2 Sustainability, Gender Equality and COVID-19

For most of us, the first thoughts around sustainability and sustainable development are related to globalisation, climate change, energy and renewables, circular economy, food production and consumption, technology and digitalisation, engineering challenges, solutions and economic growth. However, very few of us realize that sustainability is linked to gender balance and will remain a theoretical, and almost a philosophical, challenge if we continue marginalising and discriminating more than half of the world’s population.

Sustainability and gender equality are the two sides of the same coin. Sustainable development relies on ending discrimination towards women, and providing equal opportunities for education and employment; gender equality is not only a fundamental human right, but a necessary foundation for a peaceful, prosperous and sustainable world. The United Nations have selected Gender Equality, as one of the United Nations

Sustainable Development Goals (UN SDG)^[8], highlighting the link between sustainability and gender equality.

Unfortunately, the effects of the COVID-19 pandemic have reversed the limited progress that has been made on gender equality and women's rights. The coronavirus outbreak exacerbated existing inequalities for women and girls across every aspect – from health and the economy, to security, social protection, paid work and equal opportunities^[8]. We have spent more than a year viewing and listening to men in podiums, proving that the decision making has been shifted again mainly to men, who represent less than half of the global population. The result is the lack of awareness and inclusiveness when it comes to essential decisions, which affect not only the female population, but also the younger generations. A very recent example of the disconnection of men from the real societal needs and solutions was the closure of the shoe shops for several months, resulting to several health and developmental issues of the Irish kids and teenagers. Shoes are an essential item in terms of the growth and development of children, but none of the male decision makers would understand or consider a fact as simple as this! This would have not been the case if women were equally represented in the decision making in relation to the pandemic.

Moreover, multiple studies have shown that COVID-19 have significantly affected the career development of women in academia. The use of lockdowns to attempt to mitigate the transmission of COVID-19 in communities increased the household and child-rearing demands of both men and women^[9]. Even without children, women still shoulder a greater share of domestic duties^[10]. A global study of academics found that this resulted in decreased time available to devote to research across the board; however, this was disproportionately experienced by women^[11]. More specifically, women have written significantly fewer papers than their male colleagues during the pandemic, with reports showing that at least one-third of working women in two-parent households exclusively provided child care after schools and day cares shuttered, resulting to a potential leak of the academic pipeline for many of them, due to the lack of support in career progression. The effect of COVID-19 to career development and progression is even worse for the females in engineering academia, because they are already working in a non-female friendly environment, dictated by male rules, prioritising male needs and defining success on male terms.

STEM fields are largely considered critical to national economies^[12] and studies have consistently shown that diverse teams are more productive and innovative^[13]. However, data compiled by the UNESCO Institute for Statistics in 2019 estimates that women represent 29.3% of the global research and development (R&D) workforce^[14]. The greater the number of women in leadership roles in a company, the better the company's economic performance and outcomes^[15]. Studies have found that teams with women have greater collective intelligence, which facilitates problem solving^[16], an essential skill in engineering. Therefore, to build a more sustainable world will need more female decision makers, such as engineers, academics, politicians, managers, entrepreneurs, professionals and leaders.

3 The “good girl” culture in engineering education

Unfortunately, there is still a strong culture around teaching girls to be “good”, unerringly nice, polite, modest, and selfless, embracing a version of selfhood that curtails sharply their personalities and potential. And it is this “good girl” culture that erects a psychological glass ceiling, which begins its destructive sprawl in girlhood and extends across the female life and career span, jeopardizing the growth of skills and habits essential to becoming a strong woman and a competent professional^[17].

The expectation, almost demand, to be “good girls” is even more toxic for the females working in male dominated sectors. A “good girl” who decides to pursue with a career in academia, and more specifically in the male dominated sector of engineering, has to be perfect. She has to be socially and academically successful, smart, pretty and kind. She has to work twice as much as her male colleagues but she does not have the right to complain, because she will come across as lazy. She has to please her colleagues, and students, to have no opinion and to follow the rules. She also has to earn less compared to her male counterparts, limiting the expression of her financial needs.

A female academic of engineering has to smile with inappropriate comments or jokes, to stay calm and be forgiving when her colleagues are doing “mistakes”, such as calling her “this thing”! She has to feel guilty when going on maternity leave; she actually has to work while on maternity leave, but her male colleagues are entitled to take credit for all her work during this time! She is on “maternity holidays” after all! She also has to accept that she cannot be the first or the last author of her articles, nor to submit a funding proposal under her name; she is the sailor, not the captain.

She cannot be ambitious; she does not have the right to think about career progression because her male colleagues are better than her. But if she does get promoted, this is because she is a woman, not because she deserves it.

Above all else, she must not question or rock the gender system. She must not draw attention to the difficulties, detriment, abuse and hurt this system perpetuates against women, or how it makes the fragile eco-system unsustainable for female engineer educators. Actually, she has to pretend not to be a woman, to conceal her highly gendered life experiences, in a gender blind system which assumes that the typical academic is white, male, middle class and without caring responsibilities.

A female academic in engineering education has to walk a treacherous line, balancing mixed messages about how far she should go and how strong she should be. She has to be enthusiastic while being quiet; smart with no opinions on things; intelligent but a follower; popular but quiet. She has to hold a second role, not to be the protagonist; she has to be something, but not too much.

4 Making engineering education sustainable

As mentioned earlier, building a more sustainable world will need more women engineers. Therefore, the presence of women in engineering education is essential, in order to be role models and inspire more girls – as well as boys – to study science and technology-based subjects and foster a new generation of technical professionals. In other words, it is essential to make the engineering education sustainable for female academics, prior to envisaging a sustainable world, designed by/with female engineers. The question is how to achieve this.

As engineers, we know that each problem has indeed multiple dimensions and therefore multiple solutions.

Actions to be taken:

- Women being able to call out systemic misogyny without fear of detriment to their career. The pandemic has raised levels of gender inequality to unsustainable levels; we can no longer afford, or morally condone a gender blind ‘eco-system’.

- The typical model of engineering educator and academic needs to be remodelled on a more diverse and inclusive demographic; it needs to take account of the different life experiences of women, black and ethnic minorities, LGBTQ+, disabled persons, and the social & economic disadvantaged.
- Equal pay and benefits for comparable roles and equal opportunities for progression and promotion.
- Equal consideration of needs and resourcing support. Specifically gender based needs, such as women's experience as mothers and other caring roles; institutional or state funded child care, improved and more flexible parental, caring and compassionate leave.
- Sustainable cultural changes in the academic workspace; zero tolerance of misogyny, sexual harassment, abuse, bullying or other forms of gender based violence in faculties.
- Male allies amongst engineering educators, this is not just a women's issue, and it is a societal problem.

5 Conclusions

The engineering education is indeed far from being sustainable for the female academics. Women in engineering education are not only under-represented; they are discriminated by academics, administrators and students, despite working harder. They are also earning less and are being inadequately represented in higher academic positions, being remote from the decision making tables, while they are expected to be “good girls” and sacrifice their career development, as a result of their family status and personal choices. There is nothing sustainable in this condition.

Female engineer educators and academics have reached a point where remaining silent and complying are no longer options. We cannot hold the baby any longer. The onus is on us all to call out misogyny, sexism and gender blind practice, structures, and support female academics who speak out about their experiences.

As engineers and educators, it is about time to practice what we preach and lead by example. We have no right to talk about or teach the concept of sustainability, if we do not change the culture and redesign the engineering education, focusing on gender equality and inclusiveness for the female academics of engineering and subsequently the future generations of engineers; this is the purpose of sustainability.

References

- ^[1] Perez C.C., *Invisible Women: Exposing data bias in a world designed for men*, vintage, London (2020).
- ^[2] O'Connell C. & McKinnon M, Perceptions of Barriers to Career Progression for Academic Women in STEM, *Societies* (2021) 11 (27): 1-20 (doi.org/10.3390/soc11020027)
- ^[3] Johnson-Bailey, J. & R. Cervero, Different Worlds and Divergent Paths: Academic Careers Defined by Race and Gender, *Harvard Educational Review* (2008) 78 (2): 311–332

- [4] Wenham C. , Smith J., Davies S. E., Feng H., Grépin K. A., Harman S., Herten-Crabb A. & Morgan R., Women are most affected by pandemics - lessons from past outbreaks, *Nature* (2020) 583 (8) 194-198 (<https://doi.org/10.1038/d41586-020-02006-z>)
- [5] Masterson V., Why COVID-19 could force millions of women to quit work - and how to support them, *World Economic Forum*, (2020) October (<https://www.weforum.org/agenda/2020/10/women-work-gender-equality-covid19/>)
- [6] Baker, N., One in 10 women quit jobs over pressure of juggling work and pandemic home life *Irish Examiner* (2021) April (<https://www.irishtimes.com/news/irish-examiner/one-in-10-women-quit-jobs-over-pressure-of-juggling-work-and-pandemic-home-life-1.4548444>)
- [7] Gabster B. P., van Daalen K., Dhatt R., & Barry M., Challenges for the female academic during the COVID-19 pandemic, *Lancet* 2020, 27 June-July; 395 (10242: 1968-1970; (doi: 10.1016/S0140-6736(20)31412-4) (<https://www.ncbi.nlm.nih.gov/pmc/articles/PMC7302767/>)
- [8] UN Sustainable Development Goals; (<https://www.un.org/sustainabledevelopment/gender-equality/>)
- [9] Mason, M.; Goulden, M. Do Babies Matter? The Effect of Family Formation on the Lifelong Careers of Academic Man and Women. *Academe* 2002, 88, 21–27.
- [10] Ruppner, L.; Tan, X.; Scarborough, W.; Landivar, L.C.; Collins, C. Shifting Inequalities? Parents' Sleep, Anxiety, and Calm during the COVID-19 Pandemic in Australia and the United States. *Men Masc.*, 2021.
- [11] Deryugina, T.; Shurchkov, O.; Stearns, J. COVID-19 Disruptions Disproportionately Affect Female Academics. In *COVID-19 Disruptions Disproportionately Affect Female Academics*; National Bureau of Economic Research: Cambridge, MA, USA 2021.
- [12] UNESCO. *Measuring Gender Equality in Science and Engineering: Working Paper 2 the Saga Toolkit Stem and Gender Advancement (Saga)*; UNESCO: Paris, France, 2017; pp. 1–87.
- [13] Malekjani, S. Culturally Diverse Women Need a Properly Designed System to Reach to Stemm Leadership Roles. 2017; (<https://womeninscienceaust.org/2017/08/07/culturally-diverse-women-need-a-properly-designed-system-to-reach-to-stemm-leadership-roles/>) (accessed on 2 February 2021).
- [14] UNESCO Institute for Statistics. *Women in Science*; UNESCO Institute for Statistics: Montreal, QC, Canada, 2019.
- [15] Schneider, J.; Eckl, V. The Difference Makes a Difference: Team Diversity and Innovation; *OECD Blue Sky*, 2016; (https://www.oecd.org/sti/015%20-%20SKY_Schneider_Eckl_201607025.pdf) (accessed on 24 February 2021).
- [16] Woolley, A.W.; Chabris, C.F.; Pentland, A.; Hashmi, N.; Malone, T.W. Evidence for a Collective Intelligence Factor in the Performance of Human Groups. *Science* 2010, 330, 686–688.
- [17] Simmons R., The Curse of the Good Girl, 2009; (<https://www.today.com/popculture/why-being-good-girl-can-be-bad-wbna32631120>)

**10th Conference on Engineering Education for Sustainable Development
(EESD2020)**

**A tool for introducing Social Life Cycle Assessment of products and
feedback from its users.**

Tatiana V. Vakhitova¹, Mike F. Ashby²

ANSYS Granta, Academic Relations Team

tatiana.vakhitova@ansys.com

Abstract

Product design involves the choice of materials, the processes used to shape them, transport modes, characteristics of the way the product is used and of its disposal at end of life. All of these influence the environmental impact of product life, now much studied using sophisticated (environmental) life-cycle assessment (E-LCA) tools. They also have social impacts that can be negative or positive contribute to either negative or positive social and environmental impact. The study of these is much more recent, stimulated initially by the UNEP / SETAC "Guidelines for Social Life Cycle Assessment (S-LCA) of Products" (UNEP/SETAC Guidelines) of 2009, and now gathering traction across the LCA community.

We have developed an Excel-based Social Impact Audit Tool (the Tool) following the UNEP / SETAC guidelines. Its primary aim is one of education, introducing students to the UNEP / SETAC methodology, providing data about social norms and practices in the Nations of the world, and allowing case studies for activity-based learning. The Tool flags social hotspots, highlighting the points in the life of a product at which potential harmful practices or opportunities to enhance well-being exist. The Tool is accompanied by a White Paper explaining its use and providing examples of its use. In a real world this type of analytics can be used, for instance, for CSR strategies on how to improve local conditions in locations in which a company operates.

The paper describes feedback from trialling the Tool at several universities, reporting on the expected and received learning outcomes; the ease of use and the clarity of the information provided; and how well the expectations were met.

1 Sustainable Development and Life Cycle Assessment

The UN report of 2015, "Transforming our World", introduced a set of Sustainable Development Goals to be achieved by 2030. It was supported by governments around the world. With 10 years to go, many of those goals will be missed. It is estimated that 430 million people will remain in extreme poverty by 2030 (Editorial, 2020), even though eliminating this was one of the goals. Similar failures are foreseen in meeting social and environmental goals. There are calls for greater focus on interlinkages of the goals and their synergies, instead of trade-offs among them (Kroll *et al*, 2019). Moreover, fit-for-purpose tools and mechanisms are required to encourage the gathering and monitoring of this kind of data (Ibid.).

Today's more established tools mainly focus on environmental impact assessment, such as LCAs, whereas social impacts are not well assessed and, therefore, synergies are not well-established (see Figure 1).

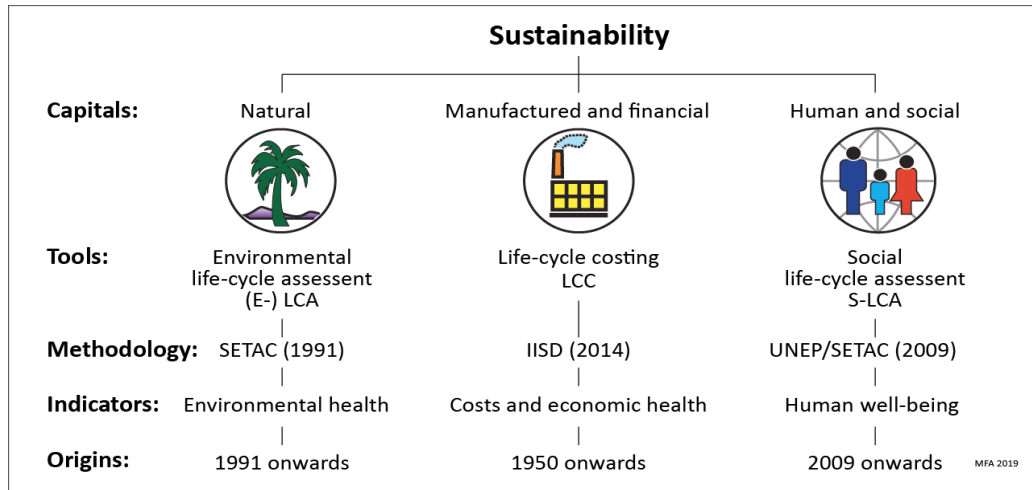

Figure 1. Life Cycle Assessment (LCA), Life Cycle Costing (LCC) and Social Life Cycle Assessment (S-LCA) (Ashby et al: 2019, 4).

Social life-cycle assessment (SLCA) has its roots in the Guidelines formulated in an UNEP/SETAC report over 10 years ago. It is currently undergoing revision under the UN Environment Life Cycle Initiative supported by the SLC Alliance to facilitate emerged diverse practices and applications with a more robust framework and guidance (Life Cycle Initiative 2020). Moreover, there is an identified industrial need for a reliable tool and accompanying data for integrating Sustainability in a Life Cycle Assessment process, which aids exploration of potential synergies among all pillars of sustainable development (Ibid).

However, a recent survey among educators involved in teaching sustainable development to engineers, designers and scientists at undergraduate and graduate level, with more than 200 respondents, showed that less than 30% address social impact in some form in their teaching (Vakhitova *et al*, 2015).

2 The Social Impact Audit Tool

The Social Impact Audit Tool (the Tool) (its detailed description is available in Ashby *et al*, 2019) is an attempt to support teaching of social impact during product life. The mission of the Tool is to provide a simple and visual overview of Social Hotspots in countries, where a product (or the material(s) from which it is made) has been produced, used or disposed. A Social Hotspot is identified as a “point of contact between stakeholders and aspects of the materials, manufacture, distribution and use of the product that may, potentially, be damaging or could be influenced in a positive way” (Ibid., 14). The Tool was trialled with students and faculty members, receiving positive feedback (see section 3).

The Tool is implemented in Excel, following the steps of UNEP/SETAC Guidelines for S-LCA, which parallels that established for Environmental LCA. It contains social and economic data for 205 countries, drawn from publicly available sources. Applying a threshold level of “good practice” reveals the countries and impact categories that fall below the threshold, acting as an indicator for further analysis. The tool provides a snapshot of potential social hotspots associated with the life of a product, but is limited to analysis at a National level, giving no insight into practice and the level of a specific enterprise.

From an educational perspective, the Tool provides an introduction to social life cycle assessment and as a gateway to further discussion about wider facets of sustainable development, analysis of Corporate Social Responsibility strategies and social investments. Ultimately the identified Social Hotspots could be used for directions of positive change for a product producing company, benefiting from access to human and environmental resources in countries of operations.

3 Feedback from trialling courses

The Tool was trialled in two universities in the USA during the last quarter of 2019: University of San Diego and PennState College of Engineering. On completion, the lecturers provided information on the following points:

- reactions of users on the value of the Tool,
- ease of use and clarity of the information provided to users, and
- changes or additional resources, which make it easier to introduce S-LCA to students.

At the University of San Diego, Dr Laura Gelles and Susan Lord incorporated the Tool into a Material Science course of a newly formed Department of Integrated Engineering, typically taken by engineering students. The Tool was introduced in a one-hour lecture plus a home assignment (~3 hours). A final assignment was used to assess the students' grasp of key ideas.

The learning objectives assigned to the course included: reflexion on environmental, economic, and social impacts when selecting a material and possible "recommendation for change of material and/or change of country of material origin, production, or end of life based upon the Social Impact Audit tool". The case study based around the use of a polypropylene drinking straws was used for analysis, suggesting alternatives such as paper, stainless steel, and bamboo. These provide triggers to unlock creativity and to stimulate development of strategies to reduce both the environmental and the social impact of their use, using the S-LCA tool as resource to support the second of these.

Professor Thomas Litzinger from the Institutes of Energy and the Environment (IEE) and Leonhard Center for the Enhancement of Engineering Education (USA) used a slightly modified version of the S-LCA tool in a workshop format. The modification combined the original data with "best/worst" actual values for the USA for impact category. Two one-hour workshops were performed. One with a group of top students and another one with a number of faculty members responsible for ABET-accreditation processes. Each workshop had contained a 15 min talk on Social Impact Audit Tool, following an introduction to an LCA and Social LCA. No explicit learning outcomes were set (it was a one-off exercise) but feedback was sought on the following questions:

- ease of use,
- perceived value (is it worth the time?),
- the case for including S-LCA studies in all Engineering and Computer Science programs, and
- the extent of learning about Social issues in other engineering courses in their program,
- if the Tool would be useful for meeting the new ABET "student outcomes", in particular, "the impact of engineering solutions in global, economic, environmental, and societal contexts" (2019, 3.4 and also in 3.2).

Some key conclusions emerged from both studies. There is a gap in teaching about the social impact of materials with similar results identified in the survey (Vakhitova *et al*, 2015). Students found the Tool easy to use and worth the small effort needed to learn how it operates. They report that the tool provided a good introduction to the social issues surrounding the life cycle of a product, stimulated discussion and provided important input to understanding the global impact of engineering. Participants shared a number of positive and motivational messages, stimulated by their use of the Tool. Some have mentioned that even just knowing about such tool/ratings helps to understand about a wider impact product has than those immediately apparent. And that this should make engineers and designers more considerate about designing with sustainability in mind, what would be also important for personal motivation and career aspirations. In the second case, it was decided to use the Tool in a future workshop for faculty members on how to meet the new ABET requirements.

Participants sought reassurance that the data would be regularly updated and requested more guidance in drawing conclusions and creating the final report. Some struggled to understand the normalised data and the hotspot-threshold. Others mistakenly added the number of hotspots to give a total, failing to understand that a hotspot is a flag for further research and possible action, not penalty-point for social misjustice. It seems that most students did not read the accompanying paper explaining how the Tool works. Neither group was explicitly asked to do any reading (e.g. accompanying White Paper) prior to being introduced to the Tool. A short video (5 -10 min), describing the Tool and the approach with a case study, would be helpful. This is now planned.

At a deeper level, the feedback highlighted the need for more help in using the Tool to guide decision-making. In particular, there is need for guidelines to promote discussion of the social responsibilities of companies operating in countries with identified Social Hotspots and the options available to these companies to ameliorate them. The complex interplay between economic, environmental and social factors is not, at present addressed; there is a clear need for resources to help teachers steer discussion of this central topic.

4 Conclusions

This paper describes feedback from trials of a new Excel-based Tool designed to introduce students to Social Life-cycle Assessment (S-LCA), following the UNEP / SETAC Guidelines. The Tool's key outcome is flagging "Social Hotspots" – the points in the life of a product at which potential harmful practices or opportunities to enhance well-being exist, based on an extensive set of socio-economic data.

Students found the Tool easy to use, worthwhile, and a stimulus for discussion of the social impacts of product life and the materials they contain. A number of challenges emerged. One is that of misunderstanding of the meaning of a Social Hotspot and the actions that follow when it is identified. This is unfamiliar territory of many engineering students, highlighting the need, for instance, for a short video support to provide the necessary background (reading material is not very popular). A second, is the need to place S-LCA in context of a broader life cycle assessment encompassing the environmental and economic, as well as the social, aspects of product life.

The trials form part of a strategy to develop GRANTA EduPack product as a resource to support the teaching of Sustainable Development. We are exploring ways in building the S-LCA tool into the existing

software in a way that is compatible with the present Eco Audit Tool for streamlined life cycle inventories that is one of its standard features. At the same time, we are developing material to run workshops, quizzes or microprojects to kick-off discussion around the topics that emerged as “needs” in the trials described here. We are actively working with collaborators to expand the Tool further and would welcome suggestions for its expansion and the directions in which it might be developed.

5 References

ABET Criteria for Accrediting Engineering Programs, 2019 – 2020

<https://www.abet.org/accreditation/accreditation-criteria/criteria-for-accrediting-engineering-programs-2019-2020/#GC3>

Ashby, M., Brechbühl, E., Vakhitova, T. and Vallejo, A. 2019, *White Paper: Social Life-Cycle Assessment and Social Impact Audit Tool*. <https://grantadesign.com/teachingresources/papslcn19/>

ASM Medical Materials Database (2020) ASM International, Materials Park, OH 44073-0002

Editorial. 2020. Get the Sustainable Development Goals back on track. *Nature*, 577, 7-8.

<https://www.nature.com/articles/d41586-019-03907-4>

Kroll, C., Warchold, A. & Pradhan, P. 2019. Sustainable Development Goals (SDGs): Are we successful in turning trade-offs into synergies? *Palgrave Commun* 5, 140. <https://doi.org/10.1057/s41599-019-0335-5>

Life Cycle Initiative, Consultation on S-LCA Guidelines, 2020

<https://www.lifecycleinitiative.org/consultation-on-s-lca-guidelines-now-open/>

United Nations. 2015. *Transforming our World: The 2030 Agenda for Sustainable Development*.

<https://sustainabledevelopment.un.org/post2015/transformingourworld/publication>

United Nations Environment Programme. 2009. *The Guidelines for Social Life Cycle Assessment of Products* http://www.unep.fr/shared/publications/pdf/dtix1164xpa-guidelines_slca.pdf

Vakhitova, T., Shercliff H., Ashby, M., 2015, Taking Stock: Sustainability in Engineering Teaching; case of CES EduPack – software for academics, Proceedings EESD 2015.

<https://open.library.ubc.ca/cIRcle/collections/52657/items/1.0064736>

Teaching Sustainable Design through Simultaneous Evaluation of Economics and Environmental Impacts

Kirti M. Yenkie^{1*}, John D. Chea¹, Emmanuel A. Aboagye¹, Mariano J. Savelski¹, and C. Stewart Slater¹

¹Department of Chemical Engineering, Henry M. Rowan College of Engineering, Rowan University, Glassboro, New Jersey, USA.

yenkie@rowan.edu

Abstract

The ever-increasing human population and industrial growth have posed a considerable burden on existing resources and have led to an increase in environmental pollution and climate change. The Engineering Clinics offered at the Henry M. Rowan College of Engineering at Rowan University is the hallmark of our program that enables our undergraduate students to actively participate in solving real-world problems through collaborative activities. Our graduate students get an opportunity to engage in stakeholder (*i.e.*, industries, federal and regional funding agencies) interactions and student mentoring in conjunction with developing their research ability. Thus, through these synergistic undergraduate-graduate-faculty-stakeholder collaborations this work envisions to develop awareness about sustainable design and environmental impact in the community. The clinic problems include; (i) solvent recovery in process industries, and (ii) systematic synthesis of wastewater treatment (WWT) networks. These problems are important because imprudent use of industrial solvents and water resources have exacerbated the challenges relating to availability, quality as well as safe disposal of harmful solvents and wastewater. Through these challenging and relevant problems, we can teach our students multiple skills such as information collection, selective extraction of valuable content, economic and sustainability evaluation of multiple pathways through mathematical modeling, computer programming, technical writing, and presentation. The overall impact of these efforts is evident in the peer-reviewed conference and journal publications, oral and poster presentations at regional and national conferences, as well as our students choosing careers which value sustainability.

1 Introduction

The unique feature of the undergraduate curriculum at the Henry M. Rowan College of Engineering (HMRCOE) at Rowan University (RU) is the Engineering Clinics, which are offered in conjunction with all the required courses every semester. The undergraduate students from all the engineering disciplines are part of a common clinic activity in their first two years, which are aimed at enhancing the basic engineering skills and to increase an aptitude for reason-based learning. They also learn basic technical writing and presentation skills in these two years. In their junior (3rd) and senior (4th) years, these students get an opportunity to participate in discipline-specific research-based clinics where they have an opportunity to engage with stakeholders from industries and federal agencies and work on real-world problems. In this paper, we have placed an emphasis on one specific clinic project: solvent recovery in process industries. This project is offered in the Chemical Engineering department at RU to teach our students the importance of sustainable design and the impacts of chemical processes and their effluents on the environment. In the following sub-sections, the background and motivation in choosing this clinic project are emphasized.

1.1 Solvent Recovery and Reuse

The demand for solvents has expanded across many industries such as the pharmaceutical, adhesives, food, cosmetics, cleaning, and personal care industries. Solvents are typically used as dissolution medium, materials to aid in reaction, mass separation, and cleaning operations (Slater et al., 2010; Wypych, 2014). However, there are inefficiencies in the existing industrial manufacturing processes, which can be caused by large-scale production challenges such as inefficient mixing, insufficient reaction time, inappropriate technologies, quality of raw materials, measurement control anomalies, etc. (Cavanagh et al., 2014a; Raymond et al., 2010). The global chemical market is projected to double between 2017 and 2030. However, waste generation due to poor solvent selection and processing inefficiencies in the chemical industry have led to a growing concern for chemical releases, exposures, environmental impacts, and health safety (United Nations Environment Programme, 2019). The US EPA has estimated that solvent emissions resulting from the chemical market growth can reach up to 10 million metric tons of carbon dioxide equivalent (US EPA, 2016, p. 2).

1.2 Role of Process Systems Engineering (PSE)

The selection of appropriate solvent recovery technologies is a function of the physicochemical properties of solvents, other components present in the waste stream, and the desired final purity levels to be achieved after separation. These separation technology options may include sedimentation, filtration, precipitation, distillation, liquid-liquid extraction, and pervaporation (Chea et al., 2019). Hence, this problem belongs to the process systems engineering (PSE) area, which comprises multiple methods and their associated computational tools to systematically solve the problem of generation of solvent recovery framework.

Furthermore, the availability of multiple recovery technologies, such as distillation, pervaporation, and aqueous two-phase extraction, adds complexity to the selection process. A comparative assessment of the solvent recovery methods to the existing waste handling methods such as incineration is crucial to change the mindset of the people working in process industries as well as our undergraduates, who are the future workforce of the nation. Through PSE tools, we can selectively choose appropriate materials/methods for the efficient design of treatment systems and their sustainability over the desired period. Through planned projects, educational activities, and result dissemination, we aim to create an appreciation for ‘Sustainable Design in Engineering’ and motivate students to pursue it as their career path.

2 Methodology

2.1 Project Teams & Management

The clinic project team is composed of 2-3 undergraduate students, a graduate student mentor, and faculty advisors. The faculty develops contact with industries and other universities, applies for research and educational grants to federal and regional agencies, and private funding organizations. The faculty is responsible for developing the project goals and learning objectives for the students. The graduate student mentor is responsible for ensuring the project continuity, documentation, and partial supervision of undergraduate students. The engineering clinic is a 2-credit course every semester with biweekly meeting slots of 3 hours each. This course provides ample time for required student training, progress assessment as well as consultations with industrial liaisons and collaborators.

2.2 Tutorials for Basic Research Skills

As faculties, we provide students initial training on the necessary research tools and resources. The most crucial aspect for both these clinic projects was a literature review to collect relevant information about existing industrial processes and their waste streams, characterization metrics, existing case studies, technology information, and modelling. To this end, the students were trained to use literature review resources such as Google Scholar, and SciFinder Scholar. Instructions were provided on reading research papers effectively as well as categorizing them into reviews, model information, case studies, optimization, and simulations. Furthermore, they were trained to use citation managers such as Zotero and Mendeley to create a systematic database of references and cite them in research reports and manuscripts.

The next set of tutorials included training in PSE tools for mathematical modelling and optimization. Since both, the clinic projects involve a selection decision between multiple waste treatment and resource recovery technologies to meet the cost criteria and minimization of overall environmental impacts, the optimization tools needed were non-linear programming as well as discrete programming (Biegler et al., 1997; Diwekar, 2013). The theory, as well as software training in Matlab, GAMS, and P-graph (Heckl, Friedler, and Fan 2010), were provided to the students. Training for the environmental impact assessment tools such as SimaPro (Cavanagh et al., 2014b) and Sustainable Process Index (Narodoslawsky and Krotscheck, 1995) were also provided. Additionally, resources for enhanced technical writing and presentation skills were taught. These tutorials were scheduled appropriately as per the project's progress and requirements. Figure 1 highlights the resources and tools from PSE that our research lab (the Sustainable Design & Systems Medicine Lab) has access to at Rowan University.

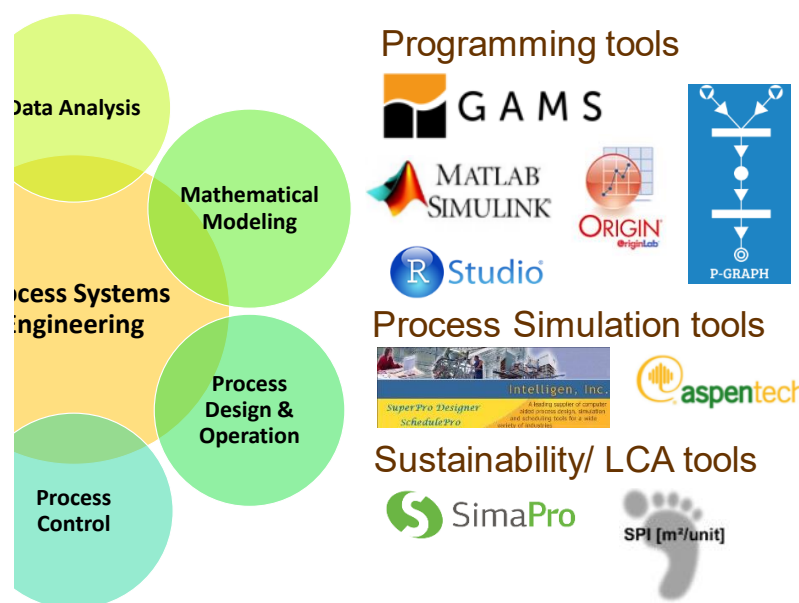

Figure 1: Process Systems Engineering (PSE) tools and computational resources at the Sustainable Design & Systems Medicine Laboratory at Rowan University.

2.3 Clinic Project; Solvent Recovery in Process Industries

This clinic project is funded by the US Environmental Protection Agency's Pollution Prevention Program. It addresses the two important national emphasis areas of (1) Business-based pollution prevention solutions

supporting the Toxic Substances Control Act (TSCA) Priorities and (2) Hazardous materials source reduction approaches in States or Communities. The overall goal of this project is to develop a computational software tool that can help the chemical industry minimize solvent waste from chemical processes. The research strategy for the proposed project has been divided into the following specific aims:

- Aim#1: Collect information and consult industries about solvent recovery issues in current practices
- Aim#2: Create a list of potential solvent recovery technologies based on information collected about solvent applicability, toxicity, and physicochemical properties.
- Aim#3: Develop technology models comprising of mathematical equations involving material and energy balances, utility (electricity, cooling water) requirements, equipment design, and costing
- Aim#4: Based on properties of the solvent rich stream, devise a ranked list of the best recovery pathway which minimizes cost, reduces environmental impact, and limits the waste discharge
- Aim#5: Develop a user-friendly computer-aided software program for the solvent recovery roadmap

An example case study from the pharmaceutical industry is analysed, and the results are explained in section#3.

3 Results

3.1 Economic Evaluation of IPA Recovery from Pharmaceutical Waste Stream

Pfizer and Rowan University had carried out an investigation with aims to recover and purify isopropanol (IPA) and minimize waste from the celecoxib process, which produces the API for an arthritis pain medicine known as Celebrex® (Slater et al., 2012). The waste stream following the final purification stage contains a significant amount of IPA. However, the results of laboratory-scale distillation and extraction conducted at the plant site failed to reach the purity requirement (Slater et al., 2012). The case study is a classic representation of an API purification process. In a batch process, the celecoxib process required 4,205 kg of IPA/batch. If incineration is selected as the waste solvent disposal method, then approximately 14.51 kg of steam and 0.83 kWh of electricity/kg IPA is required. Life cycle analysis (LCA) has determined that there is 2.19 kg of total emission/kg of IPA used within the process (Slater et al., 2012).

Azeotropic points are anticipated at 87.7 wt.% and 80.37°C, which means that separation solely through distillation will not be able to achieve the desired purity. A summary of IPA recovery model specifications is provided in Table 1, where we assumed a waste stream feed basis of 1000 kg/hr.

Table 1: Isopropyl Alcohol (IPA) recovery case study model specification for optimization

Feed Conditions	Feed Rates (kg/hr)	Outlet Requirements (%)
IPA 51%	510	Recovery: 99.5% IPA
Water 49%	490	Purity 99%

The general equations for process streams, costs, energy requirements, and theories concerning technologies are composed of linear and non-linear equations. The selection or non-selection is represented via binary variables in the superstructure. This example is formulated as a mixed-integer non-linear programming (MINLP) problem and solved in the GAMS programming language through Branch-and-

Reduce Optimization Navigator (BARON) algorithm. Although solvent recovery is inherently a multi-stakeholder problem, we concentrated our objective toward only cost minimization. The optimized path is presented in Figure 2, with an annualized cost of \$524,000 (i.e., 14 cents/kg solvent recovered) over 25 years (Chea et al., 2020). This pathway was able to reach the desired output specification from Table 1 and presents a solution with the lowest potential cost in comparison to other alternative pathways. Figure 2B presents the cost distribution of the optimal pathway. The annualized capital cost accounts for up to 47% of the total costs of the optimal pathway, followed by other costs (overhead), membrane replacement, labor, and utility. The price of selecting this pathway may be reduced further if the pervaporation and ultrafiltration units are available onsite for retrofit.

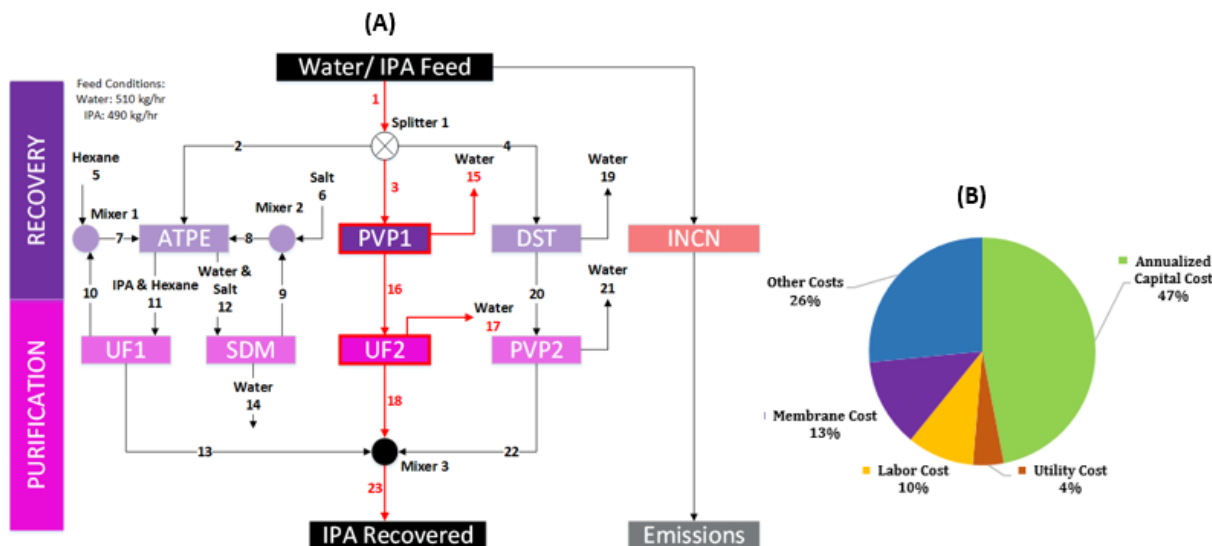

Figure 2: (A) A superstructure of the possible solvent recovery methods to separate IPA from the water. ATPE, UF, SDM, PVP, DST, and INCN represent aqueous two-phase extraction, ultrafiltration, sedimentation, pervaporation, distillation, and incineration, respectively. The most economically viable pathway for IPA recovery is highlighted in red. (B) The cost distribution of the optimal pathway (PVP1—UF2).

In comparison to incineration, solvent recovery is more economically viable. The cost required to incinerate the hypothetical waste flow rate of 1000 kg/hr requires \$8.1 million/yr., which equates to \$2.01/kg incinerated. The considerable increase in cost is attributed to the requirement for the heat of combustion. The organic solvent's chemical identity is irreversibly altered and thus cannot be reused within the process.

3.2 Environmental Impacts Assessment of IPA Recovery from Pharmaceutical Waste Stream

The environmental impacts of the optimized solvent recovery pathway were compared against conventional waste disposal methods. Sustainable process index (SPI) is an ecological footprint that measures the total arable area needed to embed a process into the ecosystem. SPI quantifies the environmental impacts of goods and services using material and energy flows. The primary assumption on which SPI is built on is that the natural source of environmental income to a sustainable economy is solar energy or radiation. Since the planet is finite, the area available to convert this income (solar radiation) into products and services is also finite. Therefore, the arable area needed to provide a service or goods is a convenient measure for the

SPI from an ecological sustainability point of view. Higher arable area needed to provide service goods corresponds to the increased impact on the ecosystem (Krotscheck and Narodoslowsky, 1996; Narodoslowsky, 2015; Narodoslowsky and Krotscheck, 1995, 2004). Human activities exert pressure on the ecosystem. To build up a process, humans depend on the ecosystem for resources such as both renewable and non-renewable energy, installation of equipment, and extraction of raw materials. Emissions are generated after the production of a product from a process. Therefore, an area in the ecosystem is needed to embed these air, water, and soil emissions aside from the areas needed for resource generation. The summation of these individual areas gives the total arable area needed to provide one unit of a product. Figure 3 shows the schematics for SPI.

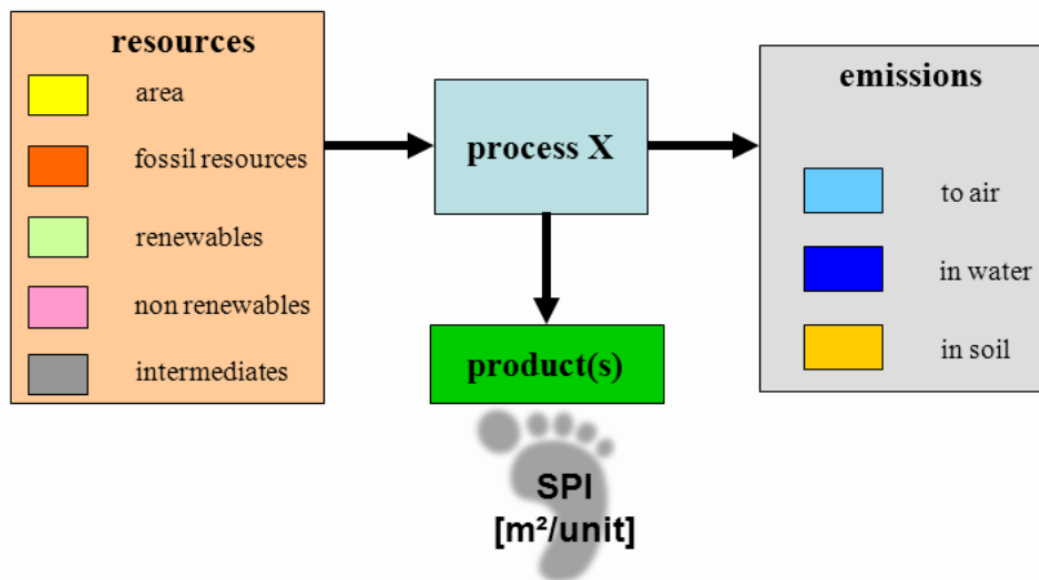

Figure 3. Schematics for sustainable process index. The resources are the inputs (quantified as arable area) to the process. Every process produces some emissions in the form of air, water, and soil. These emissions need to be embedded within an area in the ecosystem. The summation of these individual areas per unit of product(s) produced gives the SPI value.

The sustainability analysis for this case study was modelled using the sustainable process index footprint in SPIonWeb – an open-source software. For environmental impacts comparison, we considered three case scenarios, which include solvent recovery, direct disposal of the solvent waste into the environments, and incineration of the solvent waste. Table 2 shows the results for the case study from SPI analysis.

Table 2: Annual arable area (from SPI) needed to provide the services of direct disposal, solvent recovery, and incineration and the CO₂ emissions and global warming potential associated with these services.

	SPI (m ² .a/unit)	SPI (m ² .a/yr.)	CO ₂ (kg/yr.)	Global Warming Potential (kg CO ₂ -eq/yr.)
Direct Disposal	1988	8.03E+09	2.03E+07	2.17E+07
Solvent Recovery	128	4.93E+08	1.60E+06	1.69E+06
Incineration	405	3.21E+09	1.57E+07	1.71E+07

The total arable area needed for direct disposal and incineration supersedes that of solvent recovery by 93.9% and 84.6%, respectively. Thus, it will cost the ecosystem, an extra 93.9%, and 84.6% of natural income (arable area) if direct disposal and incineration were selected as the method of waste disposal. The annual CO₂ emission and global warming potential for both direct disposal and incineration supersede solvent recovery by 92.2% and 89.2%. Therefore, in all three scenarios, solvent recovery provides the best option for the treatment of hazardous waste.

Currently, we have completed the assessment of the economic and environmental impact separately, with greater emphasis on economics. If the cost of solvent recovery processes exceeds the price of common waste disposal methods significantly, then there is little incentive to choose recovery. Depending on the values of the company, more expensive recovery options may be chosen to minimize the overall environmental impacts. The next step in this work involves integrating this multi-objective complexity through the simultaneous modelling of both objectives using GAMS.

4 Summary

Through our unique engineering clinic program as well as synergistic efforts of the students, faculty, and staff at Rowan University, we were able to teach our students the importance of Sustainable Design in Chemical Engineering. In addition to project-based technical skills, the students also learned the importance of teamwork, technical writing, and presentation. Our students have presented this work at the AIChE (American Institute of Chemical Engineers) regional and national meetings, and in this process, they gained networking and communication skills. We believe that as engineering educators, it is our responsibility to teach the students the impact of systems-inspired design. Through all these activities, we were able to achieve our goals.

Acknowledgments

This research was supported by the United States Environmental Protection Agency's Pollution Prevention (P2) Program (NP96259218-0). The Design Engineering approach to education has been supported by an internal KEEN Curricular Reimagination Grant.

References

- Biegler, L.T., Grossmann, I.E., Westerberg, A.W., 1997. Systematic methods of chemical process design. Prentice Hall PTR.
- Cavanagh, E.J., Savelski, M.J., Slater, C.S., 2014a. Optimization of environmental impact reduction and economic feasibility of solvent waste recovery using a new software tool. *Chemical Engineering Research and Design* 92, 1942–1954. <https://doi.org/10.1016/j.cherd.2014.02.022>
- Cavanagh, E.J., Savelski, M.J., Slater, C.S., 2014b. Optimization of environmental impact reduction and economic feasibility of solvent waste recovery using a new software tool. *Chemical Engineering Research and Design, Green Processes and Eco-technologies* 92, 1942–1954. <https://doi.org/10.1016/j.cherd.2014.02.022>
- Chea, J., Lehr, A., Stengel, J., Savelski, M.J., Slater, C.S., Yenkie, K., 2020. Evaluation of Solvent Recovery Options for Economic Feasibility through a Superstructure-Based Optimization

- Framework. *Industrial & Engineering Chemistry Research*.
<https://doi.org/10.1021/acs.iecr.9b06725>
- Chea, J.D., Christon, A., Pierce, V., Reilly, J.H., Russ, M., Savelski, M., Slater, C.S., Yenkie, K.M., 2019. Framework for Solvent Recovery, Reuse, and Recycling In Industries, in: Muñoz, S.G., Laird, C.D., Realf, M.J. (Eds.), *Computer Aided Chemical Engineering, Proceedings of the 9 International Conference on Foundations of Computer-Aided Process Design*. Elsevier, pp. 199–204.
<https://doi.org/10.1016/B978-0-12-818597-1.50032-1>
- Diwekar, U., 2013. *Introduction to Applied Optimization*. Springer Science & Business Media.
- Krotscheck, C., Narodoslowsky, M., 1996. The Sustainable Process Index a new dimension in ecological evaluation. *Ecological Engineering* 6, 241–258. [https://doi.org/10.1016/0925-8574\(95\)00060-7](https://doi.org/10.1016/0925-8574(95)00060-7)
- Narodoslowsky, M., 2015. Chapter 3 - Sustainable process index, in: Klemeš, J.J. (Ed.), *Assessing and Measuring Environmental Impact and Sustainability*. Butterworth-Heinemann, Oxford, pp. 73–86.
<https://doi.org/10.1016/B978-0-12-799968-5.00003-8>
- Narodoslowsky, M., Krotscheck, C., 1995. The sustainable process index (SPI): evaluating processes according to environmental compatibility. *Journal of Hazardous Materials, Selected papers presented at the Conference on Hazardous Waste Remediation* 41, 383–397.
[https://doi.org/10.1016/0304-3894\(94\)00114-V](https://doi.org/10.1016/0304-3894(94)00114-V)
- Narodoslowsky, M., Krotscheck, Ch., 2004. What can we learn from ecological valuation of processes with the sustainable process index (SPI) — the case study of energy production systems. *Journal of Cleaner Production, Advances in cleaner production technologies* 12, 111–115.
[https://doi.org/10.1016/S0959-6526\(02\)00184-1](https://doi.org/10.1016/S0959-6526(02)00184-1)
- Raymond, M.J., Slater, C.S., Savelski, M.J., 2010. LCA approach to the analysis of solvent waste issues in the pharmaceutical industry. *Green Chemistry* 12, 1826. <https://doi.org/10.1039/c003666h>
- Slater, C.S., Savelski, M., Hounsell, G., Pilipauskas, D., Urbanski, F., 2012. Green design alternatives for isopropanol recovery in the celecoxib process. *Clean Technologies and Environmental Policy* 14, 687–698. <https://doi.org/10.1007/s10098-011-0433-6>
- Slater, C.S., Savelski, M.J., Carole, W.A., Constable, D.J.C., 2010. Solvent Use and Waste Issues, in: Dunn, P.J., Wells, A.S., Williams, M.T. (Eds.), *Green Chemistry in the Pharmaceutical Industry*. Wiley-VCH Verlag GmbH & Co. KGaA, Weinheim, Germany, pp. 49–82.
<https://doi.org/10.1002/9783527629688.ch3>
- United Nations Environment Programme, 2019. *Global Chemicals Outlook II - From Legacies to Innovative Solutions - Synthesis Report (2019)*, Global Chemicals Outlook II. United Nations Environment Programme.
- US EPA, O., 2016. *Global Mitigation of Non-CO2 Greenhouse Gases: Solvents [WWW Document]*. US EPA. URL <https://www.epa.gov/global-mitigation-non-co2-greenhouse-gases/global-mitigation-non-co2-greenhouse-gases-solvents> (accessed 3.3.19).
- Wypych, G., 2014. 13 - Solvent Use In Various Industries. Oxford: ChemTech Publishing, *Handbook of Solvents* 1–261.

Sustainable Engineering Management for International Development: lessons learned from a new and interdisciplinary MSc programme

Xiaojun Yin¹, Krijn Peters², Patricia Xavier¹ and James Holness¹

¹College of Engineering, Swansea University, UK

²College of Arts and Humanities, Swansea University, UK

x.yin@swansea.ac.uk

Abstract

Swansea University has developed a Sustainable Engineering Management in International Development Masters course which attempts to pave the way for a new brand of ‘global’ engineers equipped with core engineering skills, complemented by understanding of how engineering both affects and is affected by environmental and social factors/dimensions. Stepping outside of the traditional academic delivery box, the course enrolls students with different backgrounds and experiences, with an equal balance of engineers and non-engineers taking theoretical modules, each delivered intensively over a two-week period and structured around real-life projects. The curriculum is centred around transdisciplinary learning using a project-based learning approach with year-long projects in development contexts, following key principles of global service learning. This paper explores the first three years of course delivery, through the lenses of four academics involved in course conception, curriculum design, delivery and development, each from the different perspectives of social science, internationalisation, engineering education and engineering practice.

Introduction

There has long been a recognition that the traditional curriculum is no longer effective in preparing students to overcome complex and intractable problems (Forster *et al.*, 2017). For contemporary development collaboration or interventions, a group of Swansea University academics who worked together on a multidisciplinary research project in international development felt strongly that there is a need for a new brand of ‘global’ engineers in sustainable practice and that engineering education needs to equip students with core engineering skills which are complemented by an understanding of how engineering both affects and is affected by environmental and social contexts. This need led to stepping outside of the traditional higher education box to give ‘birth’ to a Master of Science (MSc) course in Sustainable Engineering Management for International Development (SEM4ID).

The SEM4ID MSc curriculum is oriented around global service learning (GSL) projects, using a project-based-learning (PBL) pedagogical approach (Blumenfeld *et al.*, 1991), with key skills developed and/or strengthened through project delivery and transdisciplinary learning, whilst working in a specific (overseas) community context. As well as undertaking inductive needs assessments, design and delivery management of an appropriate engineering intervention, students have responsibilities to manage their relationships with the community and the stakeholders, identify how best to apply their skill sets and work effectively in a multidisciplinary team. The field work supported by theoretical teaching delivered by the College of Engineering (CoE), the College of Arts and Humanities (CoAH), School of Management (SoM) and external practitioners, is designed to prepare students to function sensitively in foreign cultures, develop and act on the whole-problem definition. The students work to

transfer ideas into engineering solutions, critically evaluate the appropriateness of technological applications for a given social and economic context and monitor and evaluate the impact of projects.

Whilst the potential benefits for learning and skills development through GSL using PBL has been well documented, the delivery of a mastered course centred around GSL presents huge challenges, from course approval to logistic organisation to operating ethically in the field to effective partnering with the community. A number of barriers had to be overcome to start the SEM4ID MSc and the course continues to face different challenges with each cohort/project cycle.

This paper reflects on the first three years of programme delivery from the perspective of four academics who developed and currently run the SEM4ID MSc course, each from the different disciplinary viewpoint of social science, internationalisation, engineering education and engineering practice.

Dean of Internationalisation: stepping outside of the traditional academic box

The SEM4ID MSc programme is a result of a transdisciplinary research collaboration between social science academics within CoAH and several engineering academics within the CoE at Swansea University. This group was previously engaged in multidisciplinary research work related to various aspects of improved access through rural motorcycle taxi track development in Liberia. As a further development of this research, the academics supervised a group of Master of Engineering (MEng) students to work specifically on a project to design a motorcycle trailer, building and testing it in-situ. Even though the initial design produced in Swansea was functional, when the local motorcycle riders tested it in Liberia, they decided it was not usable. The students revisited the design assumptions using feedback from the local riders and embarked upon a 'human centred' design process in the field, to develop prototypes which were more acceptable (Brown *et al.*, 2015).

It was clear to the supporting academics that the experience had been of incredible value to the professional development of these young student engineers, having gained first-hand experience of fundamental engineering practise through the field-based project. More importantly still, this experience was gained in a very different environment and amongst a different culture to that which they were familiar. Critically, the students had realised the important role of the end user, through community engagement. During the final debrief, one student stated that he felt he had learnt more in the one-week field trip than in the last year of his degree.

After reflection and significant liaison between the supporting members of staff who had accompanied the student team into the field, the idea of developing an MSc degree that centred around experiential learning evolved. The idea was to blend social science tools with fundamental engineering and project management principles through PBL in development contexts. The aim was to recruit students from any background to form well balanced (including gender balanced) project teams consisting of engineering, social science and other non-engineering graduates and/or practitioners, to further scaffold knowledge through interdisciplinary peer to peer learning. The aim of the curriculum was to equip graduates from any background with the ability to navigate around complex projects, to develop a holistic approach towards problem solving and be able to manage engineering interventions in different development contexts sustainably.

It was quickly realised that the diversity in the teaching and support team required would go beyond that of the existing academic cohort within Swansea University. To allow for teaching contribution from experienced practitioners and external consultants, essential for the delivery of this course, and to have the flexibility in timetabling to accommodate for the necessary field trips, the programme delivery is designed around short intensive two-week modules, rather than term-long ones. The curriculum is

structured to develop knowledge and skills in timely steps in preparation for project work and field trips.

The governance process meant that the programme had to be approved by key committees within Swansea University. All of these groups could see the value in the programme. However, there have been concerns over the risks associated with the field-based elements, the cost of running such a programme and the burden on support staff, given the “depth of engagement” essential in running a course like this. Course specific mitigation strategies had to be put in place before the course was finally approved. The course currently requires funding (albeit progressively reducing) in addition to what is available from student fees, which is a threat to its long-term survival.

Now in its third year, the SEM4ID MSc delivery format still faces institutional challenges in course organisation, timetabling and logistics, due to it being very different from the traditional courses, which the university is experienced in delivering. Accreditation by the Engineering Council with a licensed engineering institution also presents challenges, as the course assessments do not include any formal exams and is based 100% on coursework. Also, the core learning through the project work is carried out by multidisciplinary teams of engineers from various disciplines as well as non-engineers and it is more of an administrative challenge to directly verify individual learning outcomes aligning with requirements for the Accreditation of Higher Education Programmes (AHEP).

The social scientist: a sustainable international development perspective

These days development takes place via partnerships, something that is recognized by the Sustainable Development Goals and its predecessor, the Millennium Development Goals. The development jargon talks about: ‘inclusiveness’; ‘pro-poor’; ‘gender-awareness/sensitive’; ‘empowerment’; ‘participation’; ‘community-driven’; ‘knowledge co-production’, ‘good governance’ etc. While these terms often lack clear and agreed definitions – some terms are both a ‘means to achieve a goal’ and an ‘end-goal’ in itself – it provides a framework to critically assess a project cycle or technological intervention from its conceptualisation, to feasibility, design, production, use and monitoring and evaluation stages. Furthermore, contemporary development collaboration or interventions – even those that are engineering heavy - require a multidisciplinary approach, with engineers working together with social scientists (eg. gender specialists, anthropologists, economists, political scientists, etc.) and scientists (eg. biologists, geographers, health experts, etc). Old fashion ‘box or discipline’ thinking no longer suffices. A case in point is the rural road-construction in developing countries – once the exclusive domain of engineers. The project described below sowed the initial seed which led to the development of SEM4ID.

In Liberia, the Ministry of Public Works (MPW) requires feeder roads (typically low volume roads which connect to the country’s primary road-network) to be constructed or rehabilitated according to international standards to be at least 5 metres wide and with water-crossings able to accommodate up to 40 tonnes, resulting in expensive and arguably over designed structures. For war and ebola affected Liberia, mobility and access is vital, in particular for semi-subsistence farmers who tend to be among the poorest of the poor. While MPW’s strategy seems to be a sensible one, it does not acknowledge the rapid changes that have taken place in mobility in Liberia (and for that matter, across sub-Saharan Africa). Where before most if not all motorised transport in rural areas took place by conventional vehicles (shared taxis, pick-up trucks, mini-buses, etc.), nowadays the majority of passenger and goods transport takes place by motorcycle taxi. Our intervention (Jenkins & Peters, 2016) took this rapid – and market driven - change in the means of transport as the starting point, and proposed a new type of road infrastructure: upgrading rural footpaths (between farmstead and village and between village and roadside) to motorcycle taxi accessible tracks and assessing the socio-economic impact of this intervention. Through the creation of (gender-balanced) community-based organisations, the planning,

organisation, construction and maintenance of these local labour and local materials intensive interventions were firmly put into the hands of the beneficiaries. Our study found that the economic impact - mainly by making it possible for farmers to bring agricultural produce to markets using motorcycle taxis rather than having to head-load, allowing for a larger volume to be monetised - and benefits following improved access to education and health facilities were significant and value for money (Peters *et al.*, 2018).

Motorcycles are generally characterised as intermediate forms of transport and associated developments such the trailer to increase payload, designed by Swansea University MEng students are considered as intermediate technology. However, to label something as ‘intermediate’ may reflect Rostow’s ‘linear-stage’ thinking (Todaro, 2000). A more appropriate and contemporary term is ‘appropriate’ technology or innovation, acknowledging the context specific availability of resources/commodities and the need to use human ingenuity rather than blue-print thinking. Appropriate innovation and technology, sometimes described as ‘frugal innovation’ (Leliveld & Knorringa, 2018), aims to do more with less and is generally compatible with the three pillars of sustainability: social, economic and environmental, or at least considerably more than conventional resource-intensive innovations.

The focus for the SEM4ID MSc course is for students to deliver projects with technology or engineering elements which are ‘appropriate’ for the setting, paying due attention to the limited resources of the community where it is based. A solution may require the engineering technology involved to be basic/frugal, but the key value is in the process of verifying appropriateness through genuine interdisciplinary teamwork and co-production. For instance, while the structure for a chicken manure fertilizer compost drum, designed by one of the SEM4ID project teams was basically no more than a welded frame with rollers and a crank-arm, some of the challenges the student group were confronted with (and collectively had to find solutions to) when constructing it included: 1) The non-availability of the main organic input (chicken manure) due to the unforeseen closing down of a chicken farm, exemplifying the high uncertainty in availability of inputs due to rapid economic changes. 2) Challenges in working with local students due to culturally induced miscommunications/misunderstandings and different expectations associated with hierarchical structures. 3) Logistical challenges resulting from budgetary uncertainties, reflecting uncertain and volatile environments for operation and; 4) Mitigating varying perceptions of attitudes to safety and risks, in a context where bricklayers may wear flip-flops and welders use sunglasses. Rather than just delivering the appropriate innovation’s hardware (eg. the compost tumbler), finding solutions to these hybrid (engineering, social, economic, cultural, etc.) problems and challenges – together with local students and local project participants – is the real contribution our GSL projects made.

The engineering education perspective: developing an integrative pedagogy to rehabilitate engineering students into engaging with social context

The course structure was developed to mix and match engineering and social science taught content and methodologies in order to combine action-orientated engineering problem solving with more inductive approaches to facilitate more equitable working in partnership. Students and staff from engineering have found this transdisciplinary shift more challenging than the social scientists involved, and the pedagogy adopted in the course has had to shift over time to accommodate this. Rather than a simple merging of skillsets between the two disciplines, engineering students have often struggled with being confronted with the inadequacy of their academic engineering training in preparing them to work with real people on a project that could have positive and/or negative consequences for vulnerable communities. Instead of ‘topping-up’ their knowledge with extra skills, it seems to involve a re-creation of their own conception of engineering and engineers. There are complex social and financial

relationships underpinned by persistent racial, colonial and gendered structures of power, for which most engineering students do not have either the awareness to recognise, or the language to explore. As recognised by Downey (2015), there is “*continued dominance across many countries of an image of engineering formation that places highest value on mathematical problem solving*”. This prioritisation of mathematical processes leaves engagement with ‘fuzzier’ social, moral and ethical issues to the periphery of the curriculum. Yet the ability of students to unpick and explore the social context of the situation is a pre-requisite for an appropriate level of socially just ‘problem definition’.

In the process of finding an appropriate pedagogy for the course, the teaching, learning and assessment strategy is moving towards the integrative approach suggested by Jamison (2014). This proposes a dramatic shift from the traditionally value-neutral, context-light paradigm of engineering education towards a recognition that engineering both informs and is informed by social, environmental and economic factors. It necessitates changing how engineering is viewed and practised, and places weight on understanding how both personal agency and professional agency interplay with wider context.

Three principle interventions have aided the transition for engineering students:

Needs assessment adopting techniques drawn from grounded theory

Grounded theory (Glaser & Strauss, 1967) is a qualitative research method that uses observation data and inductive reasoning to build context-specific theoretical foundations from which to plan appropriate interventions. Since engineering students are traditionally educated in deductive research methods following the scientific method, inductive approaches are an unknown methodology. By broadening their toolkit of methodological techniques, the aim is to assist the students to be able to switch consciously between inductive and deductive modes appropriate to the situation. This is to combat the tendency of the engineering students to solve problems before they have spent enough time understanding the underlying need and root causes of a situation.

Empathetic design thinking

Design Thinking (Brown & Wyatt, 2010) is a human-centred approach to design that prioritises empathy, root cause analysis and allows space for creative ideation. It has been the experience of the course educators that many enrolled engineering students often lack creative skills, and do not use a wide field of inspiration to stimulate design. Teaching design thinking and ideation methods (designing extreme solutions, proliferation of design ideas etc.) has helped the students to come up with a wider range of more creative solutions during design development.

Critical Reflection

The use of critical reflection, in particular the use of Reynolds (1998) framework requires bringing issues around social power to the fore for analysis and evaluation. Individual privilege, race, gender and colonialism are issues that are discussed both in the classroom and in one to one advice sessions. This is a visibly uncomfortable process for some students, particularly those who are unaware of how their privilege manifests. After their initial immersion trip to visit their partner, students are encouraged to identify one or more ‘critical incidents’ which caused them discomfort, and reflect on that situation from their own perspective and the perspectives of others, drawing on knowledge from established and informal (e.g. blogs) literature to triangulate their experience against wider theory. This helps to draw out how the students’ own positionality is a factor that affects daily interactions, affecting every stage of the project, from how well they can understand the underlying need to how effectively and equitably they can conduct work with their project partner. The aim is to have students conscious that they may be unwittingly reproducing unhelpful power dynamics in their relationship with their partner. Many students come to the course with a ‘server-served’ attitude, and the aim of critically reflective practice

to move them towards an interdependent relationship striving for equity, recognising that all project partners have agency (Bruce, 2018). The consequence of this is that many students start to question whether it is right that their learning experience is occurring potentially at the expense of the time and effort of their partners. It is positive that they are asking the teaching staff these questions, as it evidences a critical mindset in action. However, this is a conversation that most engineering educators are not equipped to deal with, and where the partnership with social scientist colleagues on this program is invaluable.

The engineering practitioner's perspective: a balancing act between academia, project delivery and community impact

Whilst the benefits of experiential learning through GSL projects has been observed by the SEM4ID course instructors, the measure of success for the course is not as straight forward as just meeting the desired learning outcomes. There is also a huge social and ethical responsibility to ensure that the projects serve the communities where they are based (Larsen, 2016). A key challenge for the course is in striking a balance between meeting the community's needs, students meeting the desired learning outcomes, and also on some level, to fulfil the intended research output. The academic institution and students stand to gain from the typical GSL process, irrespective of the project outcome, but where does this leave the community and the other stakeholders? Of course, the goal and desired outcome is to create positive impact for the community, however, the responsibility of simply 'doing no harm' is just as challenging (Hartman and Kiely, 2014).

For GSL, there is an increased demand for accountability and demonstration of community impact and global learning outcomes, followed by academic research to outline priorities, key issues, questions, and dilemmas for GSL in practice (Lough & Toms, 2018). Academia aside, from a practitioner's perspective, it is a challenge to deliver an engineering project which is deemed successful by all stakeholders, whether it is in a developed or developing setting. In a 2015 KPMG Global Construction Survey, it was found that 53% of the owners of projects suffered from underperforming projects in the previous year (KPMG, 2015). Community capacity building is also no easy feat, even for well-established development practitioners with resources. While the World Bank has invested billions of dollars on hundreds of projects in Africa over decades, the failure rate of projects was over 50% (Dugger, 2007). Many other agencies and donor countries have not performed with much more success (Associated Press, 2007). If it is difficult for experienced professionals to get it 'right', then what chance do MSc students have in delivering successful projects, when they are constrained by the academic schedule, limited by uncertain financial resources and the lack of experience?

What the SEM4ID MSc projects aim to achieve is very challenging, the academics supporting the projects are learning just as much from the students and the community partners in order to make continuous improvements to how the projects are managed and run. To this extent, it is aimed that the projects at least 'do no harm' for the communities they support in the in the first instance, and with time, experiential learning and effective partnering, some of the projects may be able to deliver positive impacts for the communities. Along the way of project delivery there are opportunities for all those involved, including the students, academics, the local community, NGOs and the local civil and government organisations to learn from the experience. It is hoped that the SEM4ID MSc projects can provide case studies and examples of bottom-up community capacity building, which could be used as learning resources and serve communities in similar settings.

A key limitation in project delivery is posed by the nature of it being MSc research and the confining logistic constraints, this was highlighted by a project from the 18/19 cohort. The project team worked

closely with a school in Zambia to identify that one of the issues the school faced was their water supply. The school was putting all their resources into paying for water from a water company. Consequently, the school was not able to run their food programme for poorer pupils and they had to levy pupils for fees, which is discouraged by the Zambian government (MGE Zambia, 1996). Working together with the school, the project team focused on the solution of providing the school with a borehole. With a more accessible water source, as well as everyday use, the water from the borehole could facilitate an aquaponics system, which has the potential to further enhance the school's income generating capabilities. Following the initial needs assessment supported by a structured co-design process with the school, the students diligently applied for a grant to fund the borehole and obtained further resources through crowd funding and built an aquaponics system. The aquaponics system was built in the three-week period designated for project delivery, just before the cohort completed their studies.

Whilst the aquaponics system was built, the project is far from being complete. Much more work is required to ensure that the system is well maintained and when the system is not working, investigative work is done to identify the cause to enable further improvement. The school does not have the technical capacity and resource to be able to make the necessary technical improvements to the system. In order to support the school, a new project team from the 19/20 cohort will continue the aquaponics research work and the SEM4ID course will continue to support the aquaponics project until a stage when the system is sufficiently developed and the school has built capacity to run it independently. This may take a number of years, which was not accounted for at the project conception. In recognition that in order to complete projects meaningfully, it may take more than one student in take, some elements of the course will be redesigned to give space for long-term project planning which includes clear monitoring and evaluation processes to be managed by multiple cohorts.

Despite strategically designing a number of modules to develop students' skills in communication and managing complex relationships, and creating tools to help them function sensitively in a foreign cultural setting, communication, both internally within the multidiscipline and multinational teams and between the teams and the stakeholders remains challenging. Feedback and reflections from the students indicate that they learn the most from application of the theory learnt in the field. However, the learning process takes time, it has been observed that for most projects, effective communication only starts to happen towards the end of the project (Xavier & Holness, 2018). From a project delivery perspective, whilst the students could make a genuine contribution through their work, the project outcome is again limited by the available time in the field. To further support the communication process, we will explore providing the students and community partners with a broader course level terms of engagement, outlining the typical roles and responsibilities of partners on a SEM4ID MSc project and provide more support for project teams to develop their project specific amendments.

Conclusion

The SEM4ID MSc is still in its early years and in this paper, we focus on course development rather than detailing the observed benefits to date. This paper is deliberately written from the different voices and perspectives of some of the academics involved in the SEM4ID MSc conception, delivery and development. Whilst the collective vision and goals for the course are the same, when these are put under different lenses with varying focal points, what we individually observe and perceive as lessons learned, the challenges of stepping outside the box and the necessary future development of the course, take different shapes. Collectively, the process of working together to reflect on where the course has come from, where it is now and where it needs to go in the future and how to get there, aligning our slightly different priorities and points of views and translating these into changes, is essential to the course survival and future success. This process is also the essence of multidisciplinary work and

transdisciplinary learning. The voices of the host communities and other partners we work with is missing from this narrative. This is something we hope to explore this in more depth in the future.

References

- Associated Press. 2007. *Examples of failed aid funded projects in Africa. Oil pipeline, fish processing plant are a few of the unsuccessful ones.* http://www.msnbc.msn.com/id/22380448/ns/world_news-africa/t/examples-failed-aid-funded-projects-africa/
- Blumenfeld, P. C., Soloway, E., Marx, R. W., Krajcik, J. S., Guzdial, M. & Palincsar, A. 1991. Motivating Project-Based Learning: Sustaining the Doing, Supporting the Learning. *Educational Psychologist*, **26 (3-4)**, 369-398.
- Brown, T. and Wyatt, J. 2010. *Design Thinking for Social Innovation.* www.ssireview.com
- Brown, T. and Wyatt, J. 2015. Design Thinking for Social Innovation. *Annual Review of Policy Design*, **3**, 1-10.
- Bruce, J. 2018. Postcritical Service-Learning. *The Wiley International Handbook of Service-Learning for Social Justice*, D.E. Lund (Ed.). doi:[10.1002/9781119144397.ch9](https://doi.org/10.1002/9781119144397.ch9)
- Downey, G. 2015. PDS: Engineering as Problem Definition and Solution. In Byron Newberry, Carl Mitcham, Martin Meganck, Andrew Jamison, Christelle Didier & Steen Hyldgaard Christensen (eds.), *International Perspectives on Engineering Education*. Springer Verlag.
- Dugger, C.W. 2007. *World Bank finds its Africa projects are lagging*, New York Times. <http://www.nytimes.com/2007/08/02/world/africa/02worldbank.html>
- Forster, A., Pilcher, N., Tennant, S., Murray, M., Craig, N., & Copping, A. 2017. The fall and rise of experiential construction and engineering education: de-coupling and re-coupling practice and theory *Higher Education Pedagogies*, **2(1)**, 79-100.
- Glaser, B. G. & Strauss, A. L. 1967. *The Discovery of Grounded Theory. Strategies for Qualitative Research.* Chicago: Aldine.
- Hartman, E., & Kiely, R. 2014. Pushing boundaries: Introduction to the global service-learning special section. *Michigan Journal of Community Service Learning*, **21(1)**, 55-63.
- Jamison, A., Kolmos, A. and Holgaard, J. E. 2014. Hybrid Learning: An integrative approach to engineering education. *Journal of Engineering Education*. American Society for Engineering Education, **103(2)**, 253–273. doi: 10.1002/jee.20041
- Jenkins, J. & Peters, K. 2016. Improving Rural Connectivity in Africa with Motorcycle Tracks in Transport, *Special Issue: Transport and Global Poverty*, **169 (6)**, 378–386.
- KPMG. 2015. *Climbing the curve, 2015 Global Construction Project Owner's Survey.* <https://assets.kpmg/content/dam/kpmg/pdf/2015/04/2015-global-construction-survey.pdf>
- Larsen, M. A. 2016. *International Service-Learning, Engaging Host Communities.* New York: Routledge

- Leliveld, A. & Knorringa, P. 2018. Introduction; Frugal Innovation and Development Research. *European Journal of Development Research*, **30(1)**, 1-16. <https://doi.org/10.1057/s41287-017-0121-4>
- Lough, B. J., Toms, C. 2018. Global service-learning in institutions of higher education: concerns from a community of practice. *Globalisation, Societies and Education*, **16(1)**.
- Ministry of General Education - Government of the Republic of Zambia. 1996. *Educating Our Future: National Policy on Education*. May 1996. Lusaka. Institutional Suppliers Limited. http://www.moge.gov.zm/?wpfb_dl=55
- Peters, K., Jenkins, J., Mokuwa, E., Richards, P., & Johnson, T. 2018. *Upgrading Footpaths to Motorcycle Taxi accessible Tracks: Accelerating Socio-economic Development in rural Sub-Saharan Africa*. <http://www.research4cap.org/Library/Petersetal-SwanseaUni-2018-UpgradingFootpathstoMotorcycleTaxiaccessibleTracks-PolicyBrief-181217.pdf>
- Reynolds, M. 1998. Reflection and critical reflection in management learning. *Management Learning*, **29(2)**, 183–200.
- Todaro, M. 2000. *Economic Development*. 7th Edition. Addison-Wesley
- Xavier, P. A. & Holness, R. J. 2018. Co-educating Social Scientists and Engineers through International Service Learning. *World Engineering Education Forum - Global Engineering Deans Council (WEEF-GEDC)* doi: [10.1109/WEEF-GEDC.2018.8629676](https://doi.org/10.1109/WEEF-GEDC.2018.8629676)



University College Cork, Ireland
14th June – 16th July 2021