

Title	Energy harvesting for a green internet of things: PSMA white paper
Authors	Becker, T.;Borjesson, V.;Cetinkaya, O.;Baoping, C.;Colomer-Farrarons, J.;Maeve, D.;Elefsiniotis, A.;Govoni, L.;Hadas, Z.;Hayes, M.;Holmes, A. S.;Kiziroglou, M. E.;La Rosa, R.;Miribel-Català, P.;Mueller, J.;Pandiyana, A.;Plasek, O.;Riehl, P.;Rohan, James F.;Sabaté, N.;Saez, M.;Samson, D.;Sebald, J.;Spies, P.;Vikerfors, A.;Yeatman, E.;Zaghari, B.;Zahnstecher, B.
Publication date	2021-09-30
Original Citation	Becker, T. and Kiziroglou, M. E. (Eds). (2021) Energy harvesting for a green internet of things, PSMA White Paper, Calif., USA: PSMA Energy Harvesting Technical Committee. isbn: 978-1-7337815-2-7
Type of publication	Report
Link to publisher's version	https://www.pdma.com/technical-forums/energy-harvesting/whitepaper
Rights	© 2021 PSMA. This work is licensed under a Creative Commons Attribution 4.0 International License (https://creativecommons.org/licenses/by/4.0/). - https://creativecommons.org/licenses/by/4.0/
Download date	2024-07-13 18:16:52
Item downloaded from	https://hdl.handle.net/10468/13287



UCC

University College Cork, Ireland
Coláiste na hOllscoile Corcaigh



"Powering the Internet of Things"

PSMA

The Multinational Power Electronics Association

ENERGY HARVESTING FOR A GREEN INTERNET OF THINGS



ISBN: 978-1-7337815-2-7

Energy Harvesting for a Green Internet of Things

Lead Editors: Thomas Becker, Michail E. Kiziroglou

Chapter Editors: Thomas Becker, Maeve Duffy, Bahareh Zaghari, Michail E. Kiziroglou

PSMA: Mike Hayes, Brian Zahnstecher

Authors:

Name	Affiliation	Place
<i>Becker, Thomas</i>	<i>thobecore consulting & research</i>	<i>Bremen Area, Germany</i>
<i>Borjesson, Viktor</i>	<i>ReVibe Energy</i>	<i>Gotenburg, Sweden</i>
<i>Cetinkaya, Oktay</i>	<i>University of Sheffield</i>	<i>Sheffield, United Kingdom</i>
<i>Chen, Baoxing</i>	<i>Analog Devices</i>	<i>Wilmington, USA</i>
<i>Colomer-Farrarons, Jordi</i>	<i>University of Barcelona</i>	<i>Barcelona, Spain</i>
<i>Duffy, Maeve</i>	<i>National University of Ireland</i>	<i>Galway, Ireland</i>
<i>Elefsiniotis, Alexandros</i>	<i>-/-</i>	<i>Munich, Germany</i>
<i>Govoni, Leonardo</i>	<i>AED Engineering</i>	<i>Munich, Germany</i>
<i>Hadas, Zdenek</i>	<i>Brno University of Technology</i>	<i>Brno, Czechia</i>
<i>Hayes, Mike</i>	<i>Tyndall National Institute</i>	<i>Cork, Ireland</i>
<i>Holmes, Andrew S.</i>	<i>Imperial College London</i>	<i>London, United Kingdom</i>
<i>Kiziroglou, Michail E.</i>	<i>Imperial College London</i>	<i>London, United Kingdom</i>
<i>La Rosa, Roberto</i>	<i>ST Microelectronics & Ecole Polytechnique Federale de Lausanne</i>	<i>Catania, Italy & Lausanne, Switzerland</i>
<i>Miribel-Català, Pedro</i>	<i>University of Barcelona</i>	<i>Barcelona, Spain</i>
<i>Mueller, Jan</i>	<i>Airbus</i>	<i>Hamburg, Germany</i>
<i>Pandiyana, Akshayaa</i>	<i>Imperial College London</i>	<i>London, United Kingdom</i>
<i>Plasek, Otto</i>	<i>Brno University of Technology</i>	<i>Brno, Czechia</i>
<i>Riehl, Patrick</i>	<i>Analog Devices</i>	<i>Wilmington, USA</i>
<i>Rohan, James</i>	<i>Tyndall National Institute</i>	<i>Cork, Ireland</i>
<i>Sabaté, Neus</i>	<i>Fuelium</i>	<i>Bellaterra, Spain</i>
<i>Saez, Manuel</i>	<i>AED Engineering</i>	<i>Munich, Germany</i>
<i>Samson, Dominik</i>	<i>Elatec</i>	<i>Puchheim, Germany</i>
<i>Sebald, Johannes</i>	<i>Ariane Group</i>	<i>Bremen, Germany</i>
<i>Spies, Peter</i>	<i>Fraunhofer IIS</i>	<i>Erlangen, Germany</i>
<i>Vikerfors, Andreas</i>	<i>ReVibe Energy</i>	<i>Gotenburg, Sweden</i>
<i>Yeatman, Eric M.</i>	<i>Imperial College London</i>	<i>London, United Kingdom</i>
<i>Zaghari, Bahareh</i>	<i>Cranfield University</i>	<i>Cranfield, United Kingdom</i>
<i>Zahnstecher, Brian</i>	<i>PowerRox</i>	<i>San Jose, United States</i>

Executive Summary

This white paper is recommended for everyone dealing with energy harvesting; business leaders world-wide can increase their understanding of the cost and benefits of maintenance-free power supplies. Representatives of environment protection institutions can appreciate the key role of energy harvesting technology. Journalists can learn about a representative set of use cases for reliable and autonomous operation. Decision makers are provided with essential information that allows them to assess the potential of energy harvesting in a given Internet of Things (IoT) applications. Engineers are confronted by the key challenges for future deployment, and researchers explore the need for innovation advancement beyond conceptual technology demonstrations.

This white paper has been prepared by an enthusiastic team devoted to energy harvesting solutions for a green internet of things. The work has been performed on a voluntary basis under the umbrella of the Power Sources Manufacturers Association (PSMA). The composition of the team ranges from scientists, engineers, and small to medium enterprise representatives to industrial stakeholders, offers a broad range of insights into the world of energy harvesting. The key conclusion is that energy harvesting technology has already achieved, in practice and in real environments, the required power density for energy autonomous wireless sensors, as demonstrated in several bespoke use cases. Industry is cautious and slow in adoption of the new solutions due to the requirement for application-specific power supply design for each use case. A turn-key solution with guaranteed functionality and reliability is an essential requirement of industrial users and forms a key missing element in energy harvesting. The high economic and environmental advantage of energy autonomy; due to functionality, maintenance, reliability, and low waste/pollution benefits; makes it essential to sustainable IoT. Addressing these key missing elements, through targeted scientific focus and investment by the environment and technology stakeholders, is a topmost priority.

For the convenience of the interested reader, the content is divided into five sections: Section 1 tours different harvesting device types – able to transfer ambient into electrical energy – focusing on operational concept, performance, and shape. The use cases in Section 2 describe the procedure of developing energy autonomy solutions for Wireless Sensor Network (WSN) nodes, including several representative application examples. A critical review of missing aspects for rapid industrial adoption is given in Section 3. Cost-benefit analysis and life-cycle assessments studies are provided in Section 4, revealing the key role of energy. The future research needs are outlined in Section 5, offering a holistic view of the innovation potential of energy harvesting toward a green Internet of Things.

Key Findings

- *Energy harvesting is a key enabling technology for the green Internet of Things.*
- *The potential is demonstrated several use cases.*
- *Industrial adoption is reluctant despite positive cost-benefits and life-cycle impacts.*
- *Massive future deployment requires a concerted strategy in research and technology accompanied by disruptive industrial product developments and innovations!*

Abstract

The ubiquitous nature of energy autonomous microsystems, which are easy to install and simple to connect to a network, make them attractive in the rapidly growing Internet of Things (IoT) ecosystem. The growing energy consumption of the IoT infrastructure is becoming more and more visible. Energy harvesting describes the conversion of ambient into electrical energy, enabling green power supplies of IoT key components, such as autonomous sensor nodes.

Energy harvesting methods and devices have reached a credible state-of-art, but only a few devices are commercially available and off-the-shelf harvester solutions often require extensive adaption to the envisaged application. A synopsis of typical energy sources, state-of-the-art materials, and transducer technologies for efficient energy conversion, as well as energy storage devices and power management solutions, depicts a wide range of successful research results. Developing power supplies for actual usage reveals their strong dependence on application-specific installation requirements, power demands, and environmental conditions.

The industrial challenges for a massive spread of autonomous sensor systems are manifold and diverse. Reliability issues, obsolescence management, and supply chains need to be analyzed for commercial use in critical applications. The current gap between use-case scenarios and innovative product development is analyzed from the perspective of the user. The white paper then identifies the key advantages of energy autonomy in environmental, reliability, sustainability, and financial terms.

Energy harvesting could lead to a lower CO₂ footprint of future IoT devices by adopting environmentally friendly materials and reducing cabling and battery usage. Further research and development are needed to achieve technology readiness levels acceptable for the industry. This white paper derives a future research and innovation strategy for industry-ready green microscale IoT devices, providing useful information to the stakeholders involved: scientists, engineers, innovators, the general public, and decision makers in industry as well as in public and venture-funding bodies. This inclusive strategy could bridge the energy harvesting technology frontier and the IoT node power demands to create value.

About PSMA and EHC

The Power Sources Manufacturers Association (PSMA www.pdma.com) is a US-based international non-profit organization whose purpose is “*to enhance the stature and reputation of its members and their products, improve their knowledge of technological and other developments related to power sources, and educate the entire electronics industry, plus academia, as well as government and industry agencies as to the importance of, and relevant applications for, all types of power sources and conversion devices*”. With over 200 member organizations, it is known internationally for its co-sponsorship of APEC (with IEEE PELS & IAS), the world’s largest annual power electronics conference, as well as its Power Technology Roadmap. PSMA also co-hosts workshops like PwrSoC, EnerHarv, and IWIPP, as well as technical publications in areas such as packaging and reliability.

The Energy Harvesting Committee (EHC) is one of 12 committees within PSMA that focuses on particular power electronics technologies (from materials to devices and systems) and/or applications. Our EHC includes over 50 professionals from industry and academia who collaborate to collect compartmentalized constituents of an emerging technology area and assemble the information in a meaningful way that connects critical stakeholders and provides the appropriate ecosystem to propel it into the mainstream.

Since its inception in 2016, EHC has hosted industry sessions annually at APEC, including technical presentations and functional demonstrations of energy harvesting (EH) enabled IoT / IIoT / wearable / sensors. In May 2018, EHC organized a three-day workshop called EnerHarv (<http://www.enerharv.com/>), hosted by Tyndall (<https://www.tyndall.ie/>) in Ireland. EnerHarv proved a palpable inflection point for members of the power IoT/ EH ecosystems to increase collaboration and successfully bring solutions to the mainstream. EnerHarv was highly successful and will become a biennial event starting in April 2022, hosted by the ASSIST Center (<https://assistcenter.org/>) of North Carolina State University in Raleigh, NC, USA.

This white paper is one of the most significant and pivotal outputs from EHC to date (along with EnerHarv and the ecosystem built around its activities).

Acknowledgements

The editors and authors would like to thank the PSMA for their support, especially for providing the virtual meeting infrastructure, enabling a continuous workflow, and providing methodologies and channels to publish this paper. Moreover, the editors would like to thank the Energy Harvesting Committee for initializing and assisting with the white paper preparation.

Key Words

Energy Harvesting, Internet of Things, Industrial IoT, Power IoT, Green, Cost Benefits, Life Cycle Assessment, Research & Innovation, Medical Wearables, Industrial Adoption & Use Cases.

Disclaimer

This paper is published by PSMA for interested parties to use and to stimulate collaborations. It focuses particularly on the power IoT arena in addressing battery life issues for ultra-low power wireless sensor devices. Any reproduction of material herein should be appropriately cited and referenced. PSMA should be made aware of this in advance where practicable. PSMA accepts no liability for misuse, design decisions, or injury as a result of the information provided here. This paper reflects the authors’ views and PSMA is not responsible for any use that may be made of the information it contains. This work is licensed under a Creative Commons Attribution 4.0 International License (<https://creativecommons.org/licenses/by/4.0/>).

*For more information on the PSMA,
its members, its committees, recent activities, other publications,
or to join the PSMA, visit our website at:
<https://www.pdma.com>*

Table of Contents

1. State-of-the-Art from the Perspective of the User	7
1.1. Energy Harvesting Sources	7
1.1.1. Motion	7
1.1.2. Solar	8
1.1.3. Thermal	10
1.1.4. Energy Harvesting from Electrical Power Lines	12
1.1.5. Radio Frequency and Wireless Power Transfer (WPT)	14
1.1.6. Acoustic.....	15
1.2. Energy Storage.....	18
1.2.1. Batteries.....	18
1.2.2. Supercapacitors	20
1.3. Energy Harvesting Management.....	21
1.3.1. Micro-Power Management.....	21
1.3.2. Functionality / Low Power Loads	23
1.4. State-of-the-Art Summary.....	25
2. Developing for a Use Case	26
2.1. Setting Specifications and Developing Solutions for a Use Case	26
2.2. Energy and Power Budgeting.....	26
2.3. Use Cases.....	27
2.3.1. Air Flow Energy Harvesting for Environmental Control in Buildings.....	27
2.3.2. Thermal-Powered Wireless Screw Connection	30
2.3.3. Innovative Sensorless and Battery-Free Platform to Monitor Ambient Light.....	32
2.3.4. Remotely Powered Temperature Sensor for Monitoring Food Cooking.....	35
3. Key Elements for Industrial Adoption	38
3.1. The Industrial Challenge	38
3.2. Component Level.....	38
3.3. Industrial Perspectives.....	39
3.3.1. Electronics Industry.....	39
3.3.2. Energy Harvesting in Aviation — Aircraft Manufacturer Perspective.....	41
3.3.3. Buildings and Physical Access Control.....	43
3.3.4. Space Industry, Launcher Perspective.....	45
3.3.5. Spatial Localization Perspective.....	46
3.4. Railway Infrastructures	48
3.4.1. Motivation in Railways	49
3.4.2. Deployed Energy Harvesting Technologies and Potential for Future Development	49
3.4.3. Key Elements for Trackside Energy Harvesting Development.....	51
3.4.4. Conclusions	52
3.5. Healthcare	53
4. Key Advantages	56
4.1. Cost Benefit.....	56
4.2. Reliability.....	57
4.3. Sustainability.....	58
5. Innovation and Future Research	61
5.1. Technology Research.....	61
5.2. Development and Sustainability.....	63
5.3. Industry and Innovation	64

1. State-of-the-Art from the Perspective of the User

Editor: Maeve Duffy

The increasing demand for Wireless Sensor Nodes (WSNs) that are able to collect and transmit data through wireless communication channels, whilst often positioned in locations that are difficult to access, is driving research into innovative solutions involving energy harvesting (EH) and wireless power transfer (WPT) to eventually allow battery-free sensor nodes. An overview of the range of research in EH sources, storage, and power management technologies are presented in this section, including a summary of available power and energy levels. Established commercial technologies are discussed, followed by emerging technologies under development in research laboratories.

1.1. Energy Harvesting Sources

1.1.1. Motion

Author: Andreas Vikerfors

In most cases, the principle of vibration energy harvesters is based on a mass-spring-damper system with one degree of freedom. There are various ways to transform kinetic energy into electrical energy, with the four most common transduction mechanisms in energy harvesting applications being: electrostatic, piezoelectric, electromagnetic, and magneto restrictive. The electromagnetic transduction mechanism is the most common in available commercial applications. Since the first electromagnetic vibration energy harvesters (EVEH) were proposed in the late 1990s^[1], a lot of transducers have been developed through the years. The most common type of EVEH is based on a mass-spring-damper system that generates energy as the ambient vibrations have a frequency content close to the resonant frequency of the mass-spring system.

Design Challenges: There are a few known design limitations with EVEH and a lot of research and development has been invested around these. The first and most challenging is the slim operational bandwidth because power extraction occurs around the resonance frequency with only a few Hz bandwidth. Different wideband technologies have attracted interest by researchers; PWL (Piece Wise Linear)^[2], non-linear springs^[3], and a bi-stable system^[4]. So far, there has not been any significant breakthrough to solve the frequency dependency of EVEH and, as linear EVEH still performs well, it remains the primary option. The second is the scalability issue, as the power output potential correlates strongly with size, or more precisely with the oscillating mass. This limitation has made it difficult to miniaturize products and still be able to provide enough power. As sensors get more and more power-efficient, it reduces the need for high-power output from the EVEH.

Design Optimization: When designing the EVEH, it is important to use a smart architecture whereby as much volume as possible can be utilized in the effective generator part, which includes magnets, coils, etc. But it is not only power generation that is important when designing an EVEH. The most important aspect of choosing to integrate an EVEH in the sensor node, instead of only relying on batteries, is that this should increase the lifetime of the sensor node considerably. That puts difficult requirements on the EVEH to survive long enough with its performance intact. The most vulnerable parts are the mechanical springs that are constantly subjected to stress, making fatigue failures a risk^[5]. Other key design choices; such as coil wire thickness, magnetic field strength, and oscillating mass; need to be matched with the intended vibration environment to ensure that the induced voltage is high enough to be rectified and stored^[5]. Moreover, the DC power management needs to be designed with

¹ Williams, C.B., Yates, R.B., "Analysis of micro-electric generator for microsystems", *The 8th International Conference on Solid-state Sensors and Actuators and Eurosensors IX*. Stockholm, Sweden, June 25-29, 1995.

² Meng-Hsuan Tien, Kiran D'Souza. "Method for controlling vibration by exploiting piecewise-linear nonlinearity in energy harvesters", Published: 08 January 2020 <https://doi.org/10.1098/rspa.2019.0491>.

³ Duy S. Nguyen, Einar Halvorsen. "ANALYSIS OF VIBRATION ENERGY HARVESTERS UTILIZING A VARIETY OF NONLINEAR SPRINGS", Department of Micro and Nano Systems Technology, Vestfold University College, Norway.

⁴ Pranay Podder, Dhiman Mallick, Andreas Amann & Saibal Roy. "Influence of combined fundamental potentials in a nonlinear vibration energy harvester", *Nature Scientific Reports* Published: 22 November 2016.

⁵ ReVibe Energy AB, <https://revibeenergy.com>, Sweden, November 2020.

the EVEH to maximize the efficiency of the complete system^[5]. Custom optimization rather than one solution fits all seems to be the winning approach in most applications.

Commercial Products: Several commercial companies now offer EVEH technology, including ReVibe Energy AB based in Sweden, Kinergizer based in the Netherlands, and UK-based 8power. A currently available industrial EVEH can deliver 54 mW Dc charge power with 7 Hz half-power bandwidth subjected to 1 g acceleration with a total device mass of only 100 g^[5].



Figure 1 — ModelD - Commercial Available EVEH with the Same Size as D-Sized Battery^[5]

1.1.2. Solar

Author: Maeve Duffy

Solar cells convert radiant light into electrical energy. According to the photovoltaic (PV) effect, minority carriers in the semiconductor material are released to provide current levels proportional to the level of solar irradiation. Outdoor photovoltaic installations on the order of kilowatts are well known sources of electricity for domestic and commercial buildings. However, the main focus in this paper is module- and cell-scale PV sources that can be integrated with wireless sensor systems.

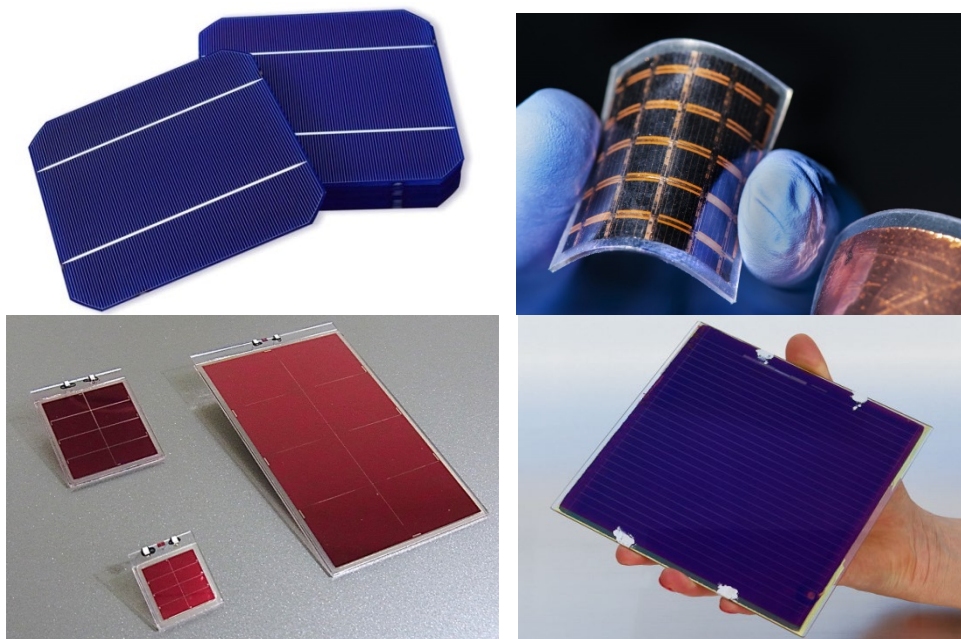

Figure 2 — Common Solar Cell Types (a) Monocrystalline Silicon^[6], (b) GaAs^[7], (c) DSSC^[8], (d) Perovskite^[9]

⁶ www.isolarpartner.com

Materials: The range of most common photovoltaic material types are shown in Figure 2 and their performance is compared in Table 1 in terms of their open-circuit voltage and maximum output power density. GaAs cells produce the highest output power levels, but at a cost that limits them to specialist high-performance applications, such as aerospace^[10]. Cost is reduced in DSSCs, which involve much simpler manufacturing processes and have the next highest power density. Interest in Perovskite cells is driven by low cost and the high rate of development^[11].

Most PV cells are produced in rigid form, though there are increasing ranges of flexible cells available for integration within buildings and other structures. Their performance is generally 5 - 9% lower in efficiency than rigid cells, but integration in existing structures make their size and weight less critical and they can be sized to produce specific required power levels^[12].

Table 1 Solar Cell Performance vs. Type; Indoor Light Intensity (77.40 $\mu\text{W}/\text{cm}^2$)^[13]

<i>Type of Solar Cell</i>	<i>Open Circuit Voltage oc (V)</i>	<i>Power Density at MPP* ($\mu\text{W}/\text{cm}^2$)</i>
<i>Crystalline silicon</i>	2.0	7.91
<i>Polycrystalline silicon</i>	1.5	3.99
<i>Amorphous silicon</i>	2.89	12.07
<i>Dye-sensitized solar cell (DSSC)</i>	0.60	22.0
<i>GaAs</i>	0.90	26.07
<i>Perovskite (CaTiO₃)</i>	0.71	19.32

(*MPP = Maximum Power Point)

Applications: The majority of cell-scale PV sources have been developed for use with indoor light sources to supply IoT sensors within buildings, though some are also applied for environmental sensing outdoors^[14]. Recently, researchers at MIT have applied thin-film Perovskite cells onto RFID tags that have been demonstrated in remote temperature sensing indoors and outdoors^[15].

When integrated with small-scale energy harvesting for IoT applications, the lower voltage produced by DSSC, GaAs, and Perovskite cells (relative to Silicon) requires a voltage step-up circuit stage to deliver the power to wireless sensor loads that typically operate at 1.8 – 3.3 V. Nonetheless, with DC-DC converter efficiencies of up to 90%^[16,17], these cells still provide competitive power levels per unit area (see Section 1.3.1). Recognizing the need for energy storage within such a system, increasing efforts are being directed towards the development of integrated PV storage systems where the effects of interconnects between the energy source and storage components are minimized and the need for Dc-Dc conversion between source and storage is reduced by matching operating voltage levels^[18].

⁷ Mark Hutchins, "Nothing can bring down the price of III-V solar cells – just add germanium", *PV Magazine*, June 10th, 2019, <https://www.pv-magazine.com/2019/06/10/nothing-can-bring-down-the-price-of-iii-v-solar-cells-just-add-germanium/>.

⁸ "Complete Solid-State Dye-Sensitized Solar Cell", https://www.ricoh.com/technology/tech/066_dssc.

⁹ With courtesy of Solliance Solar Research, photo by Niels van Loon, <https://www.solliance.eu/2016/solliance-partners-present-first-semi-transparent-perovskite-module/>.

¹⁰ Marian Willuhn, "Not just for outer space: NREL has a path to cheaper GaAs solar cells", *PV Magazine*, JANUARY 13, 2020, <https://pv-magazine-usa.com/2020/01/13/solar-cells-from-space-are-on-the-way/>.

¹¹ Maria Gallucci, "Perovskite Solar Out-Benches Rivals in 2021", *IEEE Spectrum Tech Talk* blog, <https://spectrum.ieee.org/tech-talk/energy/renewables/oxford-pv-sets-new-record-for-perovskite-solar-cells>.

¹² Anthony King, 'Lightweight, bendy, cheaper – the promise of organic solar panels', Oct. 2020, <https://horizon-magazine.eu/article/lightweight-bendy-cheaper-promise-organic-solar-panels.html>.

¹³ M. Rasheduzzaman, P. B. Pillai, A. N. C. Mendoza and M. M. De Souza, "A study of the performance of solar cells for indoor autonomous wireless sensors," 2016 10th *International Symposium on Communication Systems, Networks and Digital Signal Processing (CSNDSP)*, 2016, pp. 1-6.

¹⁴ Himanshu Sharma, Ahteshamul Haque, Zainul A. Jaffery, 'Solar energy harvesting wireless sensor network nodes: A survey', *J. Renewable Sustainable Energy* 10, 023704 (2018).

¹⁵ Rob Matheson, Photovoltaic-powered sensors for the "internet of things, Sept. 2019, <https://news.mit.edu/2019/photovoltaic-rfid-sensors-iot-0927>.

¹⁶ E-Peas Semiconductor AEM10941 Highly-efficient, regulated dual-output, ambient energy manager for up to 7-cell solar panels with optional primary battery, 2018.

¹⁷ Linear Technology LTC3105 400 mA Step-Up Dc-Dc, Converter with Maximum Power, Point Control and 250 mV Start-Up.

¹⁸ Yuhan Wu, Chao Li, Zhengnan Tian, Jingyu Sun, 'Solar-driven integrated energy systems: State of the art and challenges', *Journal of Power Sources*, Volume 478, 2020, 22876.

Practically, unless indoor lighting is on 24-7, solar cells need to be combined with energy storage to maintain continuous sensor operation. There may also be issues with cell shading due to the build-up of dirt and dust that requires some level of maintenance. However, most commercial / industrial buildings have repetitive lighting schedules, which can be combined with careful system design to support close to autonomous operation. On the other hand, variable weather conditions cause complications in outdoor applications.

Commercial Products: Commercially, silicon-based products are well established in companies such as SunPower and Silicon Solar. GaAs is available for specialist applications from companies like NanoFlex Power Corporation and Azur Space. Efforts towards commercialization of Perovskite cells are on-going to address issues with reliability, while reliability has been largely overcome in DSSCs with companies, such as Fujikura and Ricoh, providing products for indoor and outdoor applications.

1.1.3. Thermal

Author: Alexandros Elefsiniotis

In 1820, Thomas Johann Seebeck discovered the thermoelectric phenomenon, which is the basis of thermoelectric energy harvesting. He reported that “a magnetic compass needle is deflected when the junctions in a closed loop of two dissimilar metals or semiconductors are at different temperatures”^[19], known as a thermocouple. This phenomenon, known as the Seebeck effect, describes the conversion of a temperature difference, such as a heat flux, to electrical energy.

This thermal-to-electrical conversion depends on the Seebeck coefficient and the thermal and electrical conductivities of the materials involved. The latter two are inversely proportional to each other and the factors express a dimensionless figure of merit, the so-called zT number. The figure of merit, zT , relates the Carnot efficiency, η_{Carnot} , to the overall efficiency of a thermoelectric generator (TEG), i.e. consisting of many thermoelectric elements, η_{TEG} , and this efficiency is always smaller than η_{Carnot} , as given by:

$$\eta_{\text{TEG}} = \frac{\sqrt{1 + zT_m} - 1}{\sqrt{1 + zT_m} + \frac{T_c}{T_h}} \cdot \eta_{\text{Carnot}} = \frac{\sqrt{1 + zT_m} - 1}{\sqrt{1 + zT_m} + \frac{T_c}{T_h}} \cdot \frac{\Delta T_{\text{TEG}}}{T_h}$$

where T_c, T_h are the cold and hot temperature on the thermoelectric generator, respectively, and T_m is the average of the two as $T_m = \frac{T_h + T_c}{2}$.

Material Developments: In the 1950s, Abram Ioffe discovered the thermoelectric properties of semiconductors, which was a huge step towards more efficient thermoelectric materials. Today, most thermocouples consist of highly doped positive and negative semiconductors. Thermoelectric materials are typically bulk doped semiconductor alloys or chalcogenides. For low-temperature applications (<150°C), bismuth telluride (Bi_2Te_3) is the most common material with a zT close to 1 at room temperature^[20]. Lead telluride (PbTe) is the most promising material for temperature ranges from 150° to 500°C, reporting up to a $zT=1.4$ using single-phase PbTe ^[20]. For higher temperatures, Silicon Germanium is one of the best materials with $zT= 1.88$ ^[20]. Other thermoelectric material groups reported in literature include skutterudites and clathrates ($zT \leq 1.5$), half-Heuslers, Zintl, nanostructures ($zT=2.2$ at 915 K^[21]), conducting polymers with zT up to 0.42^[20], metal oxides, and hybrid thermoelements^[22]. There is an increase in the number of publications on the above material categories, especially in the last ten years, providing an added value to the thermoelectric research^[22].

¹⁹ T. J. Seebeck, “Magnetische Polarisation der Metalle und Erze durch Temperatur-Differenz,” Abh. Akad. Wiss. Berlin, vol. 1822, pp. 289-346, 1820-21.

²⁰ Zoui, Mohamed Amine, et al. "A Review on Thermoelectric Generators: Progress and Applications." *Energies* 13.14 (2020): 3606.

²¹ A. Elefsiniotis, *Robust Energy Harvesting Modules for Aircraft Specific Wireless Sensor Nodes*, PhD Thesis 2015.

²² Selvan, Krishna & Hasan, Md & Mohamed Ali, Mohamed Sultan. (2018). State-of-the-Art Reviews and Analyses of Emerging Research Findings and Achievements of Thermoelectric Materials over the Past Years. *Journal of Electronic Materials*. 48. 10.1007/s11664-018-06838-4.

Design Optimization: Combining high zT thermoelectric elements to form thermocouples and connecting (typically) 10 to 100 thermocouples in parallel in terms of heat flux, and electrically in series, an ideal thermoelectric generator (TEG) is formed^[23]. Thermoelectric harvesters are devices consisting of one or multiple TEGs attached to a heat source and a heat spreader, making sure that the heat flux results in enough energy to power different devices.

Bateman reports that, at a system level, the maximum efficiency of a thermoelectric harvester is unlikely to be higher than 40% of the respective Carnot efficiency^[24]. Furthermore, Kishore et al. have reported that the figure of merit of a thermoelectric material decreases by 30-50% when assembled in a TEG, strongly affecting its performance^[25]. This shows a gap between the performance of the materials and the overall system design. The harvester system is essential to meet all the requirements posed by a specific application, with tests in the field also being necessary. Nonetheless, TEGs do not have any moving parts or fluids, making them silent and reliable. Additionally, TEGs can be scaled in size according to the thermal characteristics and electrical requirements of an application. These features, along with the zero additional emissions, make TEGs attractive to maintain an adequate power to weight ratio. On the other hand, TEGs have low efficiencies, with current maximum performances rating up to 11% in vitro^[25]. These low efficiencies are due to the semiconductors' innate low thermal conductivities^[22].

Applications: Some of the most remarkable applications providing state-of-the-art output efficiencies and power are summarized. An efficiency of around 0.1% is achieved in the watch industry, producing 22 μW at regular operation with a $\Delta T=1.5\text{ K}$ ^[26]. For other body sensors, flexible substrate TEGs have been developed, with one providing 32 nW at 40 K^[25]. For body area network sensors, roughly 100 μW may be achieved by thermal matching between the TEG and the environment^[27].

The aerospace industry is having a close look at thermoelectric harvesters. The difference between the outside and inside cabin temperature has drawn the attention of many possible applications. A novel thermoelectric harvester design using only one temperature gradient, i.e. the outside temperature and creating an artificial temperature on the other side, is presented^[23]. In that concept, the thermoelectric harvesters make use of phase-change materials and their latent heat. Different phase-change materials might be used according to the temperature gradient provided on one side of the TEG and the energy production is in the range of a few Joules (up to 30 J were achieved with 10 ml of phase-change material^[21]), enough to power ultra-low-power sensors, such as strain gauges.

Moving away from the ultra-low power thermoelectric harvesters, an area where a lot of research has been performed during recent years, is the automotive industry. A waste heat recovery system may harvest electrical energy and reduce the overall fuel consumption^[26]. As a comparison, fuel combustion provides 25% of its energy for vehicle operation, 30% for cooling, and 40% on the waste exhaust gases^[26]. For this reason, TEGs on exhaust systems have been studied. According to Shuhai et. al., a thermoelectric harvester with $zT = 1.25$ and an overall efficiency of 10% can recover roughly 35-40% of the exhaust system^[28].

Another interesting area where TEGs have been used is in aerospace applications. Many space vehicles are using nuclear radioisotopes, mostly Plutonium, in combination with TEGs to produce electrical power. The Mars 2020 Perseverance rover uses this technology to power up the space vehicle^[29]. According to NASA, around 110 W of electrical power is produced using radioisotopes and TEGs to power up and warm up the rover^[29]. The total power to weight ratio is 2.44 W/kg and NASA calls this power source a Multi-Mission Radioisotope Thermoelectric Generator (MMRTG)^[29].

²³ D. Samson, *Energy Harvesting in Aircraft with Special Focus on Thermoelectrics*, Dr. Hut, 2011.

²⁴ Bateman, P. J. "Thermoelectric power generation." *Contemporary Physics* 2.4 (1961): 302-311.

²⁵ Kishore, Ravi Anant, et al. "High-Performance Thermoelectric Generators for Field Deployments." *ACS Applied Materials & Interfaces* 12.9 (2020): 10389-10401.

²⁶ Enescu, Diana. (2019). *Thermoelectric Energy Harvesting: Basic Principles and Applications*. 10.5772/intechopen.83495.

²⁷ Gyselinckx, Bert & Van Hoof, Chris & Ryckaert, J. & Yazicioglu, Refet & Fiorini, Paolo & Leonov, V. (2005). Human++: Autonomous Wireless Sensors for Body Area Networks. 13 - 19. 10.1109/CICC.2005.1568597.

²⁸ Yu, Shuhai, et al. "Start-up modes of thermoelectric generator based on vehicle exhaust waste heat recovery." *Applied Energy* 138 (2015): 276-290.

²⁹ Electrical Power. (n.d.). Retrieved November 01, 2020, from <https://mars.nasa.gov/mars2020/spacecraft/rover/electrical-power/>.

Another exciting heat-recovery application is a hybrid solution to the photovoltaic system, where a combination of solar cells and TEGs increases the overall electrical efficiency. The results showed an increase in the combined photovoltaic and thermoelectric system's overall efficiency of 14.3%^[30]. Other studies have shown similar outcomes.

Commercial Products: Standard TEG plate-type products are available from several companies, including Thermoelectric Conversion Systems (TCS)^[31] and TE Technology^[32], while II-VI^[33] provides a range of different TEG configurations to fit with different operating environments.

1.1.4. Energy Harvesting from Electrical Power Lines

Author: Michail E. Kiziroglou

Principle of Operation: In some industrial and infrastructure sensor locations, the available environmental energy includes an alternating current (AC) electric and magnetic field induced by passing electrical power lines. Subject to installation restrictions, a transducer can couple inductively or capacitively to the power line by wrapping a secondary coil around it or placing an electrode in close vicinity to it, respectively.

Overview of Methods: The electric field can be exploited by installing a capacitor structure, such that the field gradient creates a voltage difference between two conductive plates. Charge tends to flow in and out of the capacitor plates as the field alternates. Current can be supplied to a connected electrical load and energy is transduced from the power line voltage to a local circuit to drive a local microsystem. This approach does not require a power line current as it relies on voltage, but the power line ground conductor/plane is crucial because it defines the electric field value for a given power line voltage. Several studies have been reported, mainly on high voltage grid transmission lines. In one^[34], a power output of 16 mW from a 60 kV / 50 Hz power line is reported, harvested by a 0.1 m diameter, 0.2 m long tube device installed on a real grid line. In another design^[35], a device of similar scale provides 23 mW from a laboratory 12.7 kV / 50 Hz line. In another example^[36], an energy autonomous, non-invasive voltage meter is based on electrical field harvesting. A comparison of various implementations can be found in industry papers^[37]. As the electric field strength is key to this type of energy harvesting, use cases involving high voltage and short line-to-ground distance are likely to be favorable applications.

The magnetic field can be exploited inductively using a coil. The induced voltage is proportional to the flux change rate and therefore power coupling increases with the number of coil turns, magnetic flux density, coil frame area, and power line current frequency. This transducer is effectively a current transformer, but with a design objective different from associated sensing devices or classical power transformers, because maximum power delivery is the priority over sensitivity, linearity, or efficiency. To increase the magnetic flux density for a given power line, bow-tie structures have been used^[38], achieving a power output of 0.61 mW from a 290 cm³ device from a field of just 7 μ T RMS at 50 Hz, while a flux guiding technique delivering 1.5 W from a 100 A RMS, 60 Hz power line field, using a 95 cm³ device was reported^[39]. A design optimization technique for coil-and-core receivers was

³⁰ Li, Guiqiang, et al. "Preliminary experiment on a novel photovoltaic-thermoelectric system in summer." *Energy* 188 (2019): 116041.

³¹ <https://www.teconversion.com>.

³² <https://tetech.com>.

³³ <https://ii-vi.com>.

³⁴ X. Zhao, T. Keutel, M. Baldauf, and O. Kanoun, "Energy harvesting for a wireless-monitoring system of overhead high-voltage power lines," *IET Generation, Transmission & Distribution*, vol. 7, no. 2, pp. 101-107, 2013.

³⁵ J. C. Rodriguez, D. G. Holmes, B. McGrath, and R. H. Wilkinson, "A Self-Triggered Pulsed-Mode Flyback Converter for Electric-Field Energy Harvesting," *IEEE Journal of Emerging and Selected Topics in Power Electronics*, vol. 6, no. 1, pp. 377-386, Mar 2018.

³⁶ S. Kang, S. Yang, and H. Kim, "Non-intrusive voltage measurement of ac power lines for smart grid system based on electric field energy harvesting," *Electronics Letters*, vol. 53, no. 3, Feb 2017.

³⁷ O. Cetinkaya and O. B. Akan, "Electric-Field Energy Harvesting from Lighting Elements for Battery-Less Internet of Things," in *IEEE Access*, vol. 5, pp. 7423-7434, 2017.

³⁸ S. Yuan, Y. Huang, J. Zhou, Q. Xu, C. Song, and G. Yuan, "A High-Efficiency Helical Core for Magnetic Field Energy Harvesting," *IEEE Transactions on Power Electronics*, vol. 32, no. 7, pp. 5365-5376, 2017.

³⁹ R. M. White, D. S. Nguyen, Z. Wu, and P. K. Wright, "Atmospheric Sensors and Energy Harvesters on Overhead Power Lines," *Sensors (Basel)*, vol. 18, no. 1, Jan 3 2018.

introduced^[40,41], including flux funneling soft magnetic core shapes, which can improve power density by a factor equal to the square of the funneling aspect ratio. Other promising techniques include the employment of high permeability materials for flux concentration and saturation control^[42].

Electromechanical coupling is also possible, by exploiting the field force to excite a mechanical beam, using a magnetic proof mass. The beam motion is in turn transduced into electricity, typically by the piezoelectric effect. The electromechanical approach offers electrical isolation and protection of the secondary circuit, at the expense of an additional intermediate energy transduction step. For constant power line frequency, the beam can be designed to operate at resonance, thereby minimizing losses. This method was introduced by demonstrating 0.35 mW from a 13 A RMS 60 Hz current, using a 0.26 cm³ piezoelectric beam^[43]. In another case, a 2.5 cm³ beam with a Halbach magnet array was used to achieve a stronger field and 0.52 mW from a 5 A RMS, 50 Hz current was reported^[44].

Outlook: A summary of performance from representative research prototypes for power-line energy harvesting is presented in Table 2. The power and power density output depends strongly on application conditions and installation; therefore a direct comparison of methods is not recommended. However, all works resulted in adequate power output for supporting the intended wireless sensor node use case. An example power supply prototype for aircraft structural^[45] current monitoring sensor nodes is illustrated in Figure 3.

Table 2 Overview of Power Line Energy Harvesting

<i>Paper</i>	<i>Method</i>	<i>Source Line (RMS)</i>	<i>P (mW)</i>	<i>P_V (mW/cm³)</i>
<i>Leland 2006^[43]</i>	<i>Piezo-beam & magnet</i>	<i>13 A, 60 Hz Bipolar</i>	<i>0.35</i>	<i>1.3</i>
<i>Zhao 2013^[34]</i>	<i>Electric field, capacitive</i>	<i>60 kV, 50 Hz</i>	<i>16</i>	<i>0.01</i>
<i>Toh 2014^[36]</i>	<i>Tuned coil</i>	<i>0.9 A, 620 Hz</i>	<i>2.9</i>	<i>0.65</i>
<i>He 201^[44]</i>	<i>Piezo-beam & Halbach array</i>	<i>5 A, 50 Hz Bipolar</i>	<i>0.52</i>	<i>0.21</i>
<i>Yuan 2017^[38]</i>	<i>Bow-tie & helical core</i>	<i>7 μT, 50 Hz</i>	<i>0.61</i>	<i>0.002</i>
<i>White 2018^[39]</i>	<i>Flux Guidance</i>	<i>100 A, 60 Hz</i>	<i>1500</i>	<i>16</i>
<i>Kiziroglou 2020^[45]</i>	<i>Tuned coil, flux funneling</i>	<i>25 A, 360 Hz Structural</i>	<i>0.70</i>	<i>0.37</i>

Note: P and P_V denote output power and power density per volume.

⁴⁰ M. E. Kiziroglou, S. W. Wright, and E. M. Yeatman, "Coil and core design for inductive energy receivers," *Sensors and Actuators A: Physical*, vol. 313, p. 112206, 2020/10/01/ 2020.

⁴¹ S. W. Wright, M. E. Kiziroglou, S. Spasic, N. Radosevic, and E. M. Yeatman, "Inductive Energy Harvesting from Current-Carrying Structures," *IEEE Sensors Letters*, vol. 3, no. 6, pp. 1-4, 2019.

⁴² Y. Zhuang et al., "Improving Current Transformer-Based Energy Extraction from AC Power Lines by Manipulating Magnetic Field," *IEEE Transactions on Industrial Electronics*, vol. 67, no. 11, pp. 9471-9479, Nov 2020.

⁴³ E. S. Leland, R. M. White, and P. Wright, "Energy scavenging power sources for household electrical monitoring," in *PowerMEMS*, Berkeley, U.S.A., 2006.

⁴⁴ W. He, P. Li, Y. M. Wen, J. T. Zhang, A. C. Yang, and C. J. Lu, "A Noncontact Magnetolectric Generator for Energy Harvesting from Power Lines," *IEEE Transactions on Magnetics*, vol. 50, no. 11, Nov 2014, Art. no. 8204604.

⁴⁵ M. E. Kiziroglou, S. W. Wright, and E. M. Yeatman, "Power Supply based on Inductive Harvesting from Structural Currents," Submitted, Under Review, 2021.

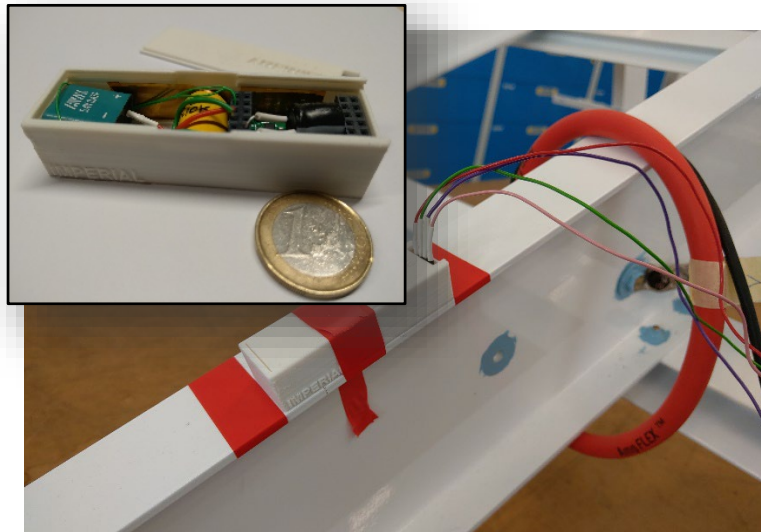

Figure 3 — Structural Current Power Supply Under Test on Industrial Aircraft Beam^[45]
(open-lid view reveals the H-shaped flux funneling soft core, power management, and storage components in inset)

In conclusion, power-line harvesting can currently offer power supply in the mW range by developing customized solutions suitable for specific environmental conditions. It is promising for applications involving sensing along overhead and underground power lines, industrial infrastructure, as well as vehicle sensing, where structured power supply networks are deployed. In addition, this technology offers a non-invasive method for coupling to existing powering infrastructure, for sensing as well as local powering applications.

1.1.5. Radio Frequency and Wireless Power Transfer (WPT)

Author: Roberto LaRosa

Radio Frequency (RF) energy harvesting is the extraction of energy from RF antennas included in devices such as mobile phones, laptops, etc. where the main function of the antenna is to provide a communications link rather than a power link. The amount of RF energy that can be harvested depends on many parameters, including transmitted power, the gain of the receiving and transmitting antenna, the frequency of the transmitted RF signal, the distance between the RF transmitter and receiver, and the power conversion efficiency (PCE) of the RF harvester. In free space, the RF power available at the antenna terminals of the RF harvester can be calculated with the following equation for Friis transmission^[46]:

$$P_A = P_T \frac{G_T G_R \lambda^2}{(4\pi d)^2}$$

where P_A is the available power at the power receiver, P_T is the transmitted power, G_T the transmitting antenna gain, G_R the receiver antenna gain, λ the wavelength, and d the distance between receiver and transmitter antenna.

For typical power transmission frequencies of 900 MHz and 2.4 GHz in free space, the transmitted power decays by -30 dB (1/1000) and -40 dB (1/10000), respectively, after a distance of only 1 m and continues decaying -20 dB every ten meters^[46]. Considering a distance of two meters between the transmitter and receiver in free space conditions, a transmitted power of 0.5 W (27 dBm) at a frequency of 900 MHz and gain of 1 for both antennas ($G_T = G_R = 1$), the received power equals 88 μ W (\approx -10.5 dBm). Modern designs of RF harvesters can achieve up to 50% of PCE; with this performance, the power delivered to the battery (P_{bat}) is 44 μ W. This performance reveals that RF energy scavenging, as of today, is not actually feasible and proper use of RF energy consists of over-the-distance wireless power transfer or directed energy harvesting.

⁴⁶ H. T. Friis, "A note on a simple transmission formula," *Proceedings of the IRE*, vol. 34, no. 5, pp. 254–256, 1946.

Wireless Power Transfer (WPT) Applications: The pervasiveness of RF energy enables the possibility to be conveniently transferred to devices that are out of reach or in hazardous places and must be wireless, maintenance-free, and sufficiently low in cost to promote their use almost anywhere. RF WPT has been proven to be a feasible, convenient, and successful way to energize wireless devices in several scientific publications. For example, proposed to exploit the pervasiveness of RF energy to charge the batteries over a distance of up to 170 cm by means of RF WPT^[47]. RF WPT can be very useful to wipe out the limitation of system lifetime caused by batteries and render wireless sensors non-disposable, more cost-efficient and functional as long as RF power is delivered^[48]. Battery-less wireless nodes embedded in concrete structures can ensure a maintenance-free life cycle^[49]. An innovative energy management platform is based on a 2.5 μ W ultra-low-power system on chip (SoC)^[50]. The SoC has been conceived as a novel modular system architecture and distinguishes itself as a very versatile platform for RF WPT that can be used to implement, with minimal effort, many practical use cases in real scenarios. A system for identifying and monitoring the speed of assets tracked with battery-less tags that receive all their operating energy through RF WPT provides a unique measurement approach to generate time-domain speed readouts^[51]. A battery-less railway monitoring system based on RF WPT to detect early defects on rail tracks was designed^[52]. Another example contributes to the state-of-the-art with an energy-autonomous platform for power measurement in RF environments^[53].

In a more indirect application of WPT, it is revealed how a significant reduction in battery power consumption can be achieved by eliminating standby power consumption^[1]. Even if the power consumption of the electrical appliances in standby can be quite low; in the majority of the use cases, power management circuits continue consuming energy unnecessarily for a long time, resulting in non-negligible energy consumption. To avoid this, an approach is proposed where appliances are effectively turned off rather than staying in standby, and are remotely woken up by RF WPT. Even after nullifying standby power consumption, batteries are eventually be drained.

1.1.6. Acoustic

Author: Akshayaa Pandiyan

Principle of Operation: Acoustic energy is principally mechanical vibrations transmitted in a medium as a pressure wave. When a transducer is positioned along the acoustic wave path and coupled to this medium, it can convert the motion caused by a sound wave into electrical energy.

Overview of Methods: A typical Acoustic Energy Harvester (AEH) consists of a sound pressure amplifier (to resonate the incoming waves), a conversion membrane (to convert sound to electrical energy), and a conditioning circuit (to process the output before powering the application)^[46]. A general summary of the sub-systems of an acoustic energy harvester is shown in Figure 4. For energy harvesting, audio waves in the audible frequency range (20 Hz – 20 kHz) or low frequency (<500 Hz) is preferred as they are less susceptible to noise and absorptive losses^[54].

⁴⁷ R. L. Rosa, G. Zoppi, A. Finocchiaro, G. Papotto, L. D. Donato, G. Sorbello, F. Bellomo, C. A. D. Carlo, and P. Livreri, "An over-the distance wireless battery charger based on RF energy harvesting," in 2017 14th International Conference on Synthesis, Modelling, Analysis and Simulation Methods and Applications to Circuit Design (SMACD). IEEE, 2017, pp. 1–4.

⁴⁸ R. La Rosa, C. Trigona, G. Zoppi, C. Di Carlo, L. Di Donato, and G. Sorbello, "RF energy scavenger for battery-free wireless sensor nodes," in 2018 IEEE International Instrumentation and Measurement Technology Conference (I2MTC). IEEE, 2018, pp. 1–5.

⁴⁹ G. Castorina, L. Di Donato, A. F. Morabito, T. Isernia, and G. Sorbello, "Analysis and design of a concrete embedded antenna for wireless monitoring applications [antenna applications corner]," *IEEE Antennas and Propagation Magazine*, vol. 58, no. 6, pp. 76–93, 2016.

⁵⁰ R. La Rosa, P. Livreri, C. Trigona, L. Di Donato, and G. Sorbello, "Strategies and techniques for powering wireless sensor nodes through energy harvesting and wireless power transfer," *Sensors*, vol. 19, no. 12, 2019. <https://www.mdpi.com/1424-8220/19/12/2660>.

⁵¹ R. La Rosa, C. Dehollain, and P. Livreri, "Advanced monitoring systems based on battery-less asset tracking modules energized through rf wireless power transfer," *Sensors*, vol. 20, no. 11, p. 3020, 2020.

⁵² P. Li, Z. Long, and Z. Yang, "Rf energy harvesting for battery-less and maintenance-free condition monitoring of railway tracks," *IEEE Internet of Things Journal*, 2020.

⁵³ R. La Rosa and C. Trigona, "A fully autonomous platform for power measurement of environmental RF sources based on a time domain readout," *Measurement*, vol. 165, p. 108115, 2020.

⁵⁴ R. La Rosa, N. Aiello, and G. Zoppi, "RF remotely-powered integrated system to nullify standby power consumption in electrical appliances," in Industrial Electronics Society, IECON 2016-42nd Annual Conference of the IEEE. IEEE, 2016, pp. 1162–1164.

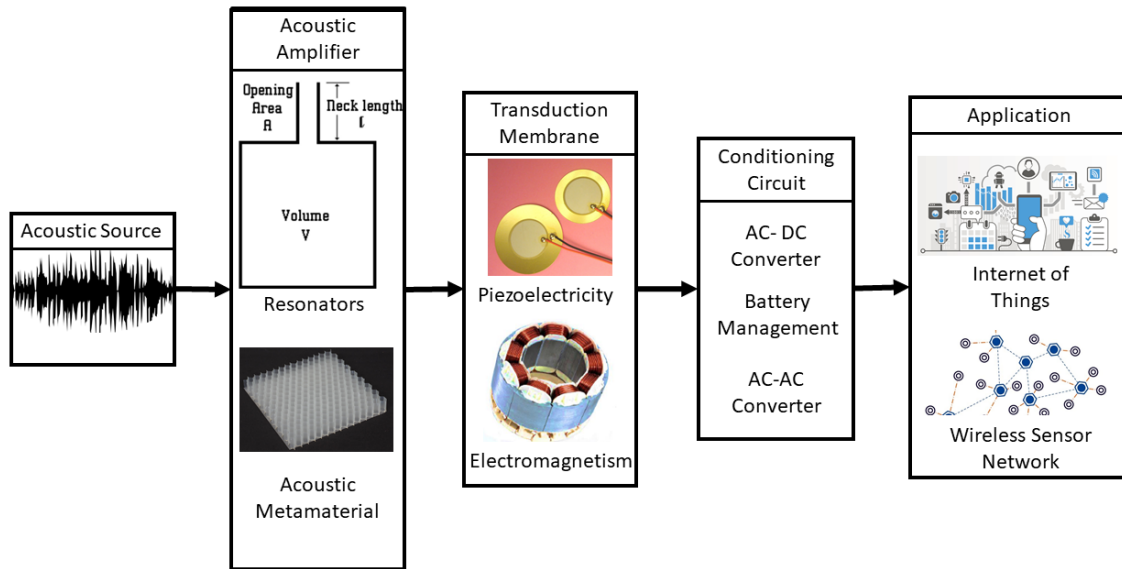

Figure 4 — Subsystem Summary of Typical Acoustic Energy Harvester

The power generated by an AEH depends on the Sound Pressure Level (SPL) of the source signal on the conversion membrane. Typically, the SPL of an ambient source is up to 100 dB (or 2 Pa), which is not sufficient to excite small-scale structures. Therefore, the ambient sound is passed through a resonator structure to amplify the SPL. This also eliminates undesired harmonics in the source wave. The Helmholtz resonator, which is the most utilized amplifier for AEHs, is comprised of a sound chamber with a minute cavity on top that makes the neck of the resonator. Its operation is similar to an oscillator, such as a mass-spring system. The amplified source wave in the chamber is then converted to electrical energy by an active membrane in the backplate, such as a piezoelectric layer. This energy harvesting device is called a tunable electromechanical Helmholtz resonator (EMHR).

Horowitz et al. modelled and designed an AEH with EMHR and experimentally demonstrated a $0.34 \mu\text{W}/\text{cm}^2$ energy density Micro-Electro-Mechanical System (MEMS) AEH using 149 dB SPL^[55]. Later, an improvised fabrication method projected an increased energy density of the same device to $252 \mu\text{W}/\text{cm}^2$. Besides piezoelectricity, many researchers have implemented devices based on electromagnetic transduction to harness acoustic energy by placing a temporary or permanent magnet on a flexible membrane near a coil^[56]. Both piezoelectricity and electromagnetic principles were used in an AEH by replacing the flexible membrane with Lead Zirconate Titanate (PZT)^[57]. In addition, Triboelectricity has also been used in some research for AEH^[58].

Besides Helmholtz resonators, tube resonators are also widely used for AEHs^[59]. There are two types of tube resonators: Quarter Wave Tube Resonators (QWTR), which have one end open and another end closed (this approach corresponds to a straight Helmholtz resonator with the same diameter for neck and cavity), and Half Wave Tube Resonators (HWTR), which have both ends open. They are typically used to characterize AEH devices, with the acoustic source on one end and the AEH on the other. Schematics of the different resonator types are illustrated in Figure 5. Additionally, some researchers have used micro-fabrication methods to grow sonic crystal pillar lattice to guide the acoustic wave toward the center. In this way, the SPL is amplified by the superposition of the acoustic

⁵⁵ S. B. Horowitz, M. Sheplak, L. N. Cattafesta, and T. Nishida, "A MEMS acoustic energy harvester," *Journal of Micromechanics and Microengineering*, vol. 16, no. 9, pp. S174-S181, 2006/08/09 2006, doi: 10.1088/0960-1317/16/9/s02.

⁵⁶ F. U. Khan and E. Izhar, "Acoustic-based electrodynamic energy harvester for wireless sensor nodes application," *Int. J. Mater. Sci. Eng.*, vol. 1, no. 2, pp. 72-78, 2013.

⁵⁷ F. U. Khan and Izhar, "Hybrid acoustic energy harvesting using combined electromagnetic and piezoelectric conversion," *Review of Scientific Instruments*, vol. 87, no. 2, p. 025003, 2016, doi: 10.1063/1.4941840.

⁵⁸ F. Chen et al., "A novel triboelectric nanogenerator based on electrospun polyvinylidene fluoride nanofibers for effective acoustic energy harvesting and self-powered multifunctional sensing," *Nano Energy*, vol. 56, pp. 241-251, 2019/02/01/ 2019, doi: <https://doi.org/10.1016/j.nanoen.2018.11.041>.

⁵⁹ N. M. Monroe and J. H. Lang, "Broadband, large scale acoustic energy harvesting via synthesized electrical load: I. Harvester design and model," *Smart Materials and Structures*, vol. 28, no. 5, p. 055032, 2019/04/18 2019, doi: 10.1088/1361-665x/ab114a.

wave received at the lattice center. Yang et al. coupled sonic crystals with a Helmholtz resonator to obtain an enhanced output of 429 μW from a 110 dB source, demonstrating a power density of 1.5 $\mu\text{W}/\text{cm}^2$ ^[60].

Despite the extensive research on AEH over the past decade, commercial devices are yet to be marketed for real-world applications. An AEH for powering commercial data loggers from generated aeroacoustics noise waves has been designed, but one design limitation of AEH is the high dependence on the resonant frequency of the active element and therefore is application specific. To overcome this, developing high-throughput Piezoelectric Micromachined Ultrasonic Transducers (PMUT) for energy harvesting applications would be a good alternative. PMUTS are compatible with MEMS devices and have a high sensitivity and bandwidth^[61]. Given the high frequency, these devices can also be acoustically matched with different media, such as air and water, manageably.

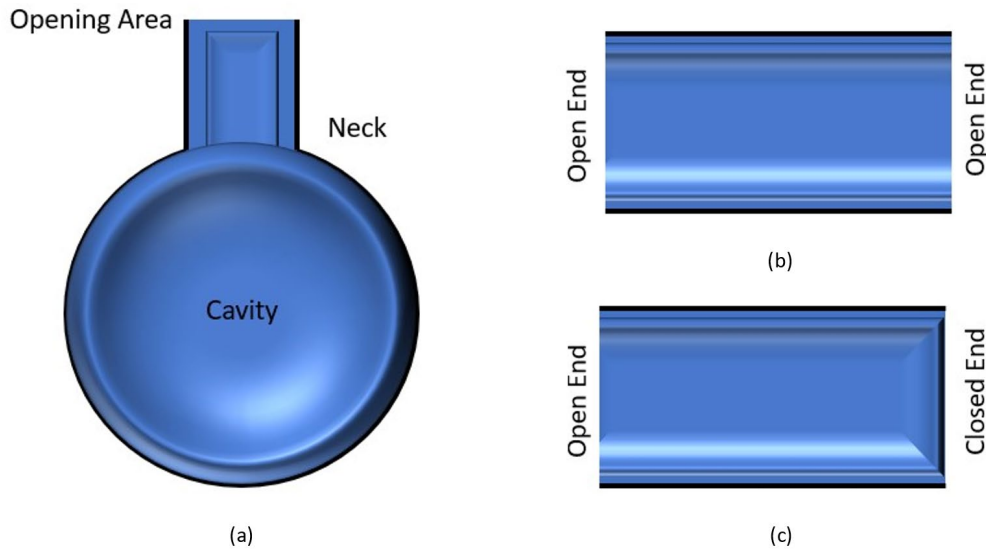

Figure 5 — Schematic of (a) Helmholtz Resonator (b) Quarter-Wave Tube Resonator (c) Half-Wave Tube Resonator

A brief summary of AEH research results is presented in Table 3 .

Table 3 Acoustic Energy Harvesting Power Levels Demonstrated by State-of-Art Methods

Reference	Amplifier Type	Energy Conversion	Device Size[cm^2]	Source SPL [dB]	Load Resistance [k Ω]	Output Power[μW]	Resonant Frequency[Hz]
[62]	EMHR	PZT	7.38	160	20	30000	2646
[61]	PMMA Crystals	PVDF	306.25	45	3.9	0.04	4200
[63]	EMHR	Dual PZT	3972.22	100	38	1430	201
[64]	Auxetic Resonators	PZT-5H	640	100	-	44(RMS)	107
[65]	Acoustic metamaterial	PZT	3	100	-	8.8	2257.5

⁶⁰ A. Yang et al., "Enhanced Acoustic Energy Harvesting Using Coupled Resonance Structure of Sonic Crystal and Helmholtz Resonator," *Applied Physics Express*, vol. 6, no. 12, p. 127101, 2013/12/01 2013, doi: 10.7567/apex.6.127101.

⁶¹ A. Guedes, S. Shelton, R. Przybyla, I. Izyumin, B. Boser, and D. A. Horsley, "Aluminum nitride pMUT based on a flexurally-suspended membrane," in 2011 16th International Solid-State Sensors, Actuators and Microsystems Conference, 5-9 June 2011, pp. 2062-2065, doi: 10.1109/TRANSDUCERS.2011.5969223.

⁶² R. Monthéard et al., "Powering a Commercial Datalogger by Energy Harvesting from Generated Aeroacoustic Noise," *Journal of Physics: Conference Series*, vol. 557, p. 012025, 2014/11/27 2014, doi: 10.1088/1742-6596/557/1/012025.

⁶³ F. Liu et al., "Acoustic energy harvesting using an electromechanical Helmholtz resonator," *The Journal of the Acoustical Society of America*, vol. 123, no. 4, pp. 1983-1990, 2008/04/01 2008, doi: 10.1121/1.2839000.

⁶⁴ L.-Y. Wu, L.-W. Chen, and C.-M. Liu, "Acoustic energy harvesting using resonant cavity of a sonic crystal," *Applied Physics Letters*, vol. 95, no. 1, p. 013506, 2009, doi: 10.1063/1.3176019.

⁶⁵ A. Yang et al., "Note: High-efficiency broadband acoustic energy harvesting using Helmholtz resonator and dual piezoelectric cantilever beams," *Review of Scientific Instruments*, vol. 85, no. 6, p. 066103, 2014, doi: 10.1063/1.4882316.

<i>Reference</i>	<i>Amplifier Type</i>	<i>Energy Conversion</i>	<i>Device Size[cm²]</i>	<i>Source SPL [dB]</i>	<i>Load Resistance [kΩ]</i>	<i>Output Power[μW]</i>	<i>Resonant Frequency[Hz]</i>
[66]	<i>Helix structure Resonator</i>	<i>PZT-5H</i>	251	100	11	7.3	183
[67]	<i>Wide-Band Coupled Helmholtz resonators</i>	<i>Piezoelectric Composite Sheet (PCS)</i>	4	160	-	40000	620
[68]	<i>Helmholtz Resonator</i>	<i>Triboelectric</i>	570	110	6000	376	240

1.2. Energy Storage

Energy harvesting sources only operate when there is sufficient ambient energy available; therefore their operation is generally intermittent, variable (e.g. according to indoor lighting schedules for PV sources), and/or cannot be controlled (e.g. current level flowing in an electrical cable). On the other hand, wireless sensors are expected to operate continuously and autonomously regardless of the environment in which they are located. To ensure continuous sensor operation, most EH systems are designed to harvest and store sufficient ambient energy when it is available so that sensor operation continues even when there is no ambient energy available. The required energy storage components range from batteries, which maintain sensor operation over long periods of source intermittency (e.g. overnight hours for PV systems), to ultra-capacitors (also known as supercapacitors) used for shorter intermittent timeframes (e.g. minutes) or when large energy pulses are required to support energy intensive sensors or long-range communications.

1.2.1. Batteries

Author: James Rohan

Batteries are the most common energy source for WSN currently. They exhibit limited capacities and lifetimes that have maintenance schedules measured in months rather than years. The frequent device intervention negates many advantages of wireless sensing. An alternative route to decrease the device intervention frequency is to provide energy that can be replenished daily at reasonable cost and with an appropriate device footprint. Systems with long-life batteries that do not require replacement over a 10 year+ timeframe are highly desirable.

Current energy intensive wireless sensor systems rely on primary (non-rechargeable) batteries. The capacity of the battery is chosen based on the measurement frequency and resulting energy requirements of the WSN. The data in 0shows the capacity vs. measurement frequency required to power a sensor that requires a pulse of approximately 50 mA for up to 100 ms for data collection and transmission, such as for CO₂ sensing. It can be seen that a daily capacity of 0.5 to 2.5 mAh or for ten years of operation between 1.8 and 9 Ah are required from the battery.

⁶⁶ P. Eghbali, D. Younesian, and S. Farhangdoust, "Enhancement of the low-frequency acoustic energy harvesting with auxetic resonators," *Applied Energy*, vol. 270, p. 115217, 2020/07/15/ 2020, doi: <https://doi.org/10.1016/j.apenergy.2020.115217>.

⁶⁷ S. Qi, M. Oudich, Y. Li, and B. Assouar, "Acoustic energy harvesting based on a planar acoustic metamaterial," *Applied Physics Letters*, vol. 108, no. 26, p. 263501, 2016, doi: 10.1063/1.4954987.

⁶⁸ M. Yuan, Z. Cao, J. Luo, and Z. Pang, "Helix structure for low frequency acoustic energy harvesting," *Review of Scientific Instruments*, vol. 89, no. 5, p. 055002, 2018, doi: 10.1063/1.5021526.

Table 4 Storage Capacity Required for a WSN Delivering 50 mA Pulses for 100 ms (Standby Capacity of 20 mAh Required) for a Range of Sensor Operational Frequencies*

<i>Measurement Frequency (Per hr)</i>	<i>Capacity / Day (mAh)</i>	<i>Capacity / 10 Years (mAh)</i>
<i>Standby only</i>	<i>0.48</i>	<i>1,752</i>
<i>1</i>	<i>0.51</i>	<i>1,874</i>
<i>4</i>	<i>0.61</i>	<i>2,238</i>
<i>12</i>	<i>0.88</i>	<i>3,212</i>
<i>30</i>	<i>1.48</i>	<i>5,402</i>
<i>60</i>	<i>2.48</i>	<i>9,052</i>

*No correction has been included for such issues as self-discharge or other forms of capacity loss over the device lifetime.

Materials: There are many battery chemistries and cell dimensions that can meet the energy requirements at face value, but other issues must be addressed to achieve an appropriate energy source. Primary alkaline- or lithium-based batteries are available that can match the capacity requirement for a ten-year device lifetime, particularly if connected in parallel. However, the high current pulse requirements and the associated capacity fade typically result in significantly less energy availability than the cell rating. A comparison of some of the most common primary battery types and their capabilities are listed in Table 5.

Table 5 Typical Primary Battery Characteristics

	<i>Potential (V)</i>	<i>Capacity (mAh)</i>	<i>Volume (cm³)</i>
<i>AA Zinc carbon (Zn/MnO₂)</i>	<i>1.5</i>	<i>1100</i>	<i>8.3</i>
<i>AA Li/FeS₂</i>	<i>1.5</i>	<i>3000</i>	<i>8.3</i>
<i>Coin cell CR2450</i>	<i>3</i>	<i>600</i>	<i>2.2</i>
<i>Coin Cell LR44</i>	<i>3</i>	<i>105</i>	<i>0.27</i>

The ideal would be integrated energy harvesting technologies (EHT) and storage. Most EHT devices have power densities in the sub-mW range; however, sensor operation and data transmission / receipt usually require mA currents for ms timeframes. A significant issue for the rechargeable cells is the low current that the harvesting device can deliver to recharge the battery. Low capacity (single-digit mAh) cells that are matched to the output current of the EH source are better, as are those that are readily charged at a low current rate.

Table 6 Typical Secondary (Rechargeable) Battery Characteristics

	<i>Potential (V)</i>	<i>Capacity(mAh)</i>	<i>Volume (cm³)</i>
<i>AA NiMH</i>	<i>1.2</i>	<i>2600</i>	<i>8.3</i>
<i>Li Cylindrical 18650</i>	<i>3.7</i>	<i>2600</i>	<i>16.5</i>
<i>Li Coin CR2450</i>	<i>3.6</i>	<i>120</i>	<i>2.2</i>

Solid-state micro-batteries have a number of advantages appropriate for WSN energy needs. Thin-film micro-batteries can deliver 250 $\mu\text{Ah}/\text{cm}^2$ capacities for single-layer cells. Peak currents of 5 mA/cm² are possible with those devices for 0.5 ms pulses every second. Therefore, a 10 cm² thin-film solid-state battery could provide the 2.48 mAh daily capacity required for a WSN undergoing a 50 mA pulse for 100 ms every minute (see Table 6). They exhibit very long lifetimes, with 5,000+ cycles possible, particularly under conditions of shallow cell discharge. They have a stable output potential over the device lifetime. A trend emerging from solid-state micro-battery manufacturers is the production of stacked cells which could decrease the footprint required for a given capacity.

There are, however, a number of issues that require development. Being solid-state, the internal resistance of the cells can be up to 500 times higher than standard liquid electrolytes. This results in a potential drop of hundreds of mVs at high current drain for which the micro-power management

system must allow. In some cases, it may be more appropriate to integrate supercapacitors in the circuit that would provide the output for the short-term storage, supported by the long-term storage in the battery. Furthermore, large-area 2D cells of the same dimension as solar cells have not yet been produced commercially, though a number of companies driven by the desire to migrate EV batteries to the safer solid-state options are developing manufacturing capabilities to introduce large-area solid-state cells. For EVs, multilayer or stacked solid-state cells are essential to replace the incumbent liquid-based technology. This industry development will also assist with energy storage provision at lower power levels for wireless sensor nodes. In addition to the current manufacturing optimization for stacked cells, there is a continuous effort to improve the materials of the electrodes to utilize the most energy dense materials; such as lithium metal or silicon-based anodes, low- or no-cobalt based cathodes, and higher conductivity electrolytes for high power requirements. A wish list for the ideal energy storage options would include low-cost or abundant and high energy density electrode materials in combination with safe, non-flammable, and high-conductivity electrolytes that can be profitably recycled to address sustainability and environmental concerns.

Commercial Products: Several companies have developed solid-state batteries suitable for energy harvesting applications, including Ilika^[69] in the UK, who are developing their production facilities to enable stacked cells with a capacity of 1.5 mAh/cm². Other manufacturers active in the development and commercialization of thin-film micro-batteries include Cymbet^[70] and Front Edge Technology^[71].

1.2.2. Supercapacitors

Author: Maeve Duffy

While batteries provide very well-established energy storage solutions, their maximum rated output power levels are often lower than the peak power demanded by wireless sensor nodes, especially during data transmission. As a result, the battery capacity required to supply a wireless sensor may need to be increased significantly to deliver a high level of pulsed power, even though its energy capacity is sufficient to maintain the average power consumption of operating time. The combination of a battery with a supercapacitor (also known as electric double-layer capacitor (ELDC) or ultracapacitor) can be used to address this issue. Supercapacitors generally have higher power density than batteries, but with lower energy density, as shown in the Ragone chart of Figure 6. In a hybrid battery-supercapacitor storage solution, the high-power pulses are supplied by a supercapacitor, while the lower continuous power levels are supplied by a battery, resulting in a smaller overall size.

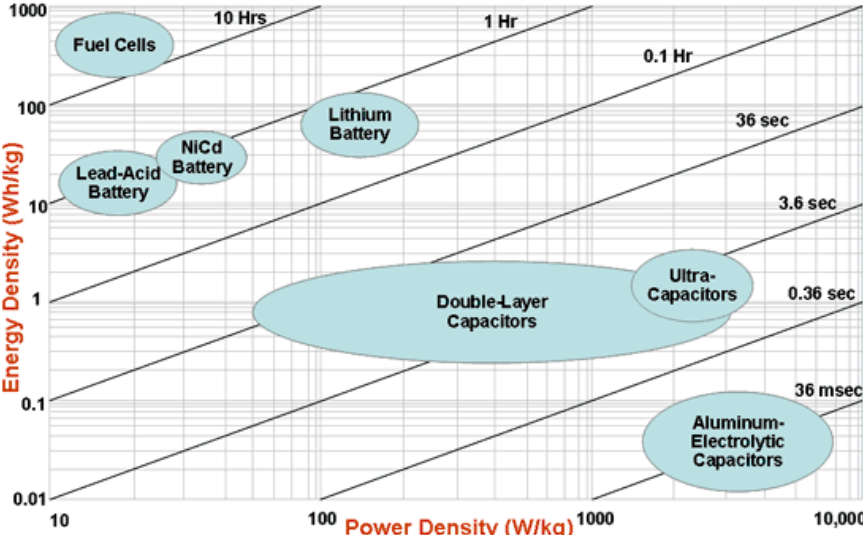

Source US Defence Logistics Agency

Figure 6 — Ragone Chart of Storage Devices^[72]

⁶⁹ www.ilika.com.

⁷⁰ www.cymbet.com.

⁷¹ www.frontedgetechnology.com.

⁷² Electropaedia, "Battery and energy technologies," 2005. <http://www.mpoweruk.com/performance.htm>.

Commercial Products: A sample range of commercial supercapacitors available to supply such pulsed power levels are listed in Table 7. Rated voltage levels range between 2.5 – 5.5 V, corresponding to standard battery operating voltages, while the component cost is inversely proportional to Effective Series Resistance (ESR).

Table 7 Characteristics of Suitable Supercapacitors for Pulsed Power Delivery for Wireless Sensors

Capacitance (F)	Manufacturer	Model Number	Voltage (V)	ESR (Ω)	Size (cm^3)	Cost	Ref
0.1	AVX	BZ155A1 04Z_B	5.5	0.15	1.83	\$\$\$	[73]
0.1	Eaton PowerStor	PB5R0H104 -R	5	5	0.74	\$\$	[74]
0.2	Eaton Powerstor	B0510- 2R5224- R	2.5	4	0.22	\$	[75]
0.2	Murata	GW202F	4.5	0.07	1.45	\$\$\$	[76]

Indeed, high ESR is one limitation of supercapacitors because it limits their charge/discharge efficiency. Nonetheless, supercapacitors have been successfully used in wireless sensor circuits to reduce the size of the battery needed to provide reliable data transmission. The combination of a battery and supercapacitor has also been shown to exploit the relative advantages of both for WSNs in hybrid energy storage solutions^[77,78].

1.3. Energy Harvesting Management

1.3.1. Micro-Power Management

Author: Peter Spies

The general principle in energy harvesting is to transform small amounts of ambient energy into electric energy and collect it until there is enough to power an action of an electronic microsystem. This electronic microsystem (such as a sensor, wireless radio module, or actuator) operates for the majority of time in a passive mode, where it only consumes a small amount of power $P_{Passive}$ (Figure 7), typically in the micro or nanowatt range. During actions like measuring a sensor value or transmitting a data telegram, the power consumption is much higher (P_{Active}), perhaps in the milliwatt range, for a short time. The average output from the harvesting system P_{AVG} must cover the passive power consumption and save excess power to cover the active power consumption during short actions, called bursts.

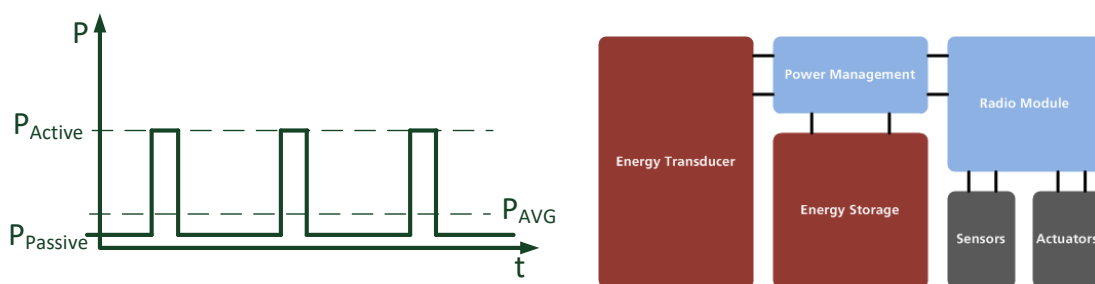

Figure 7— Operating Principle of Energy Harvesting Systems, Block Diagram of Energy Harvesting Systems

⁷³ AVX Corporation, “AVX BestCap® Ultra-low ESR BestCap Ultralow ESR,” 2017. <http://catalogs.avx.com/BestCap.pdf>.

⁷⁴ Eaton, PB Supercapacitor, 2017. <https://www.eaton.com/us/en-us/catalog/electronic-components/pb-supercapacitor.html>.

⁷⁵ Eaton, B Supercapacitors, 2017. <https://www.eaton.com/us/en-us/catalog/electronic-components/b-supercapacitor.html>.

⁷⁶ Murata, “DMT3N4R2U224M3DTA0/Supercapacitor (EDLC),” 2017.

<https://www.murata.com/enus/products/productdata/8797929537566/MFCDST2E.pdf?1513740609000>.

⁷⁷ Wensi Wang, Ningning Wang, Alessandro Vinco, Rashid Siddique, Mike Hayes, Brendan O’Flynn and Cian O’Mathuna “Super-capacitor and Thin Film Battery Hybrid Energy Storage for Energy Harvesting Applications”, *Journal of Physics: Conference Series*, Volume 476, The 13th International Conference on Micro and Nanotechnology for Power Generation and Energy Conversion Applications (PowerMEMS 2013) 3–6 December 2013, London, UK.

⁷⁸ Nanjian Qi, Yajiang Yin, Keren Dai, Chengjun Wu, Xiaofeng Wang, Zheng You, “Comprehensive optimized hybrid energy storage system for long-life solar-powered wireless sensor network nodes”, *Applied Energy*, Volume 290, 2021.

Since the voltage levels of available energy transducers and materials normally do not directly match the charge voltage of batteries or capacitors or the supply voltages of state-of-the-art electronics (e.g. 1.8 V, 3.3 V, 5 V_{DC}), voltage converters are used. These converters are located between the transducers and the storage and between the storage device and the load circuits, such as wireless modules or sensor devices. They are generally summarized as power management circuits. Because energy harvesting powered systems mainly process micro-watts, it is usually called micro power management. Since the generated power levels from the harvesters are typically quite low due to the small amounts of ambient energy and the limited energy conversion efficiency, the efficiency of the voltage converter is a critical performance parameter. For the same reason, another important parameter is the minimum power required to start the converter from complete shut-off, commonly called cold-start.

Nearly all harvesting principles and their related device materials have different requirements regarding the voltage converter used to achieve the best performance regarding power output and start-up behavior. According to the maximum power transfer theorem, the internal resistance of the harvesting transducer should match the input resistance of the voltage converter. This matching is achieved by the voltage converter, which determines its input impedance. With the help of regulation loops at the voltage converters, this matching can be controlled by changing the duty cycle or switching frequency during operation, called maximum power point tracking (MPPT).

Dc-Dc Voltage Converters: Since solar cells are on the market for a very long time, so are the required Dc-Dc converters to connect one or several cells with a dedicated storage device. The open-circuit voltage of a single solar cell is 0.5 V, so the minimum input voltage of commercially available converter products is around 350 mV. This enables an energy harvesting system start-up with a single cell. Typical efficiencies start at 30% for low input voltage levels and rise up to 90% for higher input voltage levels and increasing output current^[79,80].

Since the generated voltage level of thermoelectric generators can be as low as a couple of millivolts, taking into account typical Seebeck coefficients of 50 mV/K for TEG modules, the start-up voltage level is even more challenging here than for solar cells. There are some architectures that achieve a cold-start at 20 mV and even lower and efficiencies, between 30 and 80%, depending on the input to output voltage difference. Since thermoelectric generators change the direction of the current according to the thermal gradient, voltage converters for TEGs typically have a bipolar input stage. This is often realized with an internal switching architecture that detects and reverses the polarity of the incoming current^[81].

For adapting the voltage of the storage elements to the required level of the application circuit, such as radio modules, sensors, or actuators; several commercial Dc-Dc voltage converter types are available. A main difference between switching type regulators used for harvesters and linear regulators is that linear regulators, also called low-drop out (LDO) regulators, are mainly used for very light loads and small voltage differences since their efficiency is directly proportional to the load current and voltage difference between input and output. For all other cases, switching type regulators, such as buck or boost converters, are most efficient in this use. Charge pumps are a further option, mainly for very light loads and when negative voltages are required.

Ac-Dc Voltage Converters: If mechanical and vibration harvesters are used, periodically alternating signals (Ac) have to be processed, which typically requires an efficient rectifier as an input stage. Depending on the material and harvester principle, these can be built in principle with standard diodes. If piezoelectric elements with large excitations are used, high-voltage diodes are required to use the maximum voltage swing up to 100 V and harvest the maximum available power. However, these diodes regularly exhibit large parasitic leakage currents, making them less than ideal for efficient micro power management circuits. Apart from the standard architecture of a rectifier and a Dc-Dc converter as a second stage, there are numerous Ac-Dc architectures for piezoelectric materials

⁷⁹ E-Peas Semiconductor AEM10941 Highly-efficient, regulated dual-output, ambient energy manager for up to 7-cell solar panels with optional primary battery, 2018.

⁸⁰ Linear Technology LTC3105 400 mA Step-Up Dc-Dc, Converter with Maximum Power, Point Control and 250 mV Start-Up.

⁸¹ Harald Dillersberger, Bernd Deutschmann, Douglas Tham: A Bipolar 13 mV Self-Starting and 85% Peak Efficiency Dc-Dc Converter for Thermoelectric Energy Harvesting, *Energies* 2020, 13, 5501; doi:10.3390/en13205501, www.mdpi.com/journal/energies.

considering the special capacitive impedance of the piezoelectric transducer. Therefore, inductive input stages to achieve complex conjugate impedance matching are designed to achieve a maximum efficiency. Different approaches and implementation states can be found in literature^[82].

On the lower side of the voltage spectrum of vibration harvesters are inductive mechanical harvesters that often produce only alternating voltages below 1 V. These transducers require diodes with a voltage drop low enough to leave voltage for the Dc-Dc converter afterwards. To minimize this voltage drop, MOSFETs can be used instead of passive diodes. Due to the low voltage, a second stage Dc-Dc converter, as described above, may be required to further step up the voltage after the rectifier.

Alternatively, architectures are present that omit the rectifier stage to improve efficiency and lower start-up voltages. These bridgeless converters use a sophisticated combination of diodes and switches to achieve the rectification and conversion task in a single stage. There are even architectures and designs that use the internal inductance of an electro-dynamic generator as a switching element to reduce device count and board space of the Ac-Dc converter. Typical quiescent currents of as low as 250 nA with efficiencies up to 88% are achieved^[83,84].

Outlook: In summary, the main challenge in micro power management for energy harvesting is achieving reasonable energy efficiency between source and load due to the need for voltage conversion and regulation at low power. The second challenge is low cold-start power levels. Research is presently focused on the converters directly after the harvester, since commercial products are still lacking performance in terms of start-up voltage and efficiency. The harvester itself is often the highest cost and space intensive component. By improving the efficiency of the voltage converter, the harvester can be minimized without lowering power output, which results in decreased cost and board space of the whole system.

1.3.2. Functionality / Low Power Loads

Author: Oktay Cetinkaya

Considering the foreseen scale of emerging networks, such as the Internet of Things (IoT), it is imperative to reduce the cost and volume of wireless devices while ensuring flexible, maintenance-free, and environmentally friendly sensor operation. To achieve that, two main factors have to be well-understood: the capabilities and the potential of energy harvesters described above and the loads or the service requirements of devices.

It is often hard to run devices directly with an energy harvester (of size comparable to that of the devices). This might be due to a high impedance load or (mostly) the temporal variations in the EH output, as described in Section 1.3. In such cases, to minimize the dynamics of the EH and ensure reliable device operation; the devices are usually equipped with relatively large energy storage, e.g., a supercapacitor or a rechargeable battery, so the energy is accumulated when available and transferred to the device after exceeding a predefined threshold. This approach is commonly called energy-neutral operation, which aims to match the energy generation, $P_h(t)$, to the consumption, $P_c(t)$, over a time period, T ,:

$$\int_{(n-1)T}^{nT} P_h(t)dt = \int_{(n-1)T}^{nT} P_c(t)dt$$

The energy-neutral operation can achieve a high quality of service (QoS). Adding a large storage not only increases the device cost, weight, and volume; but also delays the start-up as it takes longer to charge the storage to the point when the device tasks can be executed.

⁸² Markus Pollak, Loreto Mateu, Peter Spies: Handbook of Energy Harvesting Power Supplies and Applications, Pan Stanford Publishing Pte Ltd, 2021.

⁸³ Phattharapol Choetchaia, Apinunt Thanachayanontb: A self-starting Ac-to-Dc step-up converter for energy harvesting, Applications, 2016 International Electrical Engineering Congress, IEECON2016, 2-4 March 2016, Chiang Mai, Thailand.

⁸⁴ Robin Bolt, Michele Magno, Thomas Burger, Aldo Romani, Luca Benin: Kinetic Ac-Dc Converter for Electromagnetic Energy Harvesting in Autonomous Wearable Devices, <https://www.researchgate.net/publication/321028530>.

By contrast, in power-neutral operation, the sensor load consumption, $P_c(t)$, is tuned to instantaneously match the generation, $P_h(t)$, to cope with the dynamics of the EH source:

$$P_c(t) = P_h(t)$$

This can eliminate the need for energy storage. However, the volatile system state cannot be preserved without storage when $P_h(t)$ drops below the minimum operation threshold, which is also the case for the long periods of no energy availability. Although the systems can switch to an ultra-low-power sleep mode to survive, the devices are eventually disabled if the EH output fails to provide the energy needed to stay in sleep mode. This results in the loss of system operation, forcing the devices to reboot and restart the application when power is restored. This can mean the loss of important data and delayed progress due to the interrupted execution. Despite being liberated from the storage-related drawbacks of the energy-neutral systems, the threatened reliability degrades the QoS in power-neutral operation, making it unsuitable for long-running applications.

As an alternative, intermittent or transient operation has emerged recently, which embraces that power outages can occur frequently (rather than trying to hide the dynamics of EH) and allows operations to span across the outages. It can support long-running applications by making incremental progress whenever the EH output is sufficient, while still minimizing the need for energy storage. The intermittent operation can, therefore, enable maintenance-free and theoretically unlimited operation cycle at very low cost and volume in an environmentally-friendly manner. Although the QoS is not as high as that of energy-neutral operation, it provides certain capabilities without intensifying especially the cost and volume issue under scarce EH conditions.

Depending on the control strategy, the intermittent operation offers static, task-based, and reactive schemes. In static schemes, snapshots of the system state for the transition to the next task are saved at predetermined checkpoints in the program. In task-based schemes, the application is divided into small tasks (e.g., sensing, processing, and transmission), which are executed atomically by a runtime, i.e., one power cycle. The snapshots are saved into a non-volatile memory (NVM) when a task is completed. In reactive schemes, the snapshots are saved when a power outage is likely to occur. The tasks are not necessarily performed in one cycle since they can be resumed after the power is restored thanks to the system state saved just before the outage. This splitting of task execution across consecutive power cycles minimizes the required storage size. However, reactive schemes are not suitable for tasks that cannot be split, such as sensing and transmission^[85], since they cause unreliability. Recent studies have focused on the energy-aware combination of task-based and reactive schemes to benefit from the capabilities of both schemes. This approach can offer significant benefits, such as preserved reliability at low cost and volume, while application execution is sustained at scarce energy availability by dynamically adjusting the system performance based on the EH output. The next efforts are expected to proceed in this direction while incorporating efficient timekeeping solutions.

⁸⁵ S. T. Sliper, O. Cetinkaya, A. S. Weddell, B. M. Al-Hashimi, and G. V. Merrett; "Energy-driven computing," *Philosophical Transactions of the Royal Society A*, vol. 378, no. 2164, pp. 20190158, Feb. 2020.

1.4. State-of-the-Art Summary

Author: Maeve Duffy

An overall comparison of the typical power levels available from the different energy harvesting sources considered is given in Table 8, where values are normalized with respect to area for sources that have a two-dimensional / planar format (e.g. PV panels, TEG plates), while normalization is with respect to volume for the more three-dimensional structures (e.g. electromagnetic). It is important to note that the power available is highly dependent on the environmental conditions applying in the test set-up, although the specified conditions are typical for the given energy sources when applied to supply IoT sensor loads.

Table 8 Comparison of Typical Power Levels Available from EH Sources

<i>Source Type</i>	<i>Principle / Materials</i>	<i>Output Power</i>
<i>Vibration</i>	<i>Electromagnetic</i>	<i>3.9 mW/cm³ at 1 G, 7 Hz BW</i>
<i>Photovoltaic (PV)</i>	<i>GaAs</i>	<i>26.1 μW/cm² at 77.40 μW/cm⁻² light, intensity MPP</i>
<i>Thermoelectric (TEG)</i>	<i>Aluminum oxide ceramic</i>	<i>232.5 mW/cm² at $\Delta T= 120^\circ$, MPP</i>
<i>Electrical power lines</i>	<i>Electromagnetic coupling</i>	<i>16 mW/cm³ at 100 A, 60 Hz line current</i>
<i>Acoustic</i>	<i>Coupled Helmholtz resonators</i>	<i>10 mW/cm² at 160 dB, 620 Hz</i>

2. Developing for a Use Case

Editor: Michail E. Kiziroglou

In this section, the development of energy harvesting solutions for particular industrial use cases is discussed. The first two subsections focus on considerations for negotiating specifications and on calculating the power and energy requirements. Subsequently, four use cases of airflow, thermal, solar, and RF energy harvesting are presented. These serve as examples of functional energy harvesting power supplies developed to address certain sensing applications defined by real industrial users.

2.1. Setting Specifications and Developing Solutions for a Use Case

Energy harvesting has reached the important milestone of providing integrated power supplies from most environmental energy sources in the last five years, at a technology readiness level of 5 or more. Progress on commercialization has been limited partly by slow progress in the deployment of wireless sensor networks, due to a conservative investment plan adopted by most industries in the last decade. In addition, the performance of energy harvesting relies on environmental conditions and functional demonstrators that have only recently reached power levels that match typical sensor demand are very sensitive to installation and environment details. In practice, this means that energy harvesting as an energy autonomy service is currently available only through the development of customized generator designs tailored to specific applications. While progress on transduction materials and techniques gradually increase the design margin, a number of applications can already benefit from energy autonomous wireless sensing through bespoke solutions developed by energy harvesting research and development institutions.

The adaptation of a customized energy harvesting based powering solution requires months of development and has a high initial cost, but it offers unique functional and environmental advantages, some of which can prove of strategic importance in the emerging Internet of Things landscape. In addition, it can also be financially beneficial in the short term in applications with large infrastructure and equipment maintenance costs. These current challenges and advantages of energy harvesting will be analyzed in sections three and four, respectively.

The adoption of a custom energy autonomy solution requires a series of directed development steps. These steps include:

- A. The identification of a set of known environmental conditions by the technology user.
- B. The definition of an energy and power budget required for the given application. This depends on the microsystem design, sensing, and communication techniques/protocols used.
- C. The selection of one or more environmental energy sources and a suitable transduction mechanism.
- D. The development of a custom transducer design and prototype, suitable for the size and installation limitations, as well as for the required average power demand.
- E. The development of a power management and energy storage system that can provide power in a form that meets voltage, power, quality, reliability, and energy demand as specified in B.
- F. Tests and adaptations toward a final product that can be deployed and offer the service desired.

2.2. Energy and Power Budgeting

In the technology customization process, the definition of energy and power income and consumption (Step B in Section 2.1) has a central role, as it lies between user specifications and system design. It is a multi-parameter problem, including environmental energy availability data such as vibration, temperature, and field profiles; installation conditions; size; and weight limitations that define the potential energy input. On the other hand, parameters including the desirable sensor, actuator and overall system operation scenarios define the energy consumption requirements.

In the case of wireless sensor nodes; sampling, processing, and transmission data rates and protocols define a sensing case, with specific operational duty cycling requirements for each subsystem. These allow calculation of the total energy or average power required for a given system function. In addition, the characteristics of expected power demand bursts can be used to calculate any power buffering requirements and include energy storage, in a battery or super-capacitor form, to address them. This includes both power-hungry modes of operation, where a higher power is required for a given duration, and the maximum power rating of the user system, which should be expected to occur in very short and unpredictable intervals. In this way, a certain use case can be translated into a set of values for energy, power, and storage and subsequently into an energy harvesting device size requirement. The result should be checked against the application's specified size restrictions. In most cases, a compromise between size and sensing case parameters is required. This design process is illustrated in Figure 8.

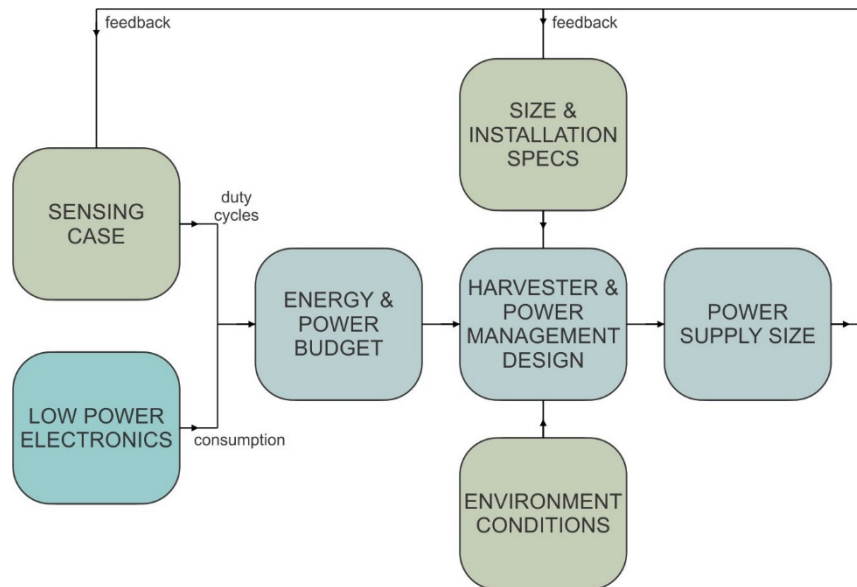

Figure 8 — Schematic of the Design Process for Custom Energy Harvesting Solutions

Overall, the strong link between environmental conditions, sensing scenarios, and energy harvesting device design offers space for a significant level of co-design and active technical collaboration between users and developers. This typically leads to pressure to compromise, which serves as a driver for system optimization on harvesting and sensing, as well as on low power electronics. Key recent or emerging system capabilities towards energy autonomous microsystems include threshold-activated sensing, cold-starting, dynamic duty cycling, sub-Nyquist sampling, remote turn-on, and energy-aware sensing. On the energy-harvesting side, the combination of energy harvesting, storage, and wireless power transfer is expected to provide significant support to the energy autonomy roadmap in the next two to five years.

In the following subsections, four sensing use cases addressed by air flow, solar, thermal, and RF energy harvesting are presented. They serve as examples of functional energy harvesting power supplies developed to address certain sensing applications defined by an industrial user.

2.3. Use Cases

2.3.1. Air Flow Energy Harvesting for Environmental Control in Buildings

Author: Andrew S. Holmes

Energy harvesting from fluid flows has received increasing attention over the past decade, although it still remains something of a niche. Energy harvesters that can extract power from airflow fall into two main categories: miniature wind turbines (MWTs) and devices based on flow-induced vibration (FIV). FIV devices can be further divided according to the particular mechanism involved. Vortex shedding devices exploit the oscillatory flow instabilities generated by a bluff body to drive the vibration of a mass-spring-damper system in which damping is due partly to an electrical transducer. Galloping

devices, on the other hand, rely on the fact that a (non-cylindrical) bluff body mounted on a compliant suspension will, under certain flow conditions, experience negative damping due to the interaction between the body motion and the airflow. Similar behavior, referred to as flutter, can be exhibited by compliant aerodynamic bodies (e.g. aerofoil on elastic suspension). Surveys of the work reported on all of these airflow harvester types have been published^[86,87].

Well-designed MWTs generally offer higher performance than FIV devices in terms of overall efficiency (output power divided by intercepted kinetic energy flux in flow), but are more complex in construction. Most importantly, they require bearings, making stable operation over long periods a challenge. Minimal bearing friction is essential if the MWT is to operate down to airflow speeds of a few m/s, which is a requirement in most applications. Vortex shedding devices can readily be designed to operate at low flow speeds, but their response is resonant and limited to a relatively narrow dynamic range. In contrast, devices based on galloping/flutter cover a broader flow speed range, but generally have higher minimum flow speeds. As with other areas of energy harvesting, the choice of technology depends on the application requirements. Typical performance values for devices are reported in industry literature^[87]. Centimeter-scale MWTs have been demonstrated with overall efficiencies up to ~10% and minimum flow speeds as low as 1.5 m/s, though these limiting values have not been demonstrated in the same device. The corresponding figures for FIV devices are ~3% and 0.9 m/s.

The mechanical power flow per unit area associated with a fluid of density ρ , flowing at speed U , is $\frac{1}{2}\rho U^3$, and the output power of an energy harvester placed in the flow may be expressed as:

$$P = \eta C_p \cdot \frac{1}{2} \rho U^3 A$$

where A is the cross-sectional area presented to the flow, C_p is the power coefficient, representing the fraction of the fluid power that is extracted as raw mechanical power, and η is the efficiency of the mechanical to electrical transduction. The product ηC_p is the overall efficiency of the harvester.

The overall efficiency values for all miniature airflow harvesters are low, primarily because of viscous losses. Nevertheless, useful levels of power can be generated at modest flow speeds. For example, a device with an area of 10 cm² and an overall efficiency of 5%, when placed in an airstream ($\rho = 1.2$ kg/m³), yields an output power of 3.75 mW at a flow speed of 5 m/s. This level of power could support low-duty-cycle sensing and wireless transmission in a range of applications.

One area where airflow energy harvesting could have significant impact is in environmental monitoring and control within buildings. According to the US Department of Energy (DoE)^[88], buildings account for ~40% of primary energy consumption in the US and, of this energy, ~43% is used for space heating and cooling (2015 data). Modern office buildings typically have HVAC (heating, ventilation, and air-conditioning) systems with multiple thermal zones that can be independently controlled. Significant reductions in energy consumption are possible if the control of each zone takes account of occupancy^[89]. In practice, most buildings are actually operated on a fixed occupancy schedule, which can be very inefficient in buildings where occupancy patterns are irregular.

Figure 9 shows how a typical HVAC system might be modified for occupancy-based control by the addition of wireless occupancy sensors (shown in red) powered by airflow at the HVAC ports/grilles in each zone. The environment in each zone is controlled by a dedicated variable air volume (VAV) box that controls the airflow into the zone, reheating the air as necessary. The VAV boxes and main air handling unit are connected to a central energy management system via a wired network and the additional occupancy sensors are given access to this network via base stations. An important feature of such a system upgrade is that it can be implemented with minimal capital expenditure. Figure 9 also shows a wireless sensor within the main HVAC duct; another important potential application for

⁸⁶ Nabavi S., Zhang L., "Portable wind energy harvesting for low-power applications: a survey", *Sensors*, vol. 16, s16071101, 2016.

⁸⁷ Holmes A.S., "Airflow energy harvesting", in *Energy Harvesting Technologies in Buildings*, Matiko J.W. and Beeby S.P. (eds.), Artech House, 2017, 30pp.

⁸⁸ DoE Buildings Energy Data Book, <https://openet.org/doe-opendata/dataset/buildings-energy-data-book>.

⁸⁹ Agarwal Y., Balaji B., Dutta S., Gupta R.K., Weng T., "Duty-cycling buildings aggressively: the next frontier in HVAC control", *Proc. IPSN* 2011, pp. 246-257, 2011.

airflow-powered sensors. Many existing HVAC systems would benefit from control based on information gathered by sensors distributed throughout the duct network. Such sensors could communicate via a peer-to-peer wireless network within the ducts, with re-radiating devices providing connection to the building wireless network.

The viability of the solution proposed in Figure 9 depends on sufficient airflow in the HVAC ducts and at the ports/grilles. Considering the duct sensors first; the flow speeds in the main ducts of a large building are typically in the range 5 to 12 m/s, which is compatible with many of the small-scale airflow harvesters that have been reported and allow useful levels of power (mWs) to be generated^[90]. The occupancy-sensing application is more challenging because the flow rates are lower, typically in the range 1.2 to 2.5 m/s^[90]. Several devices have demonstrated they can operate within this range. However, an important further consideration for occupancy sensors is aesthetic constraints on the size and form factor of the device if it is to be mounted on the outside of the HVAC grille. Most of the devices that meet the flow speed requirements are too large to be realistic contenders.

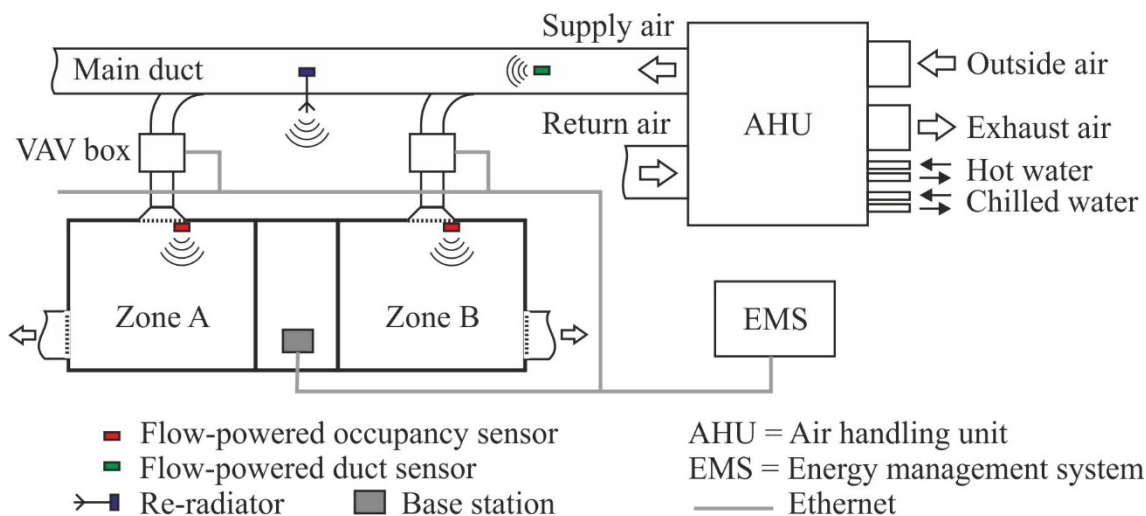

Figure 9 — Deployment of Airflow-Powered Room Occupancy and Duct Flow Wireless Sensors to Improve the Energy Efficiency of an HVAC System^[87] (image courtesy of Artech House)

Two examples of airflow energy harvesters developed specifically for HVAC applications are the vortex shedding device from UC Berkeley^[91] and the MWT from Imperial College^[92]. Both of these devices were aimed at HVAC duct sensing and both were designed to specifications informed by discussions with Siemens Building Technologies. Figure 10 (a) shows a photograph of the Imperial College device, comprised of a shrouded horizontal axis wind turbine with a permanent magnet generator integrated into the shroud. The rotor diameter is 2 cm and the overall cross-sectional area presented to the airflow is 8 cm², which represents an obstruction of just 1% in a 30 cm-diameter HVAC duct. Figure 10 (b) shows the measured variation of electrical output power with flow speed. The minimum operating flow speed is 3 m/s and the output power varies from 90 μW to 3.5 mW as the flow speed increases from 3 to 8 m/s. These power levels correspond to overall efficiencies of 2% and 5%, respectively, as shown in Figure 10 (b). The efficiency values are relatively low, but this is to be expected given the small size of the device. The power levels generated are sufficient to support the operation of low-power wireless sensor electronics operated at low duty cycle. An electronics module has been developed incorporating a power conditioner and microcontroller with Bluetooth Low Energy (BLE) wireless capability. This module can be accommodated in the rear section of the MWT shroud, resulting in a compact, battery-less (and maintenance-free) wireless sensor for measurement and short-range transmission of the airflow speed and temperature.

⁹⁰ Engineering Toolbox, <http://www.engineeringtoolbox.com>.

⁹¹ Weinstein L.A., Cacan M.R., So P.M., Wright P.K., "Vortex shedding induced energy harvesting from piezoelectric materials in heating, ventilation and air conditioning flows", *Smart Materials and Structures*, vol. 21, 045003 (10 pp.), 2012.

⁹² Howey D.A., Bansal A., Holmes A.S., "Design and performance of a centimetre-scale shrouded wind turbine for energy harvesting", *Smart Mater. Struct.*, vol. 20, 085021 (12 pp.), 2011.

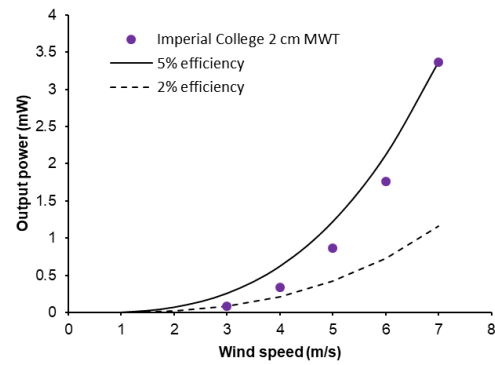

(a) (b)
Figure 10— 2 cm Diameter Micro-Wind Turbine (MWT) EH for Duct Monitoring: (a) Prototype Device with British £1 Coin for Scale; (b) Measured Variation of Electrical Output Power with Wind-Speed (Theoretical Curves for 5% and 2% Overall Efficiency)

2.3.2. Thermal-Powered Wireless Screw Connection

Author: Peter Spies

The challenge in thermoelectric power harvesting is to cope with small thermal gradients, which produce only small output voltages. There are several approaches of optimized Dc-Dc converters to convert such small voltages so that state-of-the-art electronics or storage devices can be directly supplied^[93,94,95]. A further hurdle in using TEGs for powering electronic devices is to provide a permanent thermal difference at the TEGs, often requiring a heat sink on the cold side of the TEG. The dimension and design of this heat sink influences the potential electrical output power because this heat sink controls the heat exchange of the cold side of the TEG with the environment and the thermal gradient at the TEG.

Since the thermal gradient for energy harvesting must be present on a surface, such as a housing of a machine or a pipe or duct, such spots are promising for the application of self-powered wireless sensors. The combination of a commercial thermoelectric generator module with an ultra-low voltage Dc-Dc converter and a BLE module builds a universal platform for self-powered wireless sensor system for different sensor use-cases. The amount of useable power from such a system is mainly influenced by the thermal gradient, the efficiency of the TEG and the Dc-Dc converter, and the size of the heat collector and heat sink, which may be built by the housing of the whole device. With a size of 6.5 *4 *2.5 mm³ (Figure 11) and a round shape as its bottom plate, the whole system can be mounted on the surface of a pipe, which provides a thermal difference to the ambient of at least +4 or -4 K. The output power of this system at 4 K is around 100 μ W, which is enough energy to power the BLE wireless system once every two seconds and transmit sensor data. One example is a leakage sensor to detect any leakage of the pipes, which can also be a predictor for upcoming corrosion. Alternative sensors are temperature sensors to detect overheating of machines or fluids, or vibration sensors to measure unwanted vibrations due to mechanical failure. There are already some early products on the market that combine thermoelectric generators with wireless transceiver and temperature sensors^[96].

⁹³ Pollak, M., Mateu, L., & Spies, P. (2008). Step-up Dc-Dc Converter with coupled inductors for low input voltages. Proceedings of PowerMEMS 2008 + microMEMS 2008.

⁹⁴ Pollak, M., Mateu, L., & Spies, P. (2012). Handbook of Energy Harvesting Power Supplies and Applications. Pan Stanford Publishing Pte Ltd.

⁹⁵ Dillersberger H., Deutschmann, B., Tham, D (2020). A Bipolar +/-13 mV Self-Starting and 85% Peak Efficiency Dc-Dc Converter for Thermoelectric Energy Harvesting. *Energies* 2020, 13, 5501; doi:10.3390/en1320550. www.mdpi.com/journal/energies.

⁹⁶ WirelessHART TSP300-W temperature sensor, ABB, new.abb.com/products/measurement-products/temperature/process-industry-head-thermometers/tsp300-w-wirelesshart-temperature-sensor.

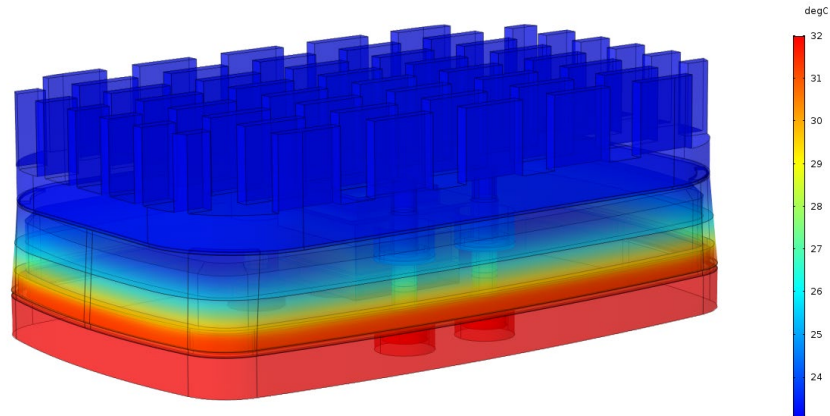

Figure 11 — Thermal Modelling of a Wireless Sensor Housing with Thermoelectric Power Supply (6.5*4*2.5 mm³)

In some application areas, especially outdoors on large buildings, the BLE connection might not be sufficient regarding coverage and robustness. Therefore, wireless standards with higher transmit power like so called Low-Power Wide Area Networks (LPWAN) can be used. An example for such a LPWAN is the mioty® protocol, which stands for My-Internet-of-Things. It has a coverage of up to 15 km at very low power consumption and is using the telegram-splitting protocol, which is a patented and standardized protocol to achieve a high transmission robustness, such as in industrial scenarios. Such wireless systems with higher transmit power require more power from the harvesting system or the duty cycle of transmission frequency has to be reduced. With a thermal gradient of 5 K, a message every 15 minutes can be realized with the mioty protocol (Figure 12)^[97].

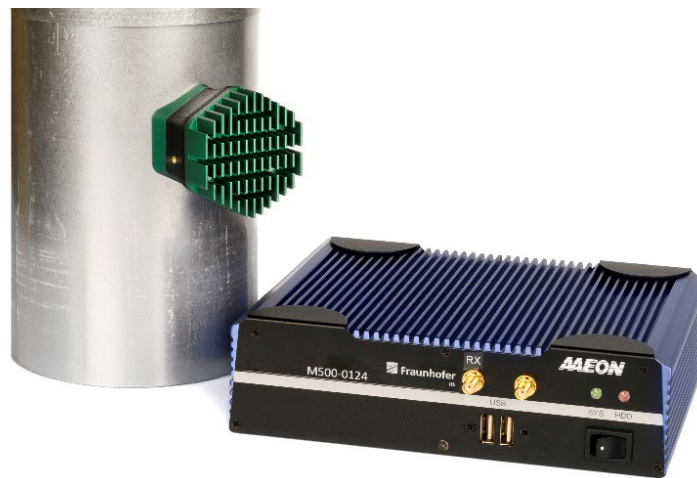

Figure 12 — Self-Powered Mioty® Module Attached to a Pipe with Nearby Base Station

For monitoring critical infrastructure, large construction, wind turbines, or large vehicles; the combination of a TEG with a dedicated Dc-Dc converter and the LPWAN module can be integrated in the housing of a screw. With a pressure and temperature sensor on the washer of the screw, connected to the head of the screw, where the TEG and the electronics are located, an intelligent screw connection is realized. The pressure sensor on the washer measures the preload force of the screw (Figure 13). In this way, a loss of preload force due to wear-out, corrosion, or any critical failure can be detected and transmitted wirelessly. This element can increase the security of any mechanical structure by enabling remote monitoring with low installation effort, which reduces maintenance cost. Maintenance-on-demand can be established, replacing only when the quality of the connection is under a given threshold. Uses might include bridges, wind turbines, couplings, and punching machines.

⁹⁷ Kemeth, F., Pollak, M., Gemeinhardt, A., & Spies, P. (2020). Maintenance-free MIOTY LPWAN enabled by Energy Harvesting. Embedded World Conference. Nürnberg.

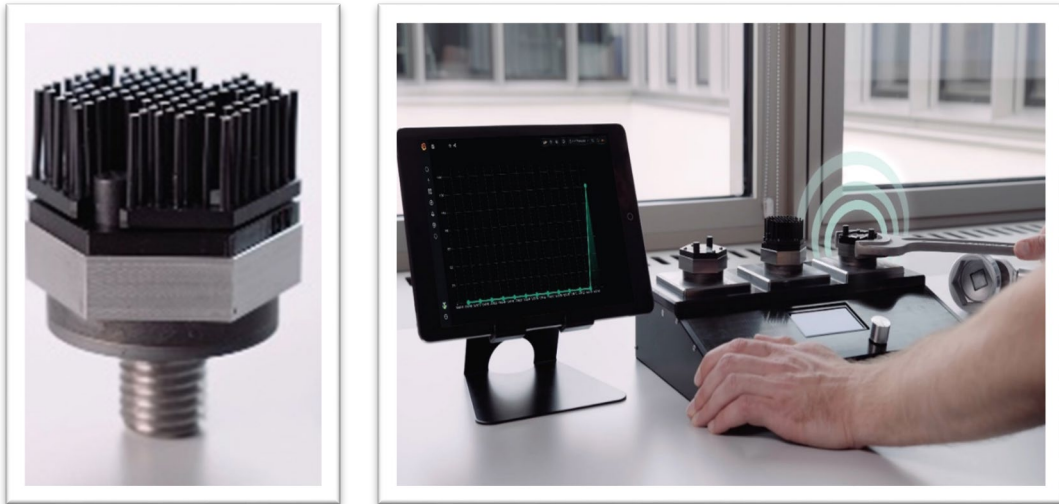

Figure 13 — Intelligent Screw with Thermoelectric Power Supply and LPWAN Connectivity (M18 screw size, left), Demonstrator with 3 Screws and Tablet PC for Visualization (right)

2.3.3. Innovative Sensorless and Battery-Free Platform to Monitor Ambient Light

Author: Roberto La Rosa

Introduction

Light monitoring in home environments, intelligent offices, airports, hospitals, etc. is increasingly assuming a fundamental role in the continuous search for a more comfortable life. In this context, the system shown in Figure 14 describes an energetically autonomous and battery-free ambient light monitoring system. The system implements a photovoltaic transducer, which simultaneously provides power and light measurement functionality with readings in the time domain. This architecture differs from conventional ones as it does not have a specific sensor unit. It consists of a battery-free, energy-autonomous sensor tag and a base station. The base station base, unlike the battery-free sensor tag, is powered by a stable form of energy and therefore has no energy supply problems. The battery-free sensor tag acts as a light intensity to time converter, i.e. more light translates into more frequent broadcasts. The base station does the reverse operation of converting time into light intensity. Therefore, the transmission frequency of the beacons contains information relating to the measurement of the light intensity.

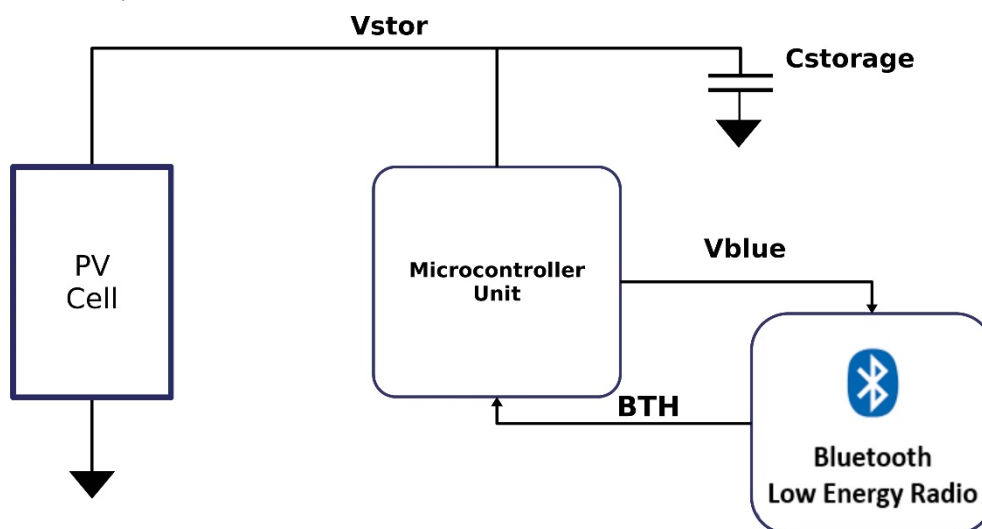

Figure 14 — System Block Diagram

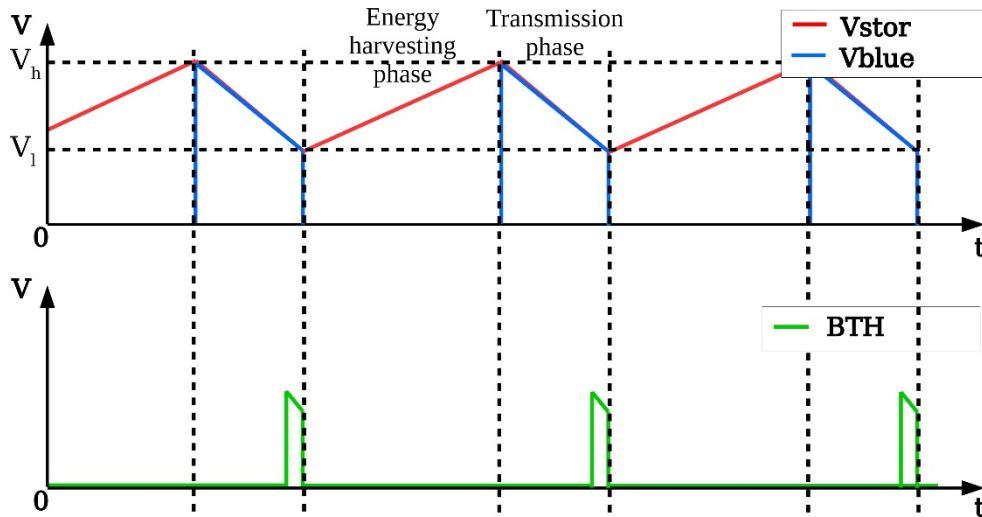

Figure 15 — Functional Description of the System

System Description

As shown in Figure 15, the system alternates an energy harvesting phase with a data transmission phase in which the energy stored supplies the Bluetooth Low Energy (BLE) radio. During the harvesting phase, the light energy is converted into electrical energy by the photovoltaic cell that provides a current that charges the capacitor C_{storage} and causes the build-up of the voltage V_{stor} . This voltage is sensed and monitored by the microcontroller unit (MCU) configured to work in ultra-low-power mode. The most critical part of this system is efficient energy management. For this reason, the appropriate choice of commercial off-the-shelf (COTS) device is critical in terms of energy consumption. Based on these premises, for the control and power management subsystem, the ultra-low-power microcontroller STM32L0, by STMicroelectronics was chosen. For the communication unit, the part of the system that consumes the most energy, the BLE module BlueNRG-M2SP, provided by STMicroelectronics, has been used. Regarding the photovoltaic transducer, in addition to the size and weight requirements, the performance of PCE at the minimum specified light intensity of 200 lux is relevant. For these reasons, the amorphous silicon solar cell am-1606C by Panasonic was chosen.

System Implementation

Figure 16 shows the top view of the printed circuit board (PCB) used to carry out the experiments and log the experimental data. A second BLE radio system, configured in receiving mode, operates as a base station and receives the beacons transmitted by the battery-free BLE sensor. Several tests have been performed in a typical home environment to monitor the beacons received by the base station and measure the elapsed time between the consecutive broadcast events. The time readout of the sensor provides an indirect estimation of the light intensity during the day. These time measurements, with appropriate time thresholds, implement convenient use cases such as closing and opening roller shutters or turning on lights, emulating the behavior of a twilight switch. These implementations show the battery-free light monitoring system in a home and building automation scenario. In these environments, it is often necessary to install numerous sensors that, to be convenient, must be energy-independent and not require maintenance. Figure 17 shows the average time elapsed between the received beacons at the base station during a whole day. It reveals that when the light intensity has a low value (below 150 lux in the time frame 6:30 am - 7:42 pm), the battery-free BLE sensor does not transmit any beacon and no data is available to be displayed. When there is abundant light, the system works more; when there is little light, the system works less and data is conveyed indirectly by the number of beacons per time unit and not by a number in the data packet.

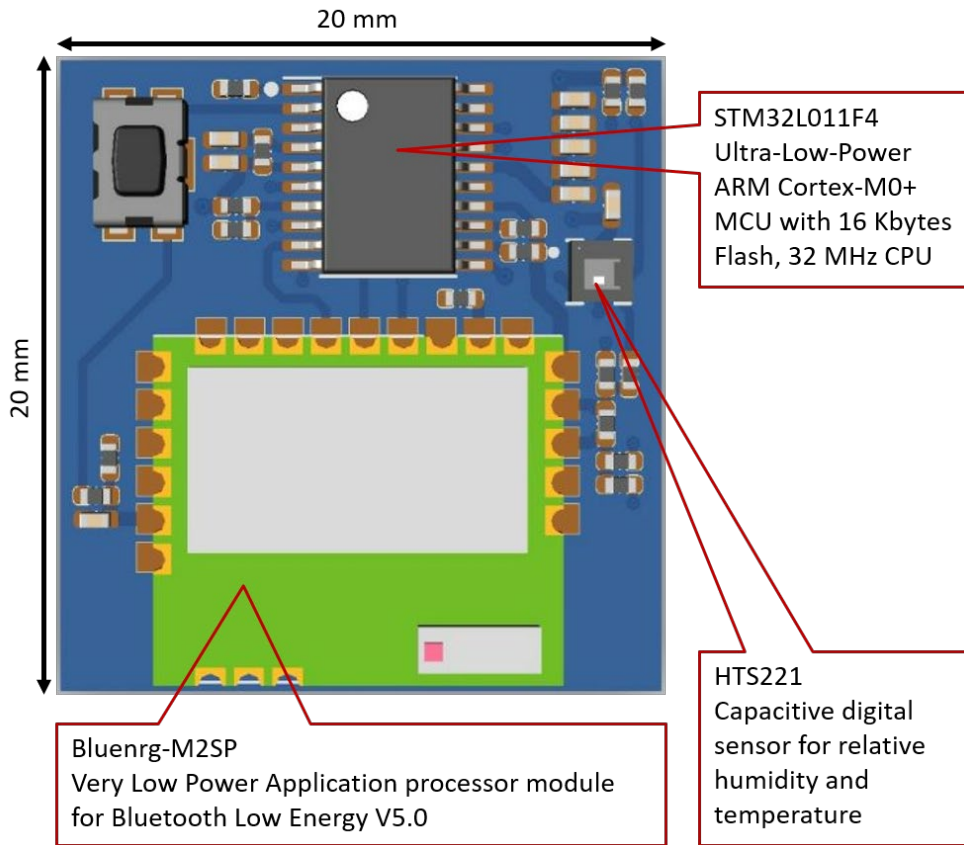

Figure 16 — PCB Top View

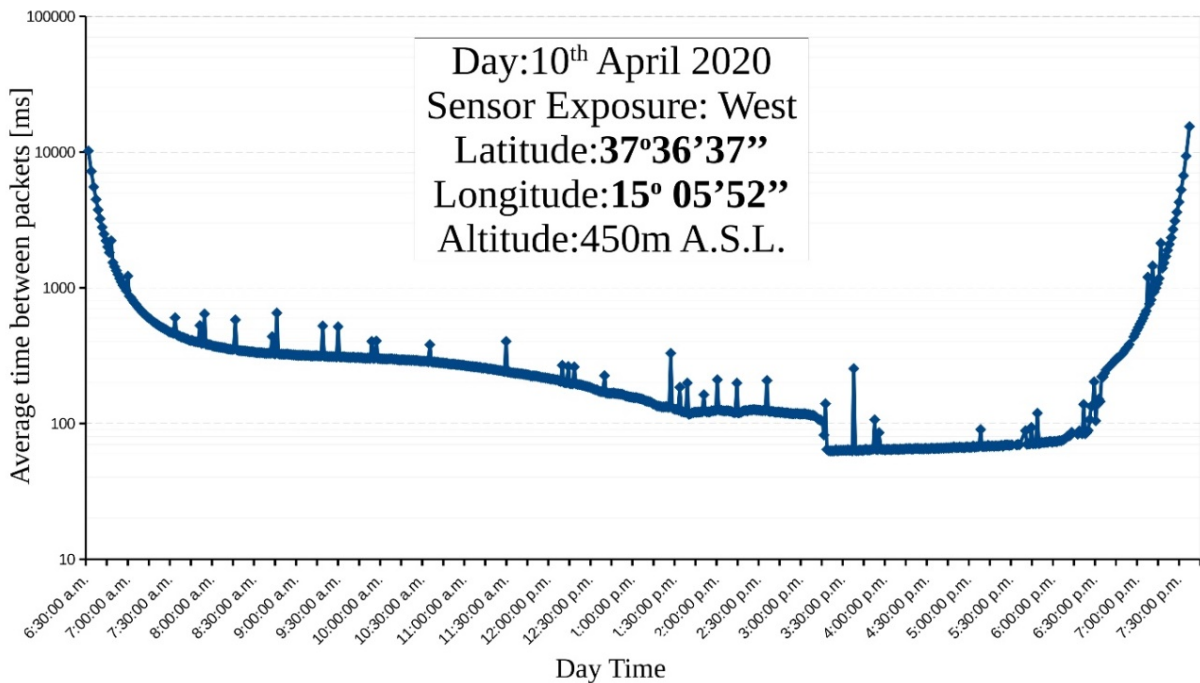

Figure 17 — Average Time between Packets (Log Scale) vs. Day Time

2.3.4. Remotely Powered Temperature Sensor for Monitoring Food Cooking

Author: Roberto La Rosa

Introduction

For optimal cooking of food in an oven, it must provide the right level of power. It is necessary to know the temperature of the food during cooking. Currently, most of the commercially available ovens use wire-connected thermometers. State-of-the-art wire-connected probes are inconvenient in this environment due to high temperatures and food hygiene practices. Wireless probes are a welcome improvement, but powering wireless probes is challenging. Since batteries typically require much lower temperatures for safe operation, energy harvesting (EH) or wireless power transfer (WPT) solutions offer an attractive alternative. This section explores the realization of a wireless and battery-free temperature probe. It is powered through RF WPT and uses Bluetooth Low Energy (BLE) communication to transmit the measured temperature.

System Description

Figure 18 illustrates the system that uses RF WPT to remotely power a battery-free temperature probe equipped with BLE communication. The figure puts in evidence the two units: (i) the block diagram of the RF Reader, (ii) the block diagram of the self-powered, battery-free BLE temperature probe. The system performs RF WPT at 2.4 GHz. EU regulations allow a maximum transmitted power of +27 dBm, in the frequency band of 2.446 - 2.454 GHz with no restrictions. The reader is implemented with the integrated circuit (IC) BLUENRG-2 provided by STMicroelectronics. It works both as a power transmitter and a data receiver. As a power transmitter, the BLE radio can deliver up to 8 dBm of power at 2.4 GHz. As a data receiver, it performs a sensitivity of -88 dBm. The self-powered, battery-free temperature probe is implemented with two ICs: (i) a System on Chip (SoC), implementing an RF power receiver, and (ii) A BLE radio, the BLUENRG-2 IC in advertising mode.

Figure 18 shows the block diagram of the SoC. The integrated circuit includes an RF-to-Dc converter, ultra-low-power management, a low-drop-output Dc-Dc converter, and a digital Finite State Machine (FSM). The RF-to-Dc converter has a low power sensitivity of -15 dBm at 2.4 GHz and maximum power conversion efficiency (PCE) of 16 %. This circuit converts the RF power signal from the reader into Dc power and stores it in the storage capacitor $C_{storage}$.

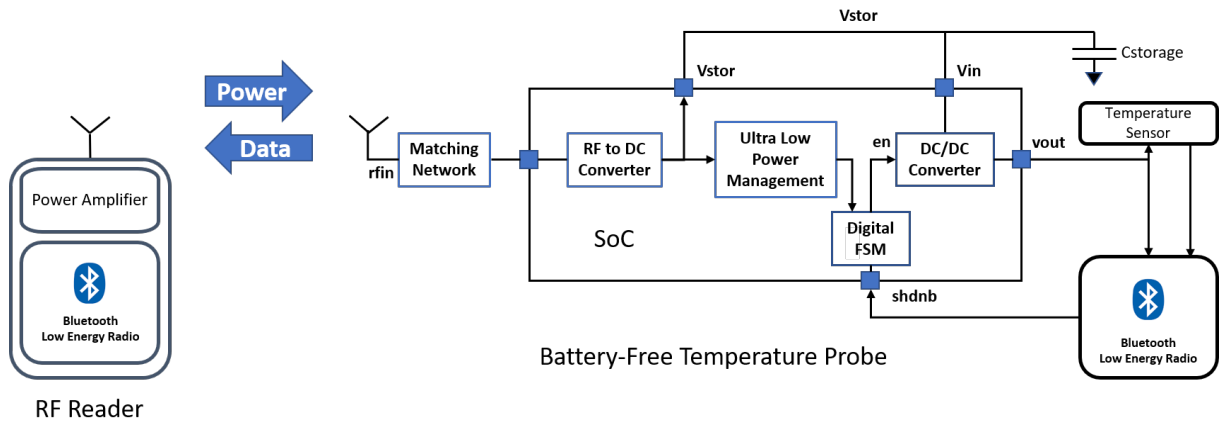

Figure 18 — Block Diagram of the RF-Powered Battery-Free Temperature Probe

System Design

The energy required by the battery-free temperature probe is given, in the first approximation, from the sum of the energy needed by the BLE radio to perform data transmission in non-connectable advertising mode and the energy required by the system to perform the temperature sensing. Inside the oven, 70 cm is the maximum specified distance d_{max} between the RF reader and the battery-free temperature probe. This distance corresponds to attenuation in free space of -37 dBm at 2.4 GHz. Based on these assumptions, it is possible to choose the lowest transmission power, -14 dBm, for the transmitting BLE radio of the probe. This choice leaves a margin of -37 dBm to the sensitivity of the BLE radio in scan mode. The BLE IC of the temperature probe has an energy consumption of about 30 μ J to be added to the maximum energy consumption of the temperature sensor system of about 15 μ J. Therefore, the total energy required by the battery-free BLE temperature probe is 45 μ J per

sense operation. For the maximum effective isotropic radiated power (EIRP) of 27 dBm, the BLE IC, connected to the 2.4 GHz power amplifier SE2433T IC, is configured to deliver an output power of 8 dBm, which introduces a power gain of 20 dB. For interference minimization with other advertising channels, the BLE radio is configured to transmit on the single channel, number 23, corresponding to the frequency of 2.45 GHz. By transmitting the maximum power P_t of 27 dBm, with the gain of the receiving antenna of G_a 3 dB, at the maximum distance d_{max} between the reader and the battery-free temperature sensor of 70 cm; the input power at the antenna P_r , as given by the following equation, is equal to -7 dBm, which is $\approx 450 \mu W$:

$$P_r = P_t|_{dbm} - 40 dB + G_a|_{dB} + 20 \cdot \log_{10} \frac{1}{d_{max}}$$

For this value of input power, the PCE of the RF-to-Dc converter is at the maximum value of 16% and received power at the storage capacitor is given by:

$$P_{Cstorage} = PCE \cdot P_r = 72 \mu W$$

Figure 19 shows the realization of the system. The portion of the temperature probe inserted into the food is a steel needle with an outer diameter of 5 mm, an inner diameter of 4 mm, and 4 cm long. The board containing the electronic circuits fits inside the needle. While cooking food, the steel needle in the food and cannot reach temperatures above 100°C. The antenna stays out of the food and is a metal track inserted in a ceramic capsule capable of withstanding temperatures of 300°C. Figure 20 shows the trend of the main system signals: V_{stor} , shdnb, V_{OUT} and, en. Among these signals, shdnb is particularly significant as it grants the successful transmission of the beacon to the base station.

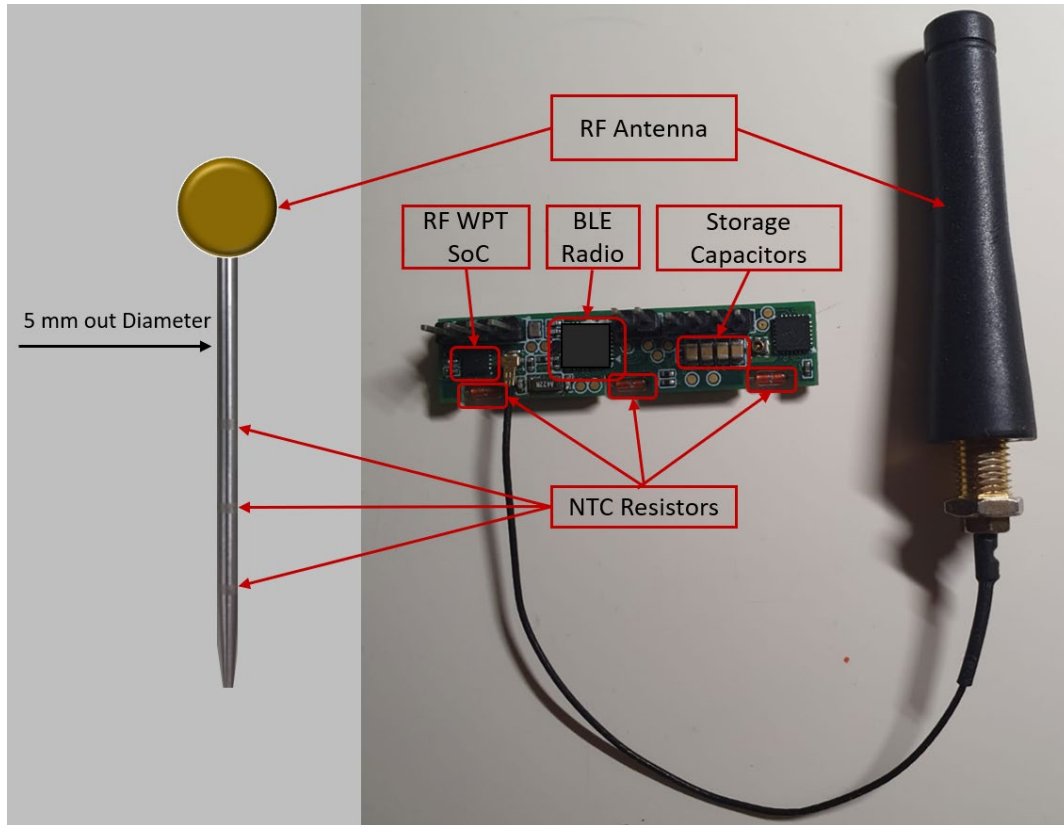

Figure 19 — System Implementation

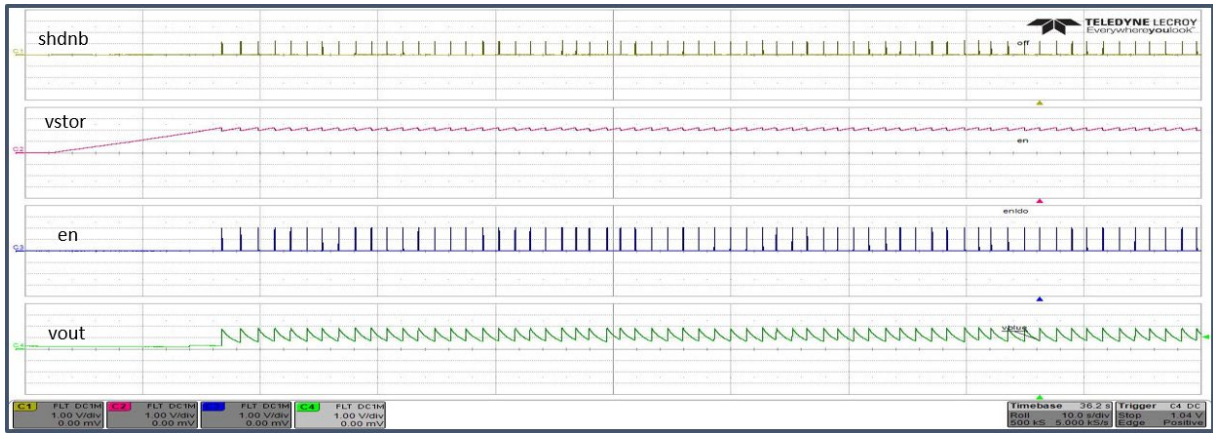

Figure 20 — System Signals

3. Key Elements for Industrial Adoption

Editor: Thomas Becker

3.1. The Industrial Challenge

Author: Thomas Becker

Energy harvesting offers many advantages over batteries or wires as described in the previous chapters, but technology user perspectives may differ dramatically from an individual technology provider, since the total system performance requirements are essential. Commercial user expectations are clearly focused on the overall efficiency enhancement instead of technology improvements. For successful implementation in future applications, several acceptance limitations must be solved. Key challenges are listed below:

- System integrators are accustomed to specifying the technical behavior of a device as a black box with defined interfaces for input and output parameters. In the case of energy harvesting devices, detailed information about the installation environment is required by the supplier. Even though system integrators and Tier-X suppliers are working today in closed-loop development frames, the exchange of data is critical. For example, the data of vibration frequencies and amplitudes of a car or an aircraft may exhibit design compromises in terms of noise or comfort.
- Durable assets; such as cars, machinery, or aircraft; require a certain meantime between failures (MTBF) guarantee. The consequences for the subsystem where the energy harvesting device might be integrated, must be considered in case the expected lifetime cannot be achieved. As a consequence, the user's confidence in the product can fade.
- In most cases, energy storage is required in addition to the energy harvester device itself. In general, batteries or supercapacitors are often seen as a potential hazard because of the high energy density. In any case, due to the electro-chemical nature of storage devices, limitations in lifetime and maintenance costs are expected.
- Adequate energy supply in non-standard operation; such as during maintenance, repair, and overhaul (MRO); is a key challenge for energy harvesting. The energy harvesting devices are designed to cope with a broad spectrum of in-service operations. However, during MRO, longer downtime, or other unexpected events; the energy harvester might not supply energy and the energy storage source drained. Changing procedures for MRO or restarting the system is costly and unlikely to be implemented.
- Materials aspects and recycling are likely to generate additional costs. Energy harvesting devices may contain substances that are difficult to recycle while complying with RoHS and REEACH obligations.
- Obsolescence management is another key challenge. In the emerging dynamic market of energy harvesting devices, the provision of spare parts is a critical issue. Lack of standards and the dominance of start-ups in the market make long-term supply chain sustainability unclear.

These aspects need be carefully analyzed in a detailed cost-benefit-analysis (CBA). Moreover, the CBA needs to be substantially supported by a cradle-to-grave life cycle assessment (LCA). In addition, standardization efforts should be made to pave the way for using energy harvesting devices.

3.2. Component Level

Author: Baoxing Chen

For broad adoption of energy harvesting for IoT, performance, cost, packaging, and ease of use are a few of the key issues that need to be addressed at the component level.

While IoT system efficiency continues to improve due to advances in ultra-low power technologies such as low-power processors, low-power radio, low-power sensors, and low-power management; the demand for computing power also increases with more functionality and more intelligence at the edge

node. For energy harvesters to power the IoT, the amount of energy that can be harvested needs to be enough to provide for the load. However, many commercially available harvesters suffer from low efficiency. Low efficiency is not only limited by the harvester performance, but also by practical application environmental conditions. For example, a typical IoT system has limited temperature gradient, which limits the power efficiency for thermoelectric harvesters. Low light density indoors, where the IoT systems are typically installed, limits the power efficiency for PV harvesters. Broad vibrational spectrum, together with low frequency, limits the energy efficiency for narrow-band piezoelectric harvesters or electromagnetic harvesters. It is important that the performance of various harvesters continues to improve despite these practical constraints. For the thermoelectric harvesters, thermoelectric material advances for higher figure of merit, as well as structural improvements to maximize the temperature gradient across the thermoelectric junctions, will help to improve system efficiency. High-efficiency PV panels such as multi-junctions or new techniques for light to electricity conversion will help to improve the system efficiency for PV harvesters. Various wide-band harvesters or circuit techniques will help improve the energy efficiency for the vibrational harvesters.

Despite compelling benefits of energy harvesters over batteries, the extra cost from the harvester needs to be justified by system savings. Energy harvester costs must improve substantively for broad IoT adoption. For example, thermal harvesters require many thermoelectric junctions connected in series to provide meaningful and operational output voltages for the power management circuits. Semiconductor integrated circuit processing can be leveraged to make thermoelectric harvesters with hundreds of thermoelectric junctions in a small chip area to reduce the cost significantly compared with that of the discrete harvesters. While piezoelectric and electromagnetic harvesters have limitations in scaling down from macro scale harvesters, MEMS structures remain promising in reducing the harvester cost. However, significant advances are still needed to produce solutions that are competitive with discrete component harvesters; for example, techniques to fabricate much thicker beams, larger masses, and larger movements are needed.

For broad adoption of energy harvesters, easy to mount and cost-effective packages are required. The amount of energy that can be harvested depends heavily on package design. For example, packages for the thermoelectric harvesters need to be designed to mount for maximum temperature gradient can be obtained across thermoelectric junctions. In many cases, a heat sink may be required. The package for the harvester needs to facilitate the mechanical interface between the heat source and the heat sink. Vibration harvesters, on the other hand, need to be designed to safeguard mechanical robustness while obtaining maximum movement of mechanical structures for maximum power.

The compelling value for energy harvesters is to enable maintenance-free operation. System integration and ease of use is especially important. There is significant value to integrate more functions at the component level to facilitate system integration. For example, energy harvesters can be integrated with power management devices as well as storage devices so the component can appear as a self-charging battery. This way, system integrators can redesign their battery-powered system into an energy harvester powered system by swapping out the battery and substituting this package integrated component. Component-level package integration is not only cost-effective, but also has potential to reduce design cycles for system integrators. Further processor and software enabled energy harvester components can be a game changer for broad IoT adoption.

3.3. Industrial Perspectives

3.3.1. Electronics Industry

Author: Patrick Riehl

For broad adoption of IoT, an order-of-magnitude estimate for the energy required to perform various functions must be defined. A partial catalog of energy consumption for various functions of IoT sensor nodes is given in Figure 21. Energy per bit is used as the metric to compare functions in a signal chain that may have different data rates and duty cycles.

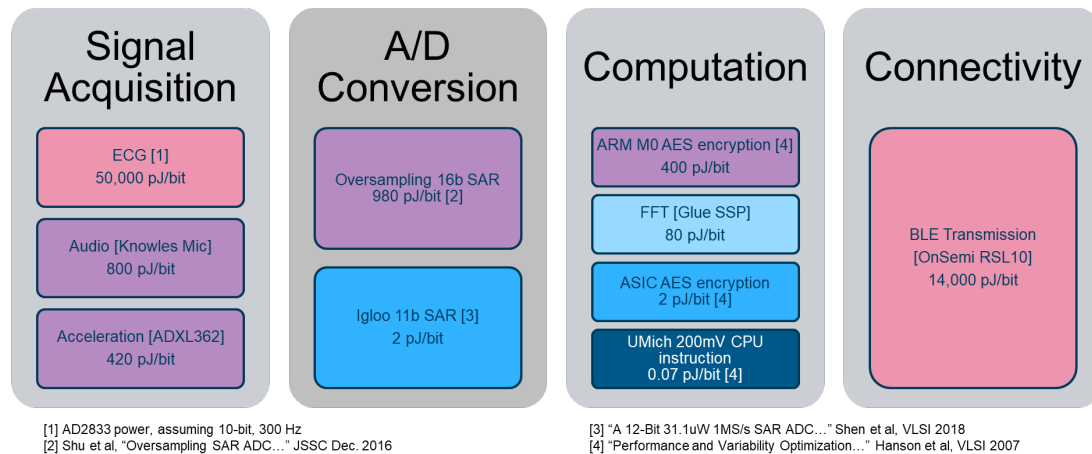

Figure 21 — Estimated Energy Consumed by Various IoT Sensor Functions (Blue = Low Energy; Red = High Energy)

A wireless sensor node interacts with physical media at two interfaces: the sensor (signal acquisition) and the RF interface (connectivity). In a simple sensor node, these two functions typically dominate the power consumption because a certain amount of energy must be spent to overcome physical limits. Sensors that must produce a stimulus, such as an optical photoplethysmogram (PPG) sensor, tend to be on the higher end, as well as those that must resolve very weak signals, such as clinical-grade electrocardiograms. At the connectivity interface, even the most energy-efficient protocols, such as Bluetooth Low Energy, can dominate the power budget for many sensors.

The interior of the sensor typically includes A/D conversion and computation. For medium-to-low resolution applications (<12 bits), digitizing the signal costs negligible energy compared to other functions. Generally, power scales as $2^{(\text{number of bits})}$. High-resolution applications may require significant energy to be allocated to the ADC, but these applications also typically require significant power for signal acquisition.

The computation segment shows the widest range of variation of energy metrics. At the cutting edge of academic research, sub-threshold processors can complete simple instructions for fractions of a pJ/bit. General-purpose processors doing more intensive computations can dominate the power budget of a sensor node. Given the trend towards more intelligent sensors and more processing at the edge, expect the demand for computation to increase.

It is useful to classify sensor nodes according to the stage of the signal chain that dominates the power consumption. Using this classification helps determine what technologies might save power in a given application, as illustrated in Table 9 .

Table 9 Sensor Nodes Classified by the Dominant Power Consumers

Class	Sensor-limited	Computation-limited	Connectivity-limited	Overhead-limited
Power Dominated by	Signal acquisition	Computation / DSP	Data transmission	Standby and leakage currents, maintenance activity
Precision (typ.)	High	Any	Low	Any
Data Rate	Low	High	High	Very Low
Examples	<ul style="list-style-type: none"> ▪ PPG ▪ Clinical ECG ▪ SpO2 ▪ Gas sensor 	<ul style="list-style-type: none"> ▪ HR detection with motion ▪ 3D navigation ▪ Voice recognition 	<ul style="list-style-type: none"> ▪ Machine health monitor ▪ Wellness ECG ▪ Voice feed 	<ul style="list-style-type: none"> ▪ Environmental monitor ▪ Event detection
Power-Reduction Techniques	<ul style="list-style-type: none"> ▪ Analog techniques ▪ Adaptive sampling (including AFE) 	<ul style="list-style-type: none"> ▪ Near-threshold computing ▪ Adaptive voltage scaling ▪ Analog computing ▪ In-memory computing 	<ul style="list-style-type: none"> ▪ Data compression ▪ Data analytics ▪ RF techniques 	<ul style="list-style-type: none"> ▪ Duty cycling ▪ Passive wakeup

With connectivity-limited sensor nodes, those with low precision but high data rates, the main objective is to reduce the volume of data transmitted to the network. This goal can be accomplished by applying intelligence at the edge node, as demonstrated by the example of a voice monitor. Without digital signal processing at the edge node, there would be no option but to upload a continuous uncompressed audio stream. Applying audio compression greatly reduces the payload size. If the voice monitor can recognize an activation phrase and only transmit data when the phrase is spoken, transmitted data and transmission energy can be drastically reduced. In the case that a complete data stream is required to be transmitted to the host, specialized digital compression techniques may be the best way to reduce the outgoing bit rate.

Sensor-node systems in the computation-limited class require substantial digital processing to extract information at a high level of abstraction. Differentiation in this segment could come down to who has the most efficient algorithm or the most energy-efficient processor.

For the sensor-limited class, with the highest precision but low data rates, the focus has been on utilizing analog techniques or adaptive and compressive sampling to reduce the power consumption of signal acquisition. Healthcare applications often fall into this category.

Sensors that operate at very low data rates may end up dominated by the power of inactive circuits, sometimes called standby or quiescent power. An obvious solution is to shut down these circuits when not in use and finding ways to autonomously detect and activate based on the context and application needs. IoT nodes with very low data rates can also end up dominated by the quiescent power of the power management circuits—an overhead-limited case that can be addressed with ultra-low power Power Management Units (PMUs).

3.3.2. Energy Harvesting in Aviation — Aircraft Manufacturer Perspective

Author: Jan Mueller

Background: Aircraft weight and maintenance are two key drivers for commercial aircraft design. Therefore, reduction of the number of wirings is always a valuable goal. As a result, the use of wireless for data connectivity is considered carefully for many future applications.

On the other hand, digitalization and IoT is just arriving in aviation. Reducing unscheduled maintenance is of high interest as it remains very expensive for airline customers and has been since the very beginning of commercial aviation. Therefore, it would be very helpful to predict when and what component will fail. These would be beneficial for new aircraft and even more for aircraft in service already. For these types of functions, data is needed. One source of that data is additional and autonomous sensors, perhaps installed in overnight stops. Full autonomous sensor nodes require an electrical power supply, such as batteries or thermoelectric / solar / vibration harvesting.

In the past, Airbus conducted several R&T activities to evaluate the capabilities of a number of energy harvesting methods. This includes flight tests for several systems. The most recent test campaign was stopped because to the COVID crisis. So far, none of the activity has reached the entry to a real service yet. Nevertheless, energy harvesting is continuously being considered as a primary candidate in the field of IoT for data collection applications within the next few years.

Environment and Operation: Most of the energy harvesting principle relies on usage of ambient energy, which is very limited by its nature, changing over time and not always present. Therefore, a power storage buffer must be considered in all cases to ensure the continuous operation of such devices. The sensor or equipment operation has to be designed according to the application behavior and where it will be installed. In general, this means very low data rates, low-measurement duty cycles, and sometimes even complete loss of operation. The latter is very hard to overcome. One example is an aircraft in a prolonged storage (such as grounded due to COVID). There may be insufficient energy to cover the entire deactivation period. The very low data rate limits the application range or introduces means for intelligent data handling (e.g. compression or event-based operation).

Table 10 Comparison of Harvesting Methods Evaluated

<i>Method</i>	<i>Pros</i>	<i>Cons</i>
<i>Thermoelectric harvesting → static with constant temperature difference</i>	<i>Very good on places with constant temperature differences</i>	<i>High mechanical effort for heat pipes; TEGs are sensitive to vibration; may require high effort for repair</i>
<i>Thermoelectric harvesting → dynamic harvesting using the temperature difference between inflight and ground temperature</i>	<i>Suitable outside fuselage in cold areas Good candidate for structural monitoring</i>	<i>Scarce energy for certain flight profiles with no temperature changes (e.g. cold regions) TEGs are sensitive to vibration High effort in design (e.g. head pipes)</i>
<i>Power line harvesting using a inductive coupling on existing power line</i>	<i>Suitable where power cables are already installed Continuous energy supply</i>	<i>Cable to next power line is still needed</i>
<i>Photovoltaic harvesting</i>	<i>Simple design</i>	<i>Larger surface needed</i>
<i>Vibration harvesting</i>	<i>Suitable for places near engines</i>	<i>Larger weight Vibration frequency dependent</i>

Identified Risks: Within the performed activities around wireless sensor applications, a number of issues have been identified as preventing EH from being in service today. One of major points to consider is the question of available components and comparable applications outside aviation. This is limited to a number of niche applications far away from the mass market. In fact, these are additional blocking points for acceptance of new technology. Further on, there are no ruggedized components available that meet typical environmental constraints for aviation, such as temperature range, vibration, and aging. Most of the suppliers cannot give values for environmental behavior over longer time horizons. It would be much helpful if such ruggedized solutions were available that focus won a complete solution (harvester, storage, and energy management). Even better would be a product family of solutions for different EH or size of energy storage.

On the other hand, EH is in competition with batteries that have improved significantly over the years. A battery is a universal solution, which means it does not depend on the installation place and the available energy there. Each place for an EH installation has to consider its own analysis, design, development, and test. This is a clear cost driver. The current most important trait is the maintenance effort for batteries compared to the effort and uncertainties and risks for EH. However, batteries with high energy densities exhibit a certain risk of thermal instability and this needs to be treated with dedicated countermeasures.

For buffering energy, there are two principles to consider: the usage of capacitors / supercapacitors and small batteries. The trade-offs associated with these are outlined in Table 11 .

Table 11 Trade-offs between Battery and Supercapacitor Storage Solutions

<i>Method</i>	<i>Pros</i>	<i>Cons</i>
<i>Capacitors</i>	<i>Well known, mature</i>	<i>Large volume and weight</i>
<i>Supercapacitors</i>	<i>Very small, low weight</i>	<i>No guaranteed long term behavior (ageing, loss of capacity) Sensitive to vibration</i>
<i>Batteries</i>	<i>Well know, low weight</i>	<i>Risk of thermal runaway (large weight with protection) Regular maintenance is required</i>

Outlook: The field of IoT for aviation offers many near-term possibilities for EH solutions. Many of these applications are not safety critical and therefore preferred candidates for a first entry into service. Nevertheless, batteries are in services already and upcoming power transfer technologies are under investigation as well.

Summary: The principle of energy harvesting has been studied for a number of years. There is no application that has reached a maturity level to become part of a commercial aircraft system yet. The main reason is the availability of components for aviation as a niche market with high requirements for environmental qualification. Nevertheless, energy harvesting is continuously being considered as a primary candidate in the field of IoT for data collection applications within the next few years.

3.3.3. Buildings and Physical Access Control

Author: Dominik Samson

Automated doors with access control systems or lockers are perfect examples where energy harvesting would be a nice improvement. However, there are no off-the-shelf solutions available that offer battery-like retrofit simplicity so the industry sticks with batteries.

Table 12 provides an overview of why the individual energy harvesting options from Section 1 do not qualify in general for building applications in physical access control (PAC), for example.

Table 12 Assessment of Energy Harvesting Technologies in Building Applications*

<i>Energy Harvesting Method</i>	<i>Reason for Disqualification in PAC</i>
Motion	<i>Buildings do not move or have huge vibrations</i>
Thermal	<i>Buildings minimize heat flux and operate in a small temperature range</i>
Inductive	<i>Requires a powerline harvesting source</i>
RF	<i>There are no RF fields in buildings except some NFC sources, e.g. from mobile phones^[1]</i>
Solar	<i>Little light inside buildings and PV cells interfere with design</i>
Acoustic	<i>Buildings are typically quiet</i>

*Typical PAC readers consume around 0.5 W minimum^[2]. Very low power versions for with batteries go down to 0.13 mW^[3,4].

There might be situations where selected energy harvesting methods work, but it is always a case-by-case decision. Considering that effort, batteries or cables are still more economic.

Case Example: How to wire a building after initial construction.

Situation: A PAC system for buildings manages automated door opening to authorized personnel. Such systems need badge readers at the doors, as shown in Figure 22(a). Actuators and controlling units result in a lot of cabling. Figure 22(b) shows a typical PAC controlling unit installation and gives an idea of the amount of cabling needed.

The cabling effort is already high when the PAC system is planned with the building^[5]. However, there are many cases when a PAC system is installed after, e.g. when a new tenant moves into a building. In such cases, even more cables need to be installed.

¹ "Energy Harvesting in Aircraft with Special Focus on Thermoelectrics", Samson, D., ISBN 9783843904537, <https://books.google.de/books?id=w2JGMwEACAAJ>, 2012, p. 23ff, Dr. Hut.

² "HID® Signo™ Readers Models: 20, 40, 20K, 40K datasheet", https://www.hidglobal.com/sites/default/files/resource_files/pacs-signo-reader-family-ds-en.pdf, HIDglobal.com.

³ "iLOQ S5 Your smartphone as a key and power source", <https://www.ilog.com/en/technology/mobile-access-sharing-solution-ilog-s50/>, ilog.com, © 2017 - 2020 iLOQ Ltd, accessed November 12, 2020.

⁴ "CX6211 Technische Daten", https://uundz.com/fileadmin/uundz_downloads_de/Datenblaetter/SO_UZ_CX6122_PRUE2020_007FE7.pdf, uundz.com, UHLMANN & ZACHER © 2020.

⁵ "Access Control", <https://uit.stanford.edu/service/idcardservices/servicedescription>, Stanford University IT.



Figure 22 — (a) Employee Opens Office Door with Badge^[6]; (b) Access Control Installation in a Public Building in NYC^[7] showing cables required

Complication: Instead of using wires for data transfer, there are concepts that rely on wireless data communication of the PAC components in the building^[8,9,10]. There are still devices that need energy, either by cable, which requires additional wiring work, or by battery, which inflicts continuous maintenance costs for battery replacement.

Resolution: Energy harvesting offers a solution to create PAC systems that are truly cable and maintenance independent.

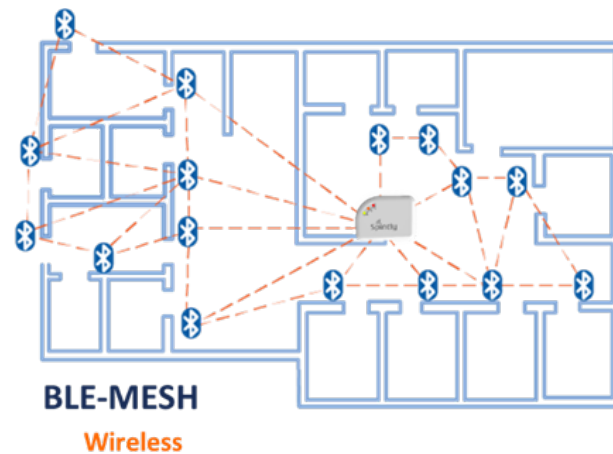

Figure 23 — Schematics of a Door Plan with Wireless Physical Access Readers at the Door^[11]

⁶ Picture courtesy of ELATEC GmbH, Zeppelinstr. 1, 82178 Puchheim, Germany.

⁷ https://www.linkedin.com/posts/isaac-roth-989a991a5_security-lobby-intercom-activity-6732378207636598784-oLUY/, picture by Isaac Roth, 11/2020, Blackstone Security INC.

⁸ "BLUETOOTH MESH FOR ACCESS CONTROL", <https://spintly.com/whitepapers/ble-mesh-for-access-control/>, Rohin Parkar, , accessed October 28, 2020.

⁹ "SALTO NEO CYLINDER", manual, <https://saltoneo.saltosystems.com/pdf/en/NEO-SAL-05-20.pdf>, Copyright © 2020 SALTO Systems SKS-ENG-RET-03-20.

¹⁰ "CX2122" manual, https://uundz.com/fileadmin/uundz_downloads_de/Datenblaetter/SO_UZ_CX2122_PRUE2020_007FD5.pdf, UHLMANN & ZACHER © 2020.

¹¹ "BLUETOOTH MESH FOR ACCESS CONTROL", <https://spintly.com/whitepapers/ble-mesh-for-access-control/>, Rohin Parkar, [Spintly.com](https://spintly.com/).

Although the readers do not need wiring for data communication, they still need cabling for power or maintenance of the batteries — neither options leverages the full advantage of the wireless data communication. Energy harvesting could provide a fully wireless and maintenance free solution.

3.3.4. Space Industry, Launcher Perspective

Author: Johannes Sebald

The drive to reduce cost for space transportation has led to the investigation of energy harvesting technology for possible launcher application by Ariane Group^[12]. Typically, four types of energy are used for energy harvesting: mechanical, electromagnetic (radio frequency), electromagnetic (light), and thermal energy. For launcher applications, thermal energy seems to be most promising due to the large temperature gradients occurring during a launcher mission and the long-term experience with the related Thermoelectric Generators (TEG) for space application in the frame of so called “nuclear batteries”. The thermal energy of decaying instable isotopes (typically Plutonium) is used to provide electrical energy via TEGs for planetary missions that allow close to no other solution for electrical energy for long mission durations far from the sun.

In principle, two application areas for TEGs are of potential interest:

- Provision of local power for autonomous (wireless) sensors with low power TEGs (1 mW - 10 mW) with the following advantages:
 - save harness mass
 - ease of integration
 - enable kit solution
- Partial substitution of batteries for launcher power supplies with high power TEGs (10 W – 100 W) with the following advantages:
 - save mass by replacing batteries
 - ease of integration and test
 - relaxation of battery condition related issues

While high power is beyond the scope of this paper (mainly focused on ultra-low power IoT devices) it is worthwhile to briefly outline a broader energy harvesting opportunity in this application sector.

For low-power TEGs, a heat source must be found (normally dissipated electrical energy from electrical equipment) and the heat flow realized by heat conduction from the equipment to the TEG on the hot side and by heat radiation from the cold side into the inside of the launcher. First use cases with commercially available TEGs have been established and simulated with good results.

For high-power TEGs, high thermal fluxes are required. Therefore, the engine was selected as the heat source. As the interference of the harvesting system with the engine should be negligible, a radiation coupling from engine to the TEG hot side was chosen as part of the nozzle is radiation cooled. Temperatures to be expected on the TEG hot side are between 700°C and 1200°C; for which no commercial TEGs are currently available. Figure 24 shows two possible designs using either the so called “heat shield” (A) or a dedicated ring (B) to install the TEGs.

¹² “Perspectives for Exploitation of Thermoelectric Generators on Future European Launchers”, Johannes Sebald, Wolff-Dieter Ebeling, Ralf Knoche, 12th European Conference on Thermoelectrics (2014), Materials Today: Proceedings 2 (2015) 833 – 848.

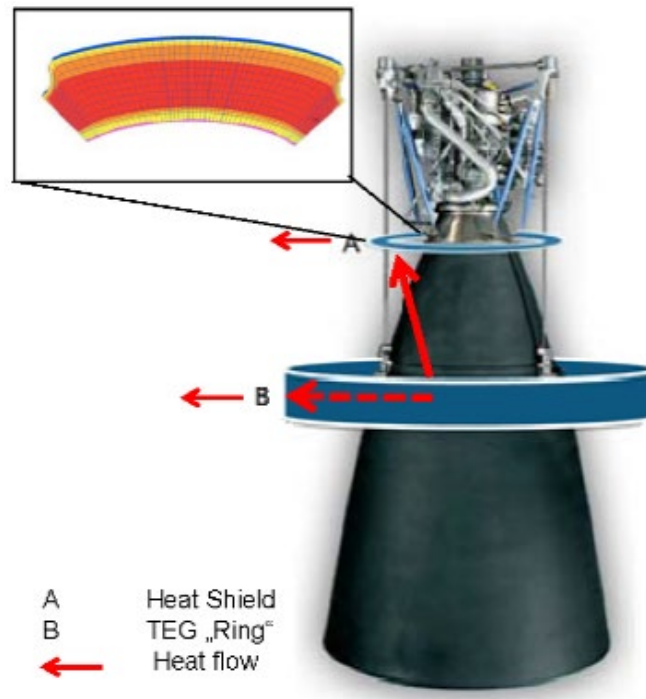

Figure 24 — Engine with Integrated TEG

3.3.5. Spatial Localization Perspective

Authors: Leonardo Govoni, Manuel Saez

The localization of an asset is performed all over the world and with high accuracy by means of multiple Global Navigation Satellite Systems (GNSS) and allows the development of multiple services related to the provision of autonomous geo-spatial positioning, such as determining the location, supporting navigation, tracking, creating maps of the world, and bringing precise timing to the world. Though GPS has maintained large-scale coverage and excellent physical positioning technology that uses a lateration technique^[13], it is not effective indoors or in underground settings^[14].

To cover this lacuna, many technologies have been adopted and tested with various results. WLAN, Bluetooth, cellular, RFID, infrared, camera, inertial, and mechanical^[15] techniques have been applied to various technologies to explore the advantages and disadvantages of each. The main disadvantages found include a coarse localization, sensitivity to interference and signal propagation effects, limited range, need of battery replacement, only working with line of sight, sensitivity to reflections, high processing requirements, and dependency on illumination conditions and environmental noise.

An emerging technology, ultra-wide band (UWB) is becoming popular in localization applications as its large bandwidth provides the ability to measure the time of arrival with high resolution and the signal is capable of penetrating through obstacles as well as being immune to reflections^[16]. This enables UWB positioning systems to reach accuracy down to a few centimeters^[17]. However, the price for this higher accuracy is higher power consumption with respect, for example, to Bluetooth.

¹³ J. Hightower and G. Borriello, "Location Systems for Ubiquitous Computing", *Location Aware Computing*, 0018-9162, IEEE, pp. 57-65, August 2001.

¹⁴ Tao Hu, G. Lachapelle, and R. Klukas. Controlled GPS signal simulation for indoors. *Journal of Navigation*, v 60, n 2, May 2007, 265-80, 2007.

¹⁵ J. Torres-Solis, T. Falk, T. Chau, "A Review of Indoor Localization Technologies: towards Navigational Assistance for Topographical Disorientation", DOI 10.5772/8678, *Ambient Intelligence*, 2010/03/01.

¹⁶ Z. Sahinoglu, S. Gezici, and I. Guvenc. Ultra-wideband Positioning Systems. 2008, p. 283. ISBN: 9780521873093. doi: 10.1017/CBO9780511541056.

¹⁷ Djaja-Josko and J. Kolakowski. "A new method for wireless synchronization and TDOA error reduction in UWB positioning system Vitomir." 2016 International Conference on Indoor Positioning and Indoor Navigation, IPIN 2016 2013 (2016), pp. 4-7. doi: 10.1109/IPIN.2016.7743635.

In the framework of the EU ECSEL JU Project EnSO (Energy for Smart Objects), the use of UWB localization for a car key fob and a person wearing a tag in an office environment was investigated. The research project is aimed at the design and development of an Autonomous Micro Energy Source (AMES), which is based on a thin battery and several energy harvesters used to power various IoT devices. Using the AMES and selected energy harvesters, an indoor localization system with navigation support was built and tested. It was based on two main location techniques: Time Difference of Arrival (TDOA) and Time of Flight (TOF)^[18]. The system was able to reach an accuracy of ca. 30 cm for the position estimation with an average current consumption of ca. 11 μ A, with peaks of 80 mA to 120 mA during 1.1 ms.

The localization system is based on five anchors connected and powered through a server that computes the position of a tag moving in the covered area, which is powered by the AMES and transmitting a beacon at 0.2 Hz, 1 Hz, or 2 Hz. The localized tag had some constraints due to the form factor (the dimensions of a car key fob) and the available battery no bigger than 25 mAh. Taking into consideration these requirements, only some of the available energy harvesters were suitable.

A motion-based energy harvester^[19] developed can generate up to 10 mW. The combination of magnetic and piezoelectric materials allow the device to generate energy regardless the speed of motion and it can be driven by very low torque movements. The need for rotating movement made this harvester unsuitable for the localized tag's supply.

A thermoelectric energy harvester^[20] is based on the working principle of the Peltier effect, where a temperature difference between two surfaces of a Peltier cell generates a current flow. This harvester requires a minimal temperature difference between the two surfaces, which can be maintained using a heatsink on one side and a constant temperature surface on the other. The dimension of the heat dissipation device and the lack of a constant temperature surface determines the non-compatibility with a portable tag.

Vibration-driven energy harvesters^[21] are commonly formed by a spring-mass device, where the beam that plays the role of spring is covered by a piezoelectric layer that translates the generated strain at resonance to a piezoelectric voltage. This voltage produces a charge current in the load, generating electric power. This device needs a tuning of the resonant frequency from the inherent variability of the most common ambient vibrations. Even though the tag could exploit the vibration produced by a walking person, the relative energy generated would be very low, since the duration of the person's movement is limited, also making this harvester non-optimal for the supply of the tag.

A non-resonant mechanical energy harvester collects energy from random, low-frequency, tiny mechanical vibrations in daily life using piezoelectric materials designed for this purpose^[22]. The available energy predicted on the movement of a key fob is too small to allow a localization event of the tag, so this harvester was not included in the localization system.

The Photovoltaic Cell (PV-Cell) developed in the scope of the EnSO project is tuned for the indoor light of an office environment and can provide up to 57 μ A at 5.2 V (for 1.000 Lux), depending on the lighting conditions^[23], allowing it to accumulate enough energy for a localization event of the tag. The selected PV-Cell has the physical dimensions of 54 mm x 26 mm and is composed of two blocks in parallel of two cells in series.

¹⁸ R. Mazraani, M. Saez, L. Govoni, D. Knobloch, "Experimental Results of a Combined TDOA/TOF Technique for UWB Based Localization Systems", DOI 10.1109/ICCW.2017.7962796, *IEEE International Conference on Communications Workshops, ICC*, May 2017.

¹⁹ Enerbee -Grenoble, France - <https://www.enerbee.fr/?lang=en>.

²⁰ Mahle Thermoelektronik GmbH, Duisburg, Germany - <https://www.mahle.com/de/about-mahle/locations/1210.jsp>.

²¹ L. Mateu, J. Knauer, P. Spies, H. Zessin, Autonomous Tuning Methods for Piezoelectric Energy Harvesting Generators, *AMA Conf.* 2017 , 540–545 (2017).

²² Kim HS, Lee DW, Kim DH, Kong DS, Choi J, Lee M, Murillo G, Jung JH. Dominant Role of Young's Modulus for Electric Power Generation in PVDF-BaTiO₃ Composite-Based Piezoelectric Nanogenerator. *Nanomaterials* (Basel). 2018 Sep 30;8(10):777. doi: 10.3390/nano8100777. PMID: 30274363; PMCID: PMC6215192.

²³ Solems – L'énergie Lumière, 3 rue Léon Blum, FR-91120 PALAISEAU, www.solems.com/en/.

An additional energy source included in AMES, a Near Field Communication (NFC) antenna^[24], has been used to transfer power from an emitting antenna to the AMES battery. This solution is practical in that, in the case of lack of energy, the energy harvesters and can provide a data link.

The tag powered by the AMES battery without any energy harvester, working with a localization frequency of 1 Hz, has an autonomy of 30 days. If a PV-Cell is also connected in good indoor lighting conditions (650 Lux), with continuous light presence; the autonomy is computed to be up to 600 days.

The power consumption can be further optimized by adding an accelerometer to the tag. Although the MEMS component would require some energy, it is balanced by the advantage it brings, i.e. the ability to tune the localization frequency with the accelerations that indicate a movement of the tag itself. This would allow massive reductions in unnecessary localization events, drastically increasing the battery duration of the tag itself, making it virtually self-sufficient.

In conclusion, the development of the energy harvesters should continue in both vertical and horizontal directions. On one hand, every possible energy source as input for a harvester should be investigated. On the other hand, the efficiency and the net amount of energy made available should be significantly increased. Although the IoT systems are small and low power rated, the amount of energy needed for basic functionalities, like wireless data transmission, data acquisition at high frequency, and user interfacing; still require a greater amount of energy than the level currently available with energy harvesting. Nevertheless, some applications, where basic functions are required and where the energy consumption can be strongly reduced and/or optimized, showed the potential for energy-independent systems available for ongoing digitalization, such as ambient parameter sensing (temperature, air quality, humidity, etc.).

3.4. Railway Infrastructures

Authors: Zdenek Hadas, Otto Plasek

Quality of service and safety systems are continuously being improved for current and future railways. Reliable and low-maintenance power supplies are essential prerequisites for a number of services linked to an electric infrastructure. Electrical power for these systems could be delivered from the electrical grid's catenary in both on-board and wayside infrastructures. There are still remote or difficult access wayside areas where electrical infrastructures are poor, and where renewable energy sources like solar panels or wind turbines could be used. In addition, other energy harvesting sources are discussed for railways applications^[25].

Many stakeholders (e.g. infrastructure managers, rail freight operators, manufacturers and suppliers of technologies, or railway authorities) are involved in the migration to alternative power sources to achieve economically efficient technology by using renewable and energy harvesting resources. A significant reduction of the life cycle costs of future railways is expected through the elimination of cabling, which is expensive, subject to theft, and difficult to maintain (especially in the case of changes in the trackside layout).

Solar panels and wind turbines could be used with low-maintenance battery or other back-up power supplies (e.g. fuel cells) to meet safety requirements. Most railway equipment must be certificated for continuous operation with a probability of dangerous failure on a safety integrity level (SIL4). Hybrid renewable sources should achieve this level of risk-reduction for continuous operation with appropriate energy storage elements.

The discontinuous nature of energy harvesting carries certain risks in the way the electric equipment is powered by energy harvesting. There are two potential situations when the device power consumption is lower than the average harvested power (continuous operation is enabled) or the power consumption of the device is higher than the average harvested power (the discontinuous operation is dependent on the stored energy).

²⁴ Bouřa, Adam & Husak, M. (2012). Communication and Powering Scheme for Wireless and Battery-Less Measurement. *Radioengineering*. 21.

²⁵ doi 10.1680/jtran.16.00016.

In the case of energy harvesting technologies, the harvested power is usually low and this technology is not capable of covering all power requirements of current railway systems, which are very power-hungry. Significant reduction of power consumption by employing a new generation of electronics and communication technologies could provide a new generation of smart wayside objects and controllers on railways, which should integrate energy harvesting technologies. Nevertheless, there are still questions about the required safety integrity level for this critical application.

On the other hand, several communications systems do not have such safety requirements and provide useful information about traffic and infrastructure conditions. The reporting, monitoring, and diagnostic systems are widely used in many industrial branches in the last decade due to significant growth in wireless technologies. The increasing demand on electronic devices is an important driving force for designing a cost-effective and reliable power supply solution for railway infrastructure electronic devices. Employing modern electronic equipment of railway infrastructure provides an opportunity for a wide employment of energy harvesting technologies.

3.4.1. Motivation in Railways

Preventative or scheduled maintenance has been used in railways for the last decade, where failures were detected only by periodic inspections to reduce breakdown occurrences. Condition monitoring with deployment of modern electronics is based on a long-time sensing of system functional parameters (e.g., deformation, vibration, or temperature) to detect significant changes that involve wear, anomalies, or system degradation. This type of monitoring and diagnostics is defined as condition-based maintenance and presents significant improvements in preventative maintenance, performing the corrective actions when a failure is detected. It enables predictive maintenance actions in advance of the failures, which provide a significant cost saving.

Energy harvesting technologies could be integrated into both on-board^[26] and trackside^[27] environments for monitoring, reporting, and diagnostic applications. In on-board applications, most sensors and electronic equipment can use direct powering from the on-board grid. However, a catenary from the on-board electrical grid is not effective for retrofitting wireless sensors or sensors in the undercarriage area.

In the trackside, a catenary from the wayside's electrical grid, infrastructure could be difficult due to the restriction of infrastructure managers and operators. Regional railways include remote wayside areas where electrical infrastructures are poor or access to cable installations difficult (e.g. tunnels^[28]). Therefore, installing the modern electronic equipment for future railways (e.g. track circuits, axle counters, passing detectors of a train between two points on a track, etc.) could be required in areas where it was not previously available due to the lack of energy supply. The installation of such train detection systems and communication links between control centers and controllers represent a high cost for infrastructure managers. An installation and operation of condition monitoring and reporting electronic systems (e.g. track-health monitoring systems, wireless sensors, bridge/timber bearer/switch monitoring, etc.) could be costly in both cable and installation costs^[29]. Energy harvesting technologies could save costs in both operation and installation costs and it could improve the quality of services and safety systems for future railways.

3.4.2. Deployed Energy Harvesting Technologies and Potential for Future Development

Energy harvesting technologies use physical principles to convert ambient energy into useable electricity. Railway is a source of many forms of ambient energy that could be successfully used for wireless sensor nodes and autonomous systems. The main source of ambient energy is the moving train in both on-board and trackside environments. There are significant on-board vibrations on most trains that could be converted and used for a wireless sensing. Most freight cars have no power and the vibration energy harvester allows monitoring without deployed primary batteries.

²⁶ doi 10.1051/mateconf/201814812004.

²⁷ doi 10.1016/j.apenergy.2017.04.064.

²⁸ doi 10.1109/INFCOMW.2013.6562850.

²⁹ doi 10.1061/(ASCE)BE.1943-5592.0000608.

Perpetuum, a company from the UK, provides vibrational energy harvesting technology for industrial applications, which can be used to monitor valuable equipment and assets across a wide variety of industries. Its vibration electromagnetic-energy harvester is optimized for train operation and allows self-powered wireless sensing technology for real-time bearing monitoring and wheel wear in trains. Under European Shift-2-Rail projects (X2-Rail-2 & ETALON), this type of energy harvesting technology could be used for on-board train integrity application, which could be important for freight train operation in high traffic density agglomeration.

The trackside environment provides several potential energy harvesting applications, including wind and solar energy, mechanical energy from vibration, rail deformation and sleeper or rail sag under passing trains^[30], as seen Figure 25. These technologies were analyzed in detail under the European Shift-2-Rail projects X2-Rail-1 & ETALON. Relative displacements of sleeper against trackbed (type 1), rail sag against trackbed (type 2), rail against sleeper (type 3), and displacement of individual sleepers (type 4) could be harvested using several types of electromechanical linear generators. In addition, the mechanical vibration of sleeper (type 5) and rail (type 6) could employ physical principles of vibrational energy harvesting methods. The passing train locally deforms the rail and it could be converted into electricity (type 7). The passing wheel could also run over a flexible element that provides kinetic or potential energy into a linear generator (type 8). Energy harvesting systems could use a change of the magnetic field by the wheel passing, which can induce electrical energy (type 9).

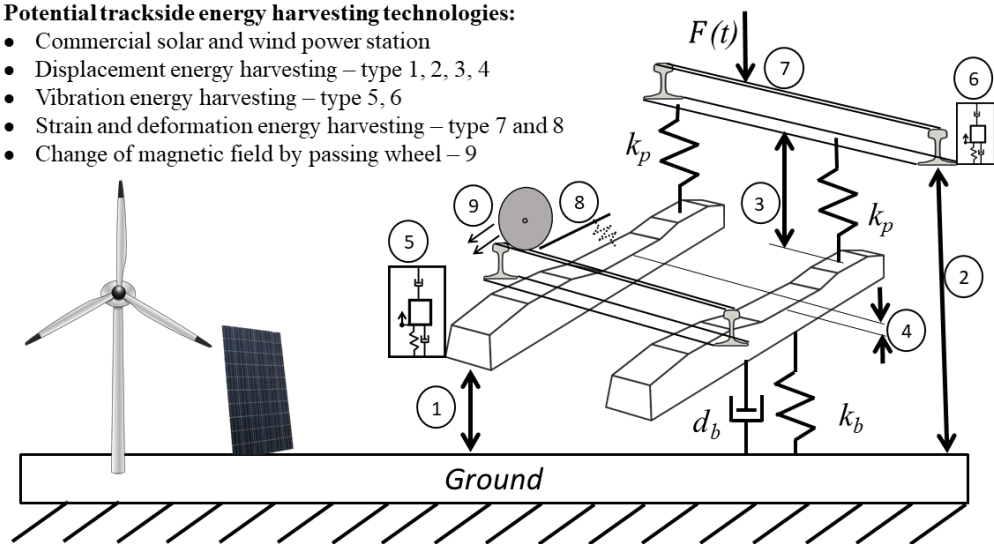

Figure 25 — Potential Energy Sources on Trackside for Energy Harvesting

A critical railway infrastructure and related field elements, such as signaling and object controllers, requires safety in SIL4. These devices are usually power-hungry, but could be used with solar and wind power sources with optimized energy storage elements. Greenrail, a start-up company, produces a solar sleeper that integrates photovoltaic cells. There is a potential to transform every kilometer of the track into a photovoltaic field, producing power outputs in the range of 150 kWh to 600 kWh. However, the position of photovoltaic cells on the sleeper top is not efficient. The PV cells on the top of the sleeper have a dirt problem and the cells can also be damaged during the traffic operation.

A huge number of trackside sensors could use the ambient mechanical energy of passing trains. Displacement, strain, and vibration energy harvesting converters could be effectively used on trackside applications. The physical principles of piezoelectric and electromagnetic energy conversion are widely analyzed in the case of passing trains. The Greenrail Piezo sleeper incorporates a piezoelectric system and dynamometers that activate themselves at every train passing. This harvesting energy system will power integrated systems for analysis and diagnostics of the railway line; however, details and performance of this product are not published yet. The electromagnetic trackside energy harvesting technologies are widely presented in piezoelectric research. ReVibe uses vibrational energy

³⁰ doi 10.1051/mateconf/201821105003.

harvesting technology with output power up to 200 mW to power of sensors attached to the railway track. This technology is ready to use for remote monitoring of trackside and off-grid objects and it could operate autonomously without spending extensive resources on replacing batteries.

The trackside vibration energy harvesting solution is under the worldwide development of academics and several hundred research papers were published in last decade. Many analyses, devices, and systems and their potential for wireless sensing, condition monitoring, and predictive maintenance was presented and highlighted in publications^[31].

Displacement energy harvesters^[32] convert a relative movement of rail/sleepers to trackbed or mutual movements into electricity. In addition, a displacement harvester based on contact of passing train wheels was analyzed under the European Shift-2-Rail ETALON project. Several preliminary prototypes of mechanical rectifier-based harvester were developed and tested. However, mechanical transmission parts' operation is sensitive on a load/train speed, so this kind of energy harvesting principles is suitable only for regional tracks or freight transportation with lower maximum speed. The main issues for all displacement harvesters are the precise installation and reliability of mechanical transducers, mainly devices with mechanical contacts that need preventive maintenance. This issue will erase the benefits of energy harvesting applications for predictive monitoring^[33].

A bulk electromagnetic vibration energy harvester for sleeper application^[34] that was developed under the European Shift-2-Rail ETALON project was successfully tested with a real vibration under passing trains in a lab condition. This device is able to provide the required power for remote sensing and wireless communications. A successful operation with the LoRa module was presented and provides an opportunity for future railway applications. This device is capable of being integrated into new generations of sleepers and bearers. Additive technology for the massive manufacturing of modern sleepers and bearers are discussed and the combination of both technologies could provide a new generation of smart sleepers or bearers with embedded sensors and energy harvesters. It could be deployed for bridge sleepers and timber bearers manufactured by additive technologies. Moreover, energy harvesting devices could be integrated into a plastic sleeper, as was presented by Greenrail.

3.4.3. Key Elements for Trackside Energy Harvesting Development

The key element of energy harvesting devices is to deliver the required power in operation time. Replacing cables and cut-off railway equipment from the power grid and using an energy harvesting source is not an optimal solution and is often impossible. Energy harvesting devices are a specific power source and the whole system of feasible equipment with energy harvesting sources must be developed together to significantly reduce of the power consumption with the required reliability. It leads to the long-term deployment of energy harvesting devices with a new generation of smart railway objects for sustainable rail transportation.

The vibration energy harvester's response in the trackside environment depends on several aspects, including track dynamics, quality and wear of the track, train load and speed, and wear of train components. Two trains in the same place and conditions could generate significantly different power responses and one train could provide different responses on two places along the same track. The response could also be different in time where weather conditions, e.g. humidity and temperature, change the properties of track stiffness. In this case, the long-time vibration measurements are fundamental for the appropriate design of all mechanical energy harvesters. The data must be analyzed and a developed system should provide the required power for sensing under all passing trains^[35]. However, the measurements and historical data are typically protected by intellectual properties because it was recorded during the testing process of new cars and types of field elements.

Another issue is related to tests of developed energy harvesting systems. Only certificated devices could be used under regular traffic. Administrative exceptions for tests of experimental energy

³¹ doi 10.1109/TITS.2016.2611647.

³² doi 10.1016/j.enconman.2016.04.012.

³³ doi 10.1109/MESA.2012.6275532.

³⁴ doi 10.1007/978-3-030-19519-9_8.

³⁵ doi 10.1016/j.ymsp.2018.01.007.

harvesting devices could be a serious problem in several European countries; usually, the only short-term test could be available based on agreements with infrastructure managers. The long-term test now appears to be problematic for these developed systems in the European railway network. Testing on a specific private track or railway test rings is not relevant for wide applications due to the specifics of both cases. For these reasons, the implementation of energy harvesting systems in the short term is difficult. The long-term test must clearly determine the feasibility of energy harvesting devices in trackside for the next railway implementation of this technology.

Several railway infrastructure manufacturers (sleepers/bearers, switches and crossings, axle counters, etc.) have begun to seriously consider the development of new equipment with energy harvesters for the predictive maintenance applications of their products. There are two work streams: retrofitting and innovation of products. Both provide main advantages of energy harvesting devices that represent a cable reduction (in both communication and power), decreasing of costs from cable theft, decreasing costs for the energy power supply or replacing batteries. All these aspects lead to the significant reduction of maintenance costs. This fact is amplified by applying predictive maintenance methods that replace periodic inspections to prevent breakdowns.

A new generation of smart sleepers could detect overloaded trains or trains whose wear of wheels or suspension systems provide a significantly higher load to the track and rapidly increase rail track wear. The wear of track or significant change of substructure properties, e.g. gap under sleeper, could also be detected by a smart monitoring system embedded in sleepers. This maintenance system could be interesting for infrastructure managers and freight train providers to detect wear or damage of both track and trains. However, extensive research has to be done for the development of predictive maintenance algorithms and artificial intelligence methods may be employed for these big data tasks. The comprehensive monitoring system could solve a sensitive question if freight cars are worn due to poor track quality or vice versa, a damaged freight car in operation wears the track. There is a question if infrastructure managers and providers need general Data Protection Regulation agreements because the response of individual train sets could produce data about the condition of individual trainsets and fleet of individual providers.

3.4.4. Conclusions

Railway, by its nature, provides a very interesting source of ambient energy for energy harvesting technology in the form of a passing train. Energy harvesting technology could provide an opportunity for future railways with significant maintenance cost savings. This is mainly in material costs, installation costs, maintenance costs and cost occurring because of cable thefts. The development of energy harvesting technologies is not fully exploited in railways now. This comes from a misunderstanding of energy harvesting technologies where a simple cable cut off and installation of energy harvester into current infrastructure is not technically realized. However, mature energy harvesting products show that this technology is feasible also for retrofitting and can provide a significant cost reduction in case of predictive maintenance. Integration of energy harvesting technologies into a new generation of smart self-monitoring infrastructure equipment will certainly lead to large maintenance cost savings.

Many universities have been involved in energy harvesting technologies for more than 15 years and many energy harvesting solutions can be adopted in railway applications. For the successful development of energy harvesting technologies in railways, data sharing between involved stakeholders and the academic sphere is very important. After that, cooperation in real environment tests will lead to the design of effective energy harvesting systems that reliably provide power to smart systems and significantly increase their reliability.

3.5. Healthcare

Authors: Neus Sabaté, Jordi Colomer-Farrarons, Pedro Miribel-Català

Applications based on harvesting systems as the main power source have grown considerably, largely due to the extensive use and increase in IoT technologies. This increase in harvesting technologies has generated interest in areas initially far from these elements, opening the door to new possibilities for future developments.

The medical industry (healthcare) is one of the areas that has started to evaluate the use of energy harvesting sources and explore new niches and applications for its potential use. In a first approximation, applying a harvesting source as the main energy generator for a medical system or equipment presents numerous impediments that limit direct use, especially for those close to the patient, such as respirators or heart monitors. This is due to the importance of a guarantee of continuous and uninterrupted energy and, above all, the fulfillment of the strict safety requirements.

The fact that the energy generated by the harvesting source depends solely on the environment already represents a very high security risk that greatly limits the ability to overcome strict regulations (such as IEC 62368 or the IEC 60601). Much of this equipment is used in controlled indoor environments where factors such as temperature changes, access to sunlight, flows, or vibrations are difficult to access for those harvest sources that generate energy from them.

Likewise, medical products must incorporate protection systems to avoid possible electrocutions known as Means of Protection (MOP). A medical device must incorporate at least one protection (MOP) to guarantee that both the patient and the operator are protected from any fault condition or electric shock.

The device must achieve protection through safety isolation, protection earth, a creepage distance, air gap, other protective impedances, or a combination of these techniques to guarantee the levels of isolation, types of isolation, leakage levels, and other features required in IEC 60601. Potential risks from the harvesting source should be thoroughly analyzed by conducting a formal risk assessment process, as defined in ISO 14971, to determine the likelihood of a patient coming into contact with the device and suffering some damage.

In this sense, harvesting-based power sources should incorporate some of the protection mechanisms for avoiding the loss of effectiveness in their transduction and maintaining their energy efficiency.

Despite the inherent limitations in current technologies for the development of harvesting sources as the main element of power for medical devices, new opportunities open up to maximize some of the harvesting characteristics and develop new architectures and topologies that allow going further beyond the current devices and envisaging future applications.

In a first approach, following this line of research for new health applications, one can find Point of Care (POC) systems or platforms with low or very low consumption, focused on developing theragnostics applications or diagnostic devices. A patient-centered scenario is presented where the POC equipment allows obtaining a set of essential measurements locally and comfortably, without the patient needing to travel to the hospital.

These compact POC applications have numerous advantages for the patient, for the healthcare provider, for the government or health funder, and clinical and technology benefits. These include convenience, adapting to different diagnostic and monitoring tests, ease of use, quick diagnostics, specific and appropriate treatment, and reduced and controlled power consumption to extend operating cycles and recharge periods, which can benefit from external harvesting sources as the main power supply source.

Furthermore, this type of approach to POC devices powered by a harvesting source may be well suited to the WHO's ASSURED (affordable, sensitive, specific, user-friendly, rapid and robust, equipment-free, and deliverable) criteria. A clear example would be a diagnostic system fed through an RF link (or mobile phone) that allows, at the same time, feeding and transmission of the information.

A step beyond the aforementioned POC devices, a promising area points to mixed or hybrid scenarios where the harvesting source operates with a sensor element to develop a self-powered application. This approach can extend the energy sources to other non-usual sources, such as fuel cells.

Particularly interesting is the plug-and-power model. A disposable test strip contains the sample to be analyzed and a disposable tiny battery that generates the electrical power used to run an electronic reader. This renders the electronic module energy independent, a feature that is very convenient in poor resource settings^[36].

Another example of the use of fuel cells as power sources for PoC devices is shown in a platform that contains a smart interfacing circuit to operate an ultra-sensitive electrolyte-gated field-effect transistor (EGOFET). The sensor is powered by a paper-based biofuel cell (BFC) that extracts energy from the analyzed sample itself^[37]. These examples are the foundations of the self-powered biosensors to come.

Among the most important challenges that these approaches face before reaching the market, is the low voltages. It is worth highlighting that self-powered sensors usually yield voltages below 1.0 V, which introduces the need for charge pumps if off-the-shelf electronic components are to be used or sub-volt ASIC solutions needed that increase their cost. The achievement of reproducibility and variability are also important barriers that are also faced by biosensors in general.

Likewise, some recent works envisage developing new architectures, circuits, and electronic systems that go beyond energy harvesting as a power source and open the door to duplicate the functions of a harvesting element working as a power source and sensor (measurement) element at the same time for health and other industrial applications.

This scenario has been derived as a change of point of view to cope with self-powered systems. In this novel paradigm, the electronics solution is not derived only from fulfilling the power management of the harvested energy to power a system, such as a POC or wearable biomedical applications. In this case, the source can be of different nature, such as a fuel cell or a thermoelectric generator, and is not perceived just as a powering energy unit, but also conceived as a sensing element.

The concept has been applied in other engineering fields, like smart health monitoring for structural systems and aeronautics. In this scenario, a piezoelectric generator is used as an energy harvester unit by converting the mechanical vibrations to electrical energy to drive full electronics for a self-powered monitoring mote. Simultaneously, using techniques like a time-multiplexing solution, the open-voltage circuit (V_{OC}) generated by the piezoelectric transducer is used to sense the material's strain, which is related to the material stress.

The previous concept includes a specific electronics solution to create new health or environmental applications. The solution presented in the paper "Ubiquitous Self-Powered Architecture for Fuel Cell-based Point-of-Care Applications"^[38] enables efficient power extraction from the cell as a power source. At the same time, it can extract a measurement from the cell, as a sensor, for cases using ethanol, lactate, or methanol-based fuel cells extracting the concentration of the sample.

These enabling technological electronics solutions open a new framework beyond harvester solutions to health-care applications with low power consumption, just 36 μ W. This approach does not need a classical potentiostat architecture, which reduces system complexity, to fix the cell potential for the biosensor because the same management is used to settle this operating potential, with a quick start-up (0.5 s) and a reasonable sensitivity of 158.0 mV M⁻¹.

In those scenarios where the generated energy is even lower (5.8 μ W), the platform is conceived as an event-detector, as presented in work "Self-Powered Point-of-Care Device for Galvanic Cell-Based Sample Concentration Measurement"^[39]. It has the capability to fix, sense, and generate a test result without the use of a potentiostat amplifier and complex use of micro-controllers or timers with the use of a fixed value that can be adjusted by the galvanic cell properties to be detected.

³⁶ <http://dx.doi.org/10.1016/j.bios.2018.07.034>.

³⁷ <https://doi.org/10.1016/j.bios.2020.112103>.

³⁸ doi 10.1109/TIE.2020.3029484.

³⁹ doi.org/10.3390/s21082665.

The use of electrochemical power sources as self-powered sensors seems to be particularly suitable for short-term use applications such as single-use POC devices or wearables. These approaches have to overcome two important challenges: the tiny amount of power generally produced by these components has to be quantified without using any additional power source; and signal management is to be performed with a minimal number of electronic components so the final solution is cost-effective and eco-friendly.

Besides price, the final approach's sustainability is highly relevant as the upcoming generation of digital diagnostic devices must not contribute to the alarming increase of electronic waste currently being generated worldwide. In this sense, the evolution of printed electronics-related technologies allows envisaging fully printed POC smart devices manufactured in medium to low energy consuming roll-to-roll equipment.

Yet paper, as a key material to implement biosensors, has proliferated as a compliant way towards device sustainability and affordability. Departing from commercial paper-based dipsticks (urinalysis dipsticks) and lateral-flow immunoassays (pregnancy tests), materials used in lateral flow devices have been adapted and reconfigured in 2D or 3D paper matrices. This has led to creating new and exciting components: valves, mixers, and separators that do not require any power or ancillary devices. These features have been recently successfully combined to create a single-use self-powered skin patch that uses a paper battery to measure sweat conductivity^[40].

⁴⁰ <https://doi.org/10.1038/s41378-018-0043-0>.

4. Key Advantages

Editor: Bahareh Zaghari

Authors: Bahareh Zaghari, Oktay Cetinkaya, Viktor Borjesson, Dominik Samson, Alexandros Elefsiniotis

Progress in energy harvesting (EH) has a direct effect on the implementation of the billions IoT devices. With the increasing number of devices, adopting EH can greatly contribute to achieving net-zero carbon emissions by 2050. The EH systems market was valued at USD 440.39 million in 2019. It is expected to reach USD 817.2 million by 2025 at a compound annual growth rate (CAGR) of 10.91% over the forecast period of 2020-2025^[1].

EH in IoT applications has been highlighted in discussions around Industry 4.0 and digital transformation. In the last 2-3 years, many energy-efficient manufacturing and production systems for digitalization were developed. The number of companies adopting digital transformation and wireless monitoring powered by EH solutions in their products has increased and inspired several publications in this area^[2].

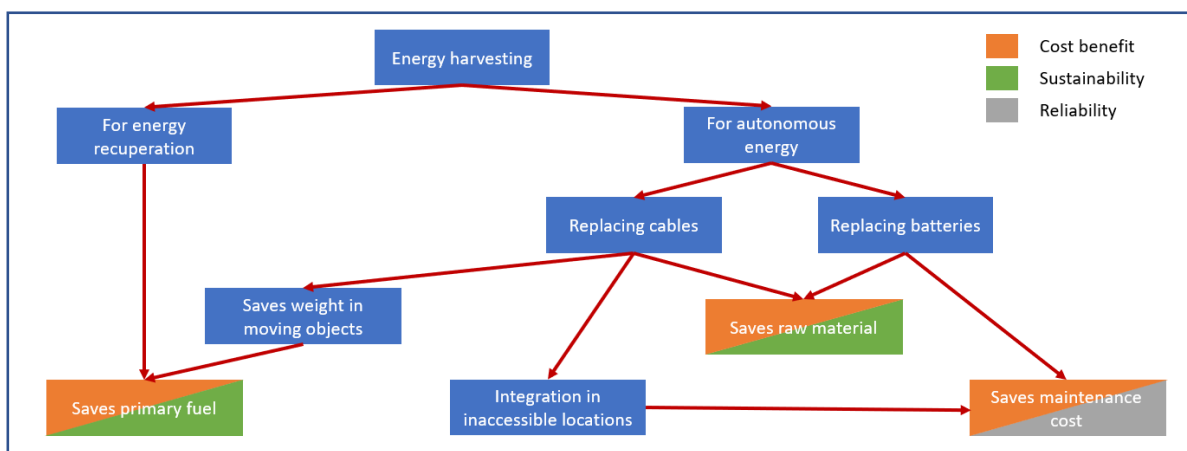

Figure 26 — Assigning the Advantages of EH to Key Areas: Cost Benefit, Sustainability, and Reliability

Advantages of EH are considered mainly in three areas: cost benefit, sustainability, and improved reliability. Figure 26 shows the benefits of EH for most applications in autonomous systems and for energy recuperations. Reducing maintenance and primary fuel costs as well as reduction in using raw material (where cables and batteries are eliminated) may lead to a sustainable solution. Reliability of EH devices are compared to battery-powered systems based on energy availability and the increase in the number of nodes to improve accuracy of data collection.

4.1. Cost Benefit

Remote monitoring with low-power devices powered by EH can eliminate breakdowns and productivity losses or provide the necessary data to create new business models. The impact of remote monitoring has been in efficiently identifying failure, increasing lifetime, and saving maintenance costs in aerospace, railway, mining, construction, and similar industries^[3,4,5]. EH solutions have had a great impact where remote monitoring of inaccessible parts and tracking of the assets are needed. Choosing energy harvesters over batteries or long cables for power and data transmission can reduce the overall costs. This is due to reducing operating, maintenance, and installation costs and longer lifetime. Continuous access to sources of energy (vibration, light, etc.) and low-power operation of IoT devices enable using energy harvesters over batteries.

¹ <https://www.mordorintelligence.com/industry-reports/energy-harvesting-system-market>.

² <https://ijaers.com/detail/energy-efficiency-in-the-context-of-industry-4-0/> paper: Energy efficiency in the context of Industry 4.0.

³ <https://ieeexplore.ieee.org/abstract/document/8979443><https://ieeexplore.ieee.org/abstract/document/8979443>.

⁴ <https://doi.org/10.1016/j.apenergy.2021.116512><https://doi.org/10.1016/j.apenergy.2021.116512>.

⁵ <https://doi.org/10.3390/s18124113>.

Remote sensing in smart grids for smart meters, operational control mechanisms, load balancing mechanisms, and fault-tolerant mechanisms can be used for efficient and reliable power delivery to the end user. For detecting fires, heat, or potential disasters at an early stage and ensuring the safety of electricity; real-time online condition monitoring of the indoor power line is necessary. More detailed and accurate data on energy consumption in homes, offices, and factories can be achieved by deploying a network of wireless sensors^[6]. Maintenance and replacement of batteries across meters and sensors in the network contribute dramatically to the extra life cycle costs of a smart grid network. This creates an opportunity for sensing devices powered by EH technologies. Using self-powered devices in smart meters and industrial sub-stations can dramatically reduce the ongoing costs of running the smart grid^[7].

The cost-benefit of EH devices can be found by analyzing the available harvested energy, the energy consumption of the device (which depends on the data type that should be collected and communicated), and the limitation of the application (limited space, accessibility, and replacement costs). If an abundant source of energy is available to be harvested, a device can be connected to the harvester, even without energy storage. In this ideal case, the reduction of electrical elements reduces the cost. However, in most applications, the energy source is limited and a power management system with low-power circuits and computing in the edge (i.e. in the IoT node) is needed to avoid sending a large amount of unprocessed data. The cost-benefit of a battery-powered device over a device with energy harvester depends on several criteria, which are highly dependent on the application. For example, the data calculated by ReVibe Energy^[8], a company with expertise in vibration energy harvesting devices, illustrates the total cost of ownership when using vibration EH versus using batteries in Table 13.

Table 13 Comparisons between a VEH from ReVibe Energy and Off-the-Shelf Batteries

<i>Source</i>	<i>ReVibe Energy (EUR)</i>	<i>Batteries (EUR)</i>
<i>Purchase</i>	<i>40 - 350</i>	<i>40</i>
<i>Installation</i>	<i>45</i>	<i>45</i>
<i>Hourly rate & labor costs</i>	<i>0</i>	<i>1165</i>
<i>Replacement</i>	<i>0</i>	<i>240</i>
<i>Inventory costs of spares</i>	<i>0</i>	<i>225</i>
<i>Lost productivity</i>	<i>0</i>	<i>290</i>
<i>The total cost of ownership</i>	<i>85 - 395</i>	<i>2005</i>

The difference between the two options is mainly related to the cost of the device and maintenance, which is highly dependent on the application and the operating environment. In general, energy harvesters are more expensive than batteries, but their cost is offset by reduction in replacement costs.

4.2. Reliability

The reliability of an EH device can be defined as the probability that a device will perform a required function under specified conditions for a certain period of time. Higher customer satisfaction, increases in sales, improvement in safety, and reduction in maintenance are desirable outcomes of a reliable system. In the design process of an EH device, measurement of reliability and failure rates, can be carried out. The number of devices that did not fail under specified tests over the total number of devices tested, for a given time, represents the reliability of the device. Reliability and stability trade-offs of EH can be defined from the nature of available energy, EH device, storage, power management system, and self-powered sensor deployment. The reliability of an EH device is

⁶ <https://doi.org/10.1016/j.apenergy.2018.09.207>.

⁷ <https://ieeexplore.ieee.org/document/8514966>.

⁸ <https://revibeenergy.com>.

compared with a battery-powered device in safety critical systems. Reliability of EH devices in comparison with batteries can be assessed based on design parameters and figures of merit (energy density, efficiency...)^[9].

Due to the stochastic nature of the energy source, designing a reliable energy harvester is challenging. The unpredictable nature of natural energy sources has inspired researchers to design broadband and nonlinear energy harvesters to capture the behavior of the source.

The reliability of an energy harvesting device is not only based on the success-to-failure rate in producing sufficient energy for energy storage; it is also related to uncertainty in harvesting energy. Uncertainty analysis of EH systems for a vibration energy harvester can be found from excitation characteristics, parameters of vibrational energy harvesting systems, and power output^[10].

The reliability of energy storage can be defined based on comparing different energy storage types and sizing^[11]. The power management system, which controls the energy distribution, can also help improve the reliability of an energy harvester by selecting an appropriate strategy at different conditions. The integration of power management systems to an energy harvesting device can result in controlling the energy demand from the load and contribute to a reliable system.

Long-term power degradation of an EH device can be a result of a damage in the coupling between the device and the source, which can affect the reliability of the device. The “self-healing systems” concept is adopted in a number of research fields and activities, such as electronics or mechanical design. Resilience against damage, a level of redundancy to maintain part of functionality after a failure has occurred, or the ability to regain functionality through the ability of self-repair or reconfiguration can improve the reliability of the devices^[12,13].

Standardization of EH devices can influence the price, integration into different applications, and compatibility between components (sensors, storage, transmission, and processing)^[14]. Proprietary standards, on the other hand, can form an obstacle to the rapid adoption of EH solutions. Proprietary wireless, data storage, and power transfer standards create an obstacle customers face. Furthermore, hardware security and integrated solutions have not been standardized for EH devices.

4.3. Sustainability

Energy harvesters make the economy greener by reducing reliance on batteries, but the environmental footprint of energy harvesters must also be considered. Research on life cycle analysis of energy harvesting devices, which aims to calculate a product’s environmental footprint across a range of impacts, is currently missing in the literature. In most applications, the operating life of EH devices is limited by their energy storage, such as rechargeable batteries or supercapacitor’s life span. Life cycle analysis of batteries has been studied^[15] and specific battery design and production solutions have been suggested to reduce the environmental footprint of batteries. However, the life cycle assessment of the different type of energy harvesters, as well as the energy management systems, has been focused on material selection^[16]. Moving away from the material selection, application selection is

⁹ Schertzer, E. and Riemer, R., 2015. Harvesting biomechanical energy or carrying batteries? An evaluation method based on a comparison of metabolic power. *Journal of Neuroengineering and Rehabilitation*, 12(1), pp.1-12.

¹⁰ Madankan, R., Karami, M.A. and Singla, P., 2014, August. Uncertainty analysis of energy harvesting systems. In International Design Engineering Technical Conferences and Computers and Information in Engineering Conference (Vol. 46391, p. V006T10A066). American Society of Mechanical Engineers.

¹¹ Jackson, N., Adkins, J. and Dutta, P., 2019, April. Capacity over capacitance for reliable energy harvesting sensors. In Proceedings of the 18th International Conference on Information Processing in Sensor Networks (pp. 193-204).

¹² Farnsworth, M. and Tiwari, A., 2015. Modelling, simulation and analysis of a self-healing energy harvester. *Procedia CIRP*, 38, pp.271-276.

¹³ Frei, R., McWilliam, R., Derrick, B., Purvis, A., Tiwari, A. and Serugendo, G.D.M., 2013. Self-healing and self-repairing technologies. *The International Journal of Advanced Manufacturing Technology*, 69(5-8), pp.1033-1061.

¹⁴ Research Infrastructure Position Paper, European Infrastructure Powering the Internet of Things: https://www.enables-project.eu/wp-content/uploads/2021/02/EnABLES_ResearchInfrastructure_PositionPaper.pdf.

¹⁵ Battery law can help Europe become green battery powerhouse, <https://www.transportenvironment.org/press/battery-law-can-help-europe-become-green-battery-powerhouse>.

¹⁶ Ibn-Mohammed, T., Reaney, I.M., Koh, S.C.L., Acquaye, A., Sinclair, D.C., Randall, C.A., Abubakar, F.H., Smith, L., Schileo, G. and Ozawa-Meida, L., 2018. Life cycle assessment and environmental profile evaluation of lead-free piezoelectrics in comparison with lead zirconate titanate. *Journal of the European Ceramic Society*, 38(15), pp.4922-4938.

essential for investigating further the sustainability of the overall system. Energy harvesting offers a lot of advantages in the field of intermittent operating applications, as shown in Figure 27.

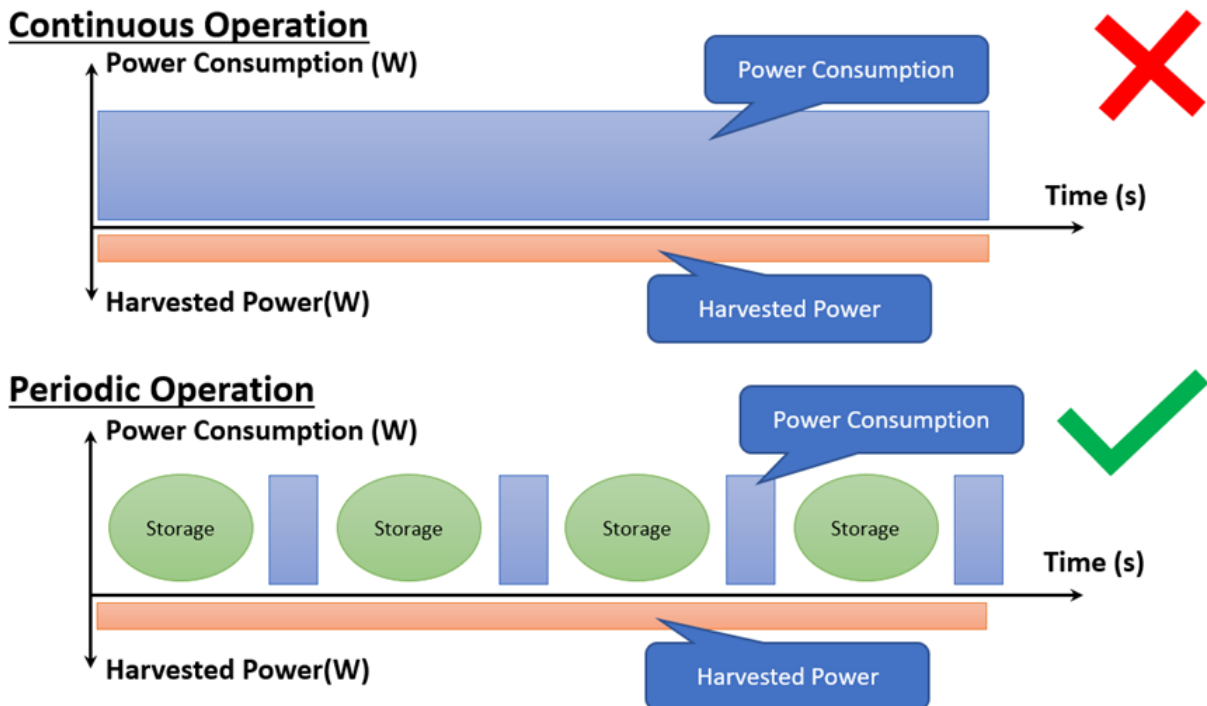

Figure 27 — Continuous vs. Intermittent Operation of a Device with an Energy Harvester (Adapted from^[17])

Long-term use of energy harvesting devices with deployment of sensors for potential applications not currently possible is one of the advantages of EH and its contribution to sustainability. In healthcare, for example, a smart bandage that can run for a month instead of a few days (no clinic visits needed) or smart cities with health monitoring devices can extend the maintenance time. However, the combination of energy harvesting devices with batteries and supercapacitors is still necessary in most of the applications. The main advantage is that the system is not stressed and the storage capacities have a longer lifetime as the number of cycles is increased due to the shallower recharging during idling. In a more macroscopic view, the reduction of the toxic and rare materials necessary to produce batteries is also realized. In this sense, IoT applications provides such advantages.

Remote self-powered devices used for pollution monitoring have enabled better decision making and more reliable strategies for transportation in smart cities^[18]. Air pollution particles are found in most remote places and land on ice and snow, where they darken them slightly. This leads to less sunlight being reflected into space, thereby contributing to global warming. In most cities, air pollution is monitored by measuring the concentration of various pollutants at a static location using accurate, but expensive, equipment. A new trend has started with adopting off-the-shelf and portable sensors^[19] that are proven to perform similar to the stationary sensors. These air-quality monitoring systems that require long term operation without human intervention during monitoring can be powered by energy harvesters^[20]. Self-powered mobile sensing devices provide flexibility in locating and measuring pollution levels in cities.

¹⁷ Pop-Vadean, A., Pop, P.P., Latinovic, T., Barz, C. and Lung, C., 2017, May. Harvesting energy an sustainable power source, replace batteries for powering WSN and devices on the IoT. In IOP Conference Series: Materials Science and Engineering (Vol. 200, No. 1, p. 012043). IOP Publishing.

¹⁸ Cetinkaya, O., Zaghari, B., Bulot, F., Damaj, W., Jubb, S. A., Stein, S., Weddell. A., Mayfield, M., Beeby, S. Distributed Sensing with Low-cost Mobile Sensors towards a Sustainable IoT, *IEEE IoT magazine*.

¹⁹ Bulot, F.M.J., Russell, H.S., Rezaei, M., Johnson, M.S., Ossont, S.J.J., Morris, A.K.R., Basford, P.J., Easton, N.H.C., Foster, G.L., Loxham, M. and Cox, S.J., 2020. Laboratory comparison of low-cost particulate matter sensors to measure transient events of pollution. *Sensors*, 20(8), p.2219.

²⁰ Touati, F., Legena, C., Galli, A., Crescini, D., Crescini, P. and Mnaouer, A.B., 2014, December. Renewable energy-harvested sensor systems for air quality monitoring. In 2014 26th International Conference on Microelectronics (ICM) (pp. 160-163). IEEE.

A fully green approach will be developing energy harvesters made of biocompatible and biodegradable materials, assembled with environmentally friendly technologies. Using natural resources, such as renewable, lightweight, biocompatible, and biodegradable wood that behaves like piezoelectric material; can be used to replace toxic elements^[21]. Another example is triboelectric nanogenerators (TENGs) developed using micro-architected silk cocoon films, which are eco-friendly natural materials for biocompatible applications with a sustainable life-cycle analysis perspective^[22]. These micro-architected silkworm fibroin films have high surface roughness and an outstanding ability to lose electrons. However, due to small energy densities, they can only be used for low-power wearable or implantable biomedical applications.

Although the current approaches of EH do not have a zero-emission footprint yet, the current EH applications are aiming to replace toxic and non-eco-friendly energy sources with more sustainable ones. The future of EH will be nature-driven, nontoxic, biodegradable materials, which is a new paradigm toward the development of smart, green, and sustainable technologies. Economically, it will be more advantageous using bio-waste materials for a next-generation pollution-free world.

²¹ Sun, J., Guo, H., Ribera, J., Wu, C., Tu, K., Binelli, M., Panzarasa, G., Schwarze, F.W., Wang, Z.L. and Burgert, I., 2020. Sustainable and biodegradable wood sponge piezoelectric nanogenerator for sensing and energy harvesting applications. *ACS nano*, 14(11), pp.14665-14674.

²² Dudem, B., Dharmasena, R.I.G., Graham, S.A., Leem, J.W., Patnam, H., Mule, A.R., Silva, S.R.P. and Yu, J.S., 2020. Exploring the theoretical and experimental optimization of high-performance triboelectric nanogenerators using microarchitected silk cocoon films. *Nano Energy*, 74, p.104882.

5. Innovation and Future Research

Authors: Thomas Becker, Michail E. Kiziroglou, Eric M. Yeatman

Energy harvesting devices have achieved attention in the Internet-of-Things (IoT) community, at public funding bodies, as well as in various industry sectors in recent years. Many valid methodologies and technologies have been investigated and developed, leading to a substantial set of state-of-the-art devices. In Section 1 many of the underlying principles are briefly described; the technology concepts shown are at least at Technology Readiness Level (TRL) 2.

These components have been integrated in demonstrators and successfully tested in use case scenarios. Section 2 offers insight into realized demonstrators for proving the concepts and their validation in laboratories and beyond, reaching TRL 3 or even 4. These examples are representative of a range of custom energy autonomy solutions currently available at similar maturity.

The validation of energy harvesting power supplies in industrially relevant environments often fails due to insufficient matching to operational system requirements. Even though some examples of successful validation in relevant environments at prototype board or system level are reported^[160], TRL 5 or TRL 6 validation attempts typically lack sufficient advance knowledge of device performance in realistic operating scenarios, as described in Section 3.

Despite these current technology limitations, energy autonomy remains vital for wireless systems that involve more than a few nodes or remote locations. Section 4 describes key benefits in using autonomous wireless monitoring in different applications areas, taking life cycle assessments from cradle to grave into account. To leverage these benefits, further research and development efforts are necessary. A research agenda for energy autonomous microsystems will contribute to a greener IoT ecosystem by tackling the above-mentioned challenges^[161]. Energy harvesting does not consist of a single technology basis; therefore, a research strategy (and support ecosystem of stakeholders) must deal with many aspects of the various technologies and the methodologies. The research agenda discussed here focusses on developments with direct impact on innovation and availability of energy harvesting devices.

5.1. Technology Research

Beyond the state-of-the-art and roadmap of evolution for transduction materials, which have been summarized in Section 1, recent and imminent technology advances offer opportunities for overcoming some of the key missing elements identified in Section 3, at device technology level.

Increasing device functionality to more broadly occurring conditions is now a common objective among EH research efforts. Examples of proposed solutions for motion include broadband, impulse and frequency up-conversion mechanical oscillators^[162], bistable structures, and frequency up-conversion circuits. In heat harvesters, advanced heat flow designs (including dynamic thermoelectric harvesting) and the employment of heat storage units with phase change materials^[163] provide access to significant ΔT on the transducer from realistic environments. The power income from weak lighting conditions of indoor environments can be enhanced by employing semiconductors with bandgaps covering the spectrum of indoor LED sources and by employing light concentration architectures initially proposed for increasing the output power per unit mass of active material^[164]. Functionality expansion can also be achieved by combining more than one transduction mechanism into hybrid

¹⁶⁰ D. Samson, M. Kluge, T. Fuss, U. Schmid, and T. Becker, "Flight Test Results of a Thermoelectric Energy Harvester for Aircraft," *Journal of Electronic Materials*, vol. 41, no. 6, pp. 1134-1137, Jun 2012.

¹⁶¹ M. Hayes et al., "EnABLES: European Infrastructure Powering the Internet of Things," in *Smart Systems Integration; 13th International Conference and Exhibition on Integration Issues of Miniaturized Systems*, 2019, pp. 1-8.

¹⁶² J. Hao, M. E. Kiziroglou, D. C. Yates, and E. M. Yeatman, "A Motion-Powered Piezoelectric Pulse Generator for Wireless Sensing via FM Transmission," *Internet of Things Journal*, IEEE, vol. 2, no. 1, pp. 5-13, 2015.

¹⁶³ A. Elefsiniotis, D. Samson, T. Becker, and U. Schmid, "Investigation of the Performance of Thermoelectric Energy Harvesters Under Real Flight Conditions," (in English), *Journal of Electronic Materials*, vol. 42, no. 7, pp. 2301-2305, 2013/01/01 2013.

¹⁶⁴ E. C. Warmann et al., "An ultralight concentrator photovoltaic system for space solar power harvesting," *Acta Astronautica*, vol. 170, pp. 443-451, 2020/05/01/ 2020.

energy harvesters, in which more than one type of environmental energy can be harvested by single or multiple active materials^[165,166]. This can increase power density in certain conditions, but more critically, it can potentially make the autonomous power supply less dependent on the environment.

More generally, focusing power (or energy) on the transducing material is advantageous because it directly increases power density by reducing active material mass as well as by increasing efficiency. This is because efficiency often increases with the intensity of the power source. In addition, higher intensity typically leads to higher output voltage levels, which can be handled more efficiently by power management circuitry. An example is the magnetic field focusing technique employed^[167] for power line inductive energy harvesting. The light concentration technique^[164] is an application of this concept to solar harvesting. In a different case, the near-linear scaling of TEG efficiency with ΔT means that the performance of thermoelectric harvesters can be drastically enhanced by accumulating thermal energy before passing it through a TEG, so that a given amount of heat is transduced at a higher ΔT ^[168]. This is an example of accumulating energy over time. The concept of power focusing could also be considered for motion energy harvesting devices within the framework of a more general motion-translation and compliance-matching abstraction or for radio frequency and acoustic energy harvesting devices, as well as for wireless power transfer transceivers.

The combination of EH devices and wireless power transfer is also interesting, especially for use cases involving uncertain environments. An energy harvesting power receiver normally transduces environmental energy, but is also designed to receive transmitted power on occasions such as system installation, priming and testing, diagnostics and maintenance operations, or scheduled supplementary power support for more intense operating scenarios, e.g. a scheduled full-capability sampling of a wireless sensor network that usually operates in low duty cycle^[164]. Examples include a vibrational harvester that can be driven to resonance by deliberately induced vibrations to initiate or fully charge the target system; a solar harvester that is illuminated with intense lighting in necessary occasions; a thermal harvester that is artificially provided with heat; an inductive harvester excited by an inductive power transfer transmitter; or a far-field RF harvester receiving a deliberately transmitted signal. The combination of EH with wireless power transfer is expected to offer critical features, including testability, and to enhance the reliability of power autonomy for IoT, both during the early stages of industrial adoption and in the long term.

At the power management level, integrated circuit solutions are available with sub- μW quiescent power consumption, offering impedance matching, cold-starting, voltage boosting and bucking, battery and super-capacitor management and regulation, and rectification. The challenge of efficient cold-starting, especially in combination with low-voltage rectification, offers an open opportunity for enhancing the performance of state-of-the-art energy harvesting power supplies. The additional exploitation of environmental energy, such as motion as a direct switching mechanism, has shown significant potential for expanding the applicability of energy harvesting to weaker energy sources^[169]. Furthermore, actively driving the EH transducers by techniques such as piezoelectric pre-biasing^[170] and synchronized switch-on inductor^[171], has been shown to improve power density and should be considered in the development of EH power supplies. Super-capacitors are increasingly favored as buffer energy stores in harvester systems due to their high power density being desirable for sporadic

¹⁶⁵ Y. K. Tan and S. K. Panda, "Energy Harvesting From Hybrid Indoor Ambient Light and Thermal Energy Sources for Enhanced Performance of Wireless Sensor Nodes," (in English), *IEEE Transactions on Industrial Electronics*, Article vol. 58, no. 9, pp. 4424-4435, Sep 2011.

¹⁶⁶ H. Liu, H. Fu, L. Sun, C. Lee, and E. M. Yeatman, "Hybrid energy harvesting technology: From materials, structural design, system integration to applications," *Renewable and Sustainable Energy Reviews*, vol. 137, p. 110473, 2021/03/01/ 2021.

¹⁶⁷ M. E. Kiziroglou, S. W. Wright, and E. M. Yeatman, "Coil and core design for inductive energy receivers," *Sensors and Actuators A: Physical*, vol. 313, p. 112206, 2020/10/01/ 2020.

¹⁶⁸ M. E. Kiziroglou, S. W. Wright, T. T. Toh, P. D. Mitcheson, T. Becker, and E. M. Yeatman, "Design and Fabrication of Heat Storage Thermoelectric Harvesting Devices," *Industrial Electronics*, IEEE Transactions on, vol. 61, no. 1, pp. 302-309, 2014.

¹⁶⁹ G. Lombardi, M. Lallart, M. E. Kiziroglou, and E. M. Yeatman, "A piezoelectric self-powered active interface for Ac-Dc power conversion improvement of electromagnetic energy harvesting," *Smart Materials and Structures*, vol. 29, no. 11, p. 117002, 2020.

¹⁷⁰ A. D. T. Elliott and P. D. Mitcheson, "Implementation of a Single Supply Pre-biasing Circuit for Piezoelectric Energy Harvesters," *Procedia Engineering*, vol. 47, pp. 1311-1314, 2012/01/01/ 2012.

¹⁷¹ D. Guyomar, A. Badel, E. Lefeuvre, and C. Richard, "Toward energy harvesting using active materials and conversion improvement by nonlinear processing," *IEEE Transactions on Ultrasonics, Ferroelectrics, and Frequency Control*, vol. 52, no. 4, pp. 584-595, 2005.

inputs; however, their relatively high leakage currents are a barrier to wider adoption in such systems, so reducing this parameter is an important subject for further research^[172].

The advantage of energy harvesters over batteries for wireless applications increases with the time extension possibilities of maintenance events. For this advantage to be realized, harvester devices must achieve high mean-time-between-failure (MTBF) values, ideally of many years. Significant work remains to be done in this area. For example, long-term degradation of performance in piezoelectric materials (PZT) has been shown, but there is promise in designing devices that use pre-stress to keep the active material always in compression^[173].

The advantage of EH over batteries will be absolute in cases where the operating environment prevents the use of electrolytic components due to excess temperatures. Therefore, development of harvesting solutions fully compatible with such extreme environments is an attractive topic for future work. Since batteries will also be excluded as buffer storage in such cases, alternatives are likely to be needed, for example, mechanical energy storage.

As discussed, energy harvesters tend to require specific designs for each application scenario. The lack of devices of greater universality, particularly compared to batteries and other components, such as radio interfaces, limits the ability to manufacture energy harvesters in high volume at low cost. This lack of universality can be tackled in various ways. One possibility is to increase the use of modularization. For example, vibration harvesters could combine a use-specific motion adaptation module with a standard mechanical-to-electrical transduction module. Standard thermoelectric modules could be combined with low-cost thermal conductors for geometric transformation to adapt to source characteristics to maximize efficiency. Such modular approaches should be closely tied to standardization and inter-operability efforts, as discussed below.

5.2. *Development and Sustainability*

As described above, enabling and supporting technologies are required and should be investigated further to increase the efficiency of the key components of the harvesting devices. Obviously, not all can be mentioned in this white paper: storage technologies might be unavoidable for the time being, specific materials might be required for medical applications, and many others. Moreover, special devices, such as the micro fuel cell by Fuelium (*see Section 0*), are not discussed in detail.

In an integrated system approach, energy harvesting lies at the interface between a wireless system and the environment. It can be considered as part of an interactive package, along with sensing, actuation, communication, mechanical support, and protection. As such, energy harvesting devices can be developed at system integration level, offering several opportunities. These include (1) joint sensing and harvesting from a common transducer, (2) combined harvesting and harsh-environment protection, e.g. by mechanical shock-damping, smoothing temperature transients^[174], radiation, and field shielding^[175], (3) joined power and data reception^[176], and (4) a complimentary multi-dimensional design space in which energy harvesting can support the power autonomy of portable systems. Such functional integration would be particularly valuable for applications with stricter size or weight constraints.

The availability of modular building blocks currently drives the use case development described in Section 2. As pointed out in Section 3, system integrators do not want too many feedback loops in the development steps for low level components. Therefore, system design software, such as web-based harvester generators, could provide a key medium for communicating principles and size, weight, and

¹⁷² G. V. Merrett and A. S. Weddell, "Supercapacitor leakage in energy-harvesting sensor nodes: Fact or fiction?," in 2012 Ninth International Conference on Networked Sensing (INSS), 2012, pp. 1-5

¹⁷³ P. Pillatsch, B. L. Xiao, N. Shashoua, H. M. Gramling, E. M. Yeatman, and P. K. Wright, "Degradation of bimorph piezoelectric bending beams in energy harvesting applications," *Smart Materials and Structures*, vol. 26, no. 3, p. 035046, 2017/02/14 2017.

¹⁷⁴ M. E. Kiziroglou and E. M. Yeatman, "Protection of Electronics from Environmental Temperature Spikes by Phase Change Materials," (in English), *Journal of Electronic Materials*, vol. 44, no. 11, pp. 4589-4594, 2015/11/01 2015.

¹⁷⁵ M. E. Kiziroglou, S. W. Wright, and E. M. Yeatman, "Coil and core design for inductive energy receivers," *Sensors and Actuators A: Physical*, vol. 313, p. 112206, 2020/10/01/ 2020.

¹⁷⁶ M. E. Kiziroglou, D. E. Boyle, S. W. Wright, and E. M. Yeatman, "Acoustic power delivery to pipeline monitoring wireless sensors," *Ultrasonics*, vol. 77, pp. 54-60, 2017.

performance attributes of EH to the end users in a comprehensive manner, as well as during early stages of development. Such software may help foster the acceptance of harvesting devices by industrial users. Software can also provide a key role in predicting and optimizing system-level performance of parts and predicting overall battery life in advance of deployments. This can guide developers of parts at early stages towards such optimization. Furthermore, it can provide a key link for stakeholders in the power IoT ecosystem to collaborate.

Furthermore, recyclability and compliance with current and future legislations towards the green initiatives and related international sustainable development goals is of utmost importance to industrial applications. In this perspective, energy autonomy is a key requirement for using IoT technology to achieve the reliability and sustainability objectives of the global environmental roadmap. This includes private and public industrial, network and civil infrastructure assets (including communication) as well as data acquisition, analysis, and exploitation infrastructure.

5.3. Industry and Innovation

Beyond device- and system-level research and development, innovation towards easy-to-install devices and the fast transfer into industrial products is required and might need additional support because start-ups or small and medium enterprises are often the technology drivers. This is also true for obsolescence management in fast growing and changing technology areas. Making commercial off-the-shelf (COTS) devices available for a broad range of power and energy requirements is a first step and many companies are working on that. However, as customized components and fabrication methods are often required in the production of energy harvesting devices, supply chains have to be supported by public bodies and industry to help small companies enter the market in a sustainable way. Initiatives, such as the PSMA biennial workshop EnerHarv^[177] and the EU EnABLES project^[178], endeavor to create such an ecosystem of stakeholders, create awareness and foster synergies, guide technology roadmaps, and provide methodologies for accelerating the development of standardized, inter-operable and system-optimized power IoT solutions.

Standardization is another step towards market acceptance. Energy harvesting is currently constrained between wireless communications standards and measurement rules for the dedicated monitoring task. A more determined step towards standardization is strongly recommended to support, shape, coordinate, and guide research efforts at the component and device level, prioritizing restrictions, and accounting for foreseeable future challenges. Furthermore, standardization in technology adoption and deployment procedures is expected to accelerate wider commercial adoption of energy harvesting. Early contribution of the energy harvesting community in defining future network standards, such as 6G and beyond, is required to avoid integration hurdles and to support a green IoT future.

There are many opportunities in using energy harvesting beyond the inherent self-powering aspect. The vision of IoT deployment, high-speed wireless networking, and potential applications is currently obscured by powering limitations and addressing them may open unforeseen opportunities in fields like pervasive sensing, computing, intelligence, and autonomous virtual sensing. As energy harvesting is reaching a technology mutation point, its combination with wireless power transfer, fast and low-power communication and computation, and smart multi-functional interfacing and integration will provide true wireless, maintenance-free, and green IoT nodes. Standardization could bridge the yet-unshaped new capabilities offered by energy harvesting to the requirements of industrial users, avoid compatibility and divergence issues, and provide a harmonized research and investment framework for forecastable, sustainable growth. Turning the power autonomy technology from a collection of niche opportunities and singular inventions to a reliable research and development platform would offer benefits analogous to those of Moore's-law in microelectronics.

¹⁷⁷ <http://www.enerharv.com>.

¹⁷⁸ <https://www.enables-project.eu/outputs/position-paper/>.

Acronyms

Ac	Alternating Current
AEH	Acoustic Energy Harvester
AMES	Autonomous Micro Energy Source
ASIC	Application Specific Integrated Circuit
BFC	Biofuel Cell
BLE	Bluetooth Low Energy
BS	Base Station
CAGR	Compound Annual Growth Rate
CBA	Cost-Benefit Analysis
COTS	Commercial Off-the-Shelf
ECG	Electrocardiogram
EGOFET	Electrolyte-Gated Field-Effect Transistor
EH	Energy Harvesting
EHT	Energy Harvesting Technologies
EIRP	Effective Isotropic Radiated Power
ELDC	Electric Double-Layer Capacitor
EMHR	Electromechanical Helmholtz Resonator
EnSO	Energy for Smart Objects
ESR	Effective Series Resistance
EVEH	Electromagnetic Vibration Energy Harvesters
FIV	Flow-Induced Vibration
FSM	Finite State Machine
GNSS	Global Navigation Satellite Systems
HP	High Power
HWTR	Half-Wave Tube Resonators
IC	Integrated Circuit
IIoT	Industrial Internet of Things
IoT	Internet of Things
LCA	Life Cycle Assessment
LDOs	Low-Drop-Out Regulators
LP	Low Power
LPWAN	Low-Power Wide Area Networks
MCU	Microcontroller Unit
MEMS	Micro-Electro-Mechanical System
Mioty®	My Internet of Things
MMRTG	Multi-Mission Radioisotope Thermoelectric Generator

MOP	Means of Protection
MPP	Maximum Power Point
MPPT	Maximum Power Point Tracking
MTBF	Mean Time Between Failures
MWTs	Miniature Wind Turbines
NFC	Near Field Communication
NVM	Non-Volatile Memory
PAC	Physical Access Control
PCB	Printed Circuit Board
PCE	Power Conversion Efficiency
PMUs	Power Management Units
PMUT	Piezoelectric Micromachined Ultrasonic Transducers
POC	Point of Care
PPG	Photoplethysmogram
PSMA	Power Sources Manufacturers Association
PV	Photovoltaic
PV-Cell	Photovoltaic Cell
PZT	Lead Zirconate Titanate
PZT	Piezoelectric Materials
QoS	Quality of Service
QWTR	Quarter-Wave Tube Resonators
REEACH	Range Extenders for Electric Aviation with Low Carbon and High Efficiency
RF	Radio Frequency
RoHS	Restriction of Hazardous Substances
SIL	Safety Integrity Level
SoC	System on Chip
SPL	Sound Pressure Level
TCS	Thermoelectric Conversion Systems
TDOA	Time Difference of Arrival
TEG	Thermoelectric Generator
TENGs	Triboelectric Nanogenerators
TOF	Time of Flight
TRL	Technology Readiness Level
UWB	Ultra-Wide Band
VAV	Variable Air Volume
WPT	Wireless Power Transfer
WSN	Wireless Sensor Network
WSNs	Wireless Sensor Nodes