

Title	Robust packaging of photonic RF modules using ultrathin adaptive optical interconnect devices
Authors	Riza, Nabeel A.;Yuan, ShiFu
Publication date	1997-10-23
Original Citation	Riza, N. A. and Yuan, S. (1997) 'Robust packaging of Photonic RF Modules using Ultra-Thin Adaptive Optical Interconnect Devices', Proceedings of SPIE, 3160, Optical Technology for Microwave Applications VIII, Optical Science, Engineering and Instrumentation '97 San Diego, CA. USA. doi: 10.1117/12.283941
Type of publication	Conference item
Link to publisher's version	10.1117/12.283941
Rights	© 1997 Society of Photo-Optical Instrumentation Engineers (SPIE). One print or electronic copy may be made for personal use only. Systematic reproduction and distribution, duplication of any material in this paper for a fee or for commercial purposes, or modification of the content of the paper are prohibited.
Download date	2024-05-21 12:57:16
Item downloaded from	https://hdl.handle.net/10468/10181

PROCEEDINGS OF SPIE

[SPIDigitalLibrary.org/conference-proceedings-of-spie](https://spiedigitallibrary.org/conference-proceedings-of-spie)

Robust packaging of photonic rf modules using ultrathin adaptive optical interconnect devices

Riza, Nabeel, Yuan, ShiFu

Nabeel A. Riza, ShiFu Yuan, "Robust packaging of photonic rf modules using ultrathin adaptive optical interconnect devices," Proc. SPIE 3160, Optical Technology for Microwave Applications VIII, (23 October 1997); doi: 10.1117/12.283941

SPIE.

Event: Optical Science, Engineering and Instrumentation '97, 1997, San Diego, CA, United States

Robust packaging of photonic RF modules using ultra-thin adaptive optical interconnect devices

Nabeel A. Riza* and Shifu Yuan

Center for Research & Education in Optics and Lasers (CREOL)
and the Department of Electrical and Computer Engineering
University of Central Florida
4000 Central Florida Blvd., Orlando, FL 32816-2700

ABSTRACT

Ultra-thin, electrically programmable, low control power optical devices are proposed as adaptive optical alignment correction devices for future deployable photonic modules for RF signal processing applications. A substantial relative optical/RF gain (i.e., 7.92 dB RF gain) in a free-space PDL that requires a fiber remoted feed in the infrared 1300 nm optical spectrum has been successfully demonstrated.

Keyword: Adaptive Optical Interconnect, Packaging, Photonic RF Module, Phased Array Antenna, Liquid Crystal Devices

1. INTRODUCTION

Photonic technology is beginning to show high promise for various commercial and defense scenarios such as photonically controlled RF systems and analog fiber-optic communication links. An important issue with the insertion of any photonic module technology for practical applications is the robustness of the photonic module packaging when subjected to harsh vibration and other environmental conditions, such as in a defense scenario or low maintenance commercial product. Hence, it is critical that certain adaptive and programmable photonic module packaging technology be developed for insertion into future deployable photonic modules.

We propose the use of our novel ultra-thin, high optical efficiency, electrically programmable, low control power optical devices as adaptive optical alignment correction devices in future practical photonic modules. Our devices are flexible, and can work with all base module design technologies, including optical fiber, integrated optical waveguide, free-space, or solid-optics designs.^[1] The devices will rely on refractive and diffractive optical designs using thin film materials such as various types of liquid crystals (LCs). For eventual ease in large scale fabrication and cost reduction, we propose the use of large area substrates that have both the device control electrode structure plus the smart and low power consumption control electronics. Both planar single devices for point-to-point optical beam corrections and pixelated device arrays for parallel optical interconnections will be developed and tested in typical photonic control modules for RF system. Details of our approach are further described in this paper.

The outcome of our research effort will be low cost adaptive optic packaging devices for large scale use and insertion into photonic modules. These low cost and technology flexible devices will not only hasten the use of photonic modules used in military RF systems by making the modules more practical and reliable, they will also give a boost to the practical deployment of many commercial photonic module applications such as parallel and distributed high speed optically interconnected digital electronic processors, distributed optical sensors for aeroplane and electric power system applications, and optical probes for biomedical applications.

2. FIBER-OPTICALLY INTERCONNECTED N-BIT PHOTONIC DELAY LINE

The objective is to realize a deployable N-bit photonic delay line. One robust solution is to form fiber-optically interconnected photonic single bit modules (see Fig.1). This is because today's commercial fiber-optic cables and connectors form excellent optical interconnection hardware, giving both environmentally robust and well engineered control modules. Features of this fiber-optically

* N. A. Riza: Email: riza@creol.ucf.edu; Telephone: 407 823-6829; Fax: 407 823-3354

interconnected PDL approach include (a) ease in assembly of N-bits, (b) ease in maintenance and repair, and (c) compact size via fiber delay paths.

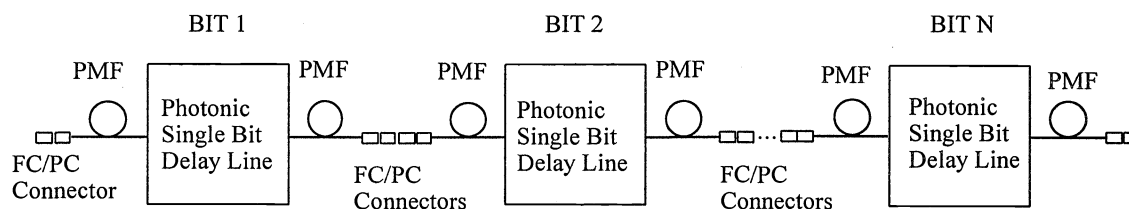

Fig.1 Schematic diagram of N-bit photonic delay line (PMF: Polarization Maintaining Fiber).

Fig.2 shows the scenario of a typical transmissive single bit non-fiber delay design for moderate to short delays. For a typical design example, the delay path gr-in-to-gr-in distance is 20 cm, while the straight path GRIN-to-GRIN distance is 5 cm. There are four concerns relating to this type of PDL that uses a combination of fiber, free-space and solid-optics. They are (a) efficiently getting light back into the output fiber-optics, (b) providing a mechanism for alignment correction or robust packaging for mechanically tolerant system, (c) providing flexibility in range of time delays possible with no hardware change, and (d) providing high precision optical path compensation and design for both the delay and no-delay paths. Note that the use of bulk and fixed imaging optics, as previously used in our PDLs, does not solve all these concerns.

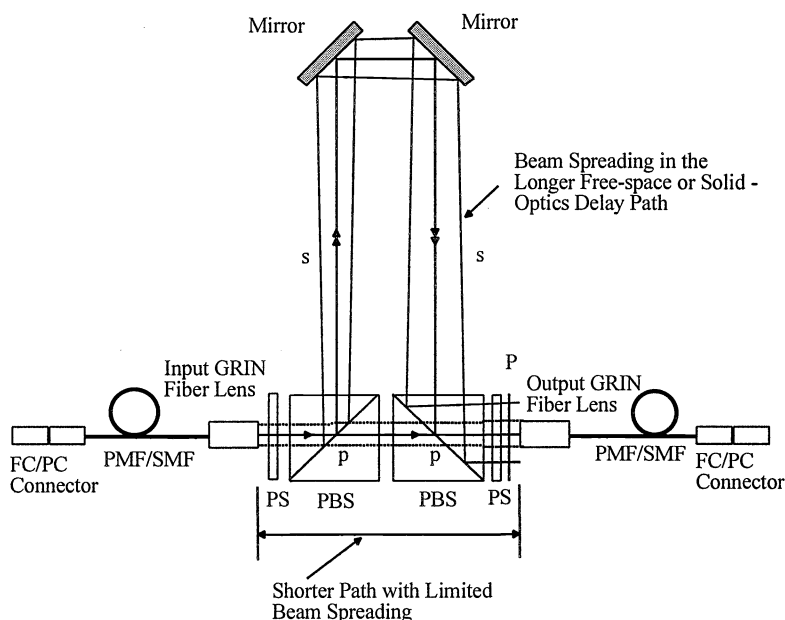

Fig.2 shows a typical example of a transmissive single bit non-fiber delay design for moderate to short delays. One can observe the beam spreading in the longer free-space or solid -optics delay path with the shorter path with limited beam spreading. (PS: Polarization Switch)

The solution for these concerns involves the use of two polarization sensitive adaptive electrically programmable optical wavefront correctors, e.g., birefringent-mode nematic liquid crystal (BM-NLC) devices, ^[1] as shown in Fig. 3.

Another similar scenario is the reflective single bit non-fiber design for moderately long delays (see Fig.4). In this case, for a typical design example, the delay path GRIN-to-GRIN distance is 45 cm, while the straight path GRIN-to-GRIN distance is 5 cm again, the robust packaging solution is by using two polarization sensitive adaptive electrically programmable optical wave front correctors, e.g., BM-NLC devices (see Fig.5).

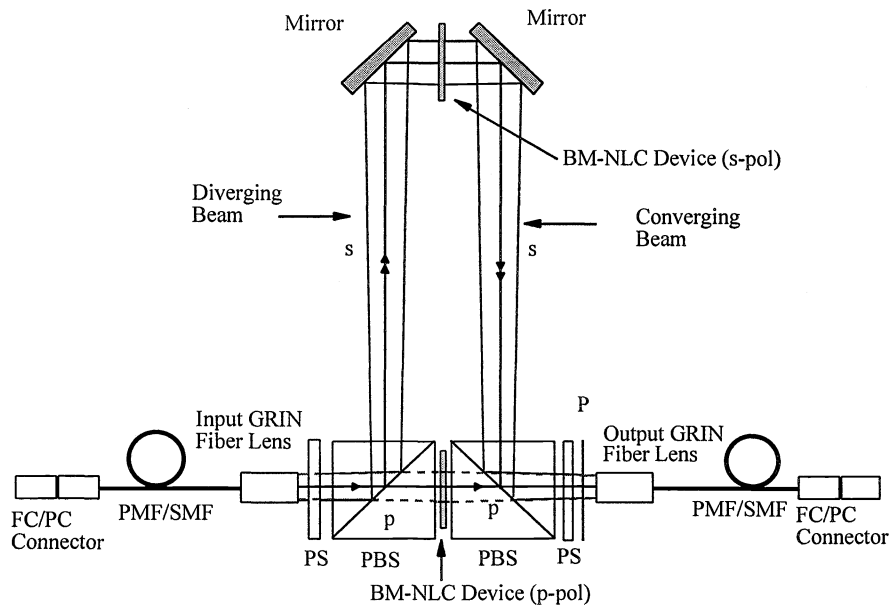

Fig.3 schematic of optical wavefront correction using two polarization sensitive adaptive electrically programmable BM-NLC devices.

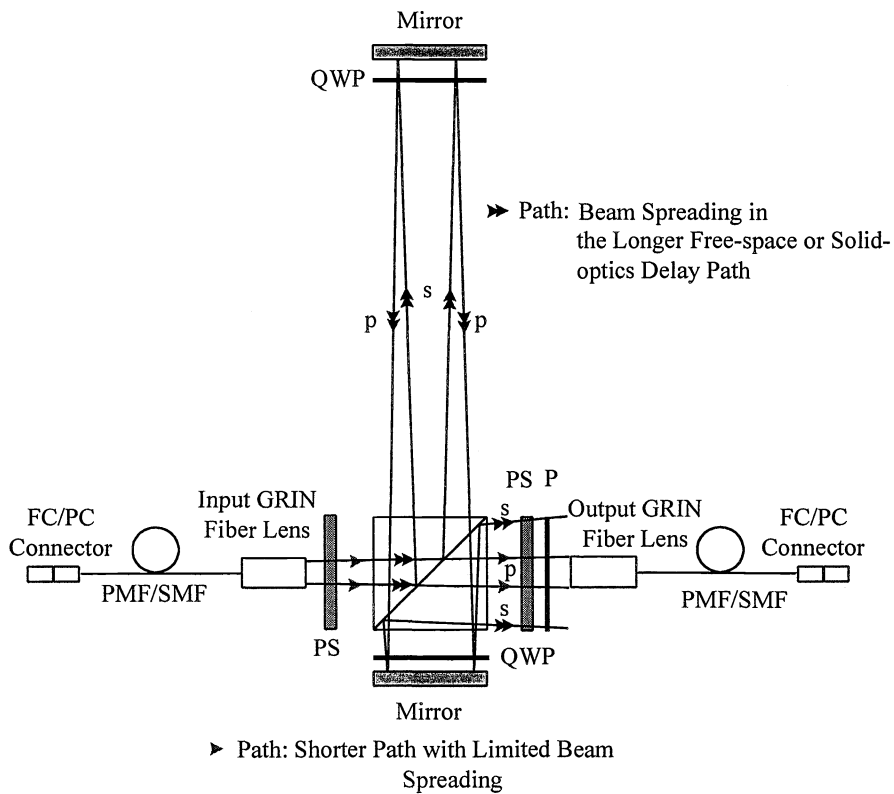

Fig.4 A typical example of reflective single bit non-fiber design for moderately long delays (QWP: quarter wave plate).

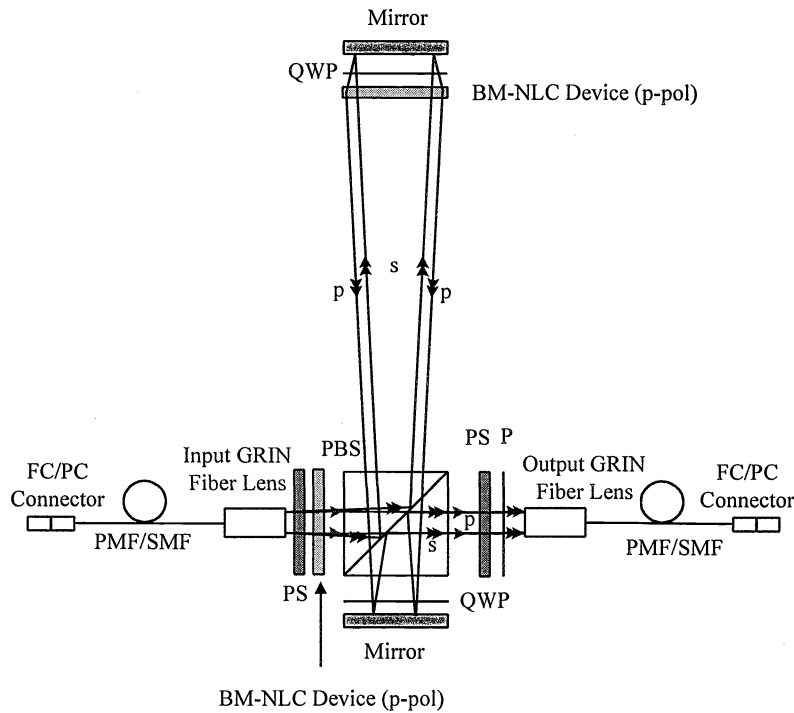

Fig.5 A reflective single bit non-fiber design schematic of optical wavefront correction using two polarization sensitive adaptive electrically programmable BM-NLC devices.

3. EXPERIMENTAL DEMONSTRATION OF ADAPTIVE OPTICAL INTERCONNECTS FOR THE REFLECTIVE PDL

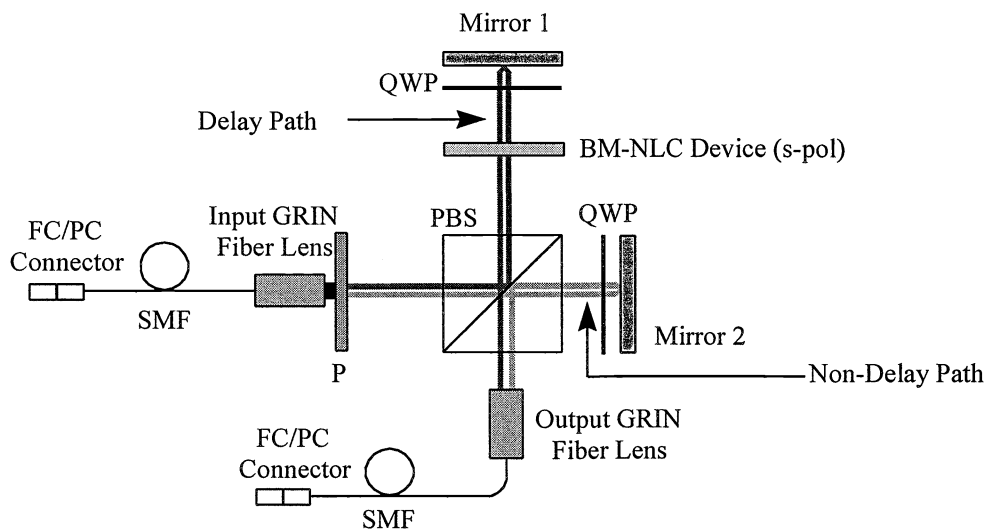

Fig.6 shows the experimental setup of the fiber-optically fed and detected, reflective PDL used for measuring optical gain via the use of an electrically programmable adaptive wavefront correction device. P, Polarizer; QWP, Quarter Wave Plate; s-pol, Vertical Polarization Direction.

The experimental layout is shown in Fig.6. The length of the longer delay path is 18 cm, and we choose to use this longer path to demonstrate optical gain for our analog fiber-link coupled PDL. The BM-NLC device used as the adaptive wavefront corrector has 1500 pixels, with a thin film transistor (TFT) per pixel. The device layout is shown in Fig.7.

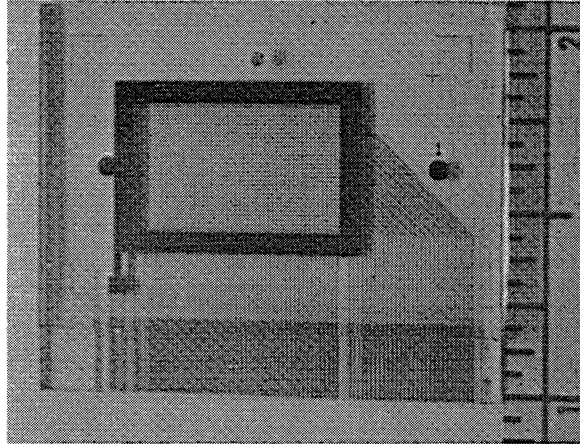
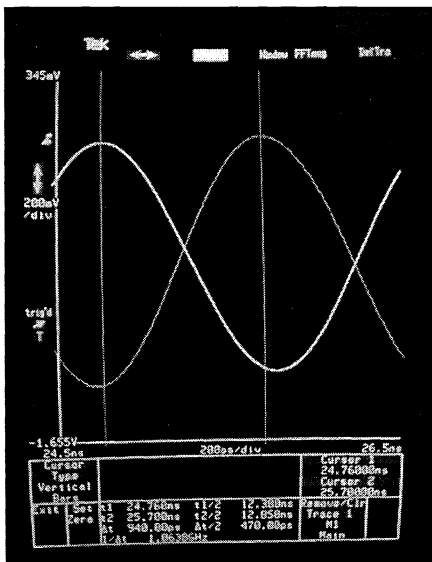
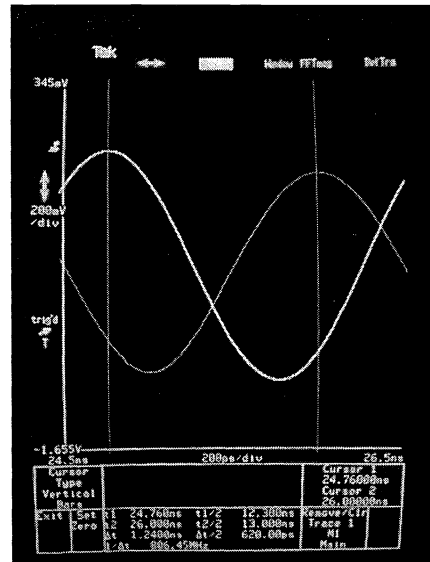

Fig.7 The experimental BM-NLC device layout. (Scale in inches)

First, the experimental PDL is tested to observe the time delay operation. The difference between the delay and no-delay paths is 9 cm which corresponds to a 0.3 ns relative time delay. Fig.8 shows this relative time delay observed for a 500 Mhz analog modulation frequency for our semiconductor laser-based Lasertron fiber-optic link. Hence, our experimental PDL works according to design. The lower 500 Mhz frequency is used to correspond with our oscilloscope measurement capabilities.



(a) Time delay of straight path signal to reference is 0.94 ns



(b) Time delay of delay path signal to reference is 1.24 ns

Fig.8 shows the 0.3 ns relative time delay observed from our PDL at a 500 Mhz analog modulation frequency used for our 1300 nm semiconductor laser-based directly modulated fiber-optic link.

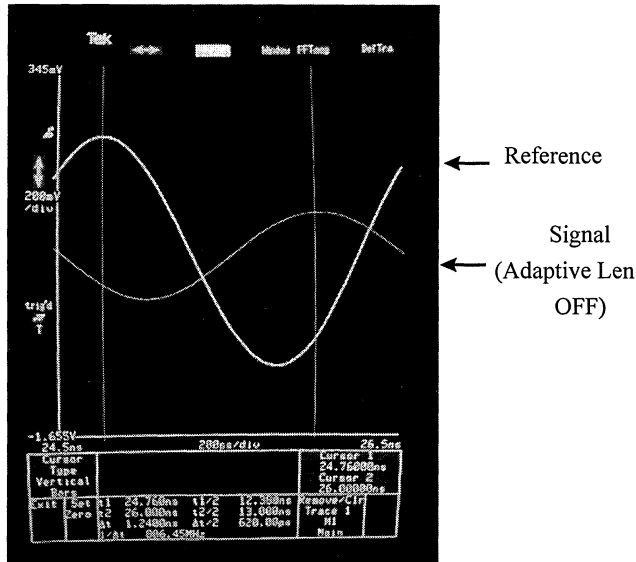

(a) Optical power of the signal is $70 \mu\text{W}$

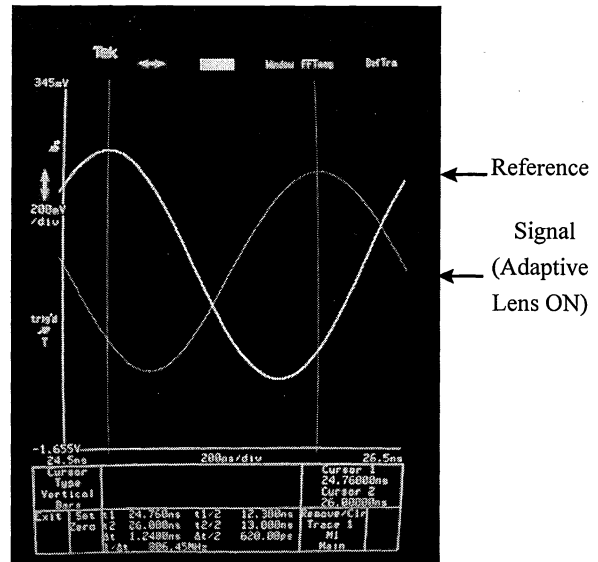

(b) Optical power of the signal is $163.7 \mu\text{W}$

Fig.9 shows a 500 Mhz signal trace, indicating a more than doubling of optical power from 70 to $163.7 \mu\text{W}$ using the PDL with an adaptive optical interconnect.

Next we observe the optical gain of our PDL using our adaptive optical interconnect implemented with the BM-NLC device. Fig.9 shows a 500 Mhz signal trace, indicating a more than doubling of optical power from 70 to $163.7 \mu\text{W}$. Since, our PDL is designed to operate over very wide RF bandwidths, Fig.10 shows the optical gain operation at 12 Ghz, where we measure a 3.96 dB optical gain or a 7.92 dB RF gain. This is shown by the RF spectrum analyzer traces in Fig.10.

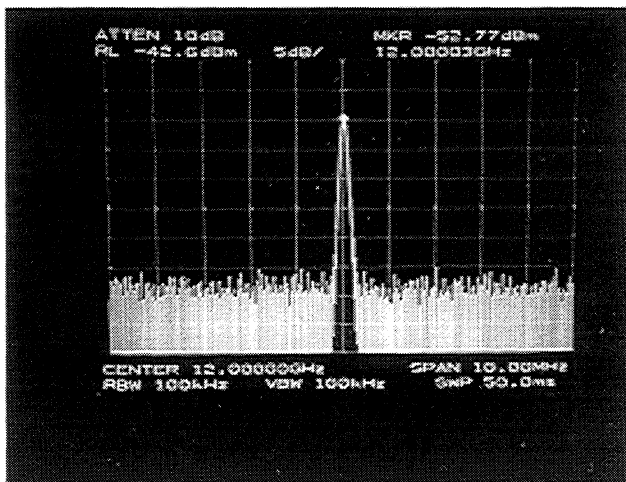

(a) BM-NLC device is off

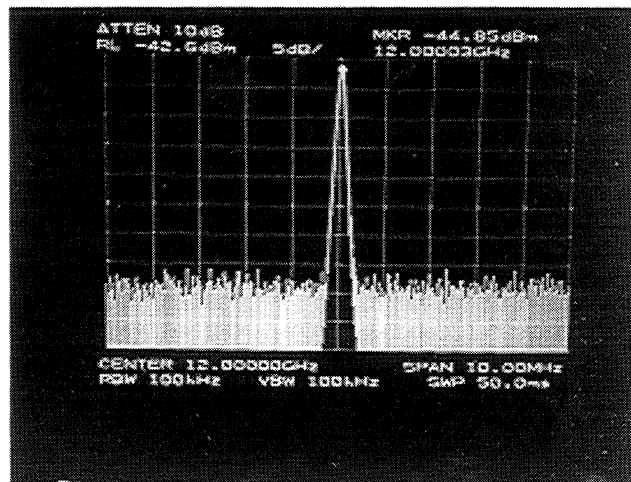

(b) BM-NLC device is on

Fig.10 shows RF spectrum analyzer traces at 12 Ghz, indicating an RF gain of 7.92 dB using the adaptive optical interconnect in the PDL.

4. ADAPTIVE OPTICAL INTERCONNECT DESIGN FOR THE FREE-SPACE FIBER REMOTED PDL

The purpose of the adaptive wavefront connection device is two fold. One, the adaptive device, when possible, should compensate for free-space path optical beam spreading losses. Two, the adaptive device must act as a beam alignment tweaker to correct for minor beam misalignments that can cause major optical losses due to the sensitivity of the single mode fiber output coupling optics typically required in most PDLs for antenna applications. Because we are using thin-film BM-NLC devices with mostly low (e.g., $\Delta n=0.2$) birefringence values, only thin lenses or low power wavefront correctors can be implemented electronically. Thus, there is a limit

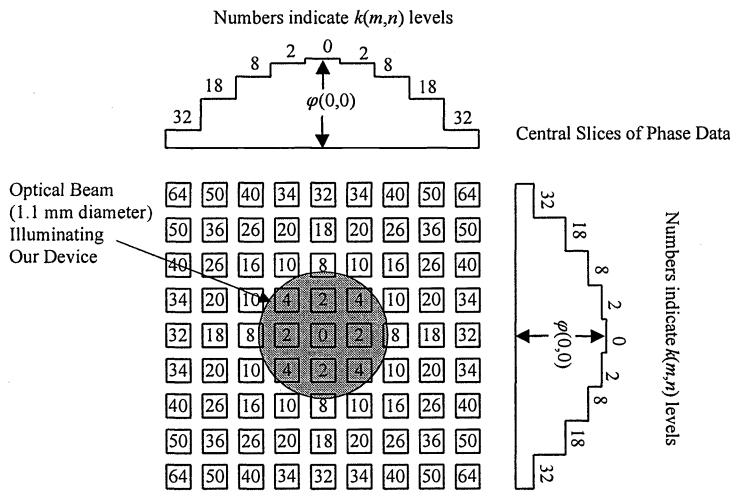

beyond which the BM-NLC device cannot correct for beam spreading, and a combination of fixed refractive/diffractive optics and thin-film electronically/optically programmable adaptive optics must be used in the PDL. Our maximum GRIN-to-GRIN distance is 18 cm for our experimental PDL. Knowing the limits of our BM-NLC device, we place our BM-NLC device between mirror1 and the PBS, with the BM-NLC device alignment with its nematic director along the vertical or s-polarization direction. The mirror1 to BM-NLC device distance is 3 cm and mirror1 to output GRIN distance is 8.5 cm. This makes a total free-space path of 11.5 cm where the adaptive BM-NLC device forces the light be to converge so as to efficiently couple into the output GRIN lens.

Fig.11 The 1.1 mm diameter 1300 nm infrared beam location that strikes our BM-NLC device, with the phase data profile scanned along the x and y directions.

Fig.11 shows the 1.1 mm diameter 1300 nm infrared beam that strikes our BM-NLC device. Note that only 9 pixels are optically

exposed, implying that the adaptive wavefront device has 9 degrees of freedom. This figure also shows the phase data profile for our optimum converging lens. To form a thin-lens, the phase shift of our (m,n) -th pixel is given by:

$$\varphi(m,n) = \varphi(0,0) - 0.7154\pi \cdot \frac{k(m,n)}{98}, \quad (1)$$

where $k(m,n)=0$ to 98 and $k(0,0)=0$. Fig.12 shows the 2-D programmed gray-scale phase data of our optimum BM-NLC adaptive lens. We estimate the converging focal length of this adaptive lens to be 5.23 m, indicating that a low power lens is indeed adequate for our designed PDL.

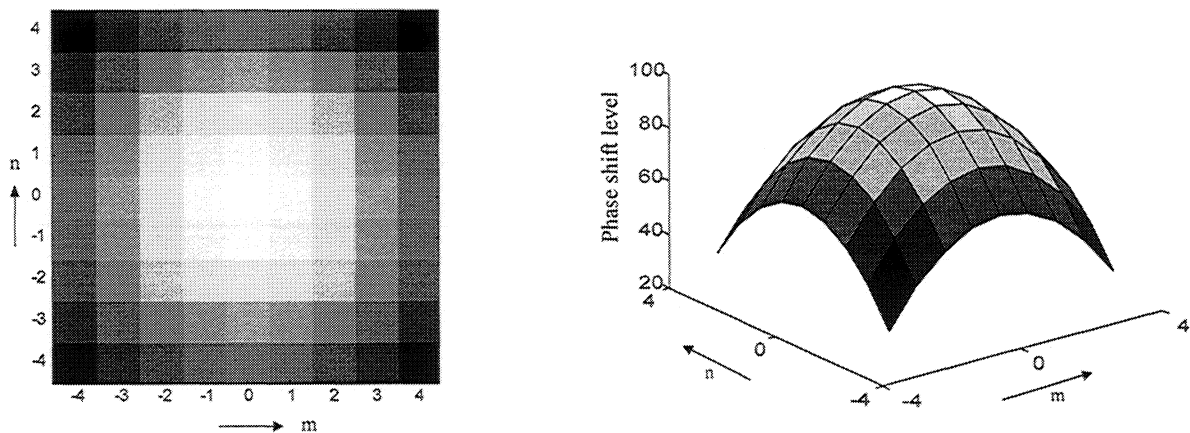

Fig.12 shows the 2-D programmed phase data of our optimum BM-NLC adaptive lens.

5. CONCLUSION

The BM-NLC device used in our experiment was not optimized for this PDL adaptive interconnect application. First, the device was not designed for the 1300 nm infrared wavelength, and had no AR coatings at 1300 nm. Second, the pixel size and pitch of around 300 μm is rather large, and this limits the useful space bandwidth product (SBP) of the optically active adaptive wavefront corrector. Hence, immediate improvements in these two areas of BM-NLC device design can provide further improvements in optical/RF signal gain via adaptive optics. In addition, with a higher device SBP, more optical beam alignment fine tweeking can be implemented to provide robust packaging for these PDL modules. Because both the tweeking and beam spreading compensation operation are not required at fast switching rates, the millisecond regime response of BM-NLC devices fits the problem at hand quite adequately. In addition, the low cost of NLC technology is an attractive feature for implementing this adaptive optics robust packaging tool for these RF/Optoelectronic control modules.

In conclusion, we have successfully demonstrated substantial relative optical/RF gain (i.e., 7.92 dB RF gain) in a free-space PDL for RF applications where the PDL requires a fiber remoted feed in the infrared 1300 nm optical spectrum. The need for both fiber and free-space optics in the PDL structure warrants an adaptive optics solution, both from a robust packaging and beam spreading compensation point-of-view. A trade-off exists between adaptive device loss mechanisms such as pixel grid structure diffraction effects and the adaptive device gain mechanisms such as device electrically controlled birefringence values and total optically active area pixel count. Optimized design engineering of both the adaptive wavefront corrector device and the fiber-optically remoted free-space PDL is required to correctly match the PDL needs via the available adaptive device parameters.

ACKNOWLEDGEMENT

This work is supported by the Office of Naval Research, grant #N000149510988, Program Monitor Dr. W. Miceli. We would like to thank graduate student N. Madamopoulos for useful discussions.

REFERENCES

1. N. A. Riza, "Advances in Three Dimensional Reversible Photonic Modules for Phased Array Control," Proc. SPIE., Vol. 2844, pp. 274-283, Denver, August 1996.