

Title	Artificial neural network application in short-term prediction in an oscillating water column
Authors	Sheng, Wanan; Lewis, Anthony
Publication date	2010-01
Original Citation	Sheng, W. and Lewis, A. (2010) ' Artificial neural network application in short-term prediction in an oscillating water column', Proceedings of the 20th International Offshore and Polar Engineering Conference, ISOPE 2010, Beijing; China, 20-25 June. Vol. 1, pp. 774-781.
Type of publication	Conference item
Link to publisher's version	http://www.isopec.org/publications/proceedings/ISOPE/ISOPE%202010/start.htm
Rights	© 2010 by The International Society of Offshore and Polar Engineers (ISOPE).
Download date	2025-01-25 23:44:12
Item downloaded from	https://hdl.handle.net/10468/2891



UCC

University College Cork, Ireland
Coláiste na hOllscoile Corcaigh

Artificial Neural Network Application in Short-Term Prediction in an Oscillating Water Column

Wanan Sheng, Tony Lewis

Hydraulics and Maritime Research Centre, University College Cork, Ireland

ABSTRACT

Oscillating Water Column (OWC) is one type of promising wave energy devices due to its obvious advantage over many other wave energy converters: no moving component in sea water. Two types of OWCs (bottom-fixed and floating) have been widely investigated, and the bottom-fixed OWCs have been very successful in several practical applications. Recently, the proposal of massive wave energy production and the availability of wave energy have pushed OWC applications from near-shore to deeper water regions where floating OWCs are a better choice.

For an OWC under sea waves, the air flow driving air turbine to generate electricity is a random process. In such a working condition, single design/operation point is nonexistent. To improve energy extraction and to optimise the performance of the device, a system capable of controlling the air turbine rotation speed is desirable. To achieve that, this paper presents a short-term prediction of the random process by an artificial neural network (ANN), which can provide near-future information for the control system. In this research, ANN is explored and tuned for a better prediction of the airflow (as well as the device motions for a wide application). It is found that, by carefully constructing ANN platform and optimizing the relevant parameters, ANN is capable of predicting the random process a few steps ahead of the real time with a good accuracy. More importantly, the tuned ANN works for a large range of different types of random process.

KEY WORDS

Artificial Neural Network; Short-Term Prediction; Oscillating Water Column; Wave Energy Converter; Power Take-off and Control.

NOMENCLATURE

E	error
f	activation function
x_i	input data ($i=1, 2, \dots, n$)
t_i	target data ($j=1, 2, \dots, p$)
it	iteration number
eps	residual
cfn	confinement of input data
α	training rate
H_j	outputs from the hidden layer
O_j	outputs from the output layer
R	correlation coefficient

RRE	root relative error
W_{ij}	weights for the hidden layer
θ_j	biases for the hidden layer
ANN	Artificial Neural Network

SUPERSCRIPTS/SUBSCRIPTS

new	modified values
old	old values
i	indicate the numbering of the input layer
j	indicate the numbering of the hidden/output layer
n	time step

INTRODUCTION

Oscillating water column (OWC) is one popular type among the wave energy converters due to its simplicity and non-moving component in sea water (the only moving component is the air turbine for power take-off), and has been widely investigated either bottom-fixed or floating devices. Both types of OWCs work in a same principle where the reciprocating flow of air due to the inside oscillating surface of water drives an air turbine (mounted on the top of the structure) to generate electricity. The bottom-fixed OWCs have been very successful so far, but they are only applicable in a few sites where the water depth is shallow, and where wave energy is well concentrated. For massive energy production and availability of wave energy, the OWC devices need moving from seaside or near-shore to open and deeper water regions, and the devices are hence evolved to floating structures. Obviously, the floating types have many more difficulties, such as working in more severe wave/tide/current conditions, mooring design and device survivability etc. In addition, some other engineering and economic issues must be addressed before any massive commercial wave energy production. A good example is the Irish Protocol Development Phases, in which 5 step-by-step phases in the Ocean Energy Development process have been proposed (Lewis 2009). The very first phase starts with a small scale model (1:50~1:100); and progresses to the second phase when a larger scaled model (1:15~1:25) is used. The first two phases with relatively small models can be studied physically in laboratory as well as numerically, addressing the device functionality and early-stage optimisation. The third phase is a sea test with a scaled model (~1:4), followed by a larger model (~1:1.25) in Phase 4. In these two phases, a complete device, including control system, power take-off system, mooring system, and grid connection etc. has been assembled. In this scaled level, some

engineering issues and economics assessment can be well addressed. The final phase is the full scale pre-commercial device after all major problems have been resolved during the wave energy development. It should be noted that in the development process, both experimental and numerical methods are both important in every stage. From these careful evolutions, it can be understood how difficult it is for ocean energy device development.

At HMRC, extensive research has been undertaken into floating OWCs, including the backward bent duct device (i.e., B2D2 or OE Buoy), and several simplified OWCs, to explore the hydrodynamics and aerodynamics. The hydrodynamic behavior of OWCs is very complicated, and the problem becomes more difficult when the hydrodynamics of the device is coupled with the aerodynamics of the air flow in the column, and the air passage through an air turbine.

To improve the device performance, so to increase the power extraction, either an optimized design of the device or a controllable operation is desirable. The former is hard to achieve due to lack of reliable prediction tools. The latter may be relatively easier to achieve from the standpoints of feasibility and practicality. The short-term prediction of the airflow employed in this paper is that based on the real-time airflow information (time series), an artificial neural network is applied to predict the airflow several steps ahead of the real time. The ahead-real-time prediction of airflow information can then be provided to the control system, which alters the air turbine rotation speed, hence to get better performance of the air turbine during the reciprocating cycle. More importantly, it is a good way to avoid turbine stalling when the airflow becomes too large. In this way, the complicated hydrodynamic and aerodynamic problems have been overcome somewhat from the standpoints of operations. A better energy extraction may be achieved for a given OWC.

It is well known that artificial neural networks (ANNs) are very capable of predicting the near future behaviour, and hence have been widely used for short-term prediction in many areas. General studies of ANNs can be seen in Rajos (1996) and Adya (1998), and the basic guidelines and practice have also been given by Zhang et al. 1998, Felix et al. 2002, Akzhalova et al. 2007 and Yao et al. 2009. Practical applications include stock forecasting (Chapman 1994, and Moody 1995), traffic forecasting (Dia, 2001), river and harbour level prediction (Teschl et al. 2006 and Lee 2008), data assimilation (Furtado et al. 2008) and data processing (Elsner 1992), wave forecasting (Deo et al 1999 & 2001, Makarynsky 2004, Mandal et al. 2006, Price et al 2007, Fusco et al. 2009, and Tsai et al 2009), and signal monitoring (Keyvan et al 1997). More relevantly to this research, ANNs have also been used to predict the motions of floating structures (Haddara et al 1999), sea profile prediction for wave energy application (Fusco et al 2009), and its utilisation to the Archimedes Wave Swing (the well-known AWS) control (Beirao et al. 2007).

ARTIFICIAL NEURAL NETWORKS

Artificial neural networks normally consist of at least three layers: one input layer, one or more hidden layers, and one output layer. Practically, an ANN never needs more than two hidden layers, but one hidden layer may be enough for most forecasting applications (Zhang et al 1998). In this research, only one hidden layer, or the conventional three layer network is employed.

For a forecasting using a three-layer ANN, the first task is to construct the network model. This includes the decision of the three important variables: the node numbers of input layer, hidden layer and output layer. All these numbers are largely problem dependent, and there is no simple rule to decide these. As mentioned by Zhang et al. (1998), the design of an ANN is more of an art than a science.

The number of input nodes is actually the number of the input data. Superficially, the more the number of inputs the better of the

forecasting result due to more inputs might give the network more information. But, too many nodes in the input (hidden/output) layers may cause the convergence problem, and may not provide the best results. As it can be seen later, the choice of numbers of inputs, hidden and output layer nodes is a vital factor to a success of the ANN application.

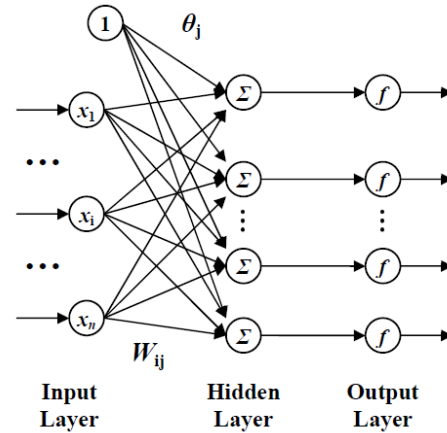

Figure 1 3-layer artificial neural network

The conventional three-layer feed-forward network is shown in Figure 1. The input layer is a layer that passes the input data into the network. In the hidden layer, the data is weighted and summed. In the output layer, a nonlinear (or linear) manipulation via an activation function is performed and output from the network.

A 3-layer ANN can be represented virtually and mathematically by the layers, the weights, biases, and summation, linear/nonlinear manipulations. Let W_{ij} and θ_j be the weights and biases for the ANN, where $i (=1, 2, \dots, n)$ and $j (=1, 2, \dots, p)$, and n and p are the nodes in the input/hidden and output layer, respectively. So the constructed input vector and output vector are given by $\mathbf{X} = (x_1, x_2, \dots, x_n)$ (input) and $\mathbf{T} = (t_1, t_2, \dots, t_p)$ (target).

The feed-forward network works in the following way. In the hidden layer, the manipulation is weighting input data and then summing them,

$$H_j = \sum_{i=1}^n W_{ij} x_i + \theta_j \quad (j=1, 2, \dots, p) \quad (1)$$

In the output layer, an activation function, f , is employed to convert the data, H_j , from the hidden layer to the output data, O_j , for the network,

$$O_j = f(H_j) \quad (j=1, 2, \dots, p) \quad (2)$$

where f is an activation function.

As in many other ANN applications, the activation function here is chosen as the sigmoid function,

$$f(x) = \frac{1}{1 + \exp(-x)} \quad (3)$$

For training the network to update the weights and biases, a method called back-propagation is mostly employed. The general idea of the back-propagation is get the error in the output layer, and the error propagates back to the hidden layer and then to the input layer, at which the weights and biases are updated. The feed-forward calculation and the back-propagation algorithm form a most useful artificial neural network in a mathematical way, and the process continues until some criterion is reached.

The back-propagation algorithm first calculates the error in output layer, which is the difference between the output values and the targets,

$$E = \frac{1}{p} \sum_{j=1}^p (t_j - O_j)^2 \quad (4)$$

This is a standard error between the two series (output and target). The

network error calculation in (Eq.4) is a little different from many conventional definitions of network error in many other papers, where the error calculation is only formulated for the convenience of the back-propagation derivation, but the (Eq.4) may serve two purposes: for the derivation of the back-propagation algorithm and for a standard error comparison, where the influence of the number of the output data has been removed.

Based on the network error, the modifications to the weights for the hidden layer have a form

$$\Delta W_{ij} = -\eta \frac{\partial E}{\partial W_{ij}} \quad (5)$$

and

$$\frac{\partial E}{\partial W_{ij}} = \frac{\partial E}{\partial O_j} \frac{\partial O_j}{\partial W_{ij}} \quad (6)$$

with

$$\begin{cases} \frac{\partial E}{\partial O_j} = -2(t_j - O_j) / p \\ \frac{\partial O_j}{\partial W_{ij}} = \frac{\partial O_j}{\partial H_j} \frac{\partial H_j}{\partial W_{ij}} = f'(H_j) x_i \end{cases} \quad (7)$$

Hence

$$\Delta W_{ij} = \alpha(t_j - O_j) f'(H_j) x_i \quad (8)$$

where η is a constant for weights updating and α is the training rate,

$$\alpha = 2\eta / p.$$

The modifications to the biases, θ_j , for the hidden layer can be done in a similar way,

$$\Delta \theta_j = -\eta \frac{\partial E}{\partial \theta_j} \quad (9)$$

Hence,

$$\Delta \theta_j = \alpha(t_j - O_j) f'(H_j) \quad (10)$$

Defining the training error as

$$E_j = (t_j - O_j) f'(H_j) \quad (11)$$

Then the updated weights and biases ($W_{ij}^{new}, \theta_j^{new}$) are

$$\begin{cases} W_{ij}^{new} = W_{ij}^{old} + \alpha E_j x_i \\ \theta_j^{new} = \theta_j^{old} + \alpha E_j \end{cases} \quad (i = 1, 2, \dots, n. \quad j = 1, 2, \dots, p) \quad (12)$$

CRITERIA OF SHORT-TERM PREDICTION

Similar to the definitions in Makarynsky (2004), two values are used to assess the goodness of the short-term predictions. The first of the value is the commonly used correlation coefficient which is a value to assess the correlation between the predictions and the target data as,

$$R = \frac{\sum_{i=1}^N (x_i - \bar{x})(y_i - \bar{y})}{\sqrt{\sum_{i=1}^N (x_i - \bar{x})^2 \sum_{i=1}^N (y_i - \bar{y})^2}} \quad (13)$$

where x_i are the predictions, and \bar{x} is the average of the predictions. y_i is the target data and \bar{y} is the average of the targets.

The correlation coefficient largely indicates the accuracy of the phase prediction, but not the relative amplitude. A unit value of correlation coefficient given by (Eq.13) means that the prediction is perfectly within the phase of the target data, but not necessarily with same amplitude.

A second value is desirable to compare the closeness between two signals, defined as the root relative error (RRE),

$$RRE = \sqrt{\frac{\sum_{i=1}^N (y_i - x_i)^2}{\sum_{i=1}^N (y_i - \bar{y})^2}} \quad (14)$$

rather than the root mean square error (RMSE) used by Makarynsky (2004). The reason that the root relative error is used is to make the prediction error comparable to the standard deviation of the targets, thus it is supposed to remove the effect of the amplitude of the reference/target data. Regardless of the amplitude of the data series, the relative error defined in (Eq.14) can be a very good indication of the closeness of two data series. For a very good prediction, RRE should be very small. It will be seen that (Eq.14) could give comparable results for the signals with very different amplitudes.

NUMERICAL STUDIES

Prediction Model

As mentioned previously, the forecasting method is to use the recorded time series data to predict the future behaviour. Suppose we have a recorded time series, $\mathbf{X} = (x_1, x_2, \dots, x_n)$, where x_n is the newest measured data, then the forecasting is to predict the future data x_{n+1} (one step prediction), x_{n+2} (two step prediction), x_{n+3} (three step prediction), and so on.

However, for the purpose of training and forecasting, the construction of a predictive model for the ANN is a little different. Suppose there are n input data taken from the measured data, $\mathbf{X} = (x_1, x_2, \dots, x_n)$, (note: x_n is not the newest measured data). By using the newest recorded data, x_{n+1} , a target series $\mathbf{T} = (t_1, t_2, \dots, t_p) = (x_{n+2-p}, x_{n+3-p}, \dots, x_{n+1})$ can be constructed. The first step in forecasting is to use the targets and the input data to train the network. Once the training is finished, the newest measured record x_{n+1} is then used to update the input data series. Together with the trained weights and biases, it is able to predict a new value, a predicted value, \hat{x}_{n+2} (one-step prediction). If \hat{x}_{n+2} is further taken as a newest "input data" for renewing the input data and performing a further prediction, a two-step prediction, \hat{x}_{n+3} , is obtained, and so on.

Once the prediction process in a time step is finished, a new measured value x_{n+2} is then used to renew the target series whilst x_{n+1} to renew the input series for a new step of network training and prediction. The process is repeated until the entire forecasting is complete.

Data Confinement/Normalisation

For ANN application, confinement/normalisation is a step to prepare the input data. If a sigmoid function is chosen as the activation function, the network output is between 0 and 1. In this regard, the input and target data must be confined within the same range of values, i.e., a data normalisation as following:

$$x_i = (y_i - \min) / (\max - \min) \quad (15)$$

where y_i is the measured data ($i = 1, 2, \dots, n$), \max and \min is the maximal and minimal values of the time series (y_1, y_2, \dots, y_n), and x_i is the normalised data.

However, for convergence in the training of the network, it is better to confine the input data to a smaller range. For example, a range of 0.2-0.8 can be used, to avoid the training process becoming locked in the local minimum or maximum, where the gradient of activation function is virtually 0, thus the updating of weights and biases becomes very slow, or even impossible. The training convergence also has the same problem. A finding in this research is that an appropriate range of confinement may give better prediction.

A linear confinement can be made as

$$x_i = (1 - 2 \times cfn)(y_i - \min) / (\max - \min) + cfn \quad (16)$$

where cfn is the smallest confined value for the input data. In this research, it has been found the confinement of 0.2-0.8 to the input data gives very good results/predictions.

Convergence

After an appropriate confinement in the input/target data, it is found that the convergence becomes very fast due to the fact of the avoidance of the local maximum and minimum, even though large numbers of nodes in the input and output layers are used. Figure 2 shows the convergence of the training process. The input layer has 2000 nodes, hidden/output layer has 500 nodes. The residual reaches 10^{-9} in about 1000 steps. If the neural nodes are reduced, the convergence becomes faster.

Perceptrons

Perceptrons are the nodes in the layers in the ANN. In a sense, a large number of perceptrons may give more information to the ANN, thus better forecasting is expected. This does not however happen in practical applications. For a good forecasting, the number of nodes in each layer must be chosen appropriately. The reason for this may be that the far-away data (old data) have no significant impact to the future data. In reality, especially for the prediction in this context, the perceptron numbers in input/hidden/output layers are best set between 20 and 60. It is believed that the fewer input data mean the data contain only newest information, which may be more relevant to the near future behaviour.

In Figure 1 for the ANN used in this research, the perceptrons of input layer and the perceptrons of hidden/output layer could be chosen as the same or different numbers. The numerical results show that the same numbers of perceptrons in the input and in the hidden/output layer give best prediction.

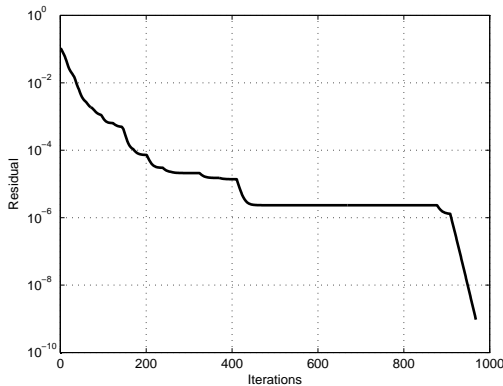

Figure 2 Training residual

Residual/Iterations

The residual in the training algorithm is the criterion that the network training error reaches. It is probably true that the smaller value of the residual that the network reaches, the better the prediction. For example, for a residual of 10^{-6} , the network may give better forecasting results than that of 10^{-3} , but a residual of 10^{-9} might not give better predictions than that of 10^{-6} . For a good prediction in this paper, the residual is normally set as 10^{-5} or 10^{-6} .

However, for a practical ANN prediction, residual may not be the best choice, because, to reach the respective training accuracy, different iterations may be needed. In an extreme situation, the ANN may not converge during the period of getting a new data (the sampling period). Alternatively, a fixed iteration is proposed in this regard for each time step, regardless of the training accuracy. It can be seen later that this approach works well.

Tuning of ANN Parameters

Many factors may affect the ANN prediction and so it is necessary to tune the parameters in a neural network before a formal prediction. These parameters include the perceptrons of the input/hidden/output layers, the confinement, the iterations/iterative residual, the activation function, the training rate and so on.

Generally, the perceptrons of the input layer may decide how much information has been provided to the network; the nodes of the hidden/output layer mainly decide the predicting model of the ANN. The confinement of the input data serves twofold purposes: avoiding the local maximum/minimum in the iterative/training process (hence accelerating the iterative convergence), and preparing data for a better ANN prediction.

The iteration or iterative residual may be decided by the practical requirement. In the context of this paper, it is found that the iteration or iterative residual is best chosen as an appropriate value. The large iteration or very small iterative residual may not be the best choice to improve the prediction, but only to increase the computational burden.

In the tuning of the ANN parameters, it is noticed that the sigmoid function performs very well in both training and predicting. It not only provides best convergence in updating the weights and biases, but gives best prediction when compared to other linear or non-linear activation functions. It is probably the reason why people use sigmoid function more than any other activation functions in constructing an ANN.

An appropriate training rate is preferable. A small training rate is good for the stability of the iterative process, but slows the convergence of training process; a large training rate increases the updating of weights/biases, but may cause convergence problem.

It is not an easy job in getting the best parameters for an ANN and trial-and-error is a useful method. Fortunately, the tuned parameters work over a large range of data as it is found in this research. The tuned parameters are given as following unless it is stated otherwise.

Perceptrons of input layer: $n=32$;
 Perceptron of hidden/output: $p=32$;
 Confinement: $cfn=0.2$ (0.2-0.8);
 Iteration/iterative residual: $it=100/eps=10^{-5}$;
 Activation function: sigmoid function;
 Training rate: $\alpha=0.05$.

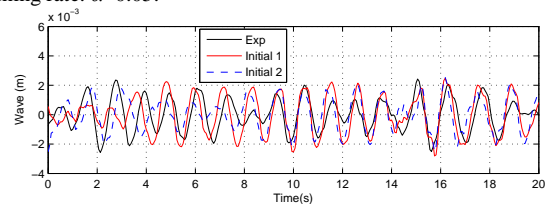

(a) Prediction at early stage

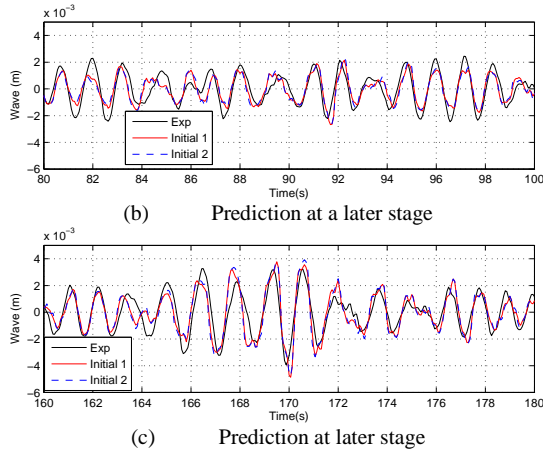

Figure 3 Influence to the prediction by initial weights and biases

Initialisation of weights and biases

Conventional initialisation of weights/biases is normally generated randomly by the computer. However, even for a very small residual or a large iteration for the network training, the trained weights and biases may give different predictions during the first predictive steps. It is understandable that for the first trained weights/biases may not be the correct ones. It is very likely that in a nonlinear dynamic system, the different initial conditions may lead different solutions. In Figure 3, it can be seen that the first 10 seconds of prediction, two different sets of initial weights/biases yield quite different predictions. However, this difference gets smaller and smaller in time (see Figs 3b-3c). It can also be seen that the predictions get closer and closer to the target data. It implies that the ANN has the ability to adjust the weights/biases according to the newer information, and finally get very good sets of weights and biases for the short-term prediction. Such an ability of the ANN can be seen in some other examples in this paper.

Numerical Experiment

The numerical experiment is performed for a prediction of a sinusoidal signal (see Fig. 4). From these figures, it is interesting to see that at the early stage of prediction (up to 40 seconds), the ANN may not predict the sinusoidal signal well (similar to Fig. 3), even though the training may be of a high accuracy. It can be understood that a good trained network can not guarantee the correct or best weights and biases for prediction. The predictions in Figs. 4a-c show that the neural network keeps adjusting its weights and biases during the process of continuous incoming new information being provided. After a certain time, the network gets the entirely correct weights and biases for the prediction in this particular case, so that 1-, 3- and 5-step predictions give much similar results. This concludes that the network has finally obtained all the features for a sinusoidal signal.

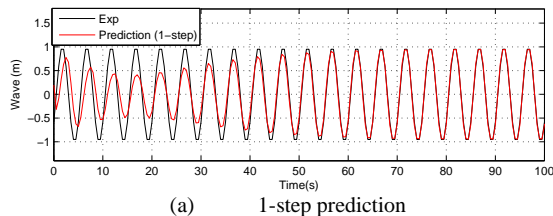

(a) 1-step prediction

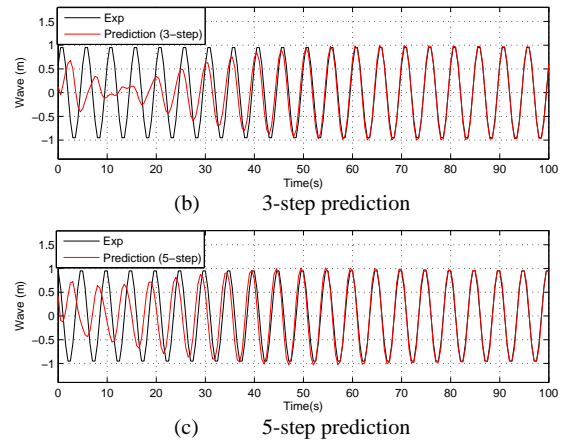

(b) 3-step prediction

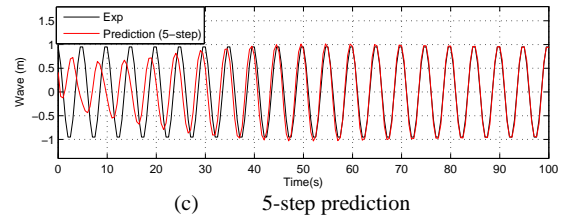

(c) 5-step prediction

Figure 4 Predictions of a sinusoidal signal

RESULTS AND ANALYSIS

A simplified oscillating wave column (Figure 5) has been tested in the Ocean Wave Basin at the Hydraulics & Maritime Research Centre (HMRC, Ireland). This simplified OWC consists of a pipe with a diameter of 0.11m which is surrounded by a float of 0.25m. diameter. The device is an axisymmetric floating body, which has a weight of 6.6kg, with a roll/pitch natural period of 4.62 seconds, a heave natural period of 1.02 seconds, and an oscillating water period in the column of 1.62 seconds.

This device has been tested in regular and irregular waves, in order to get a better understanding of the floating OWC from the standpoints of hydrodynamics and aerodynamics. The measurements include the motions of 6 degrees of freedom, the internal water surface in the column, and the airflow through an exit at the top of the water column. The measurements provide the useful data for the comparisons of the ANN predictions.

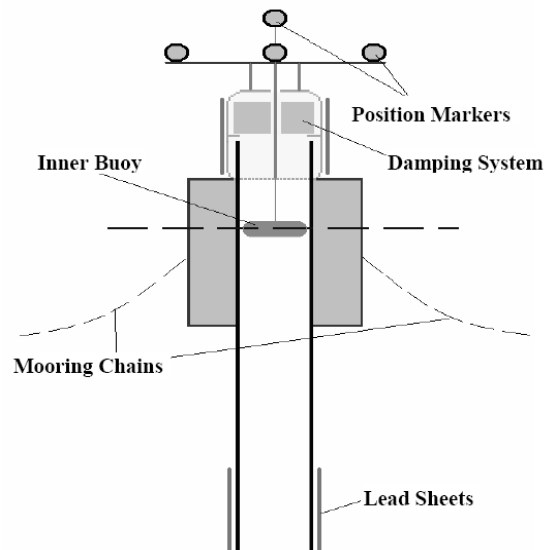

Figure 5 The simplified oscillating water column tested at HMRC

Short-term Prediction of Airflow

The predictions of the airflow have been made for two damping cases for the simplified OWC, namely zero damping and 50% damping. Table 1 lists the correlation coefficients and the root relative error. For the two different setups, the predictions are both good (see Figs. 6 and 7).

From Table 1, the correlation coefficients are very high for the one-step prediction, and the correlation coefficients become smaller with the increasing prediction steps. However, the correlation coefficient is still about 0.7 for the 5 step prediction, which may be a quite good prediction. This is confirmed by the figures 6e and 7c.

Table 1 Goodness comparison of short-term predictions (pre_1 to pre_5 mean 1- to 5- step ahead predictions)

Damping		Pre_1	Pre_2	Pre_3	Pre_4	Pre_5
Zero	R	0.975	0.903	0.806	0.732	0.677
	RRE	0.223	0.442	0.612	0.706	0.763
50%	R	0.966	0.899	0.862	0.852	0.846
	RRE	0.261	0.447	0.518	0.535	0.545

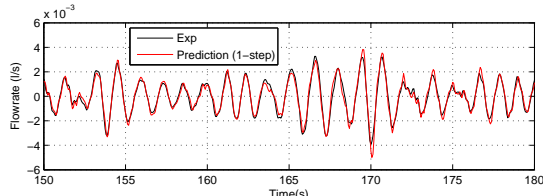

(a) one-step prediction

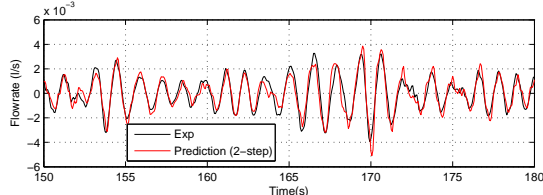

(b) two-step prediction

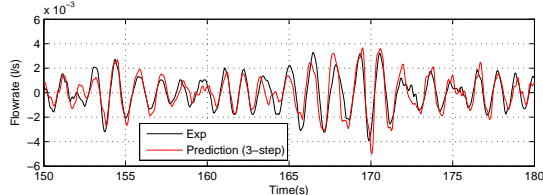

(c) three-step prediction

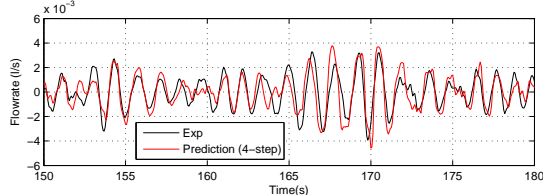

(d) four-step prediction

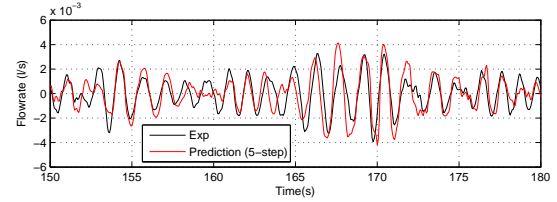

(e) five-step prediction

Figure 6 Short-term Predictions of Airflow (zero damping)

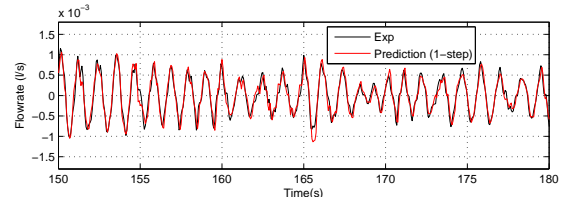

(a) one-step prediction

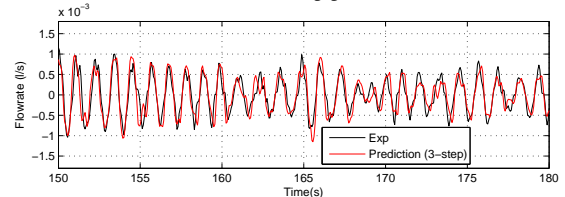

(b) three-step prediction

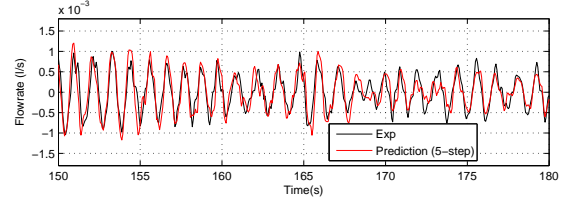

(c) five-step prediction

Figure 7 Short-term predictions of Airflow (50% damped airflow)

Short-term Predictions of Motions

Motion predictions have shown better results than those of airflow. The motions with longer periods, such as surging, swaying, rolling, pitching and yawing, have higher accuracy in prediction (see table 2 and figures 8a-b and d-f). The heaving motion and the internal surface in water column (see figures 8c and 9) have similar characteristics to the airflow prediction. Generally, the predictions are more difficult for those with shorter periods.

Table 2 Short-term predictions of motions of the floating OWC

Motion		Pre_1	Pre_2	Pre_3	Pre_4	Pre_5
Surge	R	0.997	0.990	0.971	0.938	0.890
	RRE	0.077	0.143	0.240	0.353	0.469
Sway	R	0.998	0.992	0.982	0.968	0.954
	RRE	0.064	0.132	0.202	0.267	0.325
Heave	R	0.990	0.965	0.910	0.828	0.740
	RRE	0.145	0.273	0.436	0.599	0.728
Roll	R	0.992	0.981	0.966	0.945	0.916
	RRE	0.133	0.201	0.297	0.414	0.528
Pitch	R	0.990	0.978	0.952	0.904	0.828
	RRE	0.148	0.212	0.318	0.459	0.623
Yaw	R	0.989	0.981	0.966	0.945	0.916
	RRE	0.153	0.199	0.263	0.337	0.418

Table 3 Short-term prediction of water height in column

	Pre_1	Pre_2	Pre_3	Pre_4	Pre_5
R	0.986	0.941	0.851	0.757	0.672
RRE	0.171	0.354	0.554	0.696	0.790

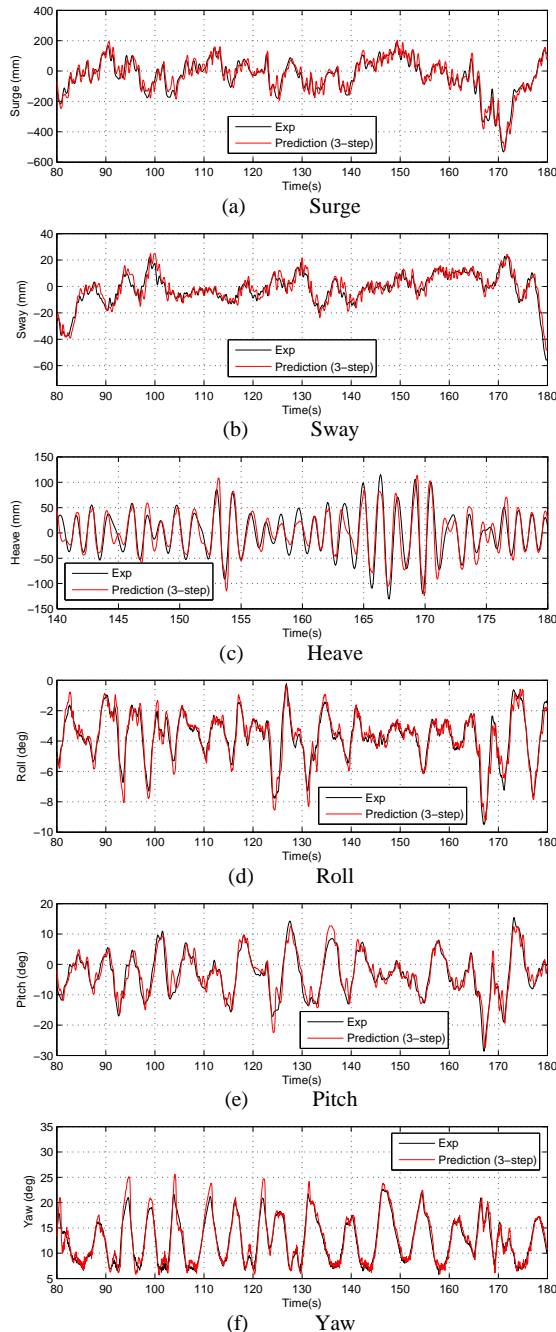

Figure 8 Short-term predictions of motions of the floating OWC

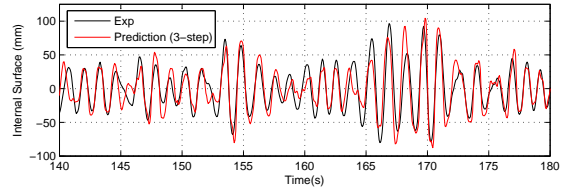

Figure 9 Short-term prediction of water height in column

CONCLUSIONS

The research applies an artificial neural network to the short-term prediction of the airflow and of the 6-dof motions for a floating OWC device. A systematic study has been made for the ANN forecasting. The neural network has been tuned for a better prediction. From this research, the following conclusions can be drawn.

- 1) The simple 3-layer ANN presents a very good capability of predicting the future behaviour. The ANN can adjust and improve the weights and biases according to the continuing incoming information. After some steps of predictions and corrections, the network usually obtains very good weights and biases for predictions. That suggests that the ANN may be allowed to adjust the weights and biases during the prediction process, while the early predictions may not be necessary to be very accurate.
- 2) The perceptrons of the ANN do not need to be very large. For the ANN employed in this research, the numbers of input layer and of hidden/output layer are both selected as 32. These relative small perceptrons can provide fast convergence as well as good prediction.
- 3) An appropriate confinement of the input data is good for both the neural network training and prediction, and it is also a good practice to avoid the local minimum/maximum which may cause a convergence problem in network training.
- 4) For a practical application, it is possible to set a fixed iteration for the network, rather than a residual. This approach works well in this research. This approach works well in the practical applications, and in the case of slow convergence.
- 5) The tuned network parameters can work over a large range of the data for a good prediction, though the data types and periods may be very different.

ACKNOWLEDGEMENTS

The authors would like to thank the Charles Parsons Initiative Program of Department of Communications, Energy and Natural Resources, Ireland and Science Foundation Ireland for which the first author holds the research fellowship.

REFERENCES

- Adya, M, Collopy, F (1998), "How Effective Are Neural Networks at Forecasting and Prediction? A Review and Evaluation," *Journal of Forecasting*, Vol. 17, pp.481-495.
- Akzhalova, A, Altayeva, A, Duzbayev, N (2007), "Model Driven Prediction and Control," *Journal of Object Technology*, Vol. 6, No.11, Special Issue on Advanced in Quality of Service Management, Dec. 2007.
- Beirao, P, Mendes, MJGC, Valerio, D, Costa, JS (2007), "Control of the Archimedes Wave Swing Using Neural Networks," the 7th European Wave and Tidal Energy Conference (EWTEC 2007), Porto, Portugal, 11-13 Sep. 2007.

- Dia, H (2001), "An Object-Oriented Neural Network Approach to Short-Term Traffic Forecasting," *European Journal of Operational Research*, Vol. 131, pp.253-261.
- Deo, MC, Naidu, S (1999), "Real Time Wave Forecasting Using Neural Networks," *Ocean Engineering*, Vol. 26, pp.191-203.
- Deo, MC, Jha, A, Chaphekar, AS, Ravikant, K (2001), "Neural Networks for Wave Forecasting," *Ocean Engineering*, Vol. 28, pp.889-898.
- Chapman, AJ (1994), "Stock Market Trading Systems through Neural Networks: Developing a Model," *International Journal of Applied Expert Systems*, Vol. 2(2), pp.88-100.
- Elsner, J (1992), "Predicting Time Series Using a Neural Network as a Method of Distinguishing Chaos from Noise," *Journal of Physics A: Math. Gen.* Vol.25, pp.843-850.
- Felix, AG, Schraudolph, NN, Schmidhuber, J (2002), "Learning Precise Timing with LSTM Recurrent Networks," *Journal of Machine Learning Research*, Vol. 3, pp.115-143.
- Furtado, HCM, Velho, HFC, Macau, EEN (2008), "Data Assimilation: Particle Filter and Artificial Neural Networks," *Journal of Physics: Conference Series*, Vol. 135, 012073.
- Fusco, F, and Ringwood, J (2009), "A Study on Short-Term Sea Profile Prediction for Wave Energy Applications", the 8th European Wave and Tidal Energy Conference (EWTEC 2009), Uppsala, Sweden, 7-10 Sep. 2009.
- Haddara, MR, Xu, J (1999), "On the Identification of Ship Coupled Heave-Pitch Motions Using Neural Networks," *Ocean Engineering*, Vol.26, pp.384-400.
- Huang, L, Hu, J, Hirasawa, K (2006), "A Quasi-ARMA model for Financial Time Series Prediction," Proceedings of the 38th ISICIE International Symposium on Stochastic Systems Theory and its Applications, Suwa, Nagano, Japan, Nov. 9-10, 2006.
- Huang, M, Peng, G, Zhang, J, Zhang, S (2006), "Application of Artificial Neural Networks to the Prediction of Dust Storms in Northwest China," *Global and Planetary Change*, Vol.52, pp.216-224.
- Hulthen E (2004), "Improving Time Series Prediction Using Recurrent Neural Networks and Evolutionary Algorithms," Thesis for the Degree of Master of Science, Department of Machine and Vehicle Systems, Chalmers University of Technology, Goteborg, Sweden.
- Karanasos M (2001), "Prediction in ARMA Models with Garch in Mean Effects," *Journal of Time Series Analysis*, Vol. 22, No.5, pp.555-576.
- Keyvan, S, Durg, A, Nagaraj, J (1997), "Application of Artificial Neural Networks for the Development of a Signal Monitoring System," *Expert System*, Vol. 14, No.2, pp.69-79.
- Kim, D, Park, W (2003), "Reliability Based Design of Breakwater Armor Layer Using Neural Network," Proceedings of the 13th International Offshore and Polar Engineering Conference, Honolulu, Hawaii, USA, May 25-30, 2003, pp.487-492.
- Kioka, S, Kubouchi, A, Saeki, H (2003), "Training and Generalization of Experimental Values of Ice Scour Event by a Neural-Network," Proceedings of the 13th International Offshore and Polar Engineering Conference, Honolulu, Hawaii, USA, May 25-30, 2003, pp.539-544.
- Lee, TL (2008), "Back-Propagation Neural Network for the Prediction of the Short-Term Storm Surge in Taichung Harbor, Taiwan," *Engineering Applications of Artificial Intelligence*, Vol.21, pp.63-72.
- Lewis, T (2009), "Testing Procedures and Facilities for Ocean Energy Development", http://www.eve.es/jornadas/ponencias_energia_marina_09/Lewis_to_ny.pdf (cited on 10th March 2010).
- Makarynsky, O (2004), "Improving Wave Predictions with Artificial Neural Networks," *Ocean Engineering*, Vol.31, pp.709-724.
- Mandal, S, Prabaharan, N (2006), "Ocean Wave Forecasting Using Recurrent Neural Networks," *Ocean Engineering*, Vol.33, pp.1401-1410.
- Moody, J (1995), "Economic Forecasting: Challenges and Neural Network Solutions," Keynote Talk presented at the International Symposium on Artificial Neural Networks, Hsinchu, Taiwan, Dec. 1995.
- Nakamura, M, Ohmachi, T, Shima, T (2003), "Model Experiments on Dynamic Positioning System Using Neural Network Controller," Proceedings of the 13th International Offshore and Polar Engineering Conference, Honolulu, Hawaii, USA, May 25-30, 2003, pp.203-209.
- Price, AA, Wallace, AR (2007), "Non-linear Methods for Next Wave Estimation," the 7th European Wave and Tidal Energy Conference (EWTEC 2007), Porto, Portugal, 11-13 Sep. 2007.
- Rojas, R (1996), "*Neural Networks: A Systematic Introduction*" Springer-Verlag, Berlin.
- Rojas, I, Valenzuela, O, Rojas, F, Guillen, A, Herrera, LJ, Pomares, H, Marquez, L, Pasadas, M (2008), "Soft-Computing Techniques and ARMA Model for Time Series Prediction," *Neurocomputing*, Vol. 71, pp.519-537.
- Teschl, R, Randeu, WL (2006), "A Neural Network Model for Short Term River Flow Prediction," *Natural Hazards and Earth System Sciences*, Vol. 6, pp.629-635.
- Tsai, J, Tsai, C (2009), "[Wave Measurements by Pressure Transducers Using Artificial Neural Networks](#)," *Ocean Engineering*, (electronic version).
- Yan, H, Yin, F, Zhu, G, Ajlouni, M, Kim, J (2006), "Adaptive Prediction of Internal Target Motion Using External Motion: a Technical Study," *Phys. Med. Biol.*, Vol.51, pp.31-44.
- Yao, J, Tan, CL (2001), "Guidelines for Financial Forecasting with Neural Networks", Proceedings of International Conference on Neural Information Processing, Shanghai, China, 14-18 November, 2001, pp757-761.
- Zhang, G, Patuwo BE, Hu, MY (1998). "Forecasting with Artificial Neural Networks: The State of the Art," *International Journal of Forecasting*, Vol. 14, pp.35-62.