

Title	Multimedia communications for autonomous drones
Authors	Sarvi, Batoul
Publication date	2022
Original Citation	Sarvi, B. (2022) 'Multimedia communications for autonomous drones', The Boolean: Snapshots of Doctoral Research at University College Cork, 6, pp. 52-58. doi: 10.33178/boolean.2022.1.9
Type of publication	Article (peer-reviewed)
Link to publisher's version	https://journals.ucc.ie/index.php/boolean/article/view/boolean-2022-10 - 10.33178/boolean.2022.1.9
Rights	© 2022, the Author(s). This work is licensed under a Creative Commons Attribution-NonCommercial-NoDerivatives 4.0 licence (CC BY-NC-ND 4.0) - https://creativecommons.org/licenses/by-nc-nd/4.0/
Download date	2025-04-24 09:31:26
Item downloaded from	https://hdl.handle.net/10468/14671

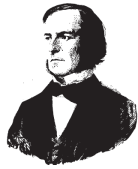

UCC

University College Cork, Ireland
Coláiste na hOllscoile Corcaigh



Multimedia Communications for Autonomous Drones

Batoul Sarvi^{1,*}

¹*School of Computer Science and Information Technology, University College Cork*

**Corresponding author: b.sarvi@cs.ucc.ie*

Abstract

In recent years, there has been significant growth in multimedia communication on drones. The first thing that comes to every researcher's mind is what requirements are for multimedia communication to be acceptable for existing scenarios on UAVs? Because of the noisy wireless channel and long distance between UAVs, providing reliable and real-time multimedia communications on UAVs stands at the top of the requirements list. To the best of our knowledge, mobile edge computing and cross-layer error control have significant possibilities to provide a better quality of multimedia communication on UAVs. Finally, utilizing the aforementioned edge network techniques can increase the efficiency of the overall system, enhance the video quality, maximize the usage of network resources, and save energy in multimedia communication on UAV networks.

Keywords: Multimedia Communication, UAV, Drone, Edge Network Techniques, Mobile Edge Computing.

My soul is in the sky.

— *William Shakespeare*

What is a drone?

An unmanned aerial vehicle (UAV), commonly known as a drone, is an aircraft without any human pilot on board. UAVs are a component of an unmanned aircraft system (UAS), which includes: UAV, Ground Control Station (GCS), and Radio Controller/Transmitter.

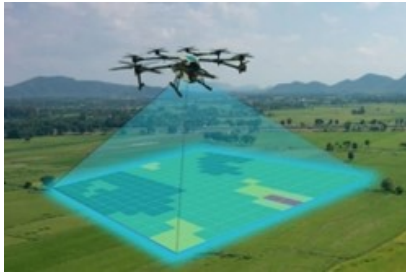

Figure 1: UAV in precise agriculture [Justin Law-2019]



Figure 2: Swarm of drones in Fire Suppression Activities. [Elena Ausonio - 2021]



UAV



Ground Control Station



Radio Controller/Transmitter

Multimedia Communication on UAV

Drones have experienced an unprecedented growth in civilian and military applications over the past decade. This momentum stems from their flexibility, ease of installation, low maintenance costs, versatility, and relatively small operating costs. Integrating cameras with UAVs enables them to record high-quality videos and/or seamlessly share them with GCS or clients for manual inspection and further analysis. As a result, multimedia communications on UAV scenarios play a vital role in a new set of applications, including environmental monitoring (e.g. conservation of biodiversity), precision agriculture, search and rescue operations, target tracking, surveillance systems, and firefighting. Some examples of these applications are demonstrated in Figure 1, and 2.

However, multimedia communications on UAV networks lead to a lot of challenges. UAVs are mobile, and they may face many obstacles during their travels, so sending a lot of compressed video to GCS may cause some end-to-end delays or errors. As a result, in the vast majority of applications, UAVs struggle to send reliable and high-quality video to ground receivers in UAV networks in real time. Assume you are a police officer and you're tracking a group of bank robbers who are driving a car. Even if they drive on a crowded motorway, you can track their car if you have a drone with a camera. In this scenario, the important thing is that you provide a high-quality, and live video from your drone. You will frequently experience errors when streaming a video because of obstacles including trees, skyscrapers in urban areas, or even interfering signals from other mobile devices. In conclusion, high-quality video is a critical component for multimedia communication on UAVs.

Furthermore, UAVs have limited battery capacity, but video and image applications require a lot of energy and communication resources to record and transport data to the GCS. This

study looks into how to overcome these challenges using cutting-edge technologies like mobile edge computing (MEC) and cross-layer error control techniques on UAV networks.

Edge Network Techniques

Edge computing is a distributed computing paradigm that brings computation and data storage closer to the sources of data. This is expected to improve response times and save bandwidth. Edge technologies are promising because they can be used in mobile, wireless, and wired scenarios, and they can be implemented on both software and hardware platforms at the network edge, close to the data source. A network with edge layer concepts is shown in Figure 3.

Mobile Edge Computing

Regarding MEC technology, there can be a significant improvement in the performance of UAV networks by offloading the computation part from the core network to MEC servers. Consider the situation when your drone needs to send a video to a police station in order to get operating directions, but there are many Base Transceiver Stations (BTSs) between the drone and the operations command center. If the control part is transferred to the drone, it will have improved tracking capabilities. This is a very basic demonstration of how MEC can be utilized on a drone.

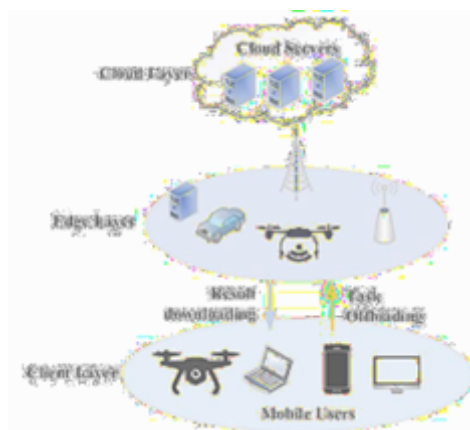

Figure 3: UAV assisted MEC architecture [WEN Zhang et al – 2020]

We can also have autonomous drones with video processing that fly entirely independent from the core network thanks to the MEC architecture. Completely disconnected drones, on the other hand, are not ideal for applications that require a swarm of drones to work together. As a result, a well-balanced combination of drone-based processing and edge-based processing on UAV networks can save significant wireless bandwidth and indeed enhance scalability.

Another example of a comparison between MEC node computing and onboard UAV computing is face detection in a crowded environment. Face-recognition UAVs can be used for crowd surveillance. MEC is an appropriate platform for doing video analytics at the network's edge, such as face recognition or computer vision algorithms, while avoiding overloading the

core network and ensuring low end-to-end delay. MEC in Figure 4 represents this schematically. The simulation findings show that offloading computations saves energy and improves system responsiveness in detecting and distinguishing suspicious people in a crowd. Improvement in the performance becomes more noticeable in longer videos and also when the number of profiled persons is high.

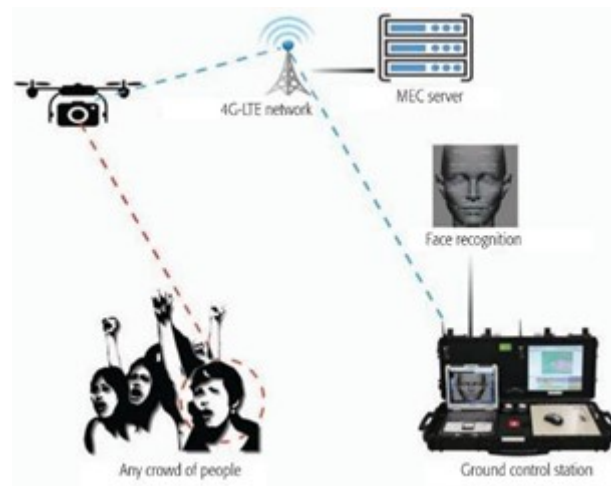

Figure 4: High-level diagram of the face detection scenario [N. Motlagh et al - 2017].

Error Control Mechanisms

Although MEC affects the quality of experience, it is not able to control errors on the UAV networks. The error management on video transmission has a significant efficiency over noisy channels on drone networks. Error resilience is important for multimedia streaming in networks with an unstable topology such as drone networks. There are two types of general error resilient methods: first, classical error control and recovery methods, such as Forward Error Correction (FEC) and Automatic Repeat re-Quest (ARQ); and second, error concealment methods, which can hide errors and reduce the probability of errors. FEC and ARQ are methods that are considered for the purposes of this research. In the following, I explain what these techniques mean.

- **Forward error correction (FEC).** FEC is an error correction technique to detect and correct a limited number of errors in transmitted data without the need for retransmission. In this method, the sender sends a redundant error-correcting code along with the data frame. The receiver performs necessary checks based upon the additional redundant bits. Therefore, determining the amount of redundant code is the important and challenging part of this mechanism (see Figure 5).

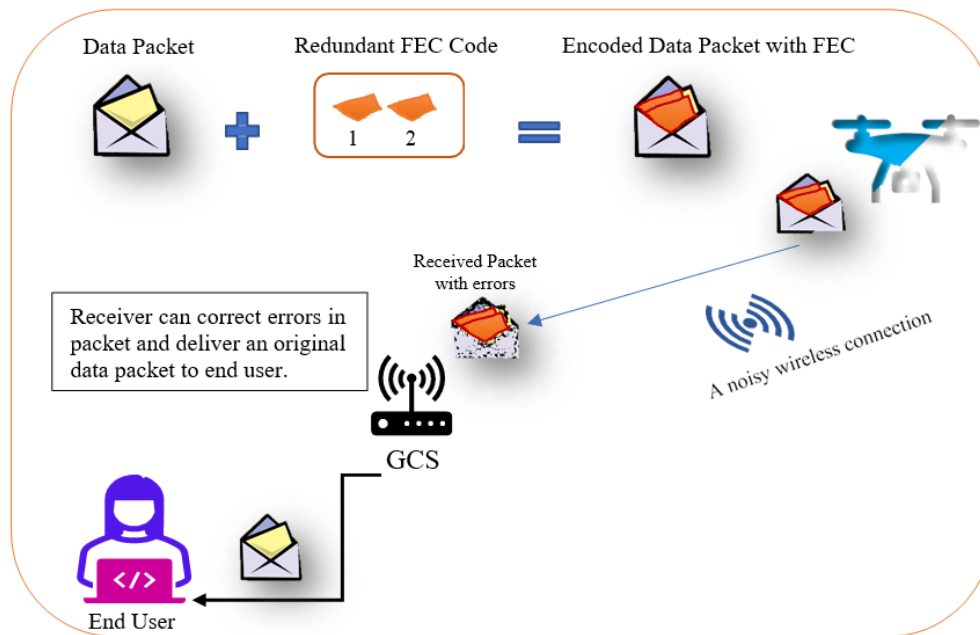

Figure 5: Sample encoded packet with redundant FEC code.

- Automatic Repeat re-Quest (ARQ).** ARQ is an error-control mechanism for data transmission which uses acknowledgements (or negative acknowledgements) and timeouts to achieve reliable data transmission over an unreliable communication link. If the sender does not receive an acknowledgment before the timeout, it re-transmits the packet until it receives an acknowledgment or exceeds a predefined number of retransmissions. So, the number of retransmissions is a vital part in ARQ algorithm. The Figure 6 shows a simple example of using ARQ mechanism.

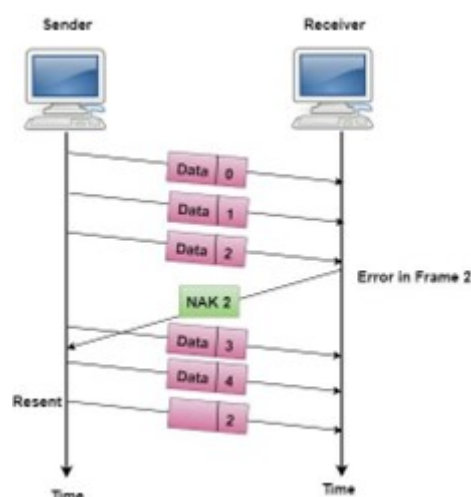

Figure 6: Sample of retransmission in ARQ

The advantages of both approaches can help UAV networks increase the reliability of multi-media communication. The mentioned important sections in error control techniques, however,

raise certain research questions. For example, how can we employ FEC and ARQ at the same time? What impact does the adoption of Hybrid ARQ/FEC have on end-to-end delay and reliability? How can we determine the optimal number of retransmissions and redundancy in ARQ and FEC?

As a result, the goal of this research project is to propose an adaptive error control protocol for UAV networks that will improve overall system efficiency, improve video quality, maximize network resource utilization, and conserve energy.

Finally, we'll look into what occurs if UAVs are equipped with edge capability (either sender or relays). The next question is how much should be offloaded to MEC servers and what should be offloaded. Do we need to execute computation missions locally, or partially or completely offload tasks? If so, which part should be offloaded?

The final vision of this research is edge network support for UAV communication, which includes error control and data computation at the network's edge. Figure 7 demonstrates the envisaged final vision of this research, and we intend to work towards it.

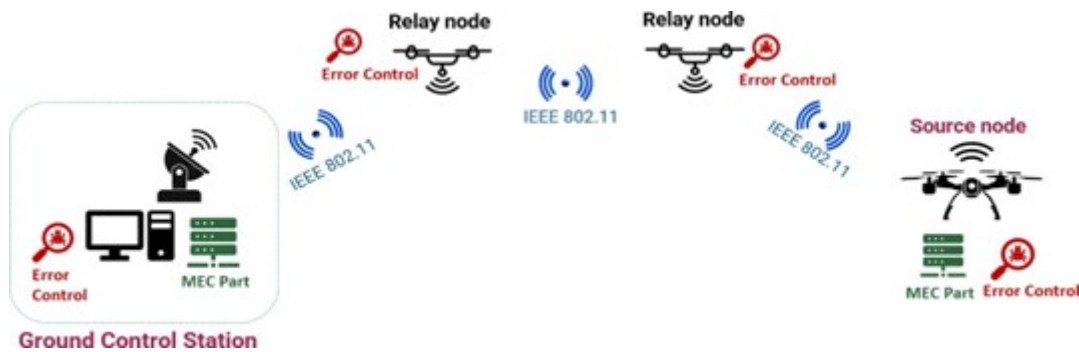

Figure 7: Envisaged final vision of error control methods for UAV communication.

Conclusions

In recent years, there has been a significant growth of multimedia communication on UAVs. The first thing that comes to every researcher's mind is what requirements are for multimedia communication to be acceptable for existing scenarios on UAVs? Because of the noisy wireless channel and long distance between UAVs, providing reliable and real-time multimedia communications on UAVs stands at the top of the requirements list. To the best of our knowledge, mobile edge computing and cross-layer error control have significant possibilities to provide a better quality of multimedia communication on UAVs. Finally, utilizing the aforementioned edge network techniques can increase the efficiency of the overall system, enhance the video quality, maximize the usage of network resources, and save energy in multimedia communication on UAV networks.

Acknowledgements

Batoul Sarvi is a second-year PhD student from the School of Computer Science and Information Technology, under the supervision of Prof. Cormac Sreenan and Dr Ahmed Zahran. The

author would like to express her sincere thanks to her supervisors for their continuous support, encouragement, and academic guidance. Also, special thanks to Mohammad for his constant love, support, and understanding.

Declaration of Interests

This PhD research would not be possible without funding provided by the SFI Centre for Research Training in Advanced Networks for Sustainable Societies (ADVANCE CRT), School of Computer Science & I.T., University College Cork under Grant No. R19784 from October 2020.