

Title	Effect of tuned mass damper on the interaction of a quarter car model with a damaged bridge
Authors	Pakrashi, Vikram;O'Connor, Alan J.;Basu, Biswajit
Publication date	2010
Original Citation	Pakrashi, V., O'Connor, A. & Basu, B. (2010). Effect of tuned mass damper on the interaction of a quarter car model with a damaged bridge. Structure and Infrastructure Engineering: Maintenance, Management, Life-Cycle Design and Performance, 6(4), 409-421. doi:10.1080/15732470701816850
Type of publication	Article (peer-reviewed)
Link to publisher's version	http://prod.informaworld.com/openurl?genre=article&issn=1573-2479&volume=6&issue=4&spage=409 - 10.1080/15732470701816850
Rights	© 2010 Taylor & Francis. This is an electronic version of an article published in Pakrashi, V., O'Connor, A. & Basu, B. (2010). Effect of tuned mass damper on the interaction of a quarter car model with a damaged bridge. Structure and Infrastructure Engineering: Maintenance, Management, Life-Cycle Design and Performance, 6(4), 409-421. doi:10.1080/15732470701816850 http://prod.informaworld.com/openurl?genre=article&issn=1573-2479&volume=6&issue=4&spage=409
Download date	2024-10-15 12:29:53
Item downloaded from	https://hdl.handle.net/10468/282



UCC

University College Cork, Ireland
Coláiste na hOllscoile Corcaigh



UCC

Coláiste na hOllscoile Corcaigh, Éire
University College Cork, Ireland



Cork Open Research Archive
Cartlann Taighde Oscailte Chorcaí

This is an electronic version of an article published in

Pakrashi, V., O'Connor, A. & Basu, B. (2010). Effect of tuned mass damper on the interaction of a quarter car model with a damaged bridge. *Structure and Infrastructure Engineering: Maintenance, Management, Life-Cycle Design and Performance*, 6(4), 409-421. doi:10.1080/15732470701816850
<http://prod.informaworld.com/openurl?genre=article&issn=1573-2479&volume=6&issue=4&spage=409>

STRUCTURE AND INFRASTRUCTURE ENGINEERING is available online at:
<http://prod.informaworld.com/openurl?genre=journal&issn=1573-2479>

CORA Cork Open Research Archive <http://cora.ucc.ie>

Effects of Tuned Mass Damper on Damaged Bridge- Accelerating Vehicle Interaction

Vikram Pakrashi, Alan O' Connor and Biswajit Basu

**Department of Civil, Structural and Environmental Engineering, Trinity College Dublin,
Ireland**

ABSTRACT: This paper considers the effects of tuned mass damper (TMD) on damaged bridge- accelerating vehicle interaction. The damage of the bridge is considered to be an open crack. The incorporation of a TMD to control the vibration response of the bridge and the vehicle has been investigated from different aspects. A simplified form for the tuning ratio of the TMD is proposed. The vibration mitigation of the peak displacement, velocity and acceleration of the damaged bridge and the accelerating vehicle using such a tuning is observed along with the effects of possible detuning of the TMD due to the progressive deterioration of the bridge. A detail parametric study is performed on the system with TMD considering the effects of vehicle velocity, vehicle acceleration and the severity of the damage of the bridge.

KEYWORDS: Tuned Mass Dampers, Open Crack, Vibration Control, Tuning Ratio, Bridge-
Vehicle Interaction

1. INTRODUCTION

The interaction between bridges and the vehicles traversing them can give rise to dynamic magnification of static effects. The magnified displacement due to vibration may be unacceptable in terms of serviceability or alternatively the consequences of amplified loading can lead to excess cracking, thereby violating a possible limit state criterion. Thus, both the vehicle and the bridge experience magnified stresses due to dynamic effects. In addition, bridge-vehicle interaction generally increases the vertical acceleration of the vehicle. This becomes a source of discomfort for the passengers since the human body is sensitive to rate of change in velocity. Installation of a proper vibration control mechanism like Tuned Mass Damper (TMD) can lower the dynamic response of the bridge and the vehicle and as a direct consequence the structure demonstrates a relative improvement in terms of serviceability. The frequency and damping ratio of the TMD is adjusted or tuned with that of the bridge in such a way that the TMD absorbs the major part of the excitation and controls the bridge-vehicle interaction, thus providing possible solutions related to the excess stress on the vehicles and the passenger discomfort due to unwanted and excessive vertical acceleration.

A huge amount of literature of varying complexity and details (both theoretical and experimental) is available on the bridge vehicle interaction technique (Abdel-Rohman and Al-Duaij (1996), Delgado and Dos-Santos (1997), Pesterev and Bergman (1997), Song et.al (2003), Da Silva, (2004)). Genin et al (1975), Hayashikawa and Watanabe (1981), Klasztorny and Langer (1990), Cai et al (1994) and Fryba (1999) have discussed the problem of a quarter car model of a vehicle moving over a flexible guideway modelled as an Euler Bernoulli beam element in details.

Den Hartog (1985) showed the efficiency of a TMD to suppress vibrations of an SDOF system under harmonic loading. With damping included, the tuning frequency and the damping become outputs of an optimisation problem. The TMDs perform satisfactorily when

the exciting frequency has a narrow window (Inman (2001)), which is often the case for a bridge vehicle interaction process. Igusa and Xu (1992) have examined both single and multiple TMDs with the natural frequency distributed over a range and have found multiple TMDs to be more effective and robust than a single one. Park and Reed (2000) have found uniformly distributed TMDs to perform better than linearly distributed ones. Yamaguchi and Harnpornchai (1993), Abe and Fujino (1994), Kareem and Kline (1995) and Wang et al (2003) have discussed the advantages of multiple TMDs over single TMD. Kwon et al (1998) and Jo et al (2001) have considered the interaction of high-speed vehicles with three span steel box girder bridges and have advocated the use of critical damping value in TMD suggested by Tsai (1993) to avoid the beating phenomenon due to inadequate damper tuning. Warburton and Ayorinde (1980) however, have previously showed that for a TMD with small mass ratio with respect to the bridge, exact tuning may turn out to be rewarding. It is observed from the literature that the improvement due to the presence of multiple TMD are often quite small in terms of the peak response, since in many of the cases the first vibration mode of the beam contributes the almost entirely to the dynamic response of a beam (Law and Zhu (2004), Yang and Lin (2005)).

However, the interaction of a damaged beam and a moving load traversing over the beam has been considered quite recently mostly for the purposes of structural health monitoring process. Majumdar and Manohar (2003) have considered a bridge system with partially immobile bearings and have identified the loss of local stiffness by proposing a time domain damage descriptor. Lee et.al (2002) have experimentally investigated the possible application of bridge-vehicle interaction data for identifying the loss of bending rigidity by continuously monitoring the operational modal parameters. Law and Zhu (2004) have

considered a simply supported beam with open and breathing cracks and discussed the dynamic behaviour of the bridge-vehicle interaction both from theory and experiment.

It is observed that the effects of TMD on a deteriorating bridge traversed by an accelerating vehicle have not been dealt with. Since the natural frequency of a deteriorating bridge changes with time, it is important to observe the corresponding effects on the tuning criteria, the possibility of detuning and the consequent malfunction of a TMD device due to such deterioration in terms of vibration control of both bridge and vehicle. Also, most of the existing literature considers a constant velocity for the traversing vehicle and hence the investigation of the effects of various vehicle accelerations for a deteriorating bridge – vehicle - TMD interaction is deemed important. This paper formulates a damaged beam with an open crack fitted with TMDs. A quarter car model of an accelerating vehicle consisting of two degrees of freedom is considered to traverse the beam. Optimized tuning parameters for the TMD following Ghosh and Basu (2006) have been computed. The modification in the tuning parameters due the presence of damage is also investigated. The effectiveness of the TMDs is considered in terms of the peak responses of the bridge and the vehicle. The efficiency of the TMD for each of such criterion is parametrically investigated for a range of velocities and crack depth ratios (CDR). The effects of an accelerating vehicle are investigated for the same criteria of vibration control. The study forms a basis to identify and emphasize the importance of damage and the acceleration of a vehicle traversing a bridge with respect to the efficiency of peak vibration reduction through the implementation of a passive TMD.

2. DAMAGE MODEL

A simply supported Euler Bernoulli beam with an open crack is modelled as two uncracked sub-beams connected through a rotational spring at the location of crack in the lumped crack

formulation. The length of the beam is L with the damage located at a distance 'a' from the left hand support of the beam. The crack depth is taken as c and the overall depth of the beam is h . The free vibration equation for both the beams on either side of the crack can be written as

$$EI \frac{\partial^4 y}{\partial x^4} + \rho A \frac{\partial^2 y}{\partial t^2} = 0 \quad (1)$$

where E , I , A and ρ are the Young's modulus, the moment of inertia, the cross sectional area and the density of the material of the beam on either side of the crack. The displacement of the beam from its static equilibrium position is $y(x,t)$, at a distance of x from the left hand support along the length of the beam at time t . The strains and stresses are concentrated at the crack tip and decay inversely proportional to the square root of the radial distance away from the crack tip (Carneiro (2000)). It is assumed that the effects of the crack are applicable in the immediate neighbourhood of the crack location and is represented by a rotational spring of equivalent local stiffness. Through the separation of variables in equation 1 and solving the characteristic equation, a general solution of the modeshapes is found as per Narkis (1994) to be

$$\Phi_L(x) = C_{1L} \text{Sin}(\lambda x) + C_{2L} \text{Cos}(\lambda x) + C_{3L} \text{Sinh}(\lambda x) + C_{4L} \text{Cosh}(\lambda x) \quad 0 \leq x < a \quad (2)$$

and

$$\Phi_R(x) = C_{1R} \text{Sin}(\lambda x) + C_{2R} \text{Cos}(\lambda x) + C_{3R} \text{Sinh}(\lambda x) + C_{4R} \text{Cosh}(\lambda x) \quad a \leq x \leq L \quad (3)$$

for the sub-beams on the left (L) and the right (R) side of the rotational spring respectively. The terms $C_{(.)}$ are integration constants arising from the solution of the separated fourth order differential equation in space. The term λ is expressed as

$$\lambda = \left(\frac{\rho A \omega^2}{EI}\right)^{1/4} \quad (4)$$

where the natural frequency of the cracked beam is ω . The displacement and the moment at the two supports of the beam are zero. Hence

$$\Phi_L(0) = 0, \Phi_L''(0) = 0, \Phi_R(L) = 0 \text{ and } \Phi_R''(L) = 0 \quad (5)$$

The continuity in displacement, moment and shear are assumed at the location of crack. These conditions can be expressed as

$$\Phi_L(a) = \Phi_R(a), \Phi_L''(a) = \Phi_R''(a) \text{ and } \Phi_L'''(a) = \Phi_R'''(a) \quad (6)$$

A slope discontinuity is present at the crack location. The slope condition is modelled as

$$\Phi_R'(a) - \Phi_L'(a) = \theta L \Phi_R''(a) \quad (7)$$

In equation 7, the term θ is the non-dimensional crack section flexibility dependent on the crack depth ratio. As per Narkis (1994) the function is considered to be a polynomial of the crack depth ratio in a non-dimensional form as

$$\theta = 6\pi\delta^2 (h/L)(0.5033 - 0.9022\delta + 3.412\delta^2 - 3.181\delta^3 + 5.793\delta^4) \quad (8)$$

The term $\delta (=c/h)$ is the crack depth ratio (CDR). The boundary conditions are substituted in the general modeshape equation and a system of eight linear equations is formed. The natural frequency of the cracked beam may be found by setting the determinant of the matrix derived from the system of equations to zero, expanding it and solving for the roots of λ numerically. In this paper, the roots were found using Brent's method in MATLAB (1994). The matrix is presented in Appendix A.1. The coefficient C_{1L} is normalized to unity, being consistent with the fact that for an undamaged beam the maxima of the first modeshape is equal to unity. The other coefficients are then found with respect to C_{1L} .

3. BRIDGE-VEHICLE-TMD INTERACTION

3.1 Description of the Problem

The bridge is modelled as a simply supported Euler Bernoulli beam with an open crack as the damage. The vehicle is modelled as a quarter car element consisting of two degrees of freedom representing the vertical motions of the wheel and the body. The quarter car is assumed to traverse the damaged beam with an acceleration f and an initial velocity u_0 . The masses of the lower and the upper degrees of freedom of the quarter car model are m_w and m_b respectively. An assembly consisting of two sets of springs (k_b, k_w) and dampers (c_b, c_w) represents the suspension system of vehicle. Angular movements of the vehicle are neglected. Tuned mass dampers are modelled to be connected to the beam with a parallel spring and damper system. For the case of multiple tuned mass dampers, the i^{th} TMD is assumed to have a spring stiffness k_{zi} and a damping of c_{zi} . The location of the i^{th} TMD on the beam from the left hand support is taken as x_i . The vehicle is assumed to be moving on a surface without losing contact with it. Bouncing, impact effects and surface roughness of the bridge pavement are not considered. The mass of the i^{th} TMD is given as m_{zi} . Figure 1 shows the model of bridge vehicle interaction with TMD installed as described in this section.

3.2 Equations of Motion

Considering the dynamic equilibrium conditions for the degrees of freedom along the displacement directions y_b , y_w and z_i (for the i^{th} TMD) the following equations are obtained

$$m_b \ddot{y}_b + c_b (\dot{y}_b - \dot{y}_w) + k_b (y_b - y_w) = 0 \quad (9)$$

$$m_b \ddot{y}_b + m_w \ddot{y}_w + c_w (\dot{y}_w + \dot{y}) + k_w (y_w + y) = 0 \quad (10)$$

$$m \ddot{z}_i + c_{z_i} (\dot{z}_i - \dot{y}) + k_{z_i} (z_i - y) = 0 \quad (11)$$

respectively. The overdots in equations 1, 2 and 3 represent derivatives with respect to time. The displacement of the beam at an instant of time t at the location x from the extreme left hand support is given by $y(x,t)$. Considering the dynamic loading factors and N number of TMDs at locations $x_1 \dots x_N$, the partial differential equation for the forced vibration of the beam is obtained as

$$EI \frac{\partial^4 y(x,t)}{\partial x^4} + c \frac{\partial y(x,t)}{\partial t} + \rho A \frac{\partial^2 y(x,t)}{\partial t^2} = F_p(t) + F_z(t) \quad (12)$$

where

$$F_p(t) = (m_b \ddot{y}_b(t) + m_w \ddot{y}_w(t) + (m_b + m_w)g) \delta(x - (u_0 t + \frac{1}{2} f t^2)) \quad (13)$$

and

$$F_Z(t) = \sum_{i=1}^N (c_{z_i} \dot{z}_i + k_{z_i} \ddot{z}_i) \delta(x - x_i) = - \sum_{i=1}^N (m_{z_i} \ddot{z}_i) \delta(x - x_i) \quad (14)$$

the acceleration due to gravity being g , and δ the Dirac Delta function. Considering n number of modeshapes for the damaged beam, the term $y(x,t)$ can be expressed using the technique of separation of variables as

$$y(x,t) = \sum_{j=1}^n q_j(t) \Phi_j(x) \quad (15)$$

where $q_j(t)$ is the time domain response and $\Phi_j(x)$ is the j^{th} modeshape of the beam. Using the orthogonality property of the assumed modeshapes $\Phi_n(x)$, the constant

$$K = \int_0^L \Phi_n^2(x) dx \quad (16)$$

is obtained. Following the standard technique of separating variables and then multiplying both sides of equation 12 by the modeshapes and integrating over length L a system of n number of ordinary differential equations is obtained as

$$\ddot{q}_j(t) + 2\xi_j \omega_j \dot{q}_j(t) + \omega_j^2 q_j(t) = R_j(t) \quad (17)$$

where ω_j denotes the natural frequency and ξ_j denotes the damping ratio of the beam for j^{th} mode. The forcing function $R_j(t)$ is found to be

$$R_j(t) = \frac{1}{\rho AK} \{ (m_w \ddot{y}_w + m_b \ddot{y}_b + (m_w + m_b)g) \Phi_j(u_0 t + \frac{1}{2} f t^2) - \sum_{i=1}^N (m_{zi} \ddot{z}_i) \Phi_j(x_i) \} \quad (18)$$

It is thus seen that the acceleration of the vehicle and the effects of damage both enter into the dynamic loading of the beam.

The system of equations 9, 10, 11 and 17 can be represented in a matrix form as

$$[M]\{\ddot{\tilde{y}}\} + [C]\{\dot{\tilde{y}}\} + [K]\{\tilde{y}\} = \{Q\} \quad (19)$$

where M, C and K are the mass, damping and stiffness matrices respectively the vector Q represents the dynamic loading. The elements of these matrices and the vector are given in Appendix A.2. The matrices for problems involving free vibration of the bridge with TMD and the forced and free vibration of the bridge without TMD can be obtained by suppressing the rows and columns corresponding to the degrees of freedom that are not present for the particular problem. The governing equations 9, 10, 11 and 17 can be normalized to

$$\Omega^2 \ddot{Y}_b + 2\zeta_b \Omega \gamma_f (\dot{Y}_b - \dot{Y}_w) + \gamma_f^2 (Y_b - Y_w) = 0 \quad (20)$$

$$\frac{\varepsilon_b}{\varepsilon_w} \Omega^2 \ddot{Y}_b + \Omega^2 \ddot{Y}_w + 2\zeta_w \frac{\varepsilon}{\varepsilon_w} \Omega (\dot{Y}_w + \dot{Y}) + \frac{\varepsilon}{\varepsilon_w} (Y_w + Y) = 0 \quad (21)$$

$$\Omega^2 \ddot{Z}_i + 2\zeta_{z_i} \Omega \gamma_z (\dot{Z}_i - \dot{Y}) + \gamma_z^2 (Z_i - Y) = 0 \quad (22)$$

and

$$\ddot{u}_j + 2\zeta_j \frac{\omega_j}{\omega_1} \dot{u}_j + \left(\frac{\omega_j}{\omega_1}\right)^2 u_j = \frac{1}{K} \left((\varepsilon_b \ddot{Y}_b + \varepsilon_w \ddot{Y}_w) + \frac{\varepsilon g}{y_m \omega_1^2} \right) \Phi_j(\beta_j \xi_v) - \sum_{i=1}^N \frac{\varepsilon_{z_i} g}{y_m \omega_1^2} \Phi_j(\beta_j \xi_i) \quad (23)$$

where the non-dimensional terms are given in Appendix A.3.

3.3 Importance of the First Modeshape

A numerical example is taken up to illustrate the importance of the contribution of the first modeshape of a beam for the current problem. The various material and geometric parameters are provided in Table 1. Figure 2 presents the normalized displacement, velocity and acceleration response of the midpoint of a beam with no TMD. The normalized responses reported in this paper have been carried out with respect to the peak responses (displacement, velocity and acceleration) of the bridge and the vehicle for the undamaged condition of the bridge. It is observed that the effects of the first modeshape are dominant in comparison with the higher modeshapes and thus, the control of the first modeshape can bring about a control of the peak response of the structure. It is also seen that for a beam-vehicle interaction problem, the incorporation of a single TMD at the location of the maximum of the first modeshape can ensure the control of peak response (controlling the absolute maximum values of displacement, velocity and acceleration) since the input dynamic force is narrow banded (Kwon et.al (1998), Jo et.al (2001)).

3.4 Effects of Damage

The effects of an open crack (CDR=0.35, a=18m) in the beam are seen in Figures 3(a) and 3(b) for both bridge and vehicle respectively. The introduction of damage brings about a

higher dynamic response and also distorts the frequency of the dynamic loading due to the change of the modeshape of a damaged beam in comparison with the undamaged modeshape. The response of the vehicle is observed to be accentuated more in the presence of damage than the beam itself. Also, the vertical accelerations are seen to be affected the most when compared with the displacement and velocity responses. The magnified accelerations for the different degrees of freedom can be related to passenger comfort and serviceability of the bridge is affected adversely.

4 TUNING PARAMETERS OF THE TMD

Once the location of the TMD and the system dynamics are known, the mass, the damping and the stiffness of the tuned mass damper need to be designed. The mass ratio (mass of the TMD to that of the beam), from practical considerations, is a small number usually varying from 0.5% to 4%. The damping ratio, and most importantly the stiffness of the damper need to be tuned with that of the response for effective reduction of the peak responses.

Assuming the effects of the vehicle inertia to be comparatively small in comparison to the effects of the vehicle's self weight and that the effects of the first modeshape of the beam dominate, the governing system of equations 9, 10, 11 and 17 can be reduced to the form

$$\ddot{q}_1(t) + 2\zeta_1\omega_1\dot{q}_1(t) + \omega_1^2q_1(t) = \frac{m_{z_1}}{\rho AK} (2\zeta_{z_1}\omega_{z_1}\dot{u}(t) + \omega_{z_1}^2u(t)) + \frac{P\Phi_1(u_0t + \frac{1}{2}ft^2)}{\rho AK} \quad (24)$$

and

$$\ddot{u}_1(t) + 2\zeta_{z_1}\omega_{z_1}\dot{u}_1(t) + \omega_{z_1}^2u_1(t) = -\ddot{q}_1(t) \quad (25)$$

where

$$u_1(t) = z_1(t) - y(t) \quad (26)$$

and

$$P = (m_w + m_b)g \quad (27)$$

By choosing

$$\mu = \frac{m_{z_1}}{\rho AK}, \zeta_2 = \zeta_{z_1}, \omega_2 = \omega_{z_1}, m_1 = \rho AK \quad (28)$$

and

$$f(t) = P\Phi_1(u_0 t + \frac{1}{2}ft^2) \quad (29)$$

the system of differential equations become identical to that considered by Ghosh and Basu (2006) to obtain a closed form optimal tuning criterion for a TMD.

Ghosh and Basu (2006) have considered the system of equations 24 and 25 to provide a closed form solution of the optimal tuning ratio

$$v_{opt} = \sqrt{\frac{1 - 4\zeta_1^2 - \mu(2\zeta_1^2 - 1)}{(1 + \mu)^3}} \quad (30)$$

where

$$v_{opt} = \frac{\omega_{z_1}}{\omega_1} \quad (31)$$

The authors had chosen an optimum damping ratio for the TMD to be

$$\zeta_{z_1} = \frac{\sqrt{\mu}}{2} \quad (32)$$

The optimum tuning ratio can be rearranged as

$$v_{\text{opt}} = \sqrt{\frac{1}{(1+\mu)^2} - \frac{2\zeta_1^2}{(1+\mu)^2} - \frac{2\zeta_1^2}{(1+\mu)^3}} \quad (33)$$

Expanding Binomially and neglecting higher order terms, equation 33 reduces to

$$v_{\text{opt}} = \sqrt{1 - 2\mu - 4\zeta_1^2 + 10\zeta_1^2\mu} \quad (34)$$

Neglecting the term $10\zeta_1^2\mu$ with respect to the other terms present in equation 34

$$v_{\text{opt}} = (1 - (2\mu + 4\zeta_1^2))^{\frac{1}{2}} \quad (35)$$

Expanding Binomially and neglecting the higher order terms again, the modified tuning parameter is obtained in much simpler closed form as

$$v_{\text{opt}} = 1 - \mu - 2\zeta_1^2 \quad (36)$$

It is observed that the optimal tuning as proposed by Ghosh and Basu (2006) is essentially linear in the mass ratio of the TMD and quadratic in the damping ratio of the structure for practical purposes. Figure 4 illustrates this fact by considering a range of mass ratios and damping ratios. The term ‘M’ within the parentheses of the legend in the figure denotes results obtained by the author using the modified tuning parameter in equation 36.

5. NUMERICAL RESULTS

A number of numerical examples are considered to investigate the effect of TMDs on mitigating different peak responses of the bridge and the vehicle. Figure 5 shows the effects of a single TMD at the midpoint of an undamaged beam. The geometric and material parameters of the beam are kept as in Table 1 and the mass ratio of the TMD is kept at 0.03.

Figure 6 illustrates the effects on the motion of the vehicle for the same problem. It is observed that the incorporation of a TMD might be helpful to mitigate the free vibration of the bridge and the vehicle more efficiently than the peak dynamic displacements. This aspect helps in improving the passenger comfort and the serviceability requirements of the bridge structure. Figure 7 considers the efficiency of a TMD in controlling the peak dynamics responses for an undamaged beam over a range of velocities. A comparatively better performance in reducing the peak acceleration response is observed.

The efficiency of the TMD in relation to the control of peak responses for displacement, velocity and acceleration is provided in Figures 8 and 9 for the bridge and the vehicle respectively considering the effects of various crack depth ratios and vehicle velocities. The possibility of deteriorated performance of peak vibration response control due to mistuning of the TMD in presence of damage is identified for comparatively large crack depth ratios within a certain velocity range. The effectiveness of the TMD in terms of percentage reduction of peak responses is found to be significant in the case of controlling the

vertical accelerations of the vehicle (Figure 9). Consequently, the TMD is seen to be effective in terms of passenger comfort and in possibly relieving some amount of stress to the vehicle suspension system.

Parametric investigations of the effects of acceleration of the vehicle are carried out next for various damage conditions. The results of the control of the peak responses are given in Table 2. Cases are observed where the incorporation of a TMD cannot control the peak responses or where it reduces the peak responses insignificantly when an accelerating vehicle is present on the bridge.

The optimum tuning ratio of the damaged beam gets modified in the presence of damage and the natural frequency ratio of a damaged beam (ratio of the natural frequency of the damaged beam to the natural frequency of the undamaged beam) acts as the modification factor. The optimum tuning ratios for different CDR and lengths of the beam are provided in Table 3.

6. CONCLUSIONS

The paper considers a damaged bridge - accelerating vehicle interaction problem where the damage is modelled as an open crack. The incorporation of a TMD to mitigate the peak vibration response of the bridge and the vehicle has been investigated in terms of vertical displacement, velocity and acceleration. A simplified form of the Ghosh-Basu (2006) tuning criterion for the tuning ratio of the TMD is proposed. A detail parametric study is performed on the system with TMD considering the effects of vehicle velocities, the severity of the damage and the vehicle accelerations. Conditions and effects of possible detuning with respect to the efficiency of peak response reduction for a deteriorating of the bridge are identified. The control of the vibration of the two vertical modes of the quarter car vehicle traversing the damaged beam is found to be higher even in the presence of damage in

comparison with that of the bridge. However, more studies are needed incorporating vehicle models of higher degrees of freedom to reach any conclusive statement in this regard. The presence of vehicle acceleration is observed to affect the performance of the TMD significantly.

REFERENCES

Abdel –Rohman, M. and Al-Duaij, J. (1996). “Dynamic Response of a Hinged-Hinged Single Span Bridges with Uneven Deck”. *Computers and Structures*, 59, 291-299.

Abe, M and Fujino, Y. (1994). “Dynamic Characterization of Multiple Tuned Mass Dampers and Some Design Formulas”, *Earthquake Engineering and Structural Dynamics*, Vol. 23, 813-835.

Cai, Y., Chen S.S., Rote, D.M and Coffey H.T. (1994). “Vehicle/guideway Interaction for High Speed Vehicles on a Flexible Guideway”, *Journal of Sound and Vibration*, 175(5), 625-646.

Carneiro, S.H.S and Inman, D.J.(2002). “Continuous Model for the Transverse Vibration of Cracked Timoshenko Beams”. *Transactions of the ASME, Journal of Vibration and Acoustics*, Vol. 24, 310-320

Da Silva, J.G.S. (2004). ”Dynamical Performance of Highway Bridge Decks with Irregular Pavement Surface”. *Computers and Structures*, 82, 871-881.

Delgado, R.M. and S.M. dos Santos, R.C. (1997). “Modelling of a Railway Bridge-Vehicle Interaction on High Speed Tracks”. *Computers and Structures*, 63, 511-523.

Fryba, L. (1999). “Vibrations of Solids and Structures under Moving Loads”, *Thomas Telford, London*.

Genin, J., Ginsberg J.H and Ting EC. (1975). "A complete formulation of inertial effects in the guideway vehicle interaction problem", *Journal of Sound and Vibration*, 38, 15-26.

Ghosh, A and Basu, B. (2006). "A Closed Form Optimal Tuning Criterion for TMD in Damped Structures". *Structural Control and Health Monitoring*, In Press, DOI: 10.1002/stc.176.

Hartog, D. (1985) "Mechanical Vibration". *Dover Publications, New York*.

Hayashikawa, T and Watanabe, N. (1981). "Dynamic Behaviour of Continuous Beams with Moving Loads", *Journal Of Engineering Mechanics Division, ASCE*, 107(EMI), 229-246.

Igusa, T and Xu, K(1992). "Dynamic Characteristics of Multiple Tuned Mass Substructures with Closely Spaced Frequencies", *Earthquake Engineering and Structural Dynamics*, Vol. 21, 1050-1070.

Inman DJ. (2001). "Engineering Vibration". *Prentice Hall, New Jersey*.

Jo, B.W., Tae, G.H and Lee, D.W. (2001). "Structural Vibration of Tuned Mass Damper Installed Three Span Steel Box Bridge", *International Journal of Pressure Vessels and Piping*, 78, 667-675.

Kareem, A and Kline, S (1995). "Performance of Multiple Mass Dampers under Random Loading", *Journal of Structural Engineering*, Vol. 121, 348-361.

Klasztorny, M and Langer, J. (1990). “Dynamic Response of Single Span Bridges to a Series of Moving Loads”, *Earthquake Engineering and Structural Dynamics*, 19(8), 1107-1124.

Kwon, H.C., Kim, M.C and Lee, I.W. (1998). “Vibration Control of Bridges Under Moving Loads”, *Computers & Structures*, Vol 66(4), 473-480.

Law, S.S and Zhu, X.Q. (2004). “Dynamic Behaviour of Damaged Concrete Bridge Structures under Moving Vehicular Loads”. *Engineering Structures*, 26, 1279-1293.

Lee, J.W., Kim, J.D., Yun, C.B., Yi, J.H. and Shim, J.M. (2002). “ Health Monitoring Method for Bridges Under Ordinary Traffic Loadings”. *Journal of Sound and Vibration*, 257(2), 247-264.

Majumdar, L. and Manohar C.S. (2003). “ A Time-Domain Approach for Damage Detection in Beam Structures Using Vibration Data with a Moving Oscillator as an Excitation Source”. *Journal of Sound and Vibration*, 268, 699-716.

MATLAB. (1994). “Users Manual “. The Mathworks Inc. 3 Apple Hill Drive, Natick, MA, USA.

Narkis Y. (1994). “Identification of Crack Location in Vibrating Simply Supported Beams”. *Journal of Sound and Vibration*, 172(4), 549-558.

Pesterev, A.V. and Bergman, L.A. (1997). “Vibration of Elastic Continuum Carrying Accelerating Oscillator”. *ASCE Journal of Engineering Mechanics*, 886-889.

Song, M.K., Noh, H.C. and Choi, C.K. (2003). “A New Three Dimensional Finite Element Analysis Model of High-Speed Train-Bridge Interactions”. *Engineering Structures*, 25, 1611-1626.

Tsai, H.C. (1993). “Green’s Function of Support Excited Structures with Tuned Mass Dampers Derived by a Perturbation Method”, *Earthquake Engineering and Structural Dynamics*, 22(11), 975-990.

Wang, J.F., Lin, C.C and Chen B.L.(2003). “Vibration suppression for high-speed railway bridges using tuned mass dampers”, *International Journal of Solids and Structures*, Vol. 40, 465–491.

Warburton, G.B and Ayorinde, E.O. (1980). “Optimal dynamic vibration absorbers for general beam systems”, *Earthquake Engineering and Structural Dynamics*,8, 197-217.

Yamaguchi, H and Harnpornchai, N.(1993). “Fundamental Characteristics of Multiple Tuned Mass Dampers for Suppressing Harmonically Forced Oscillations”, *Earthquake Engineering and Structural Dynamics*, Vol. 22, 51-62.

Yang, Y.B. and Lin C.W. (2005). “Vehicle-Bridge Interaction Dynamics and Potential Applications”. *Journal of Sound and Vibration*, 284, 205-226.

APPENDIX A.1

Linear system of equations with unknown coefficients in modeshape matrix for lumped crack model.

$$\begin{pmatrix} C_{1L} \\ C_{2L} \\ C_{3L} \\ C_{4L} \\ C_{1R} \\ C_{2R} \\ C_{3R} \\ C_{4R} \end{pmatrix} \begin{pmatrix} 0 & 1 & 0 & 1 & 0 & 0 & 0 & 0 \\ 0 & 0 & 0 & 0 & \sin(\lambda L) & \cos(\lambda L) & \sinh(\lambda L) & \cosh(\lambda L) \\ 0 & -1 & 0 & 1 & 0 & 0 & 0 & 0 \\ 0 & 0 & 0 & 0 & -\sin(\lambda L) & -\cos(\lambda L) & \sinh(\lambda L) & \cosh(\lambda L) \\ \sin(\lambda a) & \cos(\lambda a) & \sinh(\lambda a) & \cosh(\lambda a) & -\sin(\lambda a) & -\cos(\lambda a) & -\sinh(\lambda a) & -\cosh(\lambda a) \\ -\sin(\lambda a) & -\cos(\lambda a) & \sinh(\lambda a) & \cosh(\lambda a) & \sin(\lambda a) & \cos(\lambda a) & -\sinh(\lambda a) & -\cosh(\lambda a) \\ -\cos(\lambda a) & \sin(\lambda a) & \cosh(\lambda a) & \sinh(\lambda a) & \cos(\lambda a) & -\sin(\lambda a) & -\cosh(\lambda a) & -\sinh(\lambda a) \\ -\cos(\lambda a) & \sin(\lambda a) & -\cosh(\lambda a) & -\sinh(\lambda a) & \cos(\lambda a) + \theta L \lambda \sin(\lambda a) & -\sin(\lambda a) + \theta L \lambda \cos(\lambda a) & \cosh(\lambda a) - \theta L \lambda \sinh(\lambda a) & \sinh(\lambda a) - \theta L \lambda \cosh(\lambda a) \end{pmatrix} = \begin{pmatrix} 0 \\ 0 \\ 0 \\ 0 \\ 0 \\ 0 \\ 0 \\ 0 \end{pmatrix}$$

APPENDIX A.2

Matrix Elements of Equation 19.

Mass Matrix.

$$[M] = \begin{bmatrix}
 m_b & 0 & 0 & 0 & \dots & 0 & 0 & 0 & \dots & 0 \\
 m_b & m_w & 0 & 0 & \dots & 0 & 0 & 0 & \dots & 0 \\
 0 & 0 & m_{z_1} & 0 & \dots & 0 & 0 & 0 & \dots & 0 \\
 0 & 0 & 0 & m_{z_2} & \dots & 0 & 0 & 0 & \dots & 0 \\
 \cdot & \cdot & \cdot & \cdot & \dots & 0 & \cdot & \cdot & \dots & \cdot \\
 \cdot & \cdot & \cdot & \cdot & \dots & 0 & \cdot & \cdot & \dots & \cdot \\
 0 & 0 & 0 & 0 & \dots & m_{z_N} & 0 & 0 & \dots & 0 \\
 \frac{-m_b}{\rho AK} \Phi_1(u_0 t + \frac{1}{2} ft^2) & \frac{-m_w}{\rho AK} \Phi_1(u_0 t + \frac{1}{2} ft^2) & \frac{m_{z_1}}{\rho AK} \Phi_1(x_1) & \frac{m_{z_2}}{\rho AK} \Phi_1(x_2) & \dots & \frac{m_{z_N}}{\rho AK} \Phi_1(x_N) & 1 & 0 & \dots & 0 \\
 \frac{-m_b}{\rho AK} \Phi_2(u_0 t + \frac{1}{2} ft^2) & \frac{-m_w}{\rho AK} \Phi_2(u_0 t + \frac{1}{2} ft^2) & \frac{m_{z_1}}{\rho AK} \Phi_2(x_1) & \frac{m_{z_2}}{\rho AK} \Phi_2(x_2) & \dots & \frac{m_{z_N}}{\rho AK} \Phi_2(x_N) & 0 & 1 & 0 & \dots & 0 \\
 \cdot & \cdot & \cdot & \cdot & \dots & \cdot & \cdot & \cdot & \dots & \cdot \\
 \cdot & \cdot & \cdot & \cdot & \dots & \cdot & \cdot & \cdot & \dots & \cdot \\
 \cdot & \cdot & \cdot & \cdot & \dots & \cdot & \cdot & \cdot & \dots & \cdot \\
 \cdot & \cdot & \cdot & \cdot & \dots & \cdot & \cdot & \cdot & \dots & \cdot \\
 \frac{-m_b}{\rho AK} \Phi_n(u_0 t + \frac{1}{2} ft^2) & \frac{-m_w}{\rho AK} \Phi_n(u_0 t + \frac{1}{2} ft^2) & \frac{m_{z_1}}{\rho AK} \Phi_n(x_1) & \frac{m_{z_2}}{\rho AK} \Phi_n(x_2) & \dots & \frac{m_{z_N}}{\rho AK} \Phi_n(x_N) & 0 & 0 & \dots & 1
 \end{bmatrix}$$

Damping Matrix.

$$[C] = \begin{bmatrix} c_b & -c_b & 0 & 0 & \dots & 0 & 0 & 0 & \dots & 0 \\ 0 & c_w & 0 & 0 & \dots & 0 & c_w \Phi_1(u_0 t + \frac{1}{2} ft^2) & c_w \Phi_2(u_0 t + \frac{1}{2} ft^2) & \dots & c_w \Phi_n(u_0 t + \frac{1}{2} ft^2) \\ 0 & 0 & c_{z_1} & 0 & \dots & 0 & -c_{z_1} \Phi_1(x_1) & -c_{z_1} \Phi_2(x_1) & \dots & -c_{z_1} \Phi_n(x_1) \\ 0 & 0 & 0 & c_{z_2} & \dots & 0 & -c_{z_2} \Phi_1(x_2) & -c_{z_2} \Phi_2(x_2) & \dots & -c_{z_2} \Phi_n(x_2) \\ \cdot & \cdot & \cdot & \cdot & \dots & 0 & \cdot & \cdot & \dots & \cdot \\ \cdot & \cdot & \cdot & \cdot & \dots & 0 & \cdot & \cdot & \dots & \cdot \\ 0 & 0 & 0 & 0 & \dots & c_{z_N} & -c_{z_N} \Phi_1(x_N) & -c_{z_N} \Phi_2(x_N) & \dots & -c_{z_N} \Phi_n(x_N) \\ 0 & 0 & 0 & 0 & \dots & 0 & 2\xi_1 \omega_1 & 0 & \dots & 0 \\ 0 & 0 & 0 & 0 & \dots & 0 & 0 & 2\xi_2 \omega_2 & \dots & 0 \\ \cdot & \cdot & \cdot & \cdot & \dots & \cdot & \cdot & \cdot & \dots & \cdot \\ \cdot & \cdot & \cdot & \cdot & \dots & \cdot & \cdot & \cdot & \dots & \cdot \\ \cdot & \cdot & \cdot & \cdot & \dots & \cdot & \cdot & \cdot & \dots & \cdot \\ \cdot & \cdot & \cdot & \cdot & \dots & \cdot & \cdot & \cdot & \dots & \cdot \\ 0 & 0 & 0 & 0 & \dots & 0 & 0 & 0 & \dots & 2\xi_n \omega_n \end{bmatrix}$$

Stiffness Matrix.

$$[\mathbf{K}] = \begin{bmatrix}
 k_b & -k_b & 0 & 0 & \dots & 0 & 0 & 0 & \dots & 0 \\
 0 & k_w & 0 & 0 & \dots & 0 & k_w \Phi_1(u_0 t + \frac{1}{2} ft^2) & k_w \Phi_2(u_0 t + \frac{1}{2} ft^2) & \dots & k_w \Phi_n(u_0 t + \frac{1}{2} ft^2) \\
 0 & 0 & k_{z_1} & 0 & \dots & 0 & -k_{z_1} \Phi_1(x_1) & -k_{z_1} \Phi_2(x_1) & \dots & -k_{z_1} \Phi_n(x_1) \\
 0 & 0 & 0 & k_{z_2} & \dots & 0 & -k_{z_2} \Phi_1(x_2) & -k_{z_2} \Phi_2(x_2) & \dots & -k_{z_2} \Phi_n(x_2) \\
 \dots & \dots & \dots & \dots & \dots & 0 & \dots & \dots & \dots & \dots \\
 \dots & \dots & \dots & \dots & \dots & 0 & \dots & \dots & \dots & \dots \\
 0 & 0 & 0 & 0 & \dots & k_{z_N} & -k_{z_N} \Phi_1(x_N) & -k_{z_N} \Phi_2(x_N) & \dots & -k_{z_N} \Phi_n(x_N) \\
 0 & 0 & 0 & 0 & \dots & 0 & \omega_1^2 & 0 & \dots & 0 \\
 0 & 0 & 0 & 0 & \dots & 0 & 0 & \omega_2^2 & \dots & 0 \\
 \dots & \dots & \dots & \dots & \dots & \dots & \dots & \dots & \dots & \dots \\
 \dots & \dots & \dots & \dots & \dots & \dots & \dots & \dots & \dots & \dots \\
 \dots & \dots & \dots & \dots & \dots & \dots & \dots & \dots & \dots & \dots \\
 \dots & \dots & \dots & \dots & \dots & \dots & \dots & \dots & \dots & \dots \\
 0 & 0 & 0 & 0 & \dots & 0 & 0 & 0 & \dots & \omega_n^2
 \end{bmatrix}$$

Vector of Dynamic Forces.

$$Q(t) = \left\{ \begin{array}{c} 0 \\ 0 \\ 0 \\ 0 \\ \cdot \\ \cdot \\ 0 \\ \frac{1}{\rho AK} ((m_b + m_w)g\Phi_1(u_0t + \frac{1}{2}ft^2)) \\ \frac{1}{\rho AK} ((m_b + m_w)g\Phi_2(u_0t + \frac{1}{2}ft^2)) \\ \cdot \\ \cdot \\ \cdot \\ \cdot \\ \cdot \\ \frac{1}{\rho AK} ((m_b + m_w)g\Phi_n(u_0t + \frac{1}{2}ft^2)) \end{array} \right\}$$

APPENDIX A.3

Non-Dimensional Parameters for Equations 20, 21, 22 and 23

$$y_m = \frac{(m_w + m_b)g}{\rho AL\omega_1^2} \quad (\text{A.3-1})$$

$$\tau = t\omega_1 \quad (\text{A.3-2})$$

$$Y_b = \frac{y_b}{y_m}, Y_w = \frac{y_w}{y_m}, Y = \frac{y}{y_m}, Z_i = \frac{z_i}{y_m}, u_j = \frac{q_j}{y_m} \quad (\text{A.3-3})$$

$$\xi_v = \frac{u_0 t + \frac{1}{2}ft^2}{L}, \xi_i = \frac{x_i}{L} \quad (\text{A.3-4})$$

$$\beta_j = \lambda_j L = \sqrt[4]{\frac{\rho A \omega_j^2}{EI}} L \quad (\text{A.3-5})$$

$$\varepsilon_b = \frac{m_b}{\rho AL}, \varepsilon_w = \frac{m_w}{\rho AL}, \varepsilon = \frac{m_b + m_w}{\rho AL}, \varepsilon_{z_i} = \frac{m_{z_i}}{\rho AL} \quad (\text{A.3-6})$$

$$\Omega = \frac{\omega_1}{\omega_w}, \gamma_f = \frac{\omega_b}{\omega_w}, \gamma_{z_i} = \frac{\omega_{z_i}}{\omega_w} \quad (\text{A.3-7})$$

$$\zeta_b = \frac{c_b}{2m_b\omega_b}, \zeta_w = \frac{c_w}{2(m_w + m_b)\omega_w}, \zeta_{z_i} = \frac{c_{z_i}}{2m_{z_i}\omega_{z_i}} \quad (\text{A.3-8})$$

LIST OF TABLES

Table 1- Parameters for Bridge-Vehicle Interaction Problem.

Table 2- Efficiency of TMD for Different Accelerations and Damage Conditions.

Table 3- Optimal Tuning Ratio for Different Lengths and Damage Conditions.

Vehicle	$m_b=5000$ kg $m_w=35000$ kg	$c_b=6 \times 10^4$ N-s/m $c_w=6 \times 10^4$ N-s/m	$k_b=5.1 \times 10^6$ N/m $k_w=9.6 \times 10^6$ N/m	$u_0=80$ kmph $f=0$ m/s ²
Bridge	$A=9.22$ m ² $I=1.5$ m ⁴ $L=45$ m	$\rho=2 \times 10^3$ kg/m ³ $E=35 \times 10^9$ N/m ²	$CDR=0$ $a=18$ m	$\zeta_j=0.03\%$

Table 1.

Control of Peak Response (%)	Vehicle Acceleration (m/s ²)		q(t)			y _b			y _w		
			CDR			CDR			CDR		
		0	0.2	0.3	0	0.2	0.3	0	0.2	0.3	
	1	-0.03495	-0.03337	-0.03868	-0.03487	-0.08005	-0.04505	-0.03488	-0.08006	-0.04507	
Displacement	2	0.020872	-0.04636	-0.12765	0.048473	-0.01318	-0.11434	0.041586	-0.01979	-0.12078	
	3	0.083108	-0.07235	-0.19001	0.14439	-0.02612	-0.19487	0.13082	-0.03269	-0.18879	
	1	0.066431	0.91625	-0.22468	-0.43848	1.0212	3.2005	-0.16494	1.1825	2.8297	
Velocity	2	-0.20849	-2.9628	-3.9382	-0.03361	-1.3731	0.28146	-0.08422	-1.5163	0.048713	
	3	-0.22374	2.1191	3.835	0.79802	1.3381	1.0004	0.5202	0.53001	1.1838	
	1	2.791	12.121	3.5986	-0.20532	-2.7033	-2.1517	0.10291	0.99154	-2.0144	
Acceleration	2	5.244	6.9331	7.9307	-0.26767	-2.9771	-1.6226	-0.26836	-4.8739	0.29795	
	3	4.3636	4.3588	7.246	-0.52783	4.4511	-4.5453	-0.49894	3.8571	6.5294	

Table 2.

				L=45m						L=15M				
CDR	0.05	0.1	0.15	0.2	0.25	0.3	0.35	0.05	0.1	0.15	0.2	0.25	0.3	0.35
v	0.9691	0.9691	0.9691	0.9691	0.9691	0.9691	0.9691	0.9691	0.9691	0.9691	0.9691	0.9691	0.9691	0.9691
v _m	0.9632	0.9579	0.9527	0.9471	0.9406	0.9327	0.9226	0.9517	0.9365	0.9221	0.9071	0.8902	0.8703	0.8462

Table 3.

LIST OF FIGURES

Figure 1- Schematic diagram of Bridge-Vehicle-TMD system.

Figure 2- Normalized Response of the Beam.

Figure 3(a)-Normalized Response of Beam due to Damage.

Figure 3(b)- Normalized Response of Vehicle due to Damage in Beam.

Figure 4-Comparison of Ghosh-Basu Tuning Ratio versus Proposed Simplified Tuning Ratio.

Figure 5- Effects of TMD on the Various Responses of the Beam.

Figure 6- Effects of TMD on the Various Responses of the Vehicle.

Figure 7- Peak Response Control of the Beam for Different Velocities of the Vehicle.

Figure 8- Peak Response Control of the Beam for Different Velocities and Damage Conditions.

Figure 9- Peak Response Control of the Vehicle for Different Velocities and Damage Conditions.

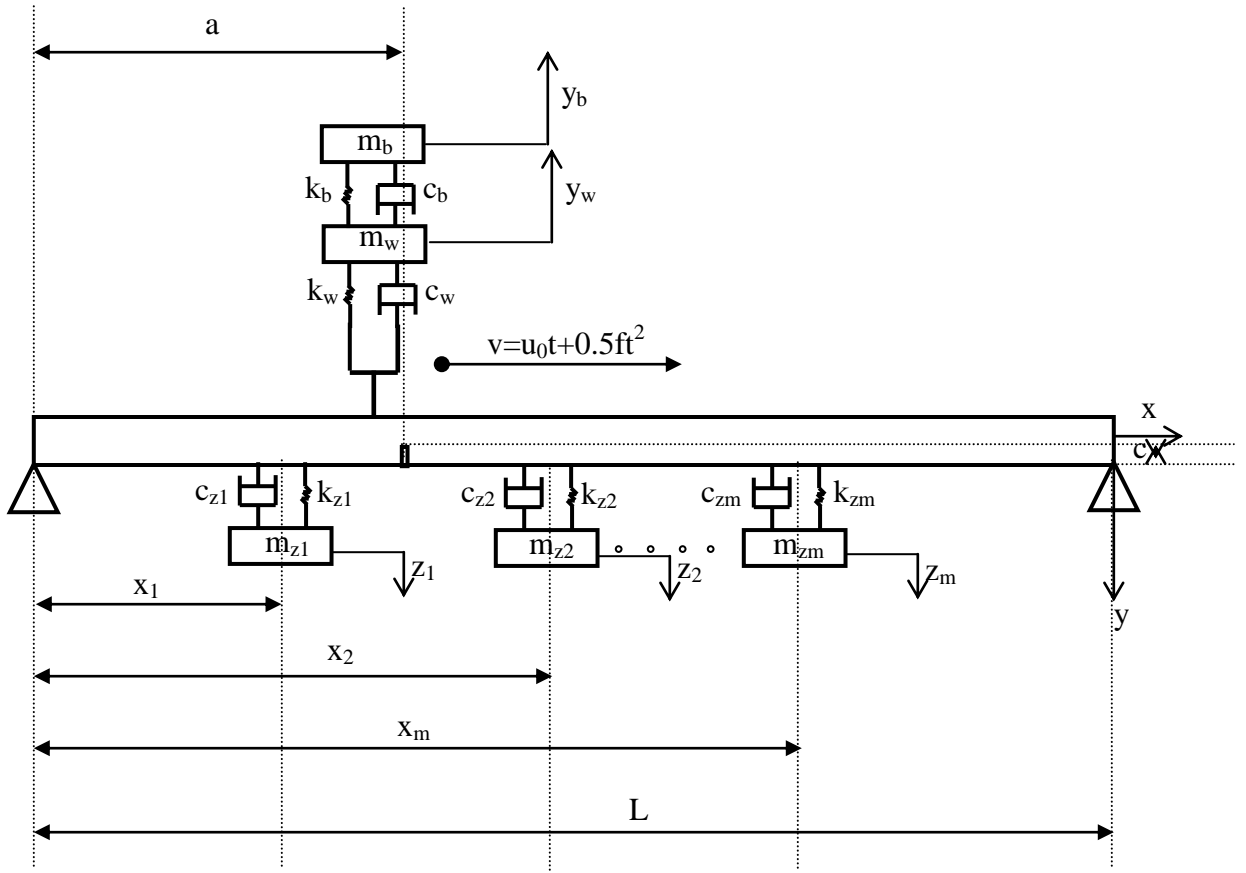

Figure 1.

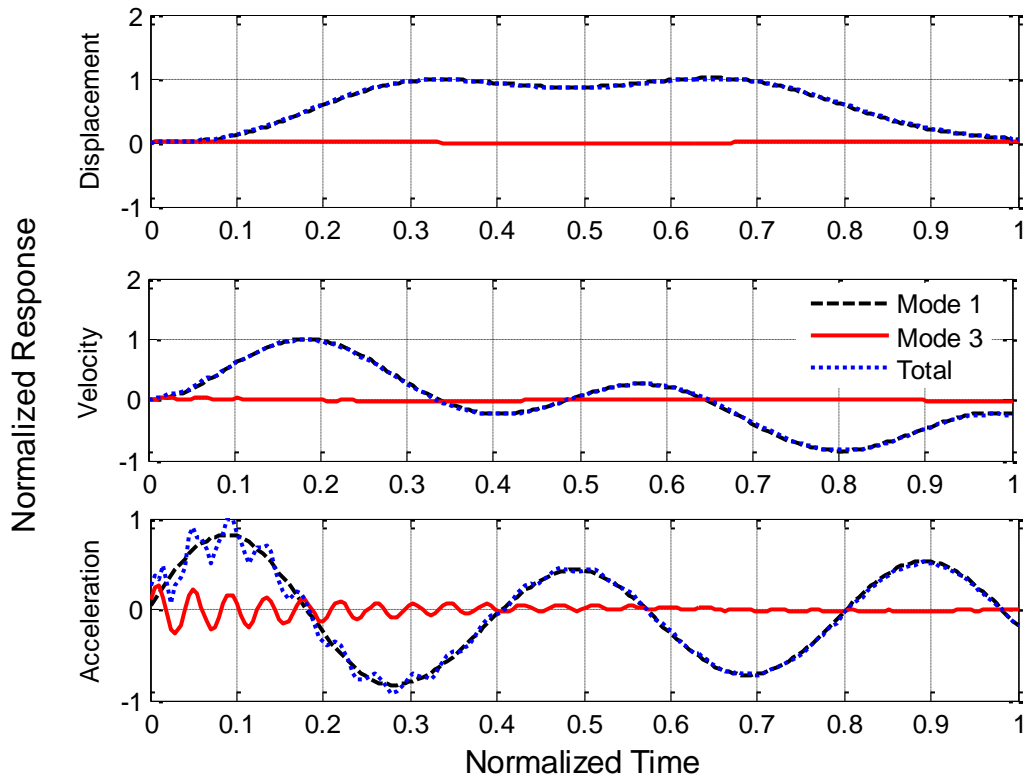

Figure 2.

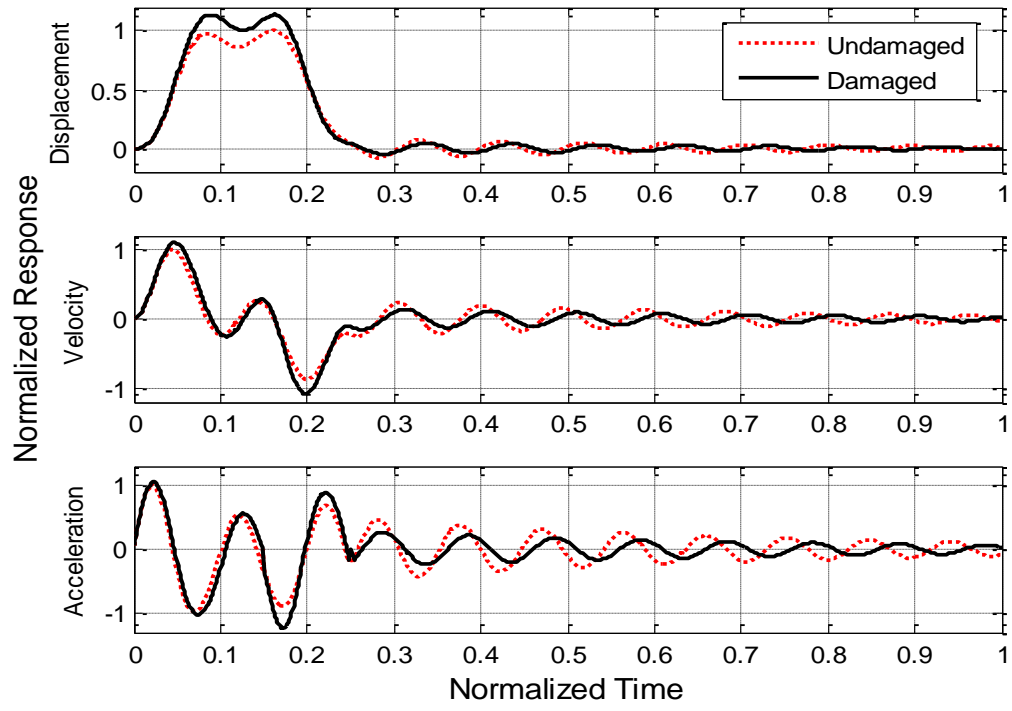

Figure 3(a).

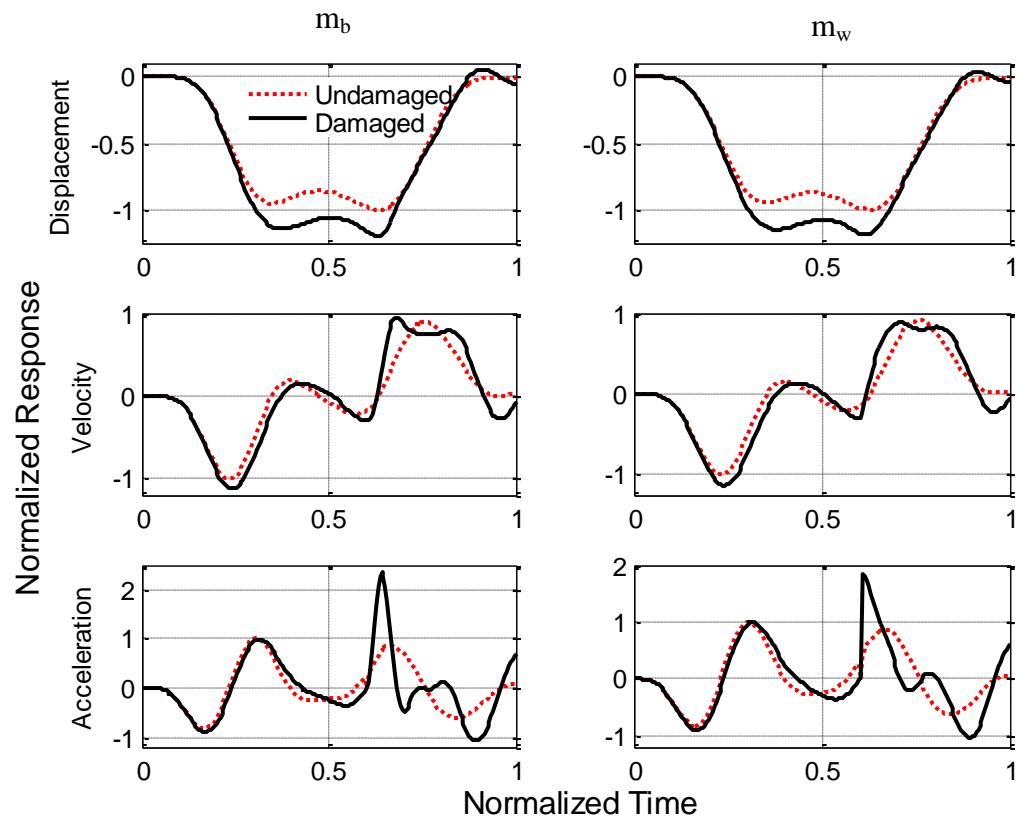

Figure 3(b).

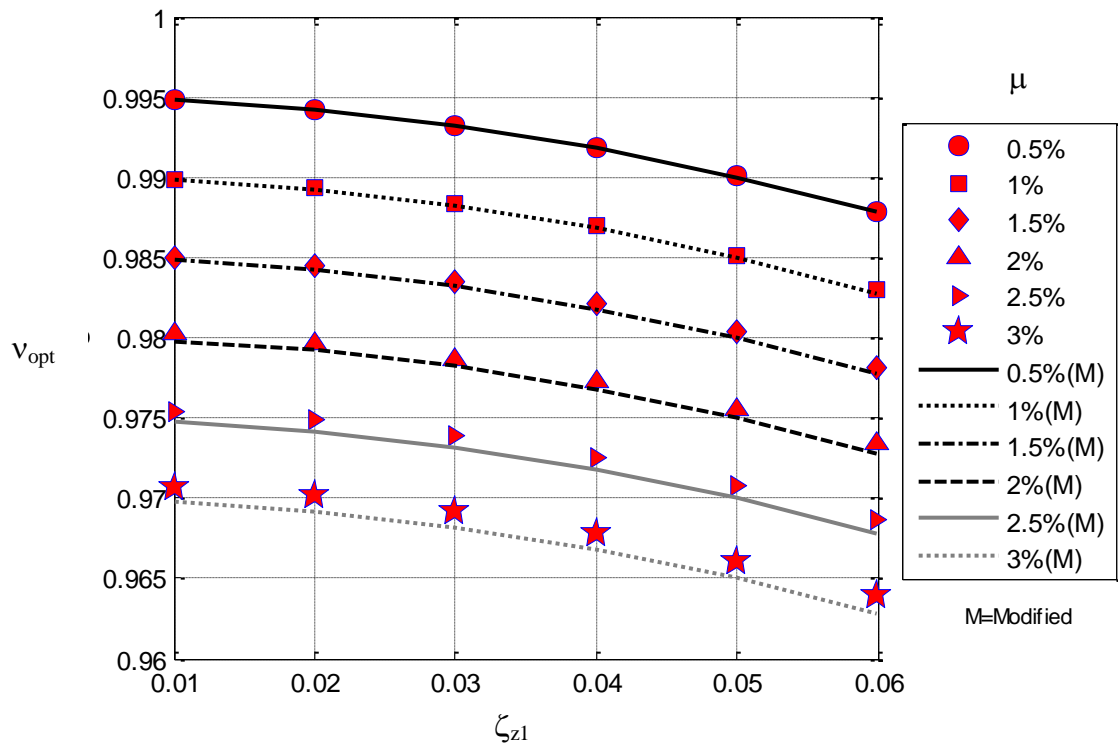

Figure 4.

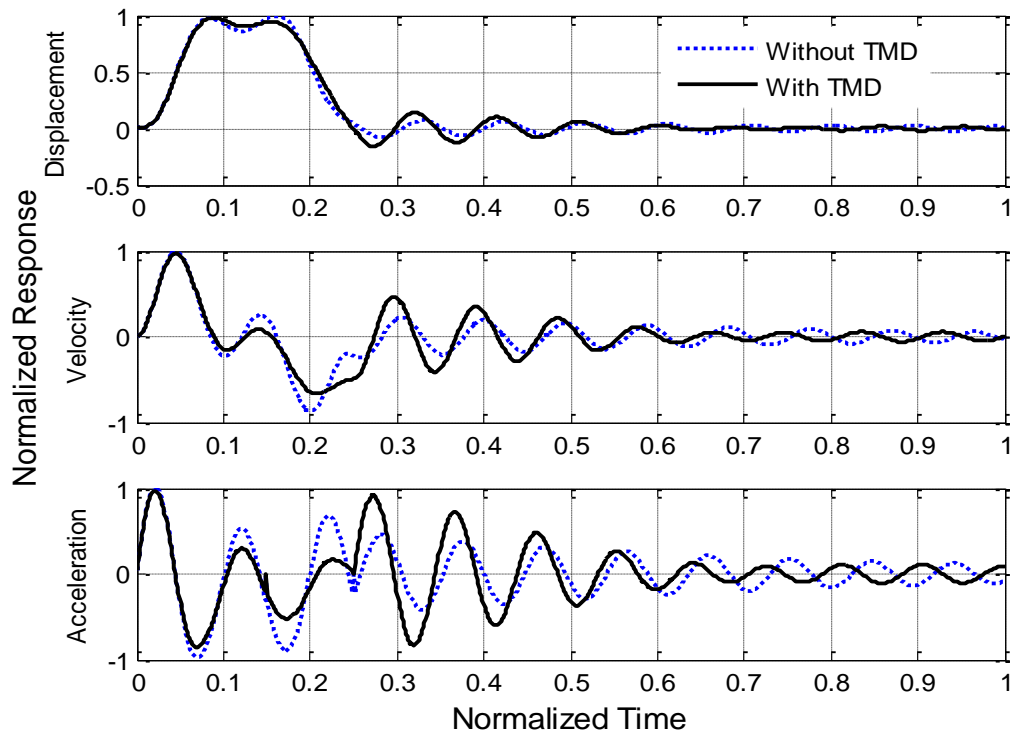

Figure 5.

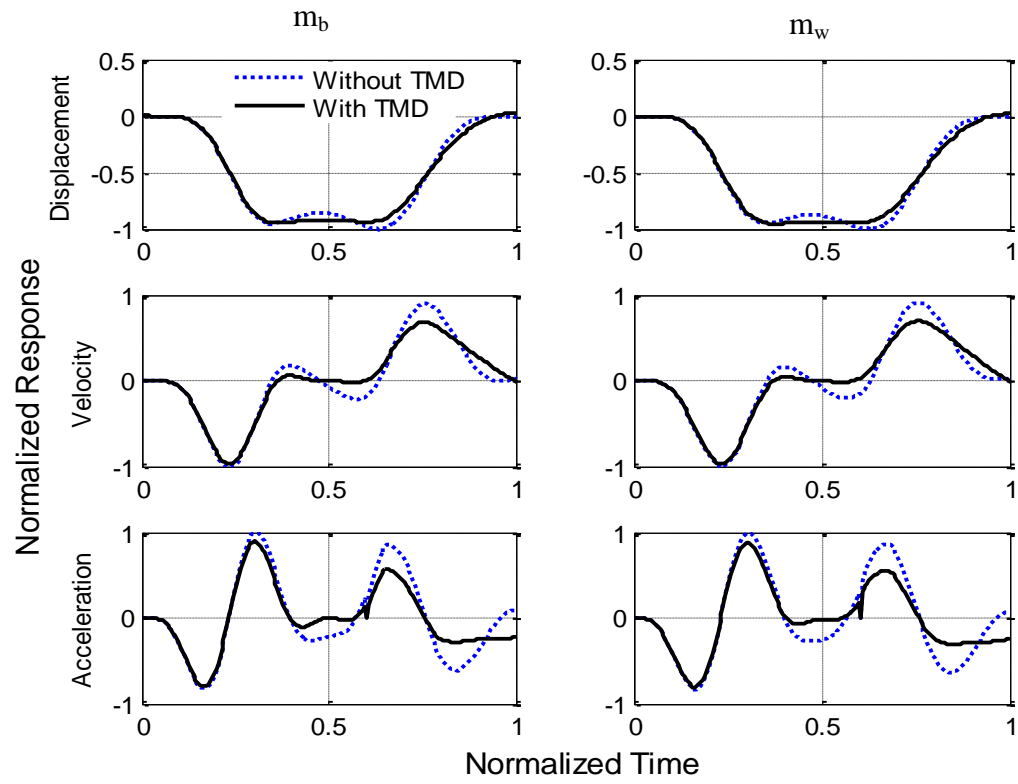

Figure 6.

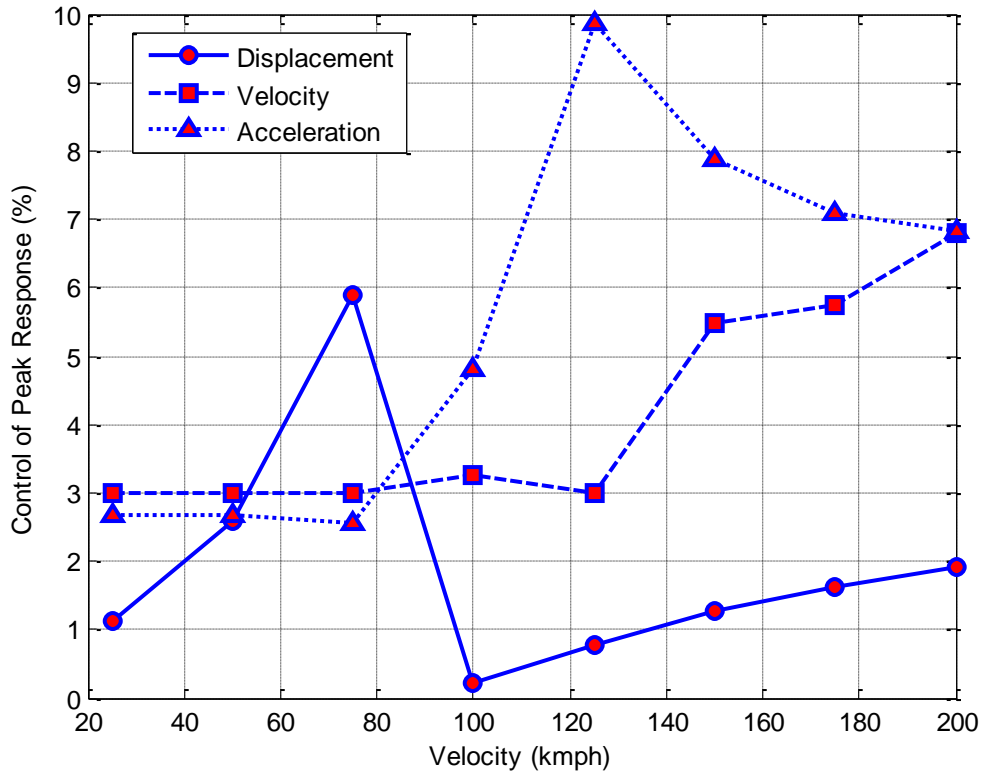
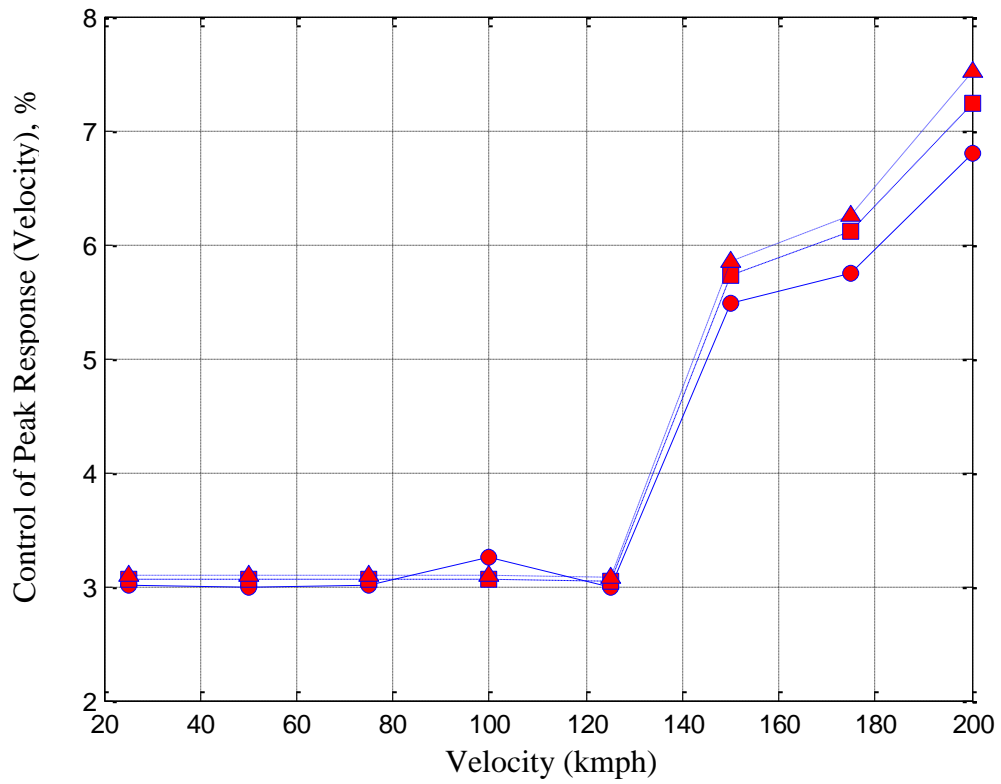
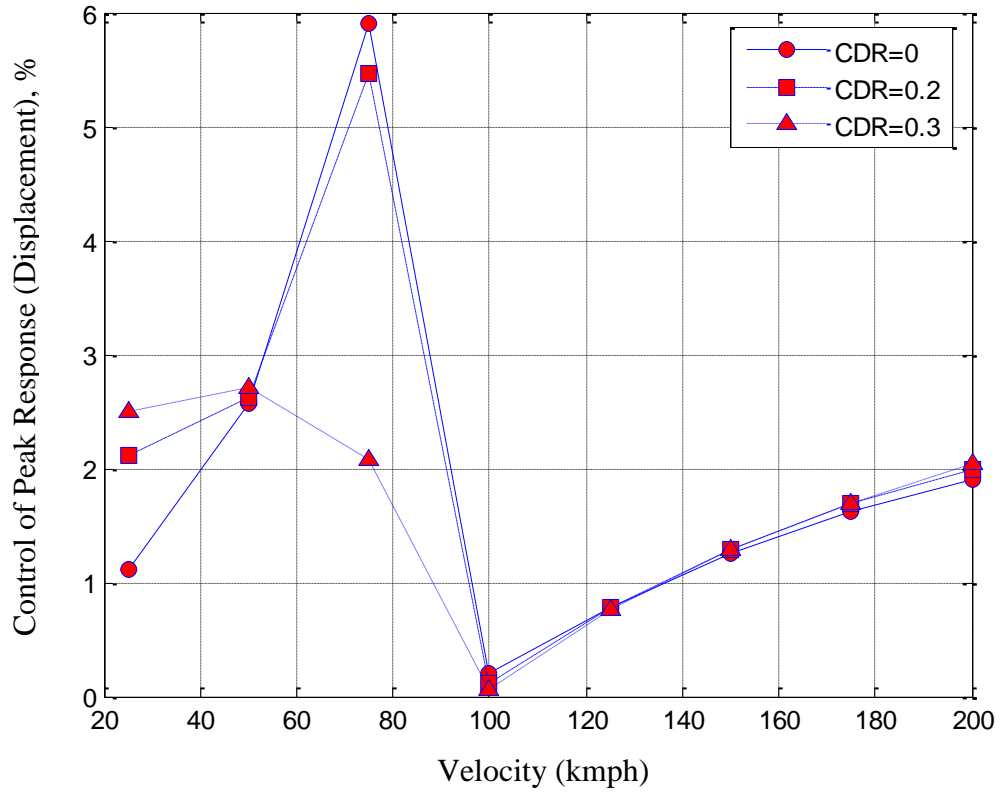

Figure 7.



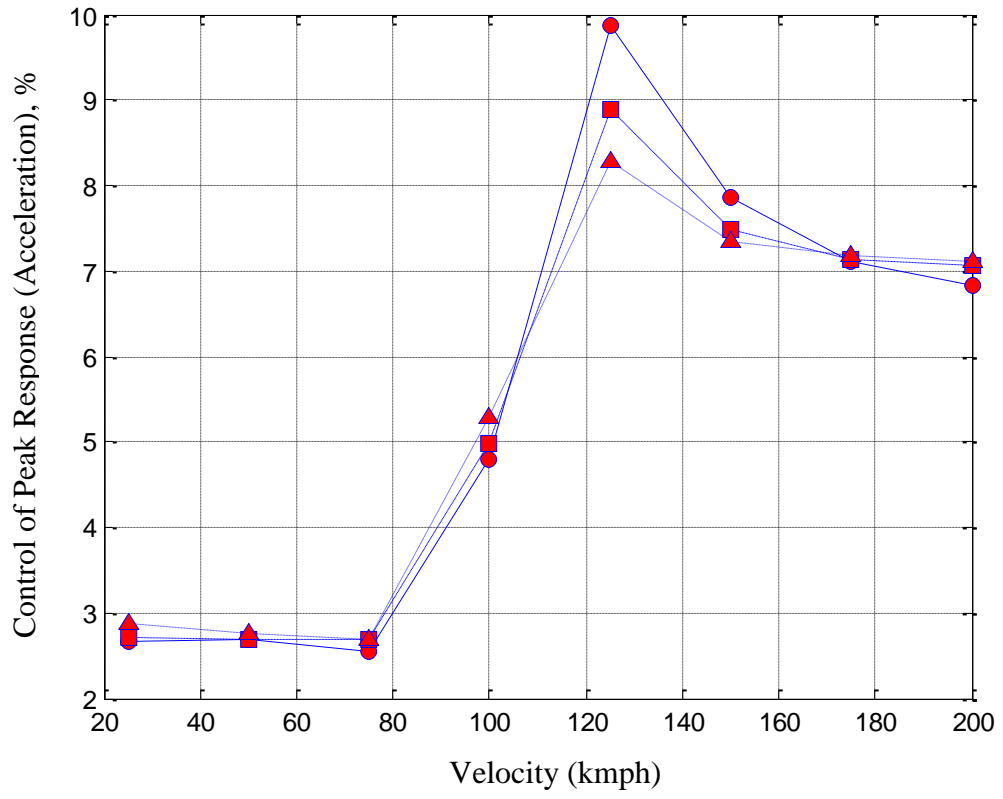
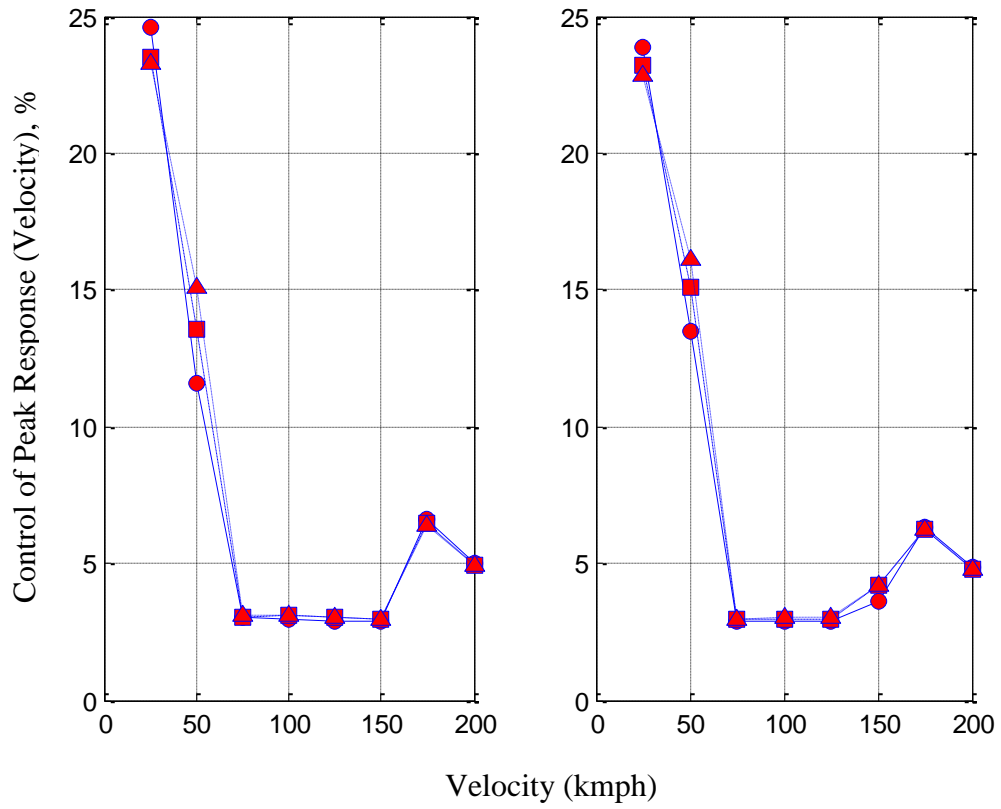
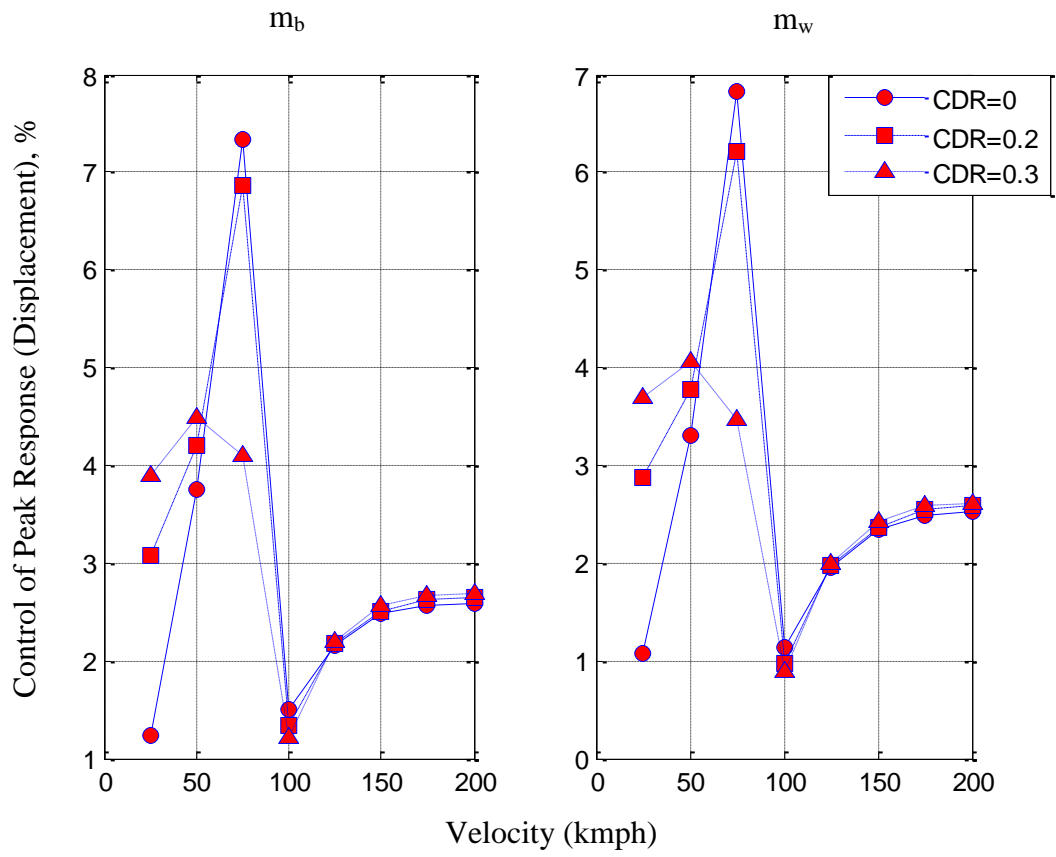

Figure 8.



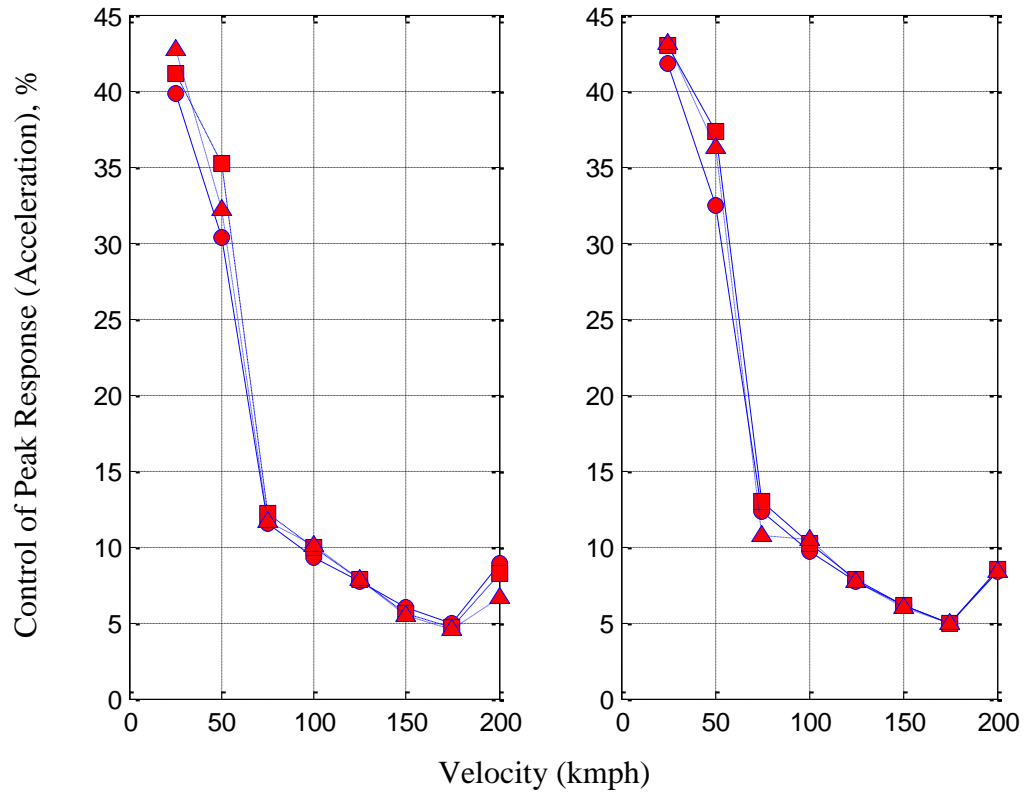

Figure 9.